



PDHonline Course C338 (4 PDH)

Signalized Intersections Part II – Project Process and Analysis

Instructor: Vincent D. Reynolds, MBA, PE

2020

PDH Online | PDH Center

5272 Meadow Estates Drive
Fairfax, VA 22030-6658
Phone: 703-988-0088
www.PDHonline.com

An Approved Continuing Education Provider

SIGNALIZED INTERSECTIONS: INFORMATIONAL GUIDE



U.S. Department of Transportation
Federal Highway Administration

Publication No.
FHWA-HRT-04-091

FOREWORD

This report complements the American Association of State Highway and Transportation Officials (AASHTO) Strategic Highway Safety Plan to develop guidance on safety of nonsignalized and signalized intersections. The goal is to reduce the annual number of highway deaths. This guide is a comprehensive document that contains methods for evaluating the safety and operations of signalized intersections and tools to remedy deficiencies. The treatments in this guide range from low-cost measures such as improvements to signal timing and signage, to high-cost measures such as intersection reconstruction or grade separation. Topics covered include fundamental principles of user needs, geometric design, and traffic design and operation; safety and operational analysis techniques; and a wide variety of treatments to address existing or projected problems, including individual movements and approaches, pedestrian and bicycle treatments, and corridor techniques. It also includes coverage of alternative intersection forms that improve intersection performance through the use of indirect left turns and other treatments. Each treatment includes a discussion of safety, operational performance, multimodal issues, and physical and economic factors that the practitioner should consider. Although the guide has considerable focus on high-volume signalized intersections, many treatments also are applicable for lower volume intersections. The information contained in this guide is based on the latest research on available treatments and best practices in use by jurisdictions across the United States. Additional resources and references are highlighted for the student, practitioner, researcher, or decisionmaker who wishes to learn more about a particular subject.

Copies of this report may be obtained from the Research and Technology Report Center, 9701 Philadelphia Court, Unit Q, Lanham, MD 20706; telephone: 301-577-0818; fax: 301-577-1421; or the National Technical Information Service (NTIS), 5285 Port Royal Road, Springfield, VA 22161; telephone: 703-487-4650; fax: 703-321-8547.

Michael F. Trentacoste
Director
Office of Safety Research and Development

NOTICE

This document is disseminated under the sponsorship of the U.S. Department of Transportation in the interest of information exchange. The U.S. Government assumes no liability for its contents or use thereof. This report does not constitute a standard, specification, or regulation.

The U.S. Government does not endorse products or manufacturers. Trade and manufacturers' names appear in this report only because they are considered essential to the object of this document.

QUALITY ASSURANCE STATEMENT

The Federal Highway Administration (FHWA) provides high-quality information to serve Government, industry, and the public in a manner that promotes public understanding. Standards and policies are used to ensure and maximize the quality, objectivity, utility, and integrity of its information. FHWA periodically reviews quality issues and adjusts its programs and processes to ensure continuous quality improvement.

Technical Report Documentation Page

1. Report No. FHWA-HRT-04-091		2. Government Accession No.		3. Recipient's Catalog No.	
4. Title and Subtitle Signalized Intersections: Informational Guide				5. Report Date August 2004	
				6. Performing Organization Code	
7. Author(s) Principal Investigator: Lee A. Rodegerdts Co-Investigators: Brandon Nevers, Bruce Robinson Co-Authors: John Ringert, Peter Koonce, Justin Bansen, Tina Nguyen, John McGill, Del Stewart, Jeff Suggett, Tim Neuman, Nick Antonucci, Kelly Hardy, Ken Courage				8. Performing Organization Report No. Project 4770	
9. Performing Organization Name and Address Kittelson & Associates, Inc. 610 SW Alder Street, Suite 700 Portland, OR 97205 Subconsultants: Synectics Transportation Consultants, Inc.; CH2M Hill, Inc.; and Ken Courage				10. Work Unit No. (TRAVIS)	
				11. Contract or Grant No. Contract No. DTFH61-98-C-00075, Task Order No. B98C75-009	
12. Sponsoring Agency Name and Address Federal Highway Administration Turner-Fairbank Highway Research Center 6300 Georgetown Pike, HSR 20, Room No. T301 McLean, VA 22101				13. Type of Report and Period Covered Informational Guide Book October 2001 to June 2004	
				14. Sponsoring Agency Code	
15. Supplementary Notes Joe G. Bared (Joe.Bared@fhwa.dot.gov) at the Turner-Fairbank Highway Research Center (http://www.tfhr.gov) was the Technical Representative for the Federal Highway Administration (FHWA). Project focus group members contributed significantly to document organization, content, and exhibits: Tom Hicks, Maryland State Highway Administration; Nick Kalivoda, Louisiana Department of Transportation; Nazir Lalani, Ventura County (California); John Mason, Pennsylvania State University; and Brian Walsh, Washington State Department of Transportation. In addition, many FHWA staff members participated as focus group members and/or provided comments throughout the project, including Carl Andersen, David Gibson, Hari Kalla, Ray Krammes, Barbara McMillen, Bill Prosser, Fred Ranck, Tamara Redmon, Essie Wagner, and Scott Wainwright.					
16. Abstract This guide provides a single, comprehensive document with methods for evaluating the safety and operations of signalized intersections and tools to remedy deficiencies. The treatments in this guide range from low-cost measures such as improvements to signal timing and signage, to high-cost measures such as intersection reconstruction or grade separation. Topics covered include fundamental principles of user needs, geometric design, and traffic design and operation; safety and operational analysis techniques; and a wide variety of treatments to address existing or projected problems, including individual movements and approaches, pedestrian and bicycle treatments, and corridor techniques. It also covers alternative intersection forms that improve intersection performance through the use of indirect left turns and other treatments. Each treatment includes a discussion of safety, operational performance, multimodal issues, and physical and economic factors that the practitioner should consider. Although the guide focuses primarily on high-volume signalized intersections, many treatments are applicable for lower volume intersections as well. The information contained in this guide is based on the latest research available on treatments and best practices in use by jurisdictions across the United States. Additional resources and references are highlighted for the student, practitioner, researcher, or decisionmaker who wishes to learn more about a particular subject.					
17. Key Words Signalized Intersections, Intersection Safety, Intersection Design, Intersection Performance, Intersection Treatments				18. Distribution Statement	
19. Security Classif. (of this report) Unclassified		20. Security Classif. (of this page) Unclassified		21. No. of Pages 369	22. Price

SI* (MODERN METRIC) CONVERSION FACTORS

APPROXIMATE CONVERSIONS TO SI UNITS

Symbol	When You Know	Multiply By	To Find	Symbol
LENGTH				
in	inches	25.4	millimeters	mm
ft	feet	0.305	meters	m
yd	yards	0.914	meters	m
mi	miles	1.61	kilometers	km
AREA				
in ²	square inches	645.2	square millimeters	mm ²
ft ²	square feet	0.093	square meters	m ²
yd ²	square yard	0.836	square meters	m ²
ac	acres	0.405	hectares	ha
mi ²	square miles	2.59	square kilometers	km ²
VOLUME				
fl oz	fluid ounces	29.57	milliliters	mL
gal	gallons	3.785	liters	L
ft ³	cubic feet	0.028	cubic meters	m ³
yd ³	cubic yards	0.765	cubic meters	m ³
NOTE: volumes greater than 1000 L shall be shown in m ³				
MASS				
oz	ounces	28.35	grams	g
lb	pounds	0.454	kilograms	kg
T	short tons (2000 lb)	0.907	megagrams (or "metric ton")	Mg (or "t")
TEMPERATURE (exact degrees)				
°F	Fahrenheit	5 (F-32)/9 or (F-32)/1.8	Celsius	°C
ILLUMINATION				
fc	foot-candles	10.76	lux	lx
fl	foot-Lamberts	3.426	candela/m ²	cd/m ²
FORCE and PRESSURE or STRESS				
lbf	poundforce	4.45	newtons	N
lbf/in ²	poundforce per square inch	6.89	kilopascals	kPa

APPROXIMATE CONVERSIONS FROM SI UNITS

Symbol	When You Know	Multiply By	To Find	Symbol
LENGTH				
mm	millimeters	0.039	inches	in
m	meters	3.28	feet	ft
m	meters	1.09	yards	yd
km	kilometers	0.621	miles	mi
AREA				
mm ²	square millimeters	0.0016	square inches	in ²
m ²	square meters	10.764	square feet	ft ²
m ²	square meters	1.195	square yards	yd ²
ha	hectares	2.47	acres	ac
km ²	square kilometers	0.386	square miles	mi ²
VOLUME				
mL	milliliters	0.034	fluid ounces	fl oz
L	liters	0.264	gallons	gal
m ³	cubic meters	35.314	cubic feet	ft ³
m ³	cubic meters	1.307	cubic yards	yd ³
MASS				
g	grams	0.035	ounces	oz
kg	kilograms	2.202	pounds	lb
Mg (or "t")	megagrams (or "metric ton")	1.103	short tons (2000 lb)	T
TEMPERATURE (exact degrees)				
°C	Celsius	1.8C+32	Fahrenheit	°F
ILLUMINATION				
lx	lux	0.0929	foot-candles	fc
cd/m ²	candela/m ²	0.2919	foot-Lamberts	fl
FORCE and PRESSURE or STRESS				
N	newtons	0.225	poundforce	lbf
kPa	kilopascals	0.145	poundforce per square inch	lbf/in ²

*SI is the symbol for the International System of Units. Appropriate rounding should be made to comply with Section 4 of ASTM E380.
(Revised March 2003)

TABLE OF CONTENTS

1.0	INTRODUCTION.....	3
1.1	Background	3
1.2	Scope of Guide.....	4
1.3	Audience for this Guide	5
1.4	Organization of the Guidelines	5
PART I FUNDAMENTALS		9
2.0	ROAD USER NEEDS.....	13
2.1	Overview of Human Factors	13
2.1.1	Positive Guidance.....	14
2.1.2	Roadway Safety	15
2.2	Intersection Users.....	16
2.2.1	Human Factors Common to All Road Users	16
2.2.2	Motorists	20
2.2.3	Bicyclists.....	23
2.2.4	Pedestrians.....	27
2.3	Applying Human Factors	32
3.0	GEOMETRIC DESIGN.....	37
3.1	Channelization.....	37
3.2	Number of Intersection Legs	44
3.3	Intersection Angle.....	45
3.4	Horizontal and Vertical Alignment	46
3.5	Corner Radius and Curb Ramp Design	46
3.5.1	Corner Radius	47
3.5.2	Curb Ramp Design	47
3.5.3	Detectable Warnings	51
3.6	Sight Distance	53
3.6.1	Stopping Sight Distance	53
3.6.2	Decision Sight Distance	53
3.6.3	Intersection Sight Distance.....	54
3.7	Pedestrian Facilities	54
3.8	Bicycle Facilities	55
4.0	TRAFFIC DESIGN AND ILLUMINATION	59
4.1	Traffic Signal Control Type.....	59
4.2	Traffic Signal Phasing.....	59
4.2.1	“Permissive-Only” Left-Turn Phasing	60
4.2.2	“Protected-Only” Left-Turn Phasing	62
4.2.3	Protected-Permissive Left-Turn Phasing	63
4.2.4	Split Phasing.....	67
4.2.5	Prohibited Left-Turn Phasing.....	70
4.2.6	Right-Turn Phasing.....	70
4.3	Vehicle and Pedestrian Displays.....	72
4.3.1	Vehicle Displays	72
4.3.2	Pedestrian Displays.....	76
4.4	Traffic Signal Pole Layout.....	77
4.5	Traffic Signal Controller.....	78
4.6	Detection Devices.....	79
4.6.1	Vehicle Detection.....	79
4.6.2	Pedestrian Detection	83

4.7	Basic Signal Timing Parameters	83
4.7.1	Pedestrian Timing.....	84
4.7.2	Vehicle Timing—Green Interval	84
4.7.3	Vehicle Timing—Detector Timing.....	85
4.7.4	Vehicle Timing—Vehicle Clearance	85
4.7.5	Vehicle Timing—Cycle Length	86
4.8	Signing and Pavement Marking Design	86
4.9	Illumination Design	90
4.9.1	Illuminance	91
4.9.2	Veiling Illuminance.....	92
PART II PROJECT PROCESS AND ANALYSIS METHODS		95
5.0	PROJECT PROCESS	99
5.1	Project Initiation	99
5.2	Identify Stakeholder Interests and Objectives	99
5.2.1	Intersection Users.....	100
5.2.2	Adjacent Property/Business Owners.....	100
5.2.3	Facility Managers	100
5.2.4	Other Decisionmakers.....	100
5.3	Data Collection	101
5.3.1	Office Review	101
5.3.2	Field Investigation.....	101
5.4	Problem Identification	102
5.4.1	Establish Performance Measures and Criteria.....	105
5.4.2	Summarize Operational and Safety Conditions	107
5.4.3	Develop Problem Statement	107
5.5	Identify Problem Cause	108
5.6	Treatment Selection	109
5.6.1	Identify Range of Treatments	109
5.6.2	Evaluate Treatments	110
5.6.3	Assess Potential To Introduce Undesirable Effects	110
5.6.4	Determine Costs and Implementation Issues	110
5.7	In-Service Assessments.....	111
5.7.1	Followup Plan	111
5.7.2	Monitoring Program.....	111
6.0	SAFETY ANALYSIS METHODS.....	115
6.1	Balancing Safety and Mobility	115
6.2	Selection of an Intersection	116
6.2.1	Collision Frequency	119
6.2.2	Collision Rate	119
6.2.3	Combined Collision Frequency and Rate Method	120
6.2.4	Collision Severity Method.....	120
6.2.5	Critical Collision Rate	121
6.2.6	Risk Analysis Methods	121
6.2.7	Safety Performance Functions	122
6.2.8	Empirical Bayes Method.....	122
6.2.9	Conclusions	123
6.3	Identification of Potential Problems	125
6.3.1	Safety Diagnosis.....	125
6.3.2	Assemble Collision Data	126
6.3.3	Analyze/Diagnose Collision Data	128
6.3.4	Determine Overrepresentation	129
6.3.5	Conduct Site Visit(s)	132
6.3.6	Deciding on Further Analysis	134

6.3.7	Conducting Further Studies.....	134
6.3.8	Defining the Problem Statement	135
6.4	Identification of Possible Treatments	136
6.4.1	List Possible Treatments	136
6.4.2	Screen Treatments	138
6.4.3	Selecting a Collision Modification Factor or Study Finding	139
6.4.4	Quantify Safety Benefit.....	140
6.4.5	Selected Treatment(s).....	142
6.5	Improvement Plan Development.....	142
7.0	OPERATIONAL ANALYSIS METHODS.....	145
7.1	Operational Measures of Effectiveness	146
7.1.1	Motor Vehicle Capacity and Volume-to-Capacity Ratio	147
7.1.2	Motor Vehicle Delay and Level of Service	148
7.1.3	Motor Vehicle Queue.....	148
7.1.4	Transit Level of Service.....	149
7.1.5	Bicycle Level of Service.....	149
7.1.6	Pedestrian Level of Service.....	150
7.2	Traffic Operations Elements.....	151
7.2.1	Traffic Volume Characteristics	151
7.2.2	Intersection Geometry	152
7.2.3	Signal Timing.....	152
7.3	Rules of Thumb for Sizing an Intersection	153
7.4	Critical Movement Analysis	154
7.5	HCM Operational Procedure for Signalized Intersections	157
7.6	Arterial and Network Signal Timing Models	157
7.7	Microscopic Simulation Models.....	158
PART III TREATMENTS.....		159
8.0	SYSTEM-WIDE TREATMENTS	163
8.1	Median Treatments.....	163
8.1.1	Description.....	163
8.1.2	Applicability.....	163
8.1.3	Key Design Features	163
8.1.4	Safety Performance.....	169
8.1.5	Operational Performance	169
8.1.6	Multimodal Impacts.....	169
8.1.7	Physical Impacts.....	170
8.1.8	Socioeconomic Impacts	170
8.1.9	Enforcement, Education, and Maintenance	170
8.1.10	Summary	170
8.2	Access Management.....	171
8.2.1	Description.....	171
8.2.2	Applicability.....	172
8.2.3	Design Features	172
8.2.4	Safety Performance.....	177
8.2.5	Operational Performance	177
8.2.6	Multimodal Impacts.....	178
8.2.7	Physical Impacts.....	178
8.2.8	Socioeconomic Impacts	178
8.2.9	Enforcement, Education, and Maintenance	178
8.2.10	Summary	178

8.3	Signal Coordination	179
8.3.1	Description.....	179
8.3.2	Applicability.....	179
8.3.3	Safety Performance.....	180
8.3.4	Operational Performance	180
8.3.5	Multimodal Impacts.....	181
8.3.6	Physical Impacts.....	181
8.3.7	Socioeconomic Impacts	181
8.3.8	Enforcement, Education, and Maintenance	181
8.3.9	Summary	181
8.4	Signal Preemption and/or Priority.....	181
8.4.1	Description.....	181
8.4.2	Emergency Vehicle Preemption	182
8.4.3	Applicability.....	182
8.4.4	Safety Performance.....	183
8.4.5	Operational Performance	183
8.4.6	Multimodal Impacts.....	183
8.4.7	Physical Impacts.....	183
8.4.8	Socioeconomic Impacts	183
8.4.9	Enforcement, Education, and Maintenance	183
8.4.10	Summary	183
9.0	INTERSECTION-WIDE TREATMENTS	187
9.1	Pedestrian Treatments	187
9.1.1	Reduce Curb Radius	187
9.1.2	Provide Curb Extensions.....	190
9.1.3	Modify Stop Bar Location	192
9.1.4	Improve Pedestrian Signal Displays.....	194
9.1.5	Modify Pedestrian Signal Phasing.....	196
9.1.6	Grade-Separate Pedestrian Movements.....	199
9.2	Bicycle Treatments	201
9.2.1	Provide Bicycle Box.....	201
9.2.2	Provide Bike Lanes.....	202
9.3	Transit Treatments	203
9.3.1	Relocate Transit Stop	203
9.4	Traffic Control Treatments.....	205
9.4.1	Change Signal Control from Pre-Timed to Actuated.....	205
9.4.2	Modify Yellow Change Interval and/or Red Clearance Interval	208
9.4.3	Modify Cycle Length	211
9.4.4	Late Night/Early Morning Flash Removal.....	212
9.5	Street Lighting and Illumination	214
9.5.1	Provide or Upgrade Illumination	214
10.0	ALTERNATIVE INTERSECTION TREATMENTS	221
10.1	Intersection Reconfiguration and Realignment Treatments.....	222
10.1.1	Remove Intersection Skew Angle	222
10.1.2	Remove Deflection in Travel Path for Through Vehicles	225
10.1.3	Convert Four-Leg Intersection to Two T-Intersections.....	227
10.1.4	Convert Two T-Intersections to Four-Leg Intersection.....	229
10.1.5	Close Intersection Leg.....	230

10.2	Indirect Left-Turn Treatments.....	232
10.2.1	Jughandle	232
10.2.2	Median U-Turn Crossover	242
10.2.3	Continuous Flow Intersection	249
10.2.4	Quadrant Roadway Intersection.....	256
10.2.5	Super-Street Median Crossover.....	260
10.3	Grade Separation Treatments.....	264
10.3.1	Split Intersection	265
10.3.2	Diamond Interchange	269
11.0	APPROACH TREATMENTS.....	279
11.1	Signal Head Placement and Visibility	279
11.1.1	Convert to Mast Arm or Span Wire Mounted Signal Heads.....	280
11.1.2	Add Near-Side Signal Heads	281
11.1.3	Increase Size of Signal Heads	282
11.1.4	Use Two Red Signal Sections.....	284
11.1.5	Increase Number of Signal Heads	286
11.1.6	Provide Backplates.....	288
11.1.7	Provide Advance Warning.....	290
11.2	Signing and Speed Control Treatments	292
11.2.1	Improve Signing.....	292
11.2.2	Reduce Operating Speed.....	294
11.3	Roadway Surface Improvements	294
11.3.1	Improve Pavement Surface	294
11.3.2	Provide Rumble Strips.....	297
11.3.3	Improve Cross Section	298
11.3.4	Remove Obstacles from Clear Zone	300
11.4	Sight Distance Treatments	301
11.4.1	Improve Sight Lines.....	301
12.0	INDIVIDUAL MOVEMENT TREATMENTS.....	307
12.1	Left-Turn Treatments.....	307
12.1.1	Add Single Left-Turn Lane	307
12.1.2	Multiple Left-Turn Lanes.....	318
12.1.3	Turn Prohibition	322
12.2	Through Lane Treatments.....	324
12.2.1	Provide Auxiliary Through Lanes	324
12.2.2	Delineate Through Path	326
12.3	Right-Turn Treatments	328
12.3.1	Add Single Right-Turn Lane	328
12.3.2	Provide Double Right-Turn Lanes.....	333
12.3.3	Provide Channelized Right-Turn Lane	334
12.4	Variable Lane Use Treatments.....	336
12.4.1	Provide Reversible Lanes	336
12.4.2	Provide Variable Lane Use Assignments.....	338
	REFERENCES.....	341
	BIBLIOGRAPHY (OTHER REFERENCES)	353

LIST OF FIGURES

<u>Figure</u>	<u>Page</u>
CHAPTER 2	
1 Traffic controls such as official signs need to be close to the road, distinctive from other information presentations, brief, and explicit. This photo provides an example of signs that are close to the road but may be confused with background information....	17
2 In terms of both official signs and advertising displays, too many displays may have the effect of causing drivers to “tune out,” and recall will be poor. This photo shows an example of sign clutter where the regulatory sign is difficult to isolate from the background advertising signs	17
3 Enforcement cameras, as shown in the photo above, are used at signalized intersections to identify red light runners.....	23
4 Typical dimensions of a bicyclist.....	25
5 Bicyclist conflicts at signalized intersections.....	27
6 Examples of pedestrians of various abilities preparing to cross an intersection	28
7 Typical dimensions for a turning wheelchair	29
8 Crosswalks are used by a variety of users with different speed characteristics. Pedestrian walking speeds generally range between 0.8 to 1.8 m/s (2.5 to 6.0 ft/s)	30
9 Pedestrian conflicts at signalized intersections.....	31
CHAPTER 3	
10 The photograph shows a raised median that restricts left-turn egress movements from a driveway located between two signalized intersections	38
11 Pavement markings can be used to delineate travel lanes within wide intersections as shown in the photograph.....	39
12 Various right-turn treatments may be used, depending on the speed environment.....	40
13 Providing a dedicated left-turn lane reduces potential collisions between left-turning and through vehicles, increasing the capacity of the approach for both left and through traffic	41
14 The photo shows how double left-turn and double right-turn lanes can be used to accommodate high-priority movements.....	42
15 Intersection skew increases both the intersection width and pedestrian crossing distance	43
16 The photograph illustrates a multileg intersection.....	44
17 Potential conflicts at intersections with three and four legs	45
18 Curb ramp components.....	48
19 Examples of preferred designs	50
20 Examples of acceptable curb ramp designs	50
21 Examples of inaccessible designs	50
22 This crosswalk design incorporates the use of detectable warning surfaces into the curb ramps to facilitate navigation by a visually impaired pedestrian.....	51
CHAPTER 4	
23 Standard NEMA ring-and-barrier structure	60
24 Typical phasing diagram for “permissive-only” left-turn phasing	61
25 Possible signal head arrangements for “permissive-only” left-turn phasing	62
26 Typical phasing diagram for “protected-only” left-turn phasing.....	63
27 Possible signal head arrangements for “protected-only” left-turn phasing	63
28 Typical phasing diagram for protected-permissive left-turn phasing	64
29 Possible signal head and signing arrangement for protected-permissive left-turn phasing	64
30 Illustration of the yellow trap.....	66
31 The protected-permissive left-turn display known as “Dallas display” uses louvers to restrict visibility of the left-turn display to adjacent lanes	67

<u>Figure</u>	<u>Page</u>
CHAPTER 4, CONTINUED	
32 Typical phasing diagrams for split phasing	69
33 Common signal head arrangement for split phasing	70
34 Typical phasing diagram illustrating a right-turn overlap	71
35 Common signal head and signing arrangement for right-turn-overlap phasing	72
36 Examples showing five optional signal head locations	74
37 Pedestrian signal indicators	76
38 Example of advance street name sign for upcoming intersection	87
39 Example of advance street name sign for two closely spaced intersections	88
40 Example of signing for a left-hand land trap	88
41 Example of advance overhead signs indicating lane use for various destinations.....	89
42 Example of pavement legends indicating destination route numbers ("horizontal signage")	90
CHAPTER 6	
43 Exclusion of property-damage-only collisions (such as this one from an analysis) may mask valuable information	117
44 The potential for error in coding the location of a collision should be understood.....	118
45 Selecting a candidate intersection using a combined collision frequency/collision rate method, where each diamond represents an intersection.....	120
46 Example of SPF curve.....	122
47 Identification of potential problems.....	126
48 The original police collision report may contain valuable information regarding collisions that have occurred at the intersection.....	127
49 Possible taxonomy for collision type classification.....	131
50 Conducting a site visit	133
51 Examples of problem statements.....	135
52 Identification of possible treatments.....	136
CHAPTER 7	
53 Still reproduction of a graphic from an animated traffic operations model.....	146
54 Overview of intersection traffic analysis models	147
55 Pedestrian LOS based on cycle length and minimum effective pedestrian green time	151
56 Graphical summary of the Quick Estimation Method.....	155
CHAPTER 8	
57 Issues associated with intersections with a narrow median	164
58 Issues associated with intersections with a wide median	165
59 Median pedestrian treatments.....	167
60 Median pedestrian signal treatments	168
61 This refuge island enables two-stage pedestrian crossings	169
62 Comparison of physical and functional areas of an intersection.....	172
63 Diagram of the upstream functional area of an intersection	173
64 Access points near signalized intersections	175
65 Access management requiring U-turns at a downstream signalized intersection	176
66 Access management requiring U-turns at an unsignalized, directional median opening..	176
CHAPTER 9	
67 A curb radius from 4.6 m (15 ft) to 15.2 m (50 ft) increases the pedestrian crossing distance from 18.9 m (62 ft) to 30.5 m (100 ft), all else being equal	188
68 Intersection with curb extension.....	191
69 Examples of countdown and animated eyes pedestrian signal displays.....	195
70 A pedestrian grade separation treatment.....	200
71 Typical lighting layouts	215

<u>Figure</u>	<u>Page</u>
CHAPTER 10	
72	Illustration of conflict points for a four-leg signalized intersection..... 222
73	Diagrams of different types of intersection realignment..... 223
74	Example of deflection in travel paths for through vehicles..... 226
75	Conflict point diagram for two closely spaced T-intersections 228
76	Diagram of a jughandle intersection..... 233
77	Vehicular movements at a jughandle intersection 233
78	Example of a jughandle intersection 234
79	Another example of a jughandle intersection 234
80	Design layout of near-side jughandle..... 236
81	Design layout of far-side jughandle 237
82	Example of jughandle and associated signing..... 238
83	Signal phasing of a jughandle intersection 239
84	Conflict point diagram for a four-leg signalized intersection with two jughandles 240
85	Diagram of a median U-turn crossover from the main line 242
86	Vehicular movements at a median U-turn intersection 243
87	Example of median U-turn signing in Michigan..... 244
88	Diagram of general placement of a median U-turn crossover 245
89	Diagram of a median U-turn crossover from the main line with a narrow median..... 245
90	Conflict diagram for a four-leg signalized intersection with median U-turns..... 247
91	Diagram of a continuous flow intersection 250
92	Vehicular movements at a continuous flow intersection 250
93	Continuous flow intersection 251
94	Displaced left turn at a continuous flow intersection 251
95	Signal phasing of a continuous flow intersection 252
96	Conflict diagram for a continuous flow intersection with displaced left turns on the major street only..... 253
97	Diagram of a quadrant roadway intersection 257
98	Vehicular movements at a quadrant roadway intersection 257
99	Signal phasing of a quadrant roadway intersection 258
100	Conflict point diagram for four-leg signalized intersection with quadrant roadway..... 259
101	Illustration of super-street median crossover 261
102	Vehicular movements at a super-street median crossover..... 261
103	Signal phasing of a super-street median crossover..... 262
104	Conflict diagram for a super-street median crossover..... 263
105	Illustration of a split intersection 266
106	Conflict point diagram for a split intersection 267
107	Diagram of a single-point interchange 270
108	Diagram of a compressed diamond interchange 271
109	Typical signal phasing of a single-point interchange 271
110	Typical signal phasing of a compressed diamond interchange 272
111	Single-point diamond interchange conflict point diagram 273
112	Compressed diamond interchange conflict point diagram..... 274
CHAPTER 11	
113	Signal head with a double red signal indication 285
114	Lane-aligned signal heads 287
115	Illustration of sight distance triangles 302

<u>Figure</u>	<u>Page</u>
CHAPTER 12	
116 Diagram of a single left-turn lane	308
117 Narrow (2.4-m (8-ft) left-turn lanes may be used effectively in retrofit situations	311
118 Example of positive offset	312
119 Intersection with turn paths delineated for dual left-turn lanes in Tucson, AZ (Kolb Road/ 22nd Street), June 1998	321
120 Diagram of an auxiliary through lane	324
121 Example of delineated paths.....	327
122 Diagram of a typical right-turn lane	328
123 Narrow (2.4-m (8-ft) right-turn lanes may be used effectively in retrofit situations	330
124 Example illustration of a channelized right-turn lane	334
125 Example use of variable lane use sign to add a third left-turn lane during certain times of day.....	339
126 Example use of variable lane use sign to add a second right-turn lane along a corridor during certain times of day.....	339

LIST OF TABLES

<u>Table</u>	<u>Page</u>
CHAPTER 1	
1 Summary of motor vehicle crashes related to junction and severity in the United States during 2002	3
2 Organization of the guide	6
3 List of intersection treatments discussed in this document.....	7
CHAPTER 2	
4 Estimated number of registered vehicles by type, 2002	20
5 Fatalities and injuries by mode, 2001.....	21
6 Total motor vehicle crashes and injury/fatal collisions at signalized intersections by total ADT entering the intersection	21
7 Proportion of crashes by collision type at signalized intersections	22
8 Typical dimensions for a sample of types of pedestrians	29
CHAPTER 3	
9 Summary of best practices for curb ramp design and associated rationale	49
10 Requirements for detectable warning surfaces.....	52
11 Design values for stopping sight distance.....	53
12 Design values for decision sight distance for selected avoidance maneuvers.....	54
CHAPTER 4	
13 Advantages and disadvantages of various configurations for displaying vehicle signal indications	77
14 Traffic signal controller advantages and disadvantages.....	79
15 Strengths and weaknesses of commercially available detector technologies.....	81
16 Location of advanced vehicle detectors	83
17 Recommended illuminance for the intersection of continuously lighted urban streets.....	92
18 RP-8-00 guidance for roadway and pedestrian/area classification for purposes of determining intersection illumination levels	93
CHAPTER 5	
19 Example stakeholder interests and objectives.....	101
20 User characteristics.....	103
21 Operational characteristics.....	103
22 Safety characteristics	104
23 Geometric, traffic signal control, and land use characteristics.....	104
24 Policy and background information	105
25 Common concerns raised by stakeholders.....	105
26 Example performance measures and criteria	106
27 Possible causes of intersection problems.....	109
CHAPTER 6	
28 Suggested weighting for collision severity method	121
29 Common methods of assessing safety at a location.....	124
30 Chi-square test values and corresponding confidence levels	129
31 Collision types commonly identified, possible causes, and associated treatments.....	138
32 Example calculation of safety benefit of adding a right-turn lane	141

<u>Table</u>	<u>Page</u>
CHAPTER 7	
33 Motor vehicle LOS thresholds at signalized intersections	148
34 Bicycle LOS thresholds at signalized intersections	150
35 Pedestrian LOS thresholds at signalized intersections.....	150
36 Planning-level guidelines for sizing an intersection	153
37 V/C ratio threshold descriptions for the Quick Estimation Method.....	156
CHAPTER 8	
38 Summary of issues for providing median treatments.....	171
39 Relative crash rates for unsignalized intersection access spacing.....	177
40 Summary of issues for providing access management	179
41 Selected findings of safety benefits associated with signal coordination or progression ..	180
42 Summary of issues for providing signal coordination	181
43 Summary of issues for providing signal preemption and/or priority	184
CHAPTER 9	
44 Summary of issues for curb radius reduction.....	190
45 Summary of issues for curb extensions	192
46 Summary of issues for stop bar alterations.....	194
47 Safety benefits associated with addition of pedestrian signals: Selected findings	195
48 Summary of issues for pedestrian signal display improvements	196
49 Summary of issues for pedestrian signal phasing modifications	199
50 Summary of issues for pedestrian grade separation	201
51 Summary of issues for providing a bicycle box.....	202
52 Summary of issues for providing bicycle lanes	203
53 Summary of issues for near-side/far-side transit stops.....	205
54 Safety benefits associated with upgrading an intersection from pre-timed to actuated operation: Selected findings.....	207
55 Summary of issues for providing signal actuation.....	208
56 Safety benefits associated with modifying clearance intervals: Selected findings	210
57 Summary of issues for modifying yellow/red clearance intervals	211
58 Summary of issues for cycle length modifications	212
59 Safety benefits associated with removal of signal from late night/early morning flash mode: Selected findings.....	213
60 Summary of issues for flash mode removal	214
61 Safety benefits associated with providing illumination: Selected findings	216
62 Summary of issues for providing illumination.....	217
CHAPTER 10	
63 Summary of issues for removing intersection skew.....	225
64 Summary of issues for removing deflection of vehicle path.....	227
65 Number of conflict points at a four-leg signalized intersection compared to two closely spaced T-intersections.....	227
66 Safety benefits of converting a four-leg signalized intersection to two T-intersections: Expert opinion	228
67 Summary of issues for converting a four-leg intersection to two T-intersections	229
68 Summary of issues for converting two T-intersections to one four-leg intersection	230
69 Safety benefits associated with street closures: Selected findings.....	231
70 Summary of issues for closing an intersection approach leg.....	232
71 Number of conflict points at a four-leg signalized intersection compared to a four-leg signalized intersection with a jughandle	240
72 Safety benefits of converting a four-leg signalized intersection to a four-leg signalized intersection with two jughandles: Expert opinion	240
73 Summary of issues for jughandles	242

<u>Table</u>	<u>Page</u>
CHAPTER 10, CONTINUED	
74	Number of conflict points at a four-leg signalized intersection compared to a four-leg signalized intersection with a median U-turn crossover configuration..... 246
75	Safety benefits of converting a four-leg signalized intersection to median U-turn crossover configuration: Expert opinion..... 247
76	Summary of issues for median U-turn crossovers 249
77	Number of conflict points at a four-leg signalized intersection compared to a continuous flow intersection with displaced left turns on the major street only..... 253
78	Safety benefits of converting a four-leg signalized intersection to a CFI: Expert opinion.. 254
79	Summary of issues for continuous flow intersections 256
80	Number of conflict points at a four-leg signalized intersection compared to a four-leg signalized intersection with a quadrant roadway 258
81	Safety benefits of adding a quadrant roadway to a four-leg signalized intersection: Expert opinion 259
82	Summary of issues for quadrant roadways..... 260
83	Number of conflict points at a four-leg signalized intersection compared to a super-street median crossover..... 263
84	Safety benefits of converting a four-leg signalized intersection compared to a super-street median crossover: Expert opinion 263
85	Summary of issues for super-street median crossovers..... 264
86	Number of conflict points at a four-leg signalized intersection compared to a split intersection..... 267
87	Safety benefits of converting a four-leg signalized intersection to a split intersection: Expert opinion 268
88	Summary of issues for split intersections..... 269
89	Number of conflict points at a four-leg signalized intersection compared to a compressed diamond and single-point diamond interchange 273
90	Safety benefits of converting a four-leg signalized intersection to a compressed diamond and single-point diamond interchange: Expert opinion..... 275
91	Summary of issues for single-point and compressed diamond interchanges 276
CHAPTER 11	
92	Summary of approach treatments..... 279
93	Safety benefits associated with using mast arms: Selected findings..... 280
94	Summary of issues for using mast arm/span wire mounted signal heads..... 281
95	Summary of issues for supplemental near-side traffic signal heads 282
96	Safety benefits associated with using 300-mm (12-inch) signal lenses: Selected findings..... 283
97	Summary of issues for increasing the size of signal heads 284
98	Safety benefits associated with using a double red indication (red "T") display: Selected findings..... 285
99	Summary of issues for using two red signal sections 286
100	Safety benefits associated with addition of a signal head: Selected findings..... 288
101	Summary of issues for adding a signal head 288
102	Safety benefits associated with the use of signal backplates: Selected findings 289
103	Summary of issues for using signal head backplates 290
104	Safety benefits associated with advance warning signs and flashers: Selected findings . 291
105	Summary of issues related to advance warning treatments 292
106	Safety benefits associated with sign treatments: Selected findings 293
107	Summary of issues for improving signing 294
108	Safety benefits associated with nonskid treatments, drainage improvements, or resurfacing: Selected findings..... 296
109	Summary of issues for pavement treatments 297
110	Safety benefits associated with rumble strips: Selected findings 297

<u>Table</u>	<u>Page</u>
CHAPTER 11, CONTINUED	
111 Summary of issues for rumble strips.....	298
112 Summary of issues for cross section improvements	300
113 Summary of issues for removing obstacles from the clear zone	301
114 Expected reduction in number of crashes per intersection per year by increased sight distance	303
115 Safety benefits associated with sight distance improvements: Selected findings	303
116 Summary of issues for visibility improvements	304
CHAPTER 12	
117 Rule-of-thumb intersection capacities assuming various exclusive left-turn treatments ...	309
118 Guidelines for use of left-turn phasing	313
119 Guidelines for selection of type of left-turn phasing	314
120 Minimum recommended sight distance for allowing permissive left turns.....	315
121 Safety benefits associated with left-turn lane design improvements: Selected findings ...	316
122 Summary of issues for left-turn lanes.....	317
123 Safety benefits associated with multiple left-turn lanes: Selected findings.....	319
124 Summary of issues for multiple left-turn lanes	322
125 Safety benefits associated with left-turn operational treatments: Selected findings.....	323
126 Summary of issues for turn prohibitions.....	324
127 Summary of issues for auxiliary through lanes	326
128 Summary of issues for path delineation	327
129 Right-turn lane volume warrants	329
130 Safety benefits associated with right-turn improvements: Selected findings.....	331
131 Summary of issues for right-turn lanes	332
132 Summary of issues for double right-turn lanes	334
133 Safety benefits associated with right-turn channelization: Selected findings	335
134 Summary of issues for channelized right-turn lanes	336
135 Summary of issues for reversible lanes	338
136 Summary of issues for variable lane use	340

CHAPTER 1

INTRODUCTION

TABLE OF CONTENTS

1.0	INTRODUCTION	3
1.1	Background	3
1.2	Scope of Guide	4
1.3	Audience for this Guide.....	5
1.4	Organization of the Guidelines.....	5

LIST OF TABLES

<u>Table</u>		<u>Page</u>
1	Summary of motor vehicle crashes related to junction and severity in the United States during 2002.....	3
2	Organization of the guide.....	6
3	List of intersection treatments discussed in this document	7

1.0 INTRODUCTION

This guide provides a single, comprehensive document with methods for evaluating the safety and operations of signalized intersections and tools to remedy deficiencies. The treatments in this guide range from low-cost measures such as improvements to signal timing and signage, to high-cost measures such as intersection reconstruction or grade separation. While some treatments apply only to higher volume intersections, much of this guide is applicable to signalized intersections of all volume levels.

The guide takes a holistic approach to signalized intersections and considers the safety and operational implications of a particular treatment on all system users (motorists, pedestrians, bicyclists, transit users).

Practitioners will find the tools and information necessary to make insightful intersection assessments and to understand the tradeoffs of potential improvement measures. The information here is based on the latest research available and includes examples of novel treatments as well as best practices in use by jurisdictions across the United States. Additional resources and references are highlighted for the practitioner who wishes to learn more about a particular subject.

This guide is not intended to replicate or replace traditional traffic engineering documents such as the *Manual on Uniform Traffic Control Devices (MUTCD)*,⁽¹⁾ the *Highway Capacity Manual (HCM) 2000*,⁽²⁾ or the American Association of State Highway and Transportation Officials' (AASHTO) *A Policy on Geometric Design of Highways and Streets*,⁽³⁾ nor is it intended to serve as a standard or policy document. Rather, it provides a synthesis of the best practices and novel treatments intended to help practitioners make informed, thoughtful decisions.

1.1 BACKGROUND

Traffic signals are a common form of traffic control used by State and local agencies to address roadway operations. They allow the shared use of road space by separating conflicting movements in time and allocating delay. They can also be used to enhance the mobility of some movements as, for example, along a major arterial.

Traffic signals play a prominent role in achieving safer performance at intersections. Research has shown that, under the right circumstances, the installation of traffic signals will reduce the number and severity of crashes. But inappropriately designed and/or located signals can have an adverse effect on traffic safety, so care in their placement, design, and operation is essential. Table 1 shows that in 2002, 21 percent of all crashes and 24 percent of all fatalities and injury collisions occurred at signalized intersections.

Table 1. Summary of motor vehicle crashes related to junction and severity in the United States during 2002.

	Total Crashes		Fatalities/Injuries	
	Number	Percent	Number	Percent
Non-Intersection Crashes	3,599,000	57	1,022,549	52
Signalized Intersection Crashes	1,299,000	21	462,766	24
Non-Signalized Intersection Crashes	1,418,000	22	481,994	25
Total	6,316,000	100	1,967,309	100

Source: Adapted from table 28 of *Traffic Safety Facts 2002*.⁽⁴⁾

In some cases, the dual objectives of mobility and safety conflict. To meet increasing and changing demands, one element may need to be sacrificed to some degree to achieve improvements in another. In all cases, it is important to understand the degree to which traffic signals are providing mobility and safety for each of transportation.

Assuring the efficient operation of the traffic signal is becoming an increasingly important issue as agencies attempt to maximize vehicle roadway capacity to serve the growing demand for travel. "Quick fixes" and low-cost treatments are increasingly limited.

Grade separation has traditionally been viewed as the next logical step beyond a signalized intersection. In some cases, grade separation may be the most appropriate choice, and the practitioner needs guidance on when and how to make the transition to an interchange. However, given the construction costs, availability of right-of-way, and social and environmental constraints associated with a grade-separated improvement, alternative traffic control and geometric design forms are sometimes preferable if they can be shown to be feasible and adequate from operational, safety, and design perspectives.

A variety of alternative traffic control forms can be found around the country, many of which have seen widespread application in only limited geographic areas. For example, New Jersey has long had a practice of using jughandle left turns to improve the operation of signalized intersections. Michigan has used median U-turns to eliminate movements at critical intersections. Maryland and New York have constructed versions of a continuous flow intersection.

Reducing crashes should always be one of the objectives whenever the design or operational characteristics of a signalized intersection are modified. As described by the Federal Highway Administration (FHWA), the "mission is not simply to improve mobility and productivity, but to ensure that improved mobility and productivity come with improved safety."⁽⁵⁾

1.2 SCOPE OF GUIDE

This guide covers all aspects of signalized intersections, with some emphasis on signalized intersections with traffic volumes typically exceeding 40,000 entering vehicles per day where all approaches are heavily used. These are intersections well beyond MUTCD volume thresholds for signal warrants. This is intended to cover arterial/arterial level facilities and higher. Intersections of this size typically include a minimum of five lanes on the major street and three lanes on the minor street. Intersections considered for grade separation are within the scope of the guide.

The intersection forms considered here include signalized at-grade intersections and intersections with the potential for grade separation. Intersections that include alternative or unconventional turn treatments such as median U-turns and jughandles are within the scope of these guidelines to the extent that they have been implemented and accepted by some U.S. jurisdictions. Roundabouts are not addressed in this document; for more information, please refer to FHWA's *Roundabouts: An Informational Guide*.⁽⁶⁾

The guide addresses safety and operation for all users of signalized intersections including motorists, pedestrians, bicyclists, and transit riders. This guide addresses Americans with Disabilities Act (ADA) requirements and provides guidelines for considering older drivers.

1.3 AUDIENCE FOR THIS GUIDE

This guide is intended for planners, designers, and operations analysts who perform, or want to perform, one or more of the following functions as they pertain to signalized intersections:

- Evaluate substantive safety performance experienced by users of the system.
- Evaluate operational performance experienced by users of the system.
- Identify treatments that could address a particular operational or safety deficiency.
- Understand fundamental user needs, geometric design elements, or signal timing and traffic design elements.
- Understand the impacts and tradeoffs of a particular intersection treatment.

It is envisioned that this guide will be used by engineers, planners, and decisionmakers who:

- Are involved with the planning, design, and operation of signalized intersections, particularly those with high volumes.
- Are involved with the identification of potential treatments.
- Make decisions regarding the implementation of treatments at those intersections.

1.4 ORGANIZATION OF THE GUIDELINES

This guide is arranged in three parts:

- Part I: Fundamentals.
- Part II: Project Process and Analysis Methods.
- Part III: Treatments.

The chapters on fundamentals (chapters 2-4) in part I provide key background information on three topic areas: user needs, geometric design, and traffic design and illumination. These chapters provide a foundation of knowledge of signalized intersections that is useful as a learning tool for entry-level engineers and as a refresher for more experienced engineers. The information contained in these chapters is referenced in parts II and III.

The chapters on project process and analysis methods (chapters 5-7) in part II outline the steps that should be carried out in a project involving the evaluation and assessment of a signalized intersection. Part II also provides tools practitioners can use to evaluate the safety and operational performance of an intersection and determine geometric needs.

Part III provides a description of treatments that can be applied to mitigate a known safety or operational deficiency. The treatments are organized in chapters 8-12 based on the intersection element (system, approach, movement, etc.). Within each chapter, the treatments are grouped by a particular user type (e.g., pedestrian treatments) or are grouped to reflect a particular condition (e.g., signal head visibility).

Table 2 depicts the organization of the guide.

Table 2. Organization of the guide.

Part	Chapter	Title
	1	Introduction
Part I: Fundamentals	2	User Needs
	3	Geometric Design
	4	Traffic Design and Illumination
Part II: Project Process and Analysis Methods	5	Project Process
	6	Safety Analysis Methods
	7	Operational Analysis Methods
Part III: Treatments	8	System-Wide Treatments <ul style="list-style-type: none"> • Access Management • Signal Coordination
	9	Intersection-Wide Treatments <ul style="list-style-type: none"> • Pedestrian Facilities and Design • Bicycle Facilities and Design • Transit Facilities and Design • Traffic Control • Illumination
	10	Alternative Intersection Treatments <ul style="list-style-type: none"> • Indirect Left-Turn Movements • Intersection Reconfiguration • Grade Separation
	11	Approach Treatments <ul style="list-style-type: none"> • Signal Head Placement and Visibility • Signing and Speed Control • Pavement/Cross Section • Sight Distance
	12	Individual Movement Treatments <ul style="list-style-type: none"> • Left-Turn Movements • Through Movements • Right-Turn Movements • Variable Lane Use

Table 3 provides a list of the treatments discussed in part III. Each treatment includes a description, a photo or diagram where available, and a summary of the treatment’s applicability. In addition, these sections identify key design elements; operational and safety impacts; impacts on other modes; socioeconomic and physical impacts; and education, enforcement, and maintenance issues. The treatments in table 3 represent some, but not all, possible treatments.

Table 3. List of intersection treatments discussed in this document.

Treatment Type		Treatments
System-Wide Treatments (Chapter 8)	<ul style="list-style-type: none"> • Provide median • Access management 	<ul style="list-style-type: none"> • Provide signal coordination • Provide signal preemption/priority
Intersection-Wide Treatments (Chapter 9)	<ul style="list-style-type: none"> • Reduce curb radius • Provide curb extensions • Provide advance stop bars • Improve pedestrian signal display • Modify pedestrian signal phasing • Separate pedestrian movements 	<ul style="list-style-type: none"> • Provide bicycle box • Provide bike lanes • Relocate transit stop • Convert from pre-timed to actuated operation • Modify clearance interval • Modify cycle length • Remove late night/early morning flash • Provide/upgrade illumination
Alternative Intersection Treatments (Chapter 10)	<ul style="list-style-type: none"> • Jughandle • Median U-turn • Continuous-flow intersection • Remove skew • Remove deflection in through path • Improve horizontal/vertical alignment 	<ul style="list-style-type: none"> • Split intersection • Quadrant roadway intersection • Super-street median crossover • Convert four-leg intersection to two T intersections • Convert two T intersections to four-leg intersection • Close intersection leg • Convert to diamond interchange
Approach Treatments (Chapter 11)	<ul style="list-style-type: none"> • Convert to mast arm or span wire • Add near-side pole-mounted signal heads • Increase size of signal heads • Use two red signal sections • Increase number of signal heads 	<ul style="list-style-type: none"> • Provide backplates • Improve signing • Provide advance warning • Reduce operating speed • Improve pavement surface • Provide rumble strips • Improve cross section • Remove obstacles from clear zone • Improve sight lines
Individual Movement Treatments (Chapter 12)	<ul style="list-style-type: none"> • Add single left-turn lane • Add multiple left-turn lane • Prohibit turn movements • Provide auxiliary through lane • Add single right-turn lane 	<ul style="list-style-type: none"> • Provide double right-turn lanes • Provide channelized right-turn lane • Delineate path • Provide reversible lane • Provide variable lane use

Part I

Fundamentals

Part I discusses the fundamentals of signalized intersections as they relate to User Needs (chapter 2), Geometric Design (chapter 3), and Traffic Design and Illumination (chapter 4). These chapters are intended for use by entry-level engineers and other users of the guide who seek broad-level information on the technical aspects of signalized intersections. The information provides a background for the chapters in part II and part III.

CHAPTER 2

ROAD USER NEEDS

TABLE OF CONTENTS

2.0	ROAD USER NEEDS	13
2.1	Overview of Human Factors	13
2.1.1	Positive Guidance	14
2.1.2	Roadway Safety	15
2.2	Intersection Users	16
2.2.1	Human Factors Common to All Road Users.....	16
2.2.2	Motorists.....	20
2.2.3	Bicyclists	23
2.2.4	Pedestrians	27
2.3	Applying Human Factors.....	32

LIST OF FIGURES

<u>Figure</u>		<u>Page</u>
1	Traffic controls such as official signs need to be close to the road, distinctive from other information presentations, brief, and explicit. This photo provides an example of signs that are close to the road but may be confused with background information	17
2	In terms of both official signs and advertising displays, too many displays may have the effect of causing drivers to “tune out,” and recall will be poor. This photo shows an example of sign clutter where the regulatory sign is difficult to isolate from the background advertising signs	17
3	Enforcement cameras, as shown in the photo above, are used at signalized intersections to identify red light runners	23
4	Typical dimensions of a bicyclist.....	25
5	Bicyclist conflicts at signalized intersections	27
6	Examples of pedestrians of various abilities preparing to cross an intersection	28
7	Typical dimensions for a turning wheelchair.....	29
8	Crosswalks are used by a variety of users with different speed characteristics. Pedestrian walking speeds generally range between 0.8 to 1.8 m/s (2.5 to 6.0 ft/s).....	30
9	Pedestrian conflicts at signalized intersections	31

LIST OF TABLES

<u>Table</u>		<u>Page</u>
4	Estimated number of registered vehicles by type, 2002.....	20
5	Fatalities and injuries by mode, 2001	21
6	Total motor vehicle crashes and injury/fatal collisions at signalized intersections by total ADT entering the intersection	21
7	Proportion of crashes by collision type at signalized intersections.....	22
8	Typical dimensions for a sample of types of pedestrians.....	29

2. ROAD USER NEEDS

The purpose of this chapter is to describe road user needs. The description is based on three assumptions:

- Practitioners want to adopt an integrated, systems view founded on human factors principles of the interactions among intersection design, traffic control, environmental factors, and road users.
- The road user—motorist, bicyclist, and pedestrian—is the operative element in the system; decisions affecting user performance taken at any point in the roadway life cycle often involve tradeoffs.
- Practitioners need to fully understand and quantify intersection operations and safety performance in the pursuit of informed and balanced decisionmaking.

A discussion of user needs requires an understanding of human factors principles for all intersection users. This chapter begins with an overview of human factors research and is followed by a description of user needs for motorists, pedestrians, and bicyclists. The chapter concludes with a discussion of applying human factors principles to the planning, design, and operation of signalized intersections.

Documents marked with an asterisk in the reference list provide additional coverage of user needs and human factors and helpful background reading.

2.1 OVERVIEW OF HUMAN FACTORS

Human factors research deals with human physical, perceptual, and cognitive abilities and characteristics and how they affect our interactions with tools, machines, and workplaces. The goal of human factors analysis in road transportation is to:

- Explain, as fully as is possible, the information needs, abilities and characteristics of road users.
- Study the human-machine-situational interactions that occur.
- Capitalize on this knowledge through improvements in engineering design.

At signalized intersections, the application of human factors principles to the problems of safety and efficiency requires an approach that is both systems oriented and human-centered. A systems approach recognizes the interaction between the road user and road/roadway environment. This acknowledges that no one element can be analyzed and understood in isolation. A human-centered approach recognizes road users as the operative element within the system—the decisionmakers—and focuses the engineering effort on optimizing their performance.

Human factors analysis, particularly as it relates to any element of the transportation system (including signalized intersections), includes the following tasks:

- Ensuring road users are presented with tasks that are within their capabilities under a broad range of circumstances.
- Designing facilities that are accessible to and usable by all road users.
- Anticipating how road users may react to specific situations to ensure a predictable, timely, accurate and correct response, thus avoiding situations that violate road users' expectations.
- Designing and applying appropriate traffic control devices so they are conspicuous, legible, comprehensible, credible, and provide sufficient time to respond in an appropriate manner.

- Understanding how geometric design properties of width, enclosure, slope, and deflection affect users and contribute to behaviors such as speeding, yielding, and gap acceptance.

Signalized intersections serve a variety of road users, chiefly motorists, bicyclists, and pedestrians. Within each road user group, there are multiple user types. For example, motorists include passenger car and commercial truck drivers. Bicyclists include recreational and commuting bicyclists, as well as a wide range of ages and abilities. Pedestrians include all age groups (children, adults, elderly), some of whom have cognitive, mobility, or vision impairments. Each road user has unique abilities and characteristics, all of which need to be considered in the design of an intersection.

The basic function of signalized intersections is to sequence right-of-way between intersecting streams of users. These intersections thus serve multiple functions: they allow motorists to access new streets and change directions in travel; they are junctions for bike routes; and they provide a primary connection to and from activity centers for pedestrians. Intersections also serve as public right-of-way and include space for public utilities such as power and communication lines; water, sanitary sewer, and storm drainage pipes; and traffic signs and signal equipment.

Each road user has specific needs traversing an intersection. Motorists and cyclists must detect the intersection on approach, assess its relevance from a navigational perspective, respond to the applicable traffic controls, and negotiate the intersection. In a similar manner, pedestrians must identify the crossing location, maneuver to and position themselves accordingly at the crossing, activate a crossing device, and respond appropriately to the traffic controls. All users must remain vigilant for potential conflicts with other road users.

Under ADA, all people, including those with disabilities, have the right to equal access to transportation.⁽⁷⁾ Designing facilities that cannot be used by people with disabilities constitutes illegal discrimination under the ADA. Designing safe and usable facilities demands an understanding that persons with disabilities have varying abilities, use a variety of adaptive devices, and may have multiple impairments.

Road users are limited in the amount of information they can process. For vehicle drivers and bicyclists, the pace at which information is encountered increases with travel speed. The number of choices facing drivers and bicyclists at any one time should be minimized, and information presented should be concise, complete, explicit, and located sufficiently in advance of the choice point to allow for a comfortable response.

2.1.1 Positive Guidance

In the 1980s, FHWA's Office of Human Factors brought forth a series of documents advocating the explicit application of human factors-based knowledge in the design of roadways and in the design, selection and application of information presentations targeted at vehicle users.⁽⁸⁾

Termed *positive guidance*, the concept focuses on understanding and making allowances for how road users—primarily motorists—acquire, interpret, and apply information in the driving task. Key concepts are those of *driver expectation*, *expectancy violation*, *primacy*, and *road user error*.

Positive guidance places the driving task within the framework of a road environment viewed as an information system, where the driver is the operative element. The roadway, with its formal and informal sources of information, becomes the input. The vehicle, controlled by the driver, becomes the conduit for output. The driving task itself is subdivided into three performance levels: control, guidance, and navigation, each oriented in decreasing order of primacy and increasing order of complexity.

Positive guidance is founded on a simple concept: if drivers are provided with all of the information they need, in a format they can readily read, interpret and apply, and in sufficient time to react appropriately, then the chances of driver error will be reduced, and relative safety will be

improved. Uniformity in the design and context of application of information presentations is a key component of positive guidance. Information presentations must work within the roadway information system to reinforce driver expectations that are correct and restructure those that are not. They must provide the information necessary to support rapid decisionmaking while minimizing the potential for driver error.

Strict interpretation of the positive guidance concept implies telling the driver what he or she needs to know and nothing else. In practical application, positive guidance suggests that competition for driver attention, the presence of information irrelevant to driving-related tasks, as well as exceeding the information-processing limitations of drivers, may have a negative impact on relative safety.

This road user-based approach to information presentation is the foundation of state-of-the-art information presentation policies, standards and guidelines, including FHWA's MUTCD.⁽¹⁾ However, a growing body of research is suggesting that redundancy in message delivery systems may in fact improve the efficiency, safety, and/or usability of a facility. For example, pedestrians tend to begin their crossing more quickly if an audible prompt accompanies the visible pedestrian signal indication. There is always a risk that some users will miss or be unable to receive information that relies on only one sense (e.g., sight).

2.1.2 Roadway Safety

In the past, roads were considered to be “safe” if they were designed, built, operated, and maintained in accordance with nominal standards. These standards were usually based on empirical data or long-standing practice. Collisions were viewed as an unavoidable outcome of the need for mobility and the inevitability of human error. When human errors resulted in collisions, the fault was perceived to lie with the road user, rather than with the road.

The approach to roadway safety has since evolved. In the explicit consideration of roadway safety, safety itself is now recognized to be a relative measure, with no road open to traffic being considered completely “safe”—only “more safe” or “less safe” relative to a particular benchmark, as defined by one or more safety measures. While the concept of “road user error” remains, it is now understood that errors and the collisions that result don't just “happen,” they are “caused,” and that the roadway environment often plays a role in that causation.

In the Institute for Transportation Engineers (ITE) *Traffic Safety Toolbox: A Primer on Traffic Safety*, Hauer refers to *nominal* safety as compliance with standards, warrants, guidelines and sanctioned design procedures, and *substantive* safety as the expected crash frequency and severity for a highway or roadway.⁽⁹⁾

The concept of the “forgiving” roadway—one that minimizes the consequences of road user error by designing out or shielding hazards—has more recently given way to the “caring” roadway. The caring roadway combines all of the forgiving features of its predecessor (crash cushions, clear zones, etc.) with elements that respond to driver capabilities, limitations, expectations, and information needs. The caring roadway seeks to create an operating environment that is user-friendly and simplifies the information presented to the driver, a roadway that is conducive to rapid, error-free performance by the road user.

By attacking the environmental and situational elements that contribute to the occurrence of driver error, the caring roadway seeks to break the chain of causation between the erroneous decisions and/or actions, and their undesirable outcomes (e.g., crashes).

The caring roadway concept is largely information driven. It is predicated on meeting the expectations of road users—motorists, bicyclists, and pedestrians—and assuring that they get needed information, when it is required, in an explicit and usable format, in sufficient time to react. Implicit in the caring roadway approach is that the information-processing capabilities of users must at no time be overtaxed, by either an overabundance of potentially relevant information, or by the additive presence of information not immediately relevant to the task of negotiating the roadway.

2.2 INTERSECTION USERS

Knowing the performance capabilities and behavioral characteristics of road users is essential for designing and operating safe and efficient signalized intersections. All road users have the same human factors, no matter how they use the road. For example, older drivers, older pedestrians, and people with visual disabilities all frequently share the characteristic of longer reaction times. The following section discusses human factor issues common to all road users, followed by a discussion of issues specific to motorists, bicyclists, and pedestrians.

2.2.1 Human Factors Common to All Road Users

The task of traveling on the roadway system, whether by motor vehicle, bicycle, or foot, primarily involves searching for, finding, understanding, and applying information, as well as reacting to the appearance of unanticipated information. Once found and understood, the relevance of this information must be assessed, and decisions and actions taken in response. This activity is cyclic, often occurring many times per second in complex, demanding environments. The capabilities of human vision, information processing, and memory all affect a road user's ability to use an intersection, and these may affect the likelihood of user error. Age plays a role in all of these factors. The following sections discuss each of these factors.

Human Vision

Road users receive most of their information visually. The human visual field is large; however, the area of accurate vision is quite small. Drivers, for example, tend to scan a fairly narrow visual field ahead of them. Drivers do not dwell on any target for long; studies indicate that most drivers become uncomfortable if they cannot look back at the roadway at least every two seconds.⁽¹⁰⁾ This means that information searches and the reading of long messages is carried out during a series of glances rather than with one long look. Complex or cluttered backgrounds, such as that shown in figures 1 and 2, make individual pieces of information more difficult to identify and can make the driving task more difficult. Looking at irrelevant information when it is not appropriate to do so may cause drivers to overlook relevant information, or fail to accurately monitor a control or guidance task. This is of particular concern in areas of high workload, at decision points, and at locations where there is a high potential for conflict (e.g., intersections and crosswalks).



Figure 1. Traffic controls such as official signs need to be close to the road, distinctive from other information presentations, brief, and explicit. This photo provides an example of signs that are close to the road but may be confused with background information.

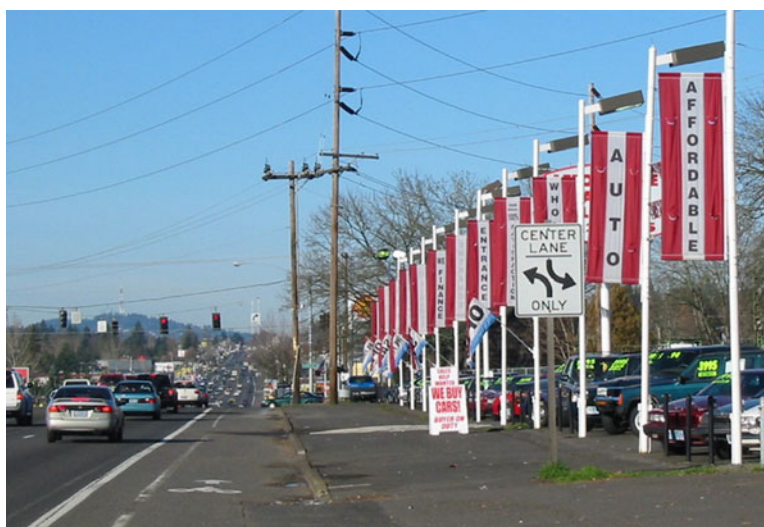


Figure 2. In terms of both official signs and advertising displays, too many displays may have the effect of causing drivers to “tune out,” and recall will be poor. This photo shows an example of sign clutter where the regulatory sign is difficult to isolate from the background advertising signs.

Information Processing

Road users perform best under moderate levels of demand. Overload or underload tends to degrade performance. Consider the example of driving. The presentation of information in circumstances of low driving-task demand is commonly assumed to avert boredom; however, this assumption is untested. During periods of high task demand, however, it is known that the duration of drivers' glances at signs become shorter, as more time is needed to accommodate control and guidance tasks, and less is available for reading signs. Extra effort should be made to limit information presentations to those immediately relevant to the driving task where circumstances of high workload are apt to occur.

Road users are adept at recognizing patterns—clues as to what is upcoming—and using those clues, along with expectations, to anticipate and prepare for situations similar to those experienced before. When things turn out as expected, performance is often rapid and error-free. When expectations are violated, surprise results, and new information must be gathered so the user can rethink a response. Adherence to uniform principles of information presentation in the design and application of traffic control devices—and managing the overall information load placed on road users—is vital to ensure that the users get the information they need, when they need it, in a form that they can recognize and understand, in time to perceive and react to it in an appropriate manner.

Memory

Humans have a limited short-term memory. Only a small percentage of what they see is actually remembered, including information presentations viewed while driving, cycling, or walking. Long-term memory is made up of experiences that have been ingrained through repetition. These are the source of our expectations. Expectations play a strong role in the performance of all road users. Information about an upcoming condition or hazard should be proximate to its location, or repeated at intervals for emphasis.

User Error

There is a common belief that the risk of user error is increased when needed information:

- Is missing or incomplete.
- Is difficult to locate, read or interpret.
- Lacks credibility.
- Leads to false expectations.
- Provides insufficient time for decision and appropriate action.

Information presentations must be conspicuous, legible, readable at a glance, and explicit as to their meaning. Uniformity and consistency are paramount. For example, drivers must receive the same clues and information in similar situations so that their expectations will be consistent with reality, or their expectations will be restructured accordingly. The presentations must be located in advance, to provide time to react, and they must be spaced—both from each other and from other competing sources of information—so as not to confuse or overload the road user.

Drivers in particular often have difficulties in following through the sequence of driving tasks, which leads to driving errors. The most common driving errors include improper lookout (faulty visual surveillance), inattention, false assumption, excessive speed, improper maneuvers, improper evasive action, and internal distraction.⁽¹¹⁾ Cyclists can also have similar difficulties. These errors often result from:

- Inadequate input for the task at hand (e.g., night time travel, poor sight distance, inconspicuous traffic control devices, complex intersection layouts, insufficient advance signing).
- Uncommon events (violations by other road users, emergency vehicles traveling through red light).

- Inappropriate inputs (extraneous or conflicting signage).
- The shedding of important information when overloaded.
- Stress, frustration, inexperience, fatigue, intoxication.
- Imperfect decisionmaking.

In summary, the engineer should be aware of road users and their needs and limitations with regard to signalized intersections. Information displayed in advance of and at the intersection needs to be consistent, timely, legible, and relevant. Awareness of how human factors play a role in the task of using the intersection will go a long way toward reducing error and the collisions this may cause.

Age

Age and experience have a significant effect on the ability of drivers, cyclists, and pedestrians to use an intersection. For example, young drivers have a quicker perception and reaction time yet often lack the judgment to perceive something as being hazardous, something only experience can teach a driver. In contrast, older drivers have the experience yet may lack the perception and reaction time.⁽¹²⁾

According to the FHWA *Highway Design Handbook for Older Drivers and Pedestrians*, half of fatal crashes involving drivers 80 or older took place at intersections.⁽¹²⁾ This document also points to a large body of evidence showing higher crash involvement among older drivers, particularly with crash types that require complex speed-distance judgment under time constraints, such as a left-turn against oncoming traffic.

As one ages, specific functions related to the driving task may deteriorate, such as vision, hearing, sensation, and cognitive and motor abilities. Peripheral vision and a decreased range of motion in an older person's neck may limit their ability to attend to a traffic signal while searching for a gap in traffic when making a left turn. Sorting out visual distractions at intersections can be difficult. Cognitive changes require that older drivers need more time to recognize hazards and respond. It would also appear that driving situations involving complex speed-distance judgments under time constraints as found at many signalized intersections are problematic for older drivers and pedestrians.

The following specific tasks were reported as being problematic for older road users:

- Reading street signs.
- Driving through an intersection.
- Finding the beginning of a left-turn lane at an intersection.
- Judging a gap in oncoming traffic to make a left turn or cross the street (both driving and on foot).
- Following pavement markings.
- Responding to traffic signals.

Little research has been done on the performance and needs of young and inexperienced drivers at signalized intersections. Young drivers aged 16 to 24 have a higher risk (2.5 times) of being involved in a collision compared to other drivers. Young pedestrians (i.e., pedestrians under the age of 12) also have a higher risk of being in a collision. These users may:

- Have difficulty in judging speed, distance, and reaction time.
- Tend to concentrate on near objects and other vehicles.
- Miss important information.
- Have a poor perception of how hazardous a situation can become

- Fix their eyes on an object for longer periods.
- Have difficulty integrating information.
- Be easily distracted by unrelated events (i.e. conversations between passengers and adjusting the stereo).
- Underestimate their risk of being in a collision.
- Make less effective driving and crossing decisions.

2.2.2 Motorists

Motorists account for by far the most number of trips taken on roads. There are more than 225 million licensed vehicles in the United States.⁽¹³⁾ Traffic engineers have traditionally sought to design and operate intersections with the typical driver in mind, trying to best accommodate their needs in terms of their ability to perceive, react, and safely navigate through an intersection. This being so, bicyclists and pedestrians are often at a disadvantage at many intersections.

Road users—drivers, bicyclists, and pedestrians—are not homogeneous in their characteristics, and traffic engineers must be conscious of the need to design for a range of human characteristics and responses. Specific subgroups of drivers may have an elevated risk of being involved in a collision (e.g., teenaged drivers, older drivers, and aggressive drivers).

Most drivers traveling through signalized intersections will be operating passenger vehicles. These may be cars, but in ever-increasing numbers they are minivans, pickups and sports utility vehicles. More than 22,000 fatal collisions in the United States each year involve passenger vehicles.⁽¹⁴⁾ However, commercial vehicles (tractor-trailers, single-unit trucks, and cargo vans) account for more than their share of fatal collisions, based on fatal crash rates per mile.⁽¹⁵⁾ These vehicles need to be properly accommodated at intersections. Vehicle acceleration from a stationary position, braking distances required, safe execution of a left or right turn, and provision of adequate storage in turning lanes are important items that should be considered.

Table 4 identifies general characteristics of vehicle types, and table 5 shows the frequency of fatalities and injuries by mode.

Table 4. Estimated number of registered vehicles by type, 2002.

Vehicle Type	Number of Registered Vehicles	Percent of Total
Passenger car (convertibles, sedans, station wagons)	133.6 million	59
Other 2-axle, 4-tire vehicles (pick-up trucks, vans, sport utility vehicles)	79.1 million	35
Motorcycles	4.3 million	2
Truck, single unit	5.9 million	3
Truck, combination	2.1 million	1
Bus	0.8 million	< 1
Total	225.8 million	

Source: Bureau of Transportation Statistics, 2002.⁽¹⁶⁾

Table 5. Fatalities and injuries by mode, 2001.

Mode	Fatalities	Percent of Total	Injuries	Percent of Total
Passenger car occupants (all types)	20,233	48	1,926,625	64
Truck occupants ¹	12,381	29	889,951	29
Motorcyclists	3,181	8	60,236	2
Bus occupants	34	< 1	15,427	1
Pedestrians	4,882	12	77,619	3
Bicyclists	728	2	45,277	1
Other	677	1	17,536	1
Total	42,116		3,032,672	

¹ Includes single-unit trucks, truck tractors, pickups, vans, truck-based station wagons, and utility vehicles.

Source: Bureau of Transportation Statistics, 2001⁽¹⁷⁾

Crash data from the Highway Safety and Information System (HSIS) database for the State of California were summarized to identify the proportion of crashes by ranges of Average Daily Traffic (ADT) for movements entering the intersection and the proportion of crashes by collision type. The HSIS data includes all reported crashes at signalized intersections for the period between 1994 and 1998. Table 6 presents a summary of total and injury/fatal crashes by volume, and table 7 presents the results and identifies the proportion of crashes by collision type for signalized intersection based on the California HSIS data.

Table 6. Total motor vehicle crashes and injury/fatal collisions at signalized intersections by total ADT entering the intersection.

ADT	Intersections (percent of total)	Total Crashes (percent of total)	Injury/Fatal Crashes (percent of total)
<20000	16	8	7
20,000-40,000	45	40	38
40,000-60,000	29	36	37
60,000-80,000	8	13	14
80,000 and more	2	3	4
TOTAL	100	100	100

Source: HSIS California database, 1994-1998⁽¹⁸⁾

As shown in table 6, the 20,000 to 40,000 ADT and 40,000 to 60,000 ADT ranges represent the greatest percentage of signalized intersections from the database and have the highest percentage of total crashes and injury/fatal crashes. The percentage of total and injury/fatal crashes that occurred in the 40,000-60,000 ADT range is similar; however, the proportion of intersections in this range is much smaller.

Table 7. Proportion of crashes by collision type at signalized intersections.⁽¹⁸⁾

Collision Type	Percent
Head on	3
Sideswipe	12
Rear end	42
Broadside	28
Fixed object	6
Overtaken	0
Pedestrian	3
Other	6
TOTAL	100

As shown in table 7, the most frequently occurring collision is a rear-end crash, which represents 42 percent of all reported intersection crashes in the database.

Vehicle Dimensions

Motor vehicle needs at a signalized intersection are governed by the dimensions of the design vehicle, which is the largest vehicle reasonably expected to use the intersection. Commonly, WB-15 (WB-50) vehicles, or truck/trailer combinations with a wheelbase of 15 m (50 ft), are the largest vehicles along many arterials. However, many signalized intersections are located on State highways where the design vehicle is an interstate vehicle such as a WB-20 (WB-67), or a truck/trailer combination with a wheelbase of 20 m (67 ft). Specific information on the dimensions for these and other design vehicles can be found in standard references.⁽³⁾

Design vehicles need to be carefully considered wherever they are expected to make a turning movement through the intersection. Affected elements include corner radii, channelization islands, median noses, and stop bar locations. In accommodating the design vehicle, however, tradeoffs for other users need to be acknowledged, such as the increase in pedestrian crossing distance or the accommodation of cyclists around channelization islands.

Red Light Running

One primary cause of collisions at signalized intersections is when a motorist enters an intersection when the red signal is displayed, and as a consequence collides with another motorist, pedestrian, or bicyclist who is legally within the intersection. It is estimated that approximately 750 fatalities and 150,000 injuries occur on a yearly basis due to red light running. A study of HSIS data determined that red light runners cause 16 to 20 percent of all collisions at signalized intersections.⁽¹⁹⁾

Red light running may occur due to poor engineering, distraction, inattention, or willful disregard. Those who deliberately violate red lights tend to be younger, male, less likely to use seat belts, have poorer driving records, and drive smaller and older vehicles.

Countermeasures proposed to address red light running are removal of unwarranted traffic signals, changing the signal timing, improving the visibility of the traffic signal, or enforcement. An example of red light running enforcement cameras is given in figure 3.



Figure 3. Enforcement cameras, as shown in the photo above, are used at signalized intersections to identify red light runners.

Driver Distraction

Despite the complexity of the driving task, it is not uncommon to see drivers engaging in other tasks while operating a motor vehicle. While these tasks may seem trivial, they take the attention of the driver away from the task of driving. One report estimated that 13 percent of all collisions occur due to driver distraction. Drivers involved in collisions at intersections were more likely to report that they “looked but didn’t see.” Drivers involved in intersection collisions as opposed to other driving situations reported that they were more likely to be distracted by:⁽²⁰⁾

- An outside person, object, or event.
- Another occupant in the vehicle.
- Vehicle and climate controls.
- Eating food.
- Using or dialing a cell phone.

2.2.3 Bicyclists

Bicycle travel is an important component of any multimodal transportation system. Bicycle travel is healthy, cost effective, energy efficient, and environmentally friendly. Traditionally, the most popular form of bicycle travel is recreational cycling. Given the increases in traffic congestion over the past few decades, particularly in urban areas, the number of people that use bicycles to commute to work is on the rise.⁽²¹⁾

Bicyclists have unique needs at signalized intersections. Bicyclists are particularly vulnerable because they share the roadway with motorists and follow the same rules of the road, yet they do not possess nearly the same attributes in size, speed, and ability to accelerate as their motor vehicle counterparts. Consequently, roadway characteristics such as grades, lane widths, intersection widths, and lighting conditions influence the safety and operations of bicyclists to a larger degree than they do for vehicles. External conditions such as inclement weather also significantly affect bicyclists’ performance.

Providing safe, convenient, and well-designed facilities is essential to encourage bicycle use.⁽²¹⁾ To accomplish this, planning for bicycle use, whether existing or potential, should be integrated into the overall transportation planning process.

Providing a safe and attractive environment for bicyclists requires special attention to the types of bicycle users, their characteristics and needs, and factors that influence bicyclist safety.

Bicycle Users

Bicyclists range widely in terms of skills, experience, and preferences. A 1994 report by FHWA defined the following general categories (A, B, and C) of bicycle user types:⁽²²⁾

- “**A**dvanced or experienced riders are generally using their bicycles as they would a motor vehicle. They are riding for convenience and speed and want direct access to destinations with a minimum of detour or delay. They are typically comfortable riding with motor vehicle traffic; however, they need sufficient operating space on the traveled way or shoulder to eliminate the need for either [them] or a passing motor vehicle to shift position.
- “**B**asic or less confident adult riders may also be using their bicycles for transportation purposes, e.g., to get to the store or to visit friends, but prefer to avoid roads with fast and busy motor vehicle traffic unless there is ample roadway width to allow easy overtaking by faster motor vehicles. Thus, basic riders are comfortable riding on neighborhood streets and shared use paths and prefer designated facilities such as bike lanes or wide shoulder lanes on busier streets.
- “**C**hildren, riding on their own or with their parents, may not travel as fast as their adult counterparts but still require access to key destinations in their community, such as schools, convenience stores and recreational facilities. Residential streets with low motor vehicle speeds, linked with shared use paths and busier streets with well-defined pavement markings between bicycle and motor vehicle, can accommodate children without encouraging them to ride in the travel lane of major arterials” (cited on p. 6, reference 22).

Bicyclist Dimensions

Bicyclists require at least 1.0 m (40 inches) of operating space, with an operating space of 1.2 m (4 ft) as the minimum width for bike lanes or other facilities designed for exclusive one-way or preferential use by bicyclists (see figure 4). For facilities where motor vehicle volumes, motor vehicle or bicyclist speed, and the mix of truck and bus traffic increase, such as most high-volume signalized intersections, a more comfortable operating space of 1.5 m (5 ft) or more is desirable.⁽²²⁾ In addition, because most bicyclists ride a distance of 0.8 to 1.0 m (32 to 40 inches) from a curb face, this area should be clear of drain inlets, utility covers, and other items that may cause the bicyclist to swerve.⁽²²⁾ Where drain inlets are unavoidable, their drainage slots should not run parallel to the direction of travel, as these can cause a bicyclist to lose control.

Bicycle User Needs

The general objectives for bicycle travel are similar to those for other modes: to get from point “A” to point “B” as efficiently as possible on a route that is safe and enjoyable. At the same time, the mode of travel must integrate with other forms of transportation that use the roadway network and not adversely affect other modes or uses.

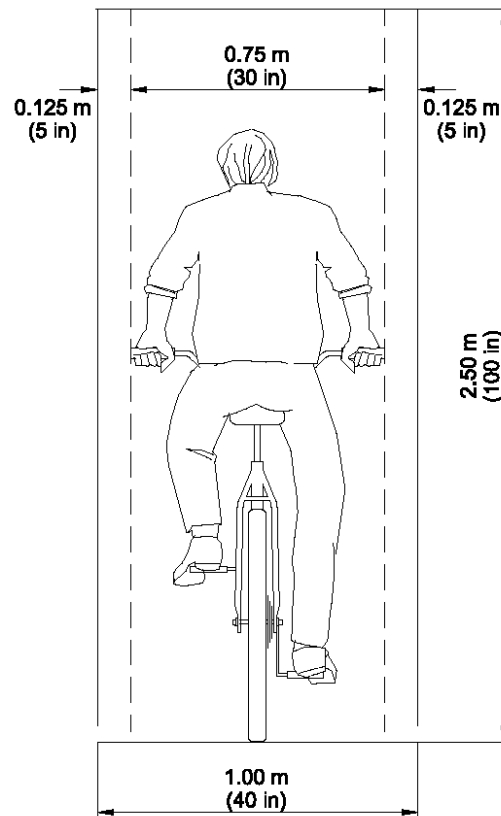


Figure 4. Typical dimensions of a bicyclist.

- Width—1.2 m (4 ft) design minimum for exclusive bicycle lanes; 1.5 m (5 ft) design minimum where motor vehicle traffic volumes, motor vehicle or bicyclist speed, and/or the mix of truck and bus traffic increase; bicycle lane width is the affected intersection feature.
- Length—1.8 m (5.9 ft), median island width at crosswalk is the affected intersection feature.
- Lateral clearance on each side—0.6 m (2.0 ft); 1.0 m (3.3 ft) to obstructions; shared bicycle-pedestrian path width is the affected intersection feature.

Sources: (22); (6), as adapted from (23)

The Danish Road Directorate identifies key elements to incorporate in the planning of cycling facilities:

- **Accessible and coherent.** The cycle network should run directly from residential areas to the most important destinations such as schools, workplaces, and shopping and entertainment centers.
- **Direct and easy.** If the cycle network is not direct, logical, and easy to use, some cyclists will choose roads not planned for bicycle traffic.
- **Safe and secure.** Adequate visibility and curve radii should make it possible for cyclists to travel safely at a minimum of 25 km/h (15 mph). Parked cars, vegetation, barriers, etc. can result in poor or reduced visibility. Awareness of presence of bicyclists can be heightened by signing and road marking.
- **Self-explanatory design.** Edge lines, bicycle symbols, colored tracks and lanes, and channelization of traffic make it easy to understand where cyclists should place themselves. Uniformity over long stretches is an important component.

Other elements that should be considered in the planning and design of bicycle facilities include bike lanes, pavement surface conditions, drainage inlet grates, refuge, and lighting.⁽²⁴⁾

Bicycle Safety

In 2001, the National Highway Traffic Safety Administration (NHTSA) reported that 728 bicyclists were killed and 45,000 injured in motor vehicle crashes.⁽²⁵⁾ However, many bicycle crashes either do not involve a motor vehicle or go unreported. A study of records at eight hospitals in three States found that 55 percent of bicycle injury events in a roadway did not involve a motor vehicle.⁽²⁶⁾ In addition, the study found that 40-60 percent of bicycle-motor vehicle crashes were not reported to the official State files.

Bicycle-motor vehicle crashes are a concern at intersections. An FHWA report identified four common crash types, three of which occur at intersections:⁽²⁷⁾

- Motorist left turn facing the bicyclist.
- Bicyclist left turn in front of traffic.
- Motorist drive-out from a driveway or alley.
- Bicyclist ride-out from a stop sign or flashing red signal.

Figure 5 presents the typical conflicts for bicyclists at a signalized intersection. As the exhibit shows, bicyclists going straight through a signalized intersection encounter the same conflicts as a motor vehicle (shown in the exhibit as open circles) but also encounter conflicts from motor vehicles turning right from the same direction.

Left turns for bicyclists are even more complex and depend on the type of bicyclists. For small- to medium-sized signalized intersections, Category A and some Category B cyclists will generally choose to take the lane as a motor vehicle, as it is the fastest way through the intersection; the remainder will likely feel more comfortable traveling as a pedestrian, as shown in figure 5. As the size of the intersection increases, the difficulty for cyclists to weave to the left turn lane can be daunting for Category B and even some Category A cyclists.

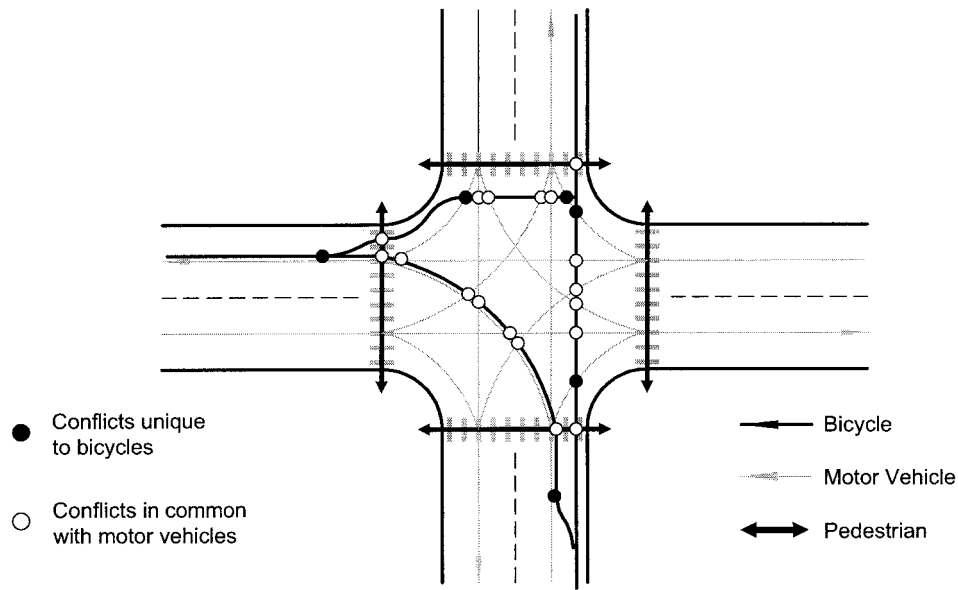


Figure 5. Bicyclist conflicts at signalized intersections.

Research confirms that the conflicts described above result in high risk for bicyclists at signalized intersections. Geary examined nearly 4,000 bicycle fatalities recorded on American roads during the period 1994-1998 with the use of the Fatality Analysis Reporting System database maintained by NHTSA.⁽²⁸⁾ The research indicated that intersections are far more involved in the injury-producing bicyclist crashes (73 percent) than in the fatal crashes (37 percent). Intersection-related fatalities are far more common on urban rather than rural roads, and during daylight instead of after dark. Recent trends suggest that adults are becoming more involved in collisions involving bicycles, while children are becoming less involved.

An analysis of police-reported collisions between bicyclists and motorists that occurred in Toronto, Canada, indicated that 17 percent of bicycle collisions occur at signalized intersections.⁽²⁹⁾ In just over half of these crashes, the cyclist was struck while crossing the intersection within the pedestrian crosswalk.

A Vancouver study found that the risk for collision while cycling is approximately three times higher than for driving a motor vehicle over the same distance.⁽³⁰⁾ The ratio varies between 2:1 and 6:1 in other British Columbia jurisdictions. Right-angle collisions were the most frequent collision type (28 percent of all collisions). Collisions that occur at signalized intersections accounted for 17 percent of all collisions.

2.2.4 Pedestrians

Walking is the oldest and most basic form of transportation. Nearly every trip includes a walking element. According to the *2001 Nationwide Personal Transportation Survey*, 8.6 percent of all daily trips occurred via the walk mode.⁽³¹⁾ People walk for a variety of reasons: social and recreational activities, trips to school or church, shopping, commuting to and from work, and connecting to or from other modes of transportation. Activities often concentrate on the corners of intersections where pedestrian streams converge, people interact and socialize, and people wait for crossing opportunities.

The variety of pedestrian users includes persons of all ages, with and without disabilities, persons in wheelchairs, and persons with strollers, freight dollies, luggage, etc; an example is given in figure 6. The design of intersection facilities should accommodate all types of pedestrians, because the user cannot be anticipated.



Figure 6. Examples of pedestrians of various abilities preparing to cross an intersection.

Pedestrian Dimensions

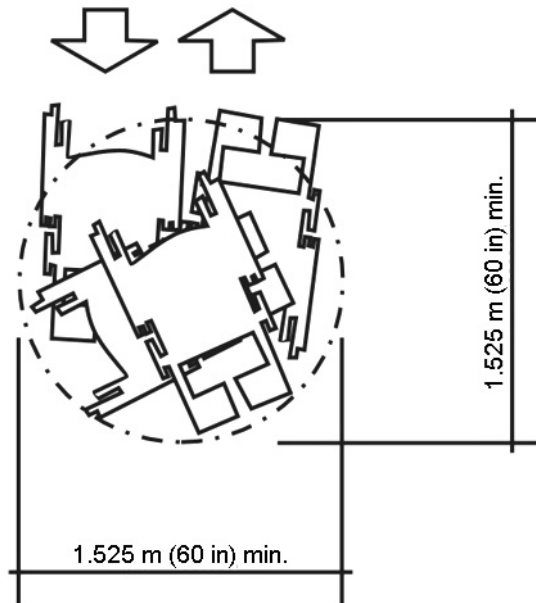
Research has shown that the ambulatory human body encompasses an ellipse of 45 by 60 cm (18 by 24 inches).⁽³²⁾ This dimension, however, does not account for a variety of scenarios, including pedestrians walking side by side; persons using canes, walkers, dog guides, or wheelchairs; persons with shopping carts or baby carriages, and so on. Table 8 shows dimensions for various types of pedestrians.

The Americans with Disabilities Act Accessibility Guidelines (ADAAG), specifies a 1.525-m (60-inch) square area to allow a wheelchair user to make a 180-degree turn (figure 7).⁽³³⁾ For parallel approaches, ADAAG specifies a minimum low-side reach of 0.23 m (9 inches) and a maximum high-side reach of 1.37 m (54 inches). For a forward approach, ADAAG specifies a minimum low-reach point of 0.38 m (15 inches) and a maximum high-reach point of 1.22 m (48 inches).

Table 8. Typical dimensions for a sample of types of pedestrians.

User and Characteristic	Dimension	Affected Intersection Features
Pedestrian (walking) Width	0.5 m (1.6 ft)	Sidewalk width, crosswalk width
Wheelchair Minimum width	0.75 m (2.5 ft)	Sidewalk width, crosswalk width, ramp landing areas
Operating width	0.90 m (3.0 ft)	
Person pushing stroller Length	1.70 m (5.6 ft)	Median island width at crosswalk
Skaters Typical operating width	1.8 m (6 ft)	Sidewalk width

Source: (6), as adapted from (23).



Source: (Reference 33, figure 3a)

Figure 7. Typical dimensions for a turning wheelchair.

Pedestrian Characteristics

Pedestrian walking speeds generally range between 0.8 to 1.8 m/s (2.5 to 6.0 ft/s).⁽³⁾ The MUTCD uses a walk speed of 1.2 m/s (4.0 ft/s) for determining crossing times.⁽¹⁾ However, FHWA pedestrian design guidance recommends a lower speed of 1.1 m/s (3.5 ft/s) in general to accommodate users who require additional time to cross the roadway, and in particular a lower speed in areas where there are concentrations of children and or elderly persons.^(34,35) The *HCM 2000* indicates that if elderly persons constitute more than 20 percent of the total pedestrians, the average walking speed decreases to 0.9 m/s (3.0 ft/s).⁽²⁾



Figure 8. Crosswalks are used by a variety of users with different speed characteristics. Pedestrian walking speeds generally range between 0.8 to 1.8 m/s (2.5 to 6.0 ft/s).

A general rule of thumb indicates that pedestrians at crossings are willing to wait only 30 seconds, at which point they will begin to look for opportunities to cross, regardless of the walk indication and the crossing location (reference 7, chapter 18 of *HCM 2000*).⁽²⁾ Shorter cycle lengths benefit pedestrians, particularly where pedestrians often need to cross two streets at a time to travel in a diagonal direction, as well as drivers, who experience generally shorter delays.

Pedestrian Conflicts

Figure 9 presents the typical conflicts between pedestrians and motor vehicles at a signalized intersection.

- *Vehicles turning right on red.* Where allowed by law, this conflict occurs most often when the driver of a vehicle turning right on red is looking to the left and does not perform an adequate search for pedestrians approaching from the right and crossing perpendicularly to the vehicle. In addition, the sound of vehicles turning right on red masks audible cues used by blind pedestrians to determine the beginning of the crossing phase.
- *Vehicles turning right on green.* This conflict occurs when vehicles do not yield to a pedestrian crossing in the parallel crosswalk.
- *Vehicles turning left on green.* This conflict occurs at intersections with permissive left turns where vehicles may be focused on selecting an acceptable gap in oncoming vehicular traffic and do not see and/or yield to a pedestrian in the conflicting crosswalk.
- *Vehicles running the red light.* This conflict is the most severe due to the high vehicular speeds often involved.

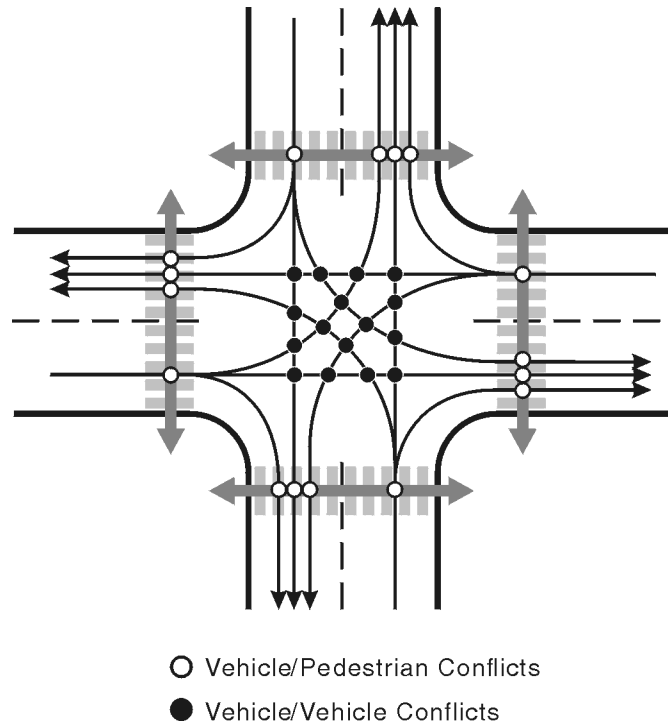


Figure 9. Pedestrian conflicts at signalized intersections.

In addition, large signalized intersections with multiple lanes on each approach present the pedestrian with the possibility of having a vehicle in one lane yield but having a vehicle in the adjacent lane continue without yielding. The vehicle that has yielded may block the pedestrian's and other motorist's view of each other, thus putting the pedestrian at greater risk. This type of conflict may be present at signalized intersections in the following situations:

- *Double right-turn movements.* These may be in the form of either two exclusive right-turn lanes or one exclusive right-turn lane and a shared through-right lane.
- *Permissive double left-turn movements.* These are not common but are used in some jurisdictions, either with permissive-only phasing or with protected-permissive phasing.

Pedestrian Safety

The safety of pedestrians must be a particular concern at signalized intersections, particularly those with a high volume of motorized vehicles. Pedestrians are vulnerable in an environment surrounded by large, powerful, and fast-moving vehicles. Data from the Bureau of Transportation Statistics shows that in 2001, there were a total of 4,882 pedestrian fatalities involved in motor vehicle crashes; this represents 12 percent of all the 42,116 motorist collisions. More than 77,000 pedestrians were injured in motor vehicle collisions during this time.⁽¹⁷⁾

Of all crashes between single vehicles and pedestrians in 2001, 940 (22 percent) occurred at intersections (both signalized and unsignalized).⁽³⁶⁾ Speed plays a major role in motorist-pedestrian collisions, particularly fatalities; a pedestrian struck at 65 km/h (40 mph) has an 85-percent chance of being killed, at 48 km/h (30 mph) the probability of fatality is 45 percent, and at 30 km/h (20 mph) the probability of fatality drops to 5 percent.⁽³⁷⁾ Compounding the problem, motorists rarely stop to yield to a pedestrian when their speeds are greater than 70 km/h (45 mph); they are likely to stop when their speeds are less than 30 km/h (20 mph).⁽³⁸⁾

From the driver's perspective, the mind goes through five psychological steps to "see" an object such as a pedestrian: selection, detection, recognition, location, and prediction. The speed of the vehicle and the experience of the driver play critical roles in the driver's ability to detect pedestrians and react appropriately. Research shows that difficulties in information processing and driver perception contribute to approximately 40 percent of all traffic crashes involving human error.⁽³⁸⁾

The time required for a driver to detect a pedestrian, decelerate, and come to a complete stop is oftentimes underestimated, or worse yet, not even considered as part of the geometric design of an intersection. AASHTO's *A Policy on Geometric Design of Highways and Streets* recommends a brake reaction time of 2.5 s for determining stopping sight distance.⁽³⁾ Additional research has suggested that the value of 2.5 s has limitations and represents nearly ideal conditions with younger, alert drivers.⁽³⁹⁾ Research conducted by Hooper and McGee suggests that a perception-reaction time of 3.2 s is more reasonable.⁽⁴⁰⁾ Even then, the reaction time assumes an expected or routine condition such as a vehicle turning into or out of a driveway — more time is needed to account for an unexpected condition, such as a child darting into the street. A conservative perception-reaction time estimate for a "surprise" condition is 4.8 s.⁽³⁸⁾ Many things can impact the sight distance that allows the driver and pedestrian to see each other: landscaping, parked vehicles, traffic control devices, street furniture, etc. The practitioner must be mindful of these elements, particularly given that two-dimensional plans do not necessarily reflect the three-dimensional field of vision from the pedestrian and driver vantage points.

The combination of vehicle speed and visibility (or lack thereof) is a critical reason that the majority of motorists involved in pedestrian collisions claim that they "did not see them until it was too late."⁽³⁸⁾

Accessibility for pedestrians is also a key element. The ADA of 1990 mandates, among other things, that transportation facilities be accessible for all persons.⁽⁷⁾ This requires that new or altered facilities be designed to allow pedestrians of all abilities to identify the crossing location, access the pushbutton, know when to cross, and know where to cross. The Americans with Disabilities Act Accessibility Guidelines published by the U.S. Access Board in 1991 identify minimum design standards that must be applied to all new construction or alteration projects to adequately accommodate persons with disabilities.⁽³³⁾ The accommodation of all users needs to be included into the construction cost of an improvement. Note that facilities that are designed above the minimum standards generally improve the safety and accessibility for all pedestrians.

2.3 APPLYING HUMAN FACTORS

To achieve error-free road user performance at signalized intersections, the information necessary to permit relatively safe performance in an inherently hazardous environment must be effectively communicated. The design of the roadway network, including the intersections, should inherently convey what to expect to the various users. Road users must receive information in a form they can read, understand, and react to in a timely fashion. This information must reinforce common road user expectations, or if uncommon elements are present, emphatically communicate alternative information with sufficient time to react.

Failure to fully and adequately communicate the circumstances to be encountered by the road user increases the risk of hesitation, erroneous decisionmaking and incorrect action. Road users will rely on experience rather than their perceptions (however incomplete) of the situation at hand when their expectations are not met.

A fundamental premise of human factors is that insufficient, conflicting, or surprising information reduces both the speed and accuracy of human response. The following bullet items offer key information regarding the application of human factors principles in the analysis and design of a signalized intersection:

- All road users must first recognize signalized intersections before they can respond.

- All road users must have a clear presentation of the intersection on approach, or be appropriately forewarned by traffic control devices.
- Adequate illumination for nighttime operations is required.
- Navigational information must be available sufficiently in advance to allow for speed and path adjustments such as slowing to execute turns and lane changes.
- Signal indications must be visible from a sufficient approach distance for the user to perceive and react to changes in the assignment of right-of-way and the presence of queued traffic in a safe manner, according to table 4D-1 of the MUTCD.⁽¹⁾
- Phasing and clearance intervals for both vehicles and pedestrians must be suited to the characteristics and mix of road users using the intersection.
- The geometric aspects of the intersection, such as the presence of medians, curb radius, lane width, and channelization, and the implications of lane choices, must be clear.
- Points of potential conflict, particularly those involving vulnerable road users, must be evident and offer the approaching driver and pedestrian a clear view of each other.
- The route through the intersection itself must be explicit, to avoid vehicles encroaching on each other.

CHAPTER 3

GEOMETRIC DESIGN

TABLE OF CONTENTS

3.0	GEOMETRIC DESIGN	37
3.1	Channelization	37
3.2	Number of Intersection Legs.....	44
3.3	Intersection Angle	45
3.4	Horizontal and Vertical Alignment.....	46
3.5	Corner Radius and Curb Ramp Design	46
3.5.1	Corner Radius.....	47
3.5.2	Curb Ramp Design	47
3.5.3	Detectable Warnings.....	51
3.6	Sight Distance	53
3.6.1	Stopping Sight Distance.....	53
3.6.2	Decision Sight Distance	53
3.6.3	Intersection Sight Distance	54
3.7	Pedestrian Facilities.....	54
3.8	Bicycle Facilities.....	55

LIST OF FIGURES

<u>Figure</u>		<u>Page</u>
10	The photograph shows a raised median that restricts left-turn egress movements from a driveway located between two signalized intersections.....	38
11	Pavement markings can be used to delineate travel lanes within wide intersections as shown in the photograph	39
12	Various right-turn treatments may be used, depending on the speed environment.....	40
13	Providing a dedicated left-turn lane reduces potential collisions between left-turning and through vehicles, increasing the capacity of the approach for both left and through traffic.....	41
14	The photo shows how double left-turn and double right-turn lanes can be used to accommodate high-priority movements	42
15	Intersection skew increases both the intersection width and pedestrian crossing distance.	43
16	The photograph illustrates a multileg intersection	44
17	Potential conflicts at intersections with three and four legs.....	45
18	Curb ramp components	48
19	Examples of preferred designs	50
20	Examples of acceptable curb ramp designs.....	50
21	Examples of inaccessible designs.....	50
22	This crosswalk design incorporates the use of detectable warning surfaces into the curb ramps to facilitate navigation by a visually impaired pedestrian	51

LIST OF TABLES

<u>Table</u>		<u>Page</u>
9	Summary of best practices for curb ramp design and associated rationale.....	49
10	Requirements for detectable warning surfaces	52
11	Design values for stopping sight distance	53
12	Design values for decision sight distance for selected avoidance maneuvers	54

3. GEOMETRIC DESIGN

This chapter presents geometric design guidelines for signalized intersections based on a review of technical literature and current design policy in the United States.

Geometric design of a signalized intersection involves the functional layout of travel lanes, curb ramps, crosswalks, bike lanes, and transit stops in both the horizontal and vertical dimensions. Geometric design has a profound influence on roadway safety; it shapes road user expectations and defines how to proceed through an intersection where many conflicts exist.

In addition to safety, geometric design influences the operational performance for all road users. Minimizing impedances, eliminating the need for lane changes and merge maneuvers, and minimizing the required distance to traverse an intersection all help improve the operational efficiency of an intersection.

The needs of all possible road users (see chapter 2) must be considered to achieve optimal safety and operational levels at an intersection. At times, design objectives may conflict between road user groups; the practitioner must carefully examine the needs of each user, identify the tradeoffs associated with each element of geometric design, and make decisions with all road user groups in mind.

This chapter addresses the following topics:

- Principles of channelization.
- Number of intersection approaches.
- Intersection angle.
- Horizontal and vertical alignment.
- Corner radius and curb ramp design
- Detectable warnings.
- Access control.
- Sight distance.
- Pedestrian facilities.
- Bicycle facilities.

3.1 CHANNELIZATION

A primary goal of intersection design is to limit or reduce the severity of potential road user conflicts. Basic principles of intersection channelization that can be applied to reduce conflicts are described below.⁽⁴¹⁾

1. **Discourage undesirable movements.** Designers can utilize corner radii, raised medians, or traffic islands to prevent undesirable or wrong-way movements. Examples include:

- Preventing left turns from driveways or minor streets based on safety or operational concerns.
- Designing channelization to prevent wrong way movements onto freeway ramps, one-way streets, or divided roadways.
- Designing approach alignment to discourage undesirable movements.

Figure 10 shows how a raised median can be used to restrict undesirable turn movements within the influence of signalized intersections.



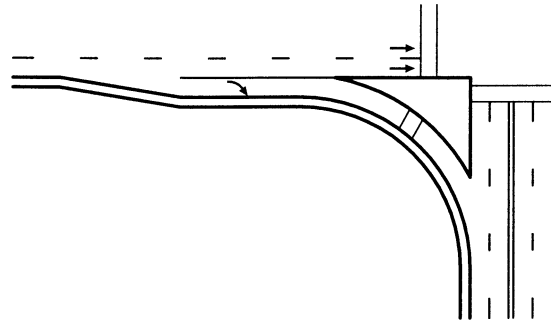
Figure 10. The photograph shows a raised median that restricts left-turn egress movements from a driveway located between two signalized intersections.

2. Define desirable paths for vehicles. The approach alignment to an intersection as well as the intersection itself should present the roadway user with a clear definition of the proper vehicle path. This is especially important at locations with “unusual” geometry or traffic patterns such as highly skewed intersections, multileg intersections, offset-T intersections and intersections with very high turn volumes. Clear definition of vehicle paths can minimize lane changing and avoid “trapping” vehicles in the incorrect lane. Avoiding these undesirable effects can improve both the safety and capacity at an intersection. Figure 11 shows how pavement markings can be applied to delineate travel paths.

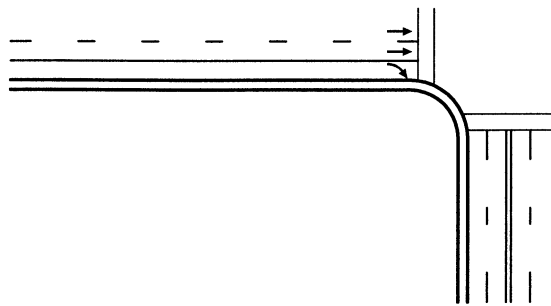


Figure 11. Pavement markings can be used to delineate travel lanes within wide intersections as shown in the photograph.

3. **Encourage safe speeds through design.** An effective intersection design promotes desirable speeds to optimize intersection safety. The appropriate speed will vary based on the use, type, and location of the intersection. On high-speed roadways with no pedestrians, it may be desirable to promote higher speeds for turning vehicles to remove turning vehicles from the through traffic stream as quickly and safely as possible. This can be accomplished with longer, smooth tapers and larger curb radii. On low-speed roadways or in areas with pedestrians, promotion of lower turning speeds is appropriate. This can be accomplished with smaller turning radii, narrower lanes, and/or channelization features. These are illustrated in figure 12.



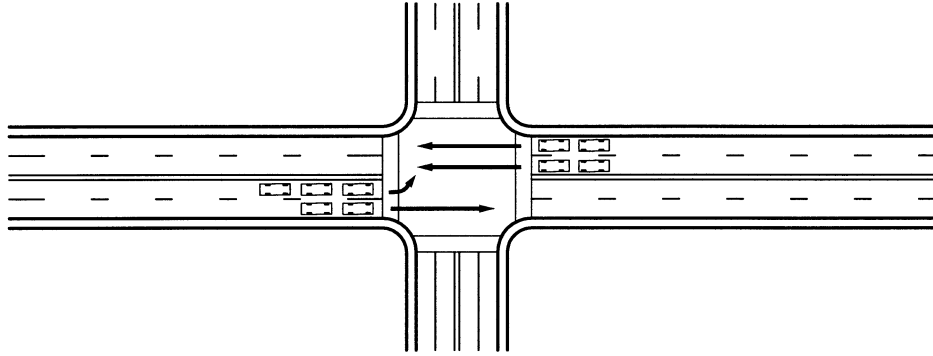
(a) Higher speed design



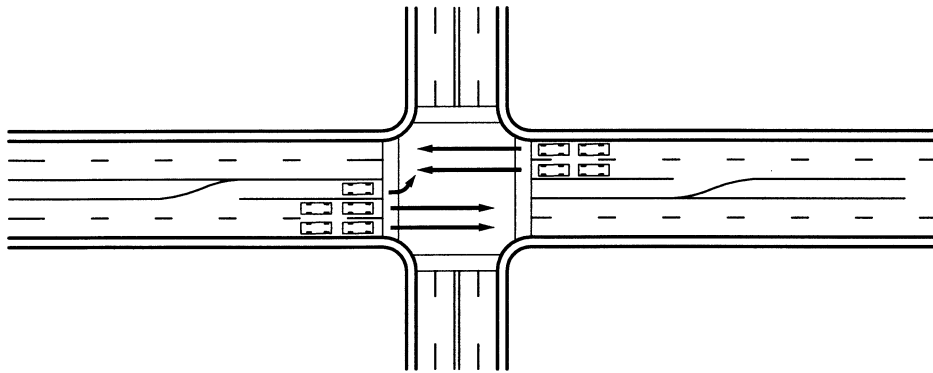
(b) Lower speed design

Figure 12. Various right-turn treatments may be used, depending on the speed environment.

4. **Separate points of conflict where possible.** Separation of conflict points can ease the driving task while improving both the capacity and safety at an intersection. The use of exclusive turn lanes, channelized right turns, and raised medians as part of an access control strategy are all effective ways to separate vehicle conflicts. Figure 13 illustrates how the addition of a left-turn lane can reduce conflicts with through vehicles traveling in the same direction.



(a) Major street with shared left-through lane causes through vehicles to queue behind left-turning vehicles.



(b) Major street with dedicated left-turn lane removes left-turning vehicles from the paths of through vehicles.

Figure 13. Providing a dedicated left-turn lane reduces potential collisions between left-turning and through vehicles, increasing the capacity of the approach for both left and through traffic.

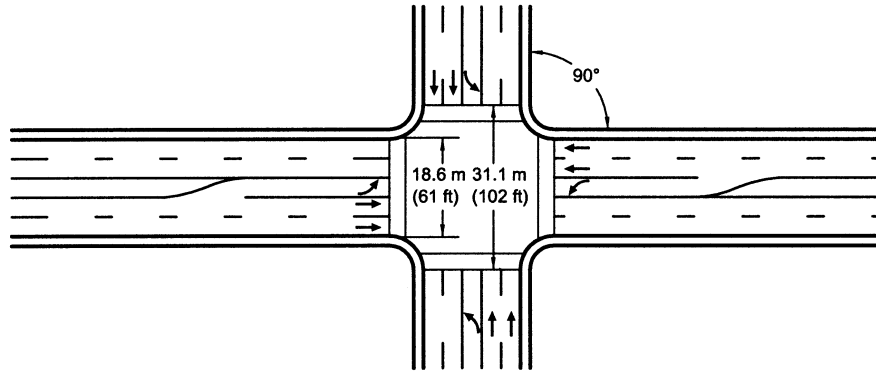
5. Facilitate the movement of high-priority traffic flows. Accommodating high-priority movements at intersections addresses both driver's expectations and intersection capacity. The highest volume movements at an intersection typically define the intersection's high-priority movements, although route designations and functional classification of intersecting roadways may also be considered. In low-density suburban and rural areas, it may be appropriate to give priority to motor vehicle movements; however, in some urban locations, pedestrians and bicyclists at times may be the highest priority users of the road system. Figure 14 shows an intersection where double left and right turn lanes are used to facilitate high-volume turning movements.



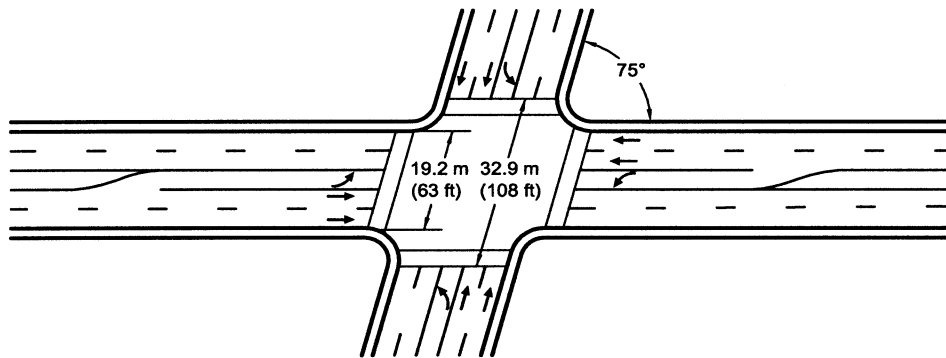
Photograph Credit and Copyright: www.portlandmaps.com, 2004

Figure 14. The photo shows how double left-turn and double right-turn lanes can be used to accommodate high-priority movements.

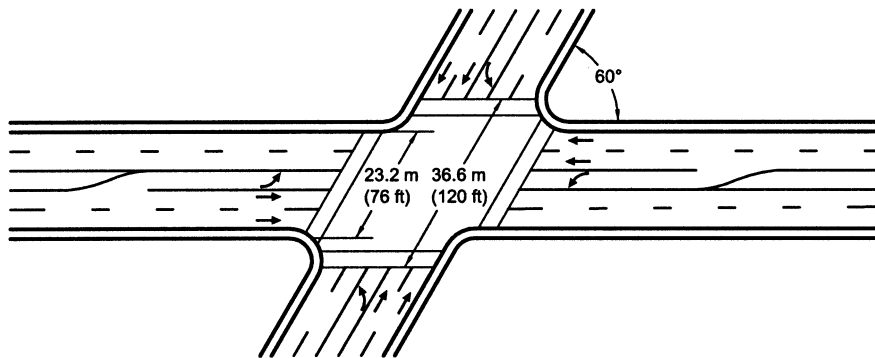
6. Design approaches to intersect at near right angles and merge at flat angles. Roadway alignments that cross as close to 90 degrees as practical can minimize the exposure of vehicles to potential conflicts and reduce the severity of a conflict. Skewed crossings produce awkward sight angles for drivers, which can be especially difficult for older drivers. Skewed crossings also result in additional distance for vehicles to traverse the intersections. This additional distance should be considered when developing the timing for a signal, as it may require the need for additional all-red clearance time. Figure 15 shows how a skewed intersection approach can increase the distance to clear the intersection for pedestrians and vehicles.



(a) Intersection skew at 90 degrees.



(b) Intersection skew at 75 degrees.



(c) Intersection skew at 60 degrees.

Figure 15. Intersection skew increases both the intersection width and pedestrian crossing distance.

7. Facilitate the desired scheme of traffic control. The design of a signalized intersection should attempt to maximize traffic safety and operations while providing operational flexibility. Lane arrangements, location of channelization islands, and medians should be established to facilitate pedestrian access and the placement of signs, signals, and markings. Consideration of these “downstream” issues as part of design can optimize the operation of an intersection. Providing exclusive left-turn bays that can accommodate left-turn movements can improve operations and safety while providing flexibility to accommodate varying traffic patterns. Positive offset left-turn lanes can improve sight distance for left-turning movements but may

prohibit U-turns if insufficient width is available. Reversible lanes may be appropriate for arterials that experience heavy directional peaks in traffic volumes during commuter periods.

8. Accommodate decelerating, slow, or stopped vehicles outside higher speed through traffic lanes. Speed differentials between vehicles in the traffic stream are a primary cause of traffic crashes. Speed differentials at intersections are inherent as vehicles decelerate to facilitate a turning maneuver. The provision of exclusive left- and right-turn lanes can improve safety by removing slower moving turning vehicles from the higher speed through traffic stream and reducing potential rear-end conflicts. In addition, through movements will experience lower delay and fewer queues.

9. Provide safe refuge and wayfinding for bicyclists and pedestrians. Intersection design must consider the needs of roadway users other than motorists. Intersection channelization can provide refuge and/or reduce the exposure distance for pedestrians and bicyclists within an intersection without limiting vehicle movement. The use of raised medians, traffic islands, and other pedestrian-friendly treatments should be considered as part of the design process. Wayfinding may also be an issue, particularly at intersections with complicated configurations.

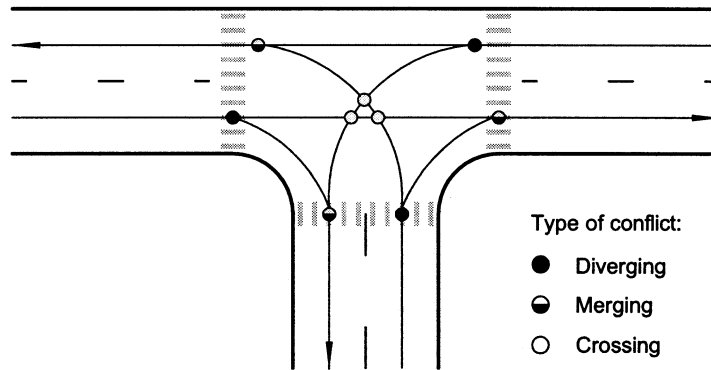
3.2 NUMBER OF INTERSECTION LEGS

While the geometry of various types of intersections may vary, the complexity of an intersection increases with an increasing number of approach legs to the intersections, as shown in figures 16 and 17. The latter shows the number and type of conflicts that occur at intersections with three and four legs, respectively. The number of potential conflicts for all users increases substantially at intersections with more than four legs. Note that many potential conflicts, including crossing and merging conflicts, can be managed (but not eliminated) at a signalized intersection by separating conflicts in time.

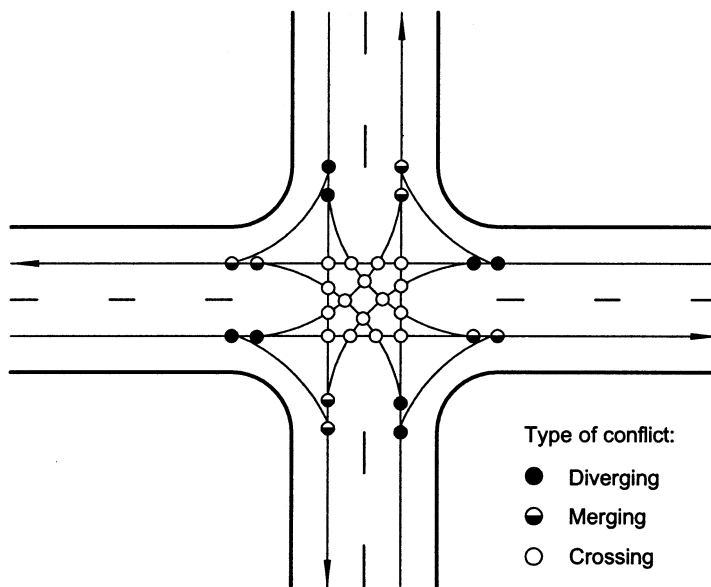


Photograph Credit and Copyright: www.portlandmaps.com, 2004

Figure 16. The photograph illustrates a multileg intersection.



(a) Three-leg intersection.



(b) Four-leg intersection.

Figure 17. Potential conflicts at intersections with three and four legs.

3.3 INTERSECTION ANGLE

The angle of intersection of two roadways can influence both the safety and operational characteristics of an intersection. Heavily skewed intersections not only affect the nature of conflicts, but they produce larger, open pavement areas that can be difficult for drivers to navigate and pedestrians to cross. Such large intersections can also be more costly to build and maintain.

Undesirable operational and safety characteristics of skewed intersections include:

- Difficulty in accommodating large vehicle turns. Additional pavement, channelization, and right-of-way may be required. The increase in pavement area poses potential drainage problems and gives smaller vehicles more opportunity to “wander” from the proper path.

- Vehicles crossing the intersection are more exposed to conflicts. This requires longer clearance intervals and increased lost time, which reduces the capacity of the intersection.
- Pedestrians and bicyclists are exposed to vehicular traffic longer. Longer pedestrian intervals may be required, which may have a negative impact on the intersection's capacity.
- Pedestrians with visual disabilities may have difficulty finding their way to the other side of the street when crossing.
- Driver confusion may result at skewed crossings. Woodson, Tillman, and Tillman found that drivers are more positive in their sense of direction when roadways are at right angles to each other.⁽⁴²⁾ Conversely, drivers become more confused as they traverse curved or angled streets.

Skewed intersections are generally related to right-angle type crashes that can be associated with poor sight distance. AASHTO policy and many State design standards permit skewed intersections of up to 60 degrees.⁽³⁾ Gattis and Low conducted research to identify constraints on the angle of a left-skewed intersection as it is affected by the vehicle body's limiting a driver line-of-sight to the right.⁽⁴³⁾ Their findings suggest that if roadway engineers are to consider the limitations created by vehicle design, a minimum intersection angle of 70 to 75 degrees will offer an improved line of sight. FHWA's *Highway Design Handbook for Older Drivers and Pedestrians* recommends intersection angles of 90 degrees for new intersections where right-of-way is not a constraint, and angles of not less than 75 degrees for new facilities or redesigns of existing facilities where right-of-way is restricted.⁽¹²⁾

3.4 HORIZONTAL AND VERTICAL ALIGNMENT

The approach to a signalized intersection should promote awareness of an intersection by providing the required stopping sight distance in advance of the intersection. This area is critical as the approaching driver or bicyclist begins to focus on the tasks associated with navigating the intersection.

To meet the driver's or cyclist's expectations on approaches to an intersection, the following guidelines are suggested:

- Avoid approach grades to an intersection of greater than 6 percent. On higher design speed facilities (80 km/h (50 mph) and greater), a maximum grade of 3 percent should be considered.
- Avoid locating intersections along a horizontal curve of the intersecting road.
- Strive for an intersection platform (including sidewalks) with cross slope not exceeding 2 percent, as needed for accessibility.

3.5 CORNER RADIUS AND CURB RAMP DESIGN

Intersection corners that are designed appropriately accommodate all users. The selection of corner radius and curb ramp design should be guided by pedestrian crossing and design vehicle needs at the intersection. In general, it is recommended to provide a pedestrian crossing that is as near to perpendicular to the flow of traffic as practical with no intermediate angle points. This keeps pedestrian crossing time and exposure to a minimum, which may allow more efficient operation of the signal. It also aids visually impaired pedestrians in their wayfinding task by eliminating changes in direction that may not be detectable.

Corner radii should also be designed to accommodate the turning path of a design vehicle to avoid encroachment on pedestrian facilities and opposing lanes of travel.

3.5.1 Corner Radius

The corner radii of an intersection should be designed to facilitate the turning and tracking requirements of the selected design vehicle. Other considerations when designing a corner radius include location of traffic control devices (signal poles, controller, signs, etc.), the need to provide channelizing islands, and available right-of-way. The corner radii should be compatible with other intersection features and the speed environment. For example, larger radii are more compatible with high-speed facilities with few pedestrians, whereas smaller radii are more compatible with low-speed facilities with many pedestrians.⁽⁴¹⁾

Factors that influence the selection of appropriate corner radii include the following:

- **Design vehicle.** Selection of a design vehicle should be based on the largest vehicle type that will regularly use an intersection. Often, a design vehicle is mandated by agency policy, regardless of vehicle mix. In certain instances, more than one design vehicle may be appropriate depending on traffic patterns.
- **Angle of intersection.** Large intersection skew angles make turning maneuvers more difficult, particularly for larger vehicles. This has the potential to increase the overall size of the intersection, making drainage difficult and increasing signal clearance intervals to clear the intersection.
- **Pedestrians and bicyclists.** In areas of high pedestrian and bike use, smaller radii are desirable to reduce turning speeds and decrease the distance for pedestrians and bikes to cross the street.
- **Constraints.** Multicentered curves or simple curves with tangent offsets can be used to better match the turn path of the design vehicle and reduce required right-of-way.

3.5.2 Curb Ramp Design

Curb ramps provide access for people who use wheelchairs and scooters. Curb ramps also aid people with strollers, luggage, bicycles, and other wheeled objects in negotiating the intersection. The basic components of a curb ramp, including ramp, landing, detectable warning, flare, and approach, are diagrammed in figure 18. The ADAAG require that curb ramps be provided wherever an accessible route crosses a curb, which includes all designated crosswalks at new and retrofitted signalized intersections.⁽³³⁾ While curb ramps increase access for mobility-impaired pedestrians, they can decrease access for visually impaired pedestrians by removing the vertical curb face that provides an important tactile cue. This tactile cue is instead provided by a detectable warning surface placed at the bottom of the ramp, which provides information on the boundary between the sidewalk and roadway.

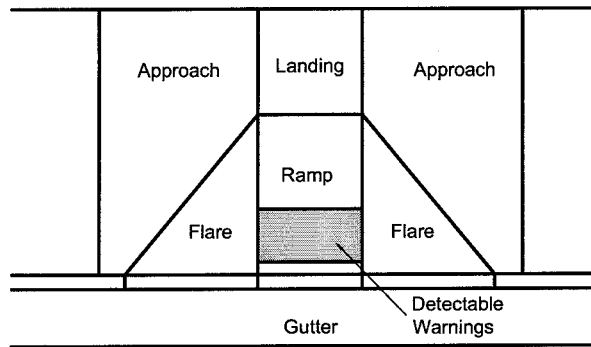


Figure 18. Curb ramp components.

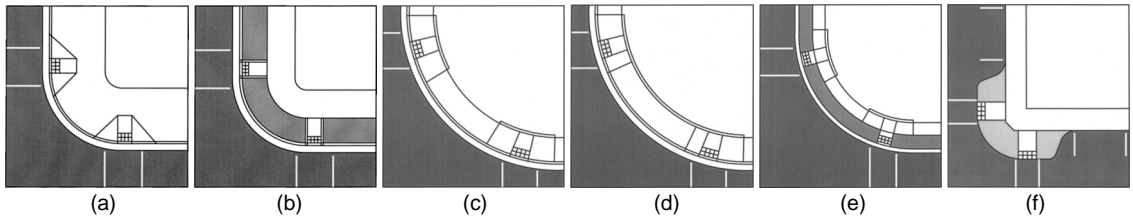
Table 9, adapted from FHWA's *Designing Sidewalks and Trails for Access, Part 2: Best Practices Design Guide*, provides a summary of recommended fundamental practices for curb ramp design, along with the rationale behind each practice.⁽³⁴⁾ A designer can apply these principles in designing intersections in a wide variety of circumstances.

Figures 19-21 provides examples of three categories of typical curb ramp treatments used at signalized intersections: those that should be implemented wherever possible ("preferred designs"), those that meet minimum accessibility requirements but are not as effective as the preferred treatments ("acceptable designs"), and those that are inaccessible and therefore should not be used in new or retrofit designs ("inaccessible designs"). Additional guidance and design details can be found in the source document.⁽³⁴⁾

Table 9. Summary of best practices for curb ramp design and associated rationale.

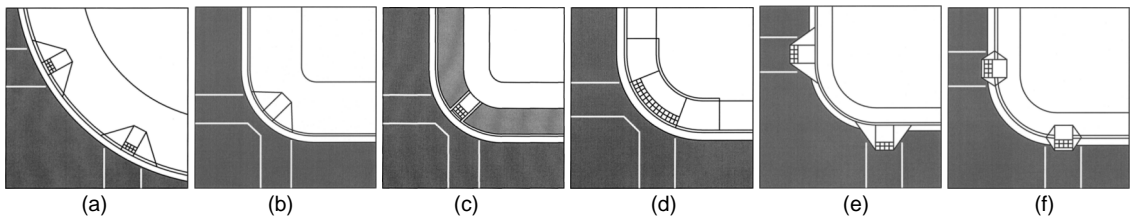
Best Practice	Rationale
Provide a level maneuvering area or landing at the top of the curb ramp.	Landings are critical to allow wheelchair users space to maneuver on or off the ramp. Furthermore, people who are continuing on the sidewalk will not have to negotiate a surface with a changing grade or cross slope.
Clearly identify the boundary between the bottom of the curb ramp and the street with a detectable warning.	Without a detectable warning, people with visual impairments may not be able to identify the boundary between the sidewalk and the street. (Note that detectable warnings are a requirement of ADA as of July 2001.)
Design ramp grades that are perpendicular to the curb.	Assistive devices for mobility are unusable if one side of the device is lower than the other or if the full base of support (e.g., all four wheels on a wheelchair) is not in contact with the surface. This commonly occurs when the bottom of a curb ramp is not perpendicular to the curb.
Place the curb ramp within the marked crosswalk area.	Pedestrians outside of the marked crosswalk are less likely to be seen by drivers because they are not in an expected location.
Avoid changes of grade that exceed 11 percent over a 610 mm (24 inch) interval.	Severe or sudden grade changes may not provide sufficient clearance for the frame of the wheelchair, causing the user to tip forward or backward.
Design the ramp so that it does not require turning or maneuvering on the ramp surface.	Maneuvering on a steep grade can be very hazardous for people with mobility impairments.
Provide a curb ramp grade that can be easily distinguished from surrounding terrain; otherwise, use detectable warnings.	Gradual slopes make it difficult for people with visual impairments to detect the presence of a curb ramp.
Design the ramp with a grade of 7.1 ±1.2 percent. Do not exceed 8.33 percent (1:12).	Shallow grades are difficult for people with vision impairments to detect, but steep grades are difficult for those using assistive devices for mobility.
Design the ramp and gutter with a cross slope of 2.0 percent.	Ramps should have minimal cross slope so users do not have to negotiate a steep grade and cross slope simultaneously.
Provide adequate drainage to prevent the accumulation of water or debris on or at the bottom of the ramp.	Water, ice, or debris accumulation will decrease the slip resistance of the curb ramp surface.
Provide transitions from ramps to gutter and streets that are flush and free of level changes.	Maneuvering over any vertical rise such as lips and defects can cause wheelchair users to propel forward when wheels hit this barrier.
Align the curb ramp with the crosswalk so there is a straight path of travel from the top of the ramp to the center of the roadway to the curb ramp on the other side.	Where curb ramps can be seen in advance, people using wheelchairs often build up momentum in the crosswalk in order to get up the curb ramp grade (i.e., they "take a run at it"). This alignment may be useful for people with vision impairments.
Provide clearly defined and easily identified edges or transitions on both sides of the ramp to contrast with the sidewalk.	Clearly defined edges assist users with vision impairments to identify the presence of the ramp when it is approached from the side.

Source: Adapted from reference 34, table 7-1.



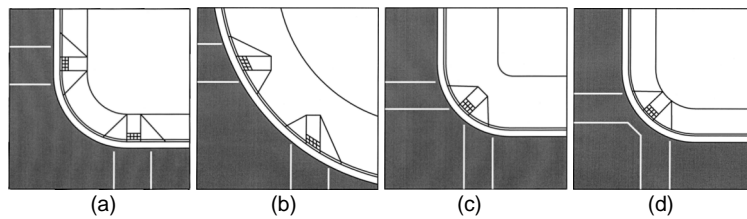
- a. Perpendicular curb ramps with flares and a level landing.
- b. Perpendicular curb ramps with returned curbs and a level landing.
- c. Two parallel curb ramps on a wide turning radius.
- d. Two parallel curb ramps with a lowered curb.
- e. Two combination curb ramps on a corner with a wide turning radius.
- f. A curb extension with two perpendicular curb ramps with returned curbs and level landings.

Figure 19. Examples of preferred designs.



- a. Perpendicular curb ramps, oriented perpendicular to the curb, on a corner with a wide turning radius.
- b. Diagonal curb ramp with flares and a level landing, in addition to at least 1.22 m (48 inch) of clear space.
- c. Diagonal curb ramp with returned curbs, a level landing, and sufficient clear space in the crosswalk.
- d. Single parallel curb ramp with at least 1.22 m (48 inch) clear space.
- e. Two built-up curb ramps.
- f. Partially built-up curb ramps.

Figure 20. Examples of acceptable curb ramp designs.



- a. Perpendicular curb ramps without a landing.
- b. On a corner with a wide turning radius, curb ramps are aligned parallel with the crosswalk.
- c. Diagonal curb ramp with no clear space or no level area at the bottom of the curb ramp.
- d. Diagonal curb ramps without a level landing.

Figure 21. Examples of inaccessible designs.

Source: Reproduced from reference 34, table 7-2

3.5.3 Detectable Warnings

The ADAAG require that a detectable warning surface be applied to the surface of the curb ramps and within the refuge of any medians and islands (defined in the ADAAG as “hazardous vehicle areas”) to provide tactile cues to individuals with visual impairments.⁽³³⁾ Detectable warnings consist of a surface of truncated domes built in or applied to walking surfaces; the domes provide a distinctive surface detectable by cane or underfoot. This surface alerts visually impaired pedestrians of the presence of the vehicular travel way, and provides physical cues to assist pedestrians in detecting the boundary from sidewalk to street where curb ramps and blended transitions are devoid of other tactile cues typically provided by a curb face.

At the face of a curb ramp and within the refuge area of any median island, a detectable warning surface should be applied as shown in figure 22. The detectable warning surface begins at the curb line and extends into the ramp or pedestrian refuge area a distance of 610 mm (24 inches). For a median island, this creates a minimum clear space of 610 mm (24 inches) between the detectable warning surfaces for a minimum median island width of 1.8 m (6 ft) at the pedestrian crossing. This is a deviation from the requirements of the ADAAG (§4.29.5), which requires a surface width of 915 mm (36 inches). However, this deviation is necessary to enable visually impaired pedestrians to distinguish where the refuge begins and ends from the adjacent roadway where the minimum 1.8 m (6 ft) refuge width is provided.

Table 10 summarizes ADAAG requirements for detectable warning surfaces.



Photograph Credit: Lee Rodegerdts, 2003

Figure 22. This crosswalk design incorporates the use of detectable warning surfaces into the curb ramps to facilitate navigation by a visually impaired pedestrian.

Table 10. Requirements for detectable warning surfaces.

Legislation	<i>Americans with Disabilities Act Accessibility Guidelines</i> ⁽³³⁾	<i>Draft Guidelines on Accessible Public Rights-of-Way</i> ⁽⁴⁴⁾
Applicability	Required under existing regulations.	These guidelines are in the rulemaking process and are therefore not enforceable. They will be incorporated into the ADAAG; however, the recommendations listed below are subject to revision prior to the issuance of a final rule.
Type	Raised truncated domes.	Raised truncated domes aligned in a square grid pattern.
Dome Size	Nominal diameter: 23 mm (0.9 inches). Nominal height: 5 mm (0.2 inches).	Base diameter: 23 mm (0.9 inches) minimum, 36 mm (1.4 inches) maximum. Ratio of top diameter to base diameter: 50% minimum, 65% maximum. Height: 5 mm (0.2 inches).
Dome Spacing	Nominal center-to-center spacing: 60 mm (2.35 inches).	Center-to-center spacing: 41 mm (1.6 inches) minimum, 61 mm (2.4 inches) maximum. Base-to-base spacing: 16 mm (0.65 inches) minimum, measured between the most adjacent domes on square grid.
Contrast	Detectable warning surfaces must contrast visually with adjacent walking surfaces either light-on-dark, or dark-on-light. The material used to provide contrast must be an integral part of the walking surface.	Detectable warning surfaces must contrast visually with adjacent walking surfaces either light-on-dark, or dark-on-light.
Size	At curb ramps: The detectable warning must extend the full width and depth of the curb ramp. Within median islands, the boundary between the curbs must be defined by a continuous detectable warning 915 mm (36 inches) wide, beginning at the curb line.	At curb ramps, landings, or blended transitions connecting to a crosswalk: Detectable warning surfaces must extend 610 mm (24 inches) minimum in the direction of travel and the full width of the curb ramp, landing, or blended transition. The detectable warning surface must be located so that the edge nearest the curb line is 150 mm (6 inches) minimum and 205 mm (8 inches) maximum from the curb line. Within median islands, the detectable warning surface must begin at the curb line and extend into the pedestrian refuge a minimum of 610 mm (24 inches). Detectable warnings must be separated by a minimum length of walkway of 610 mm (24 inches) without detectable warnings.

The *Draft Guidelines on Accessible Public Rights-of-Way*, developed by the U.S. Access Board, issued a similar recommendation for use of a 610-mm (24-inch) width for detectable warning surfaces.⁽⁴⁴⁾ This is consistent with the existing ADAAG requirements for truncated dome detectable warning surfaces at transit platforms. The draft public right-of-way guidelines are based upon the recommendations of the Public Rights of Way Access Advisory Committee as published in the report *Building a True Community*.⁽⁴⁵⁾ For detectable warning surfaces, both the U.S. Access Board and FHWA are encouraging the use of the new (recommended) design pattern and application over the original ADAAG requirements.⁽³³⁾

3.6 SIGHT DISTANCE

A driver's ability to see the road ahead and other intersection users is critical to safe and efficient use of all roadway facilities, especially signalized intersections. Stopping sight distance, decision sight distance, and intersection sight distance are particularly important at signalized intersections.

3.6.1 Stopping Sight Distance

Stopping sight distance is the distance along a roadway required for a driver to perceive and react to an object in the roadway and to brake to a complete stop before reaching that object. Stopping sight distance should be provided throughout the intersection and on each entering and exiting approach. Table 11 gives recommended stopping sight distances for design, as computed from the equations provided in the AASHTO policy.⁽³⁾

Table 11. Design values for stopping sight distance.

Speed (km/h)	Computed Distance* (m)	Design Distance (m)	Speed (mph)	Computed Distance* (ft)	Design Distance (ft)
20	18.5	20	15	76.7	80
30	31.2	35	20	111.9	115
40	46.2	50	25	151.9	155
50	63.5	65	30	196.7	200
60	83.0	85	35	246.2	250
70	104.9	105	40	300.6	305
80	129.0	130	45	359.8	360
90	155.5	160	50	423.8	425
100	184.2	185	55	492.4	495
110	215.3	220	60	566.0	570
120	248.6	250	65	644.4	645

* Assumes 2.5 s perception-braking time, 3.4 m/s² (11.2 ft/s²) driver deceleration
Source: Reference 3, exhibit 3-1.

Stopping sight distance should be measured using an assumed height of driver's eye of 1,080 mm (3.5 ft) and an assumed height of object of 600 mm (2.0 ft).⁽³⁾

3.6.2 Decision Sight Distance

Decision sight distance is "the distance needed for a driver to detect an unexpected or otherwise difficult-to-perceive information source or condition in a roadway environment that may be visually cluttered, recognize the condition or its potential threat, select an appropriate speed and path, and initiate and complete the maneuver safely and efficiently."^(3, p. 115) Decision sight distance at intersections is applicable for situations where vehicles must maneuver into a particular lane in advance of the intersection (e.g., alternative intersection designs using indirect left turns).

Decision sight distance varies depending on whether the driver is to come to a complete stop or make some kind of speed, path, or direction change. Decision sight distance also varies depending on the environment—urban, suburban, or rural. Table 12 gives recommended values for decision sight distance, as computed from equations in the AASHTO policy.⁽³⁾

Table 12. Design values for decision sight distance for selected avoidance maneuvers.

Speed (km/h)	Metric (m)					Speed (mph)	U.S. Customary (ft)				
	A	B	C	D	E		A	B	C	D	E
50	70	155	145	170	195	30	220	490	450	535	620
60	95	195	170	205	235	35	275	590	525	625	720
70	115	235	200	235	275	40	330	690	600	715	825
80	140	280	230	270	315	45	395	800	675	800	930
90	170	325	270	315	360	50	465	910	750	890	1030
100	200	370	315	355	400	55	535	1030	865	980	1135
110	235	420	330	380	430	60	610	1150	990	1125	1280
120	265	470	360	415	470	65	695	1275	1050	1220	1365

Avoidance Maneuver A: Stop on rural road, time (t) = 3.0 s.

Avoidance Maneuver B: Stop on urban road, t = 9.1 s.

Avoidance Maneuver C: Speed/path/direction change on rural road, t = 10.2 s to 11.2 s.

Avoidance Maneuver D: Speed/path/direction change on suburban road, t = 12.1 s to 12.9 s.

Avoidance Maneuver E: Speed/path/direction change on urban road, t = 14.0 s to 14.5 s.

Source: Reference 3, exhibit 3-3.

3.6.3 Intersection Sight Distance

Intersection sight distance is the distance required for a driver without the right of way to perceive and react to the presence of conflicting vehicles and pedestrians.

Intersection sight distance is traditionally measured through the determination of a sight triangle. This triangle is bounded by a length of roadway defining a limit away from the intersection on each of the two conflicting approaches and by a line connecting those two limits. Intersection sight distance should be measured using an assumed height of driver's eye of 1,080 mm (3.5 ft) and an assumed height of object of 1,080 mm (3.5 ft).⁽³⁾ The area within the triangle is referred to as the clear zone and should remain free from obstacles.

The reader is encouraged to refer to the AASHTO policy, pp. 654-680, for a complete discussion of intersection sight distance requirements.⁽³⁾ Intersection sight distance at signalized intersections is generally simpler than for stop-controlled intersections. The following criteria should be met:

- The first vehicle stopped on an approach should be visible to the first driver stopped on each of the other approaches.
- Vehicles making permissive movements (e.g., permissive left turns, right turns on red, etc.) should have sufficient sight distance to select gaps in oncoming traffic.
- Permissive left turns should satisfy the case for left turns from the major road (Case F, reference 3).
- Right turns on red should satisfy the case for a stop-controlled right turn from the minor road (Case B2, reference 3).

For signalized intersections where two-way flashing operation is planned (i.e., flashing yellow on the major street and flashing red on the minor street), departure sight triangles for Case B should be provided for the minor-street approaches.⁽³⁾

3.7 PEDESTRIAN FACILITIES

Pedestrian facilities should be provided at all intersections in urban and suburban areas. In general, design of the pedestrian facilities of an intersection with the most challenged users in mind—pedestrians with mobility or visual impairments—should be done. The resulting design will serve all pedestrians well. In addition, the ADA requires that new and altered facilities constructed

by, on behalf of, or for the use of State and local government entities be designed and constructed to be readily accessible to and usable by individuals with disabilities.⁽³³⁾ Therefore, it is not only good practice to design for all pedestrian types, but it is also a legal requirement.

Pedestrians are faced with a number of disincentives to walking, including centers and services located far apart, physical barriers and interruptions along pedestrian routes, a perception that routes are unsafe due to motor vehicle conflicts and crime, and routes that are esthetically unpleasing.⁽⁴⁶⁾

Key elements that affect a pedestrian facility that practitioners should incorporate into their design are listed below:⁽⁴⁷⁾

- Keep corners free of obstructions to provide enough room for pedestrians waiting to cross.
- Maintain adequate lines of sight between drivers and pedestrians on the intersection corner and in the crosswalk.
- Ensure curb ramps, transit stops (where applicable), pushbuttons, etc. are easily accessible and meet ADAAG design standards.
- Clearly indicate the actions pedestrians are expected to take at crossing locations.
- Design corner radii to ensure vehicles do not drive over the pedestrian area yet are able to maintain appropriate turning speeds.
- Ensure crosswalks clearly indicate where crossings should occur and are in desirable locations.
- Provide appropriate intervals for crossings and minimize wait time.
- Limit exposure to conflicting traffic, and provide refuges where necessary.
- Ensure the crosswalk is a direct continuation of the pedestrian's travel path.
- Ensure the crossing is free of barriers, obstacles, and hazards.

3.8 BICYCLE FACILITIES

Some intersections have on-street bicycle lanes or off-street bicycle paths entering the intersection. When this occurs, intersection design should accommodate the needs of cyclists in safely navigating such a large and often complicated intersection. Some geometric features that should be considered include:

- Bike lanes and bike lane transitions between through lanes and right turn lanes.
- Left turn bike lanes.
- Median refuges with a width to accommodate a bicycle: 2.0 m (6 ft) = poor; 2.5 m (8 ft) = satisfactory; 3.0 m (10 ft) = good.^(21, p. 52)
- Separate facilities if no safe routes can be provided through the intersection itself.

The interaction between motor vehicles and bicyclists at interchanges with merge and diverge areas is especially complex, and some signalized intersections also have merge and diverge areas due to free right turns or diverted movements (see chapter 10). AASHTO recommends that “[i]f a bike lane or route must traverse an interchange area, these intersection or conflict points should be designed to limit the conflict areas or to eliminate unnecessary uncontrolled ramp connections to urban roadways.”^(21, p. 62)

CHAPTER 4

TRAFFIC DESIGN AND ILLUMINATION

TABLE OF CONTENTS

4.0	TRAFFIC DESIGN AND ILLUMINATION	59
4.1	Traffic Signal Control Type	59
4.2	Traffic Signal Phasing	59
4.2.1	“Permissive-Only” Left-Turn Phasing	60
4.2.2	“Protected-Only” Left-Turn Phasing	62
4.2.3	Protected-Permissive Left-Turn Phasing	63
4.2.4	Split Phasing	67
4.2.5	Prohibited Left-Turn Phasing	70
4.2.6	Right-Turn Phasing	70
4.3	Vehicle and Pedestrian Displays	72
4.3.1	Vehicle Displays	72
4.3.2	Pedestrian Displays	76
4.4	Traffic Signal Pole Layout	77
4.5	Traffic Signal Controller	78
4.6	Detection Devices	79
4.6.1	Vehicle Detection	79
4.6.2	Pedestrian Detection	83
4.7	Basic Signal Timing Parameters	83
4.7.1	Pedestrian Timing	84
4.7.2	Vehicle Timing—Green Interval	84
4.7.3	Vehicle Timing—Detector Timing	85
4.7.4	Vehicle Timing—Vehicle Clearance	85
4.7.5	Vehicle Timing—Cycle Length	86
4.8	Signing and Pavement Marking Design	86
4.9	Illumination Design	90
4.9.1	Illuminance	91
4.9.2	Veiling Illuminance	92

LIST OF FIGURES

<u>Figure</u>		<u>Page</u>
23	Standard NEMA ring-and-barrier structure	60
24	Typical phasing diagram for “permissive-only” left-turn phasing	61
25	Possible signal head arrangements for “permissive-only” left-turn phasing	62
26	Typical phasing diagram for “protected-only” left-turn phasing	63
27	Possible signal head arrangements for “protected-only” left-turn phasing	63
28	Typical phasing diagram for protected-permissive left-turn phasing	64
29	Possible signal head and signing arrangement for protected-permissive left-turn phasing	64
30	Illustration of the yellow trap	66
31	The protected-permissive left-turn display known as “Dallas display” uses louvers to restrict visibility of the left-turn display to adjacent lanes	67
32	Typical phasing diagrams for split phasing	69
33	Common signal head arrangement for split phasing	70
34	Typical phasing diagram illustrating a right-turn overlap	71
35	Common signal head and signing arrangement for right-turn-overlap phasing	72
36	Examples showing five optional signal head locations	74

CHAPTER 4 FIGURES, CONTINUED

<u>Figure</u>	<u>Page</u>
37 Pedestrian signal indicators.....	76
38 Example of advance street name sign for upcoming intersection.....	87
39 Example of advance street name sign for two closely spaced intersections	88
40 Example of signing for a left-hand land trap	88
41 Example of advance overhead signs indicating lane use for various destinations	89
42 Example of pavement legends indicating destination route numbers ("horizontal signage").....	90

LIST OF TABLES

<u>Table</u>	<u>Page</u>
13 Advantages and disadvantages of various configurations for displaying vehicle signal indications.....	77
14 Traffic signal controller advantages and disadvantages.....	79
15 Strengths and weaknesses of commercially available detector technologies.....	81
16 Location of advanced vehicle detectors	83
17 Recommended illuminance for the intersection of continuously lighted urban streets.....	92
18 RP-8-00 guidance for roadway and pedestrian/area classification for purposes of determining intersection illumination levels	93

4. TRAFFIC DESIGN AND ILLUMINATION

This chapter deals with the traffic signal hardware and software—the infrastructure that controls the assignment of vehicular and pedestrian right-of-way at locations where conflicts or hazardous conditions exist. The proper application and design of the traffic signal is a key component in improving the safety and efficiency of the intersection.

This chapter presents an overview of the fundamental principles of traffic design and illumination as they apply to signalized intersections. The topics discussed include:

- Traffic signal control types.
- Traffic signal phasing.
- Vehicle and pedestrian detection.
- Traffic signal pole layout.
- Traffic signal controllers.
- Basic signal timing parameters.
- Signing and pavement marking.
- Illumination.

4.1 TRAFFIC SIGNAL CONTROL TYPE

Traffic signals operate in either pre-timed or actuated mode. Pre-timed signals operate with fixed cycle lengths and green splits. Actuated signals vary the amount of green time allocated to each phase based on traffic demand. Either type may be used in isolated (independent) or coordinated operation. Most pre-timed controls feature multiple timing plans, with different cycle, split, and offset values for different periods of the day.

Actuated control does not rely on a fixed cycle length unless the intersection is in a coordinated system or under adaptive control. Actuated control provides variable lengths of green timing for phases that are equipped with detectors. The time for each movement depends on the characteristics of the intersection and timing parameters (which are based on demand at the intersection).

4.2 TRAFFIC SIGNAL PHASING

The MUTCD defines a signal phase as the right-of-way, yellow change, and red clearance intervals in a cycle that are assigned to an independent traffic movement or combination of traffic movements.⁽¹⁾ Signal phasing is the sequence of individual signal phases or combinations of signal phases within a cycle that define the order in which various pedestrian and vehicular movements are assigned the right-of-way. The MUTCD provides rules for determining controller phasing, selecting allowable signal indication combinations for displays on an approach to a traffic control signal, and determining the order in which signal indications can be displayed.

Signal phasing at most intersections in the United States makes use of a standard National Electrical Manufacturers Association (NEMA) ring-and-barrier structure, shown in figure 23. This structure organizes phases to prohibit conflicting movements (e.g., eastbound and southbound through movements) from timing concurrently while allowing nonconflicting movements (e.g., northbound and southbound through movements) to time together. Most signal phasing patterns in use in the United States can be achieved through the selective assignment of phases to the standard NEMA ring-and-barrier structure.

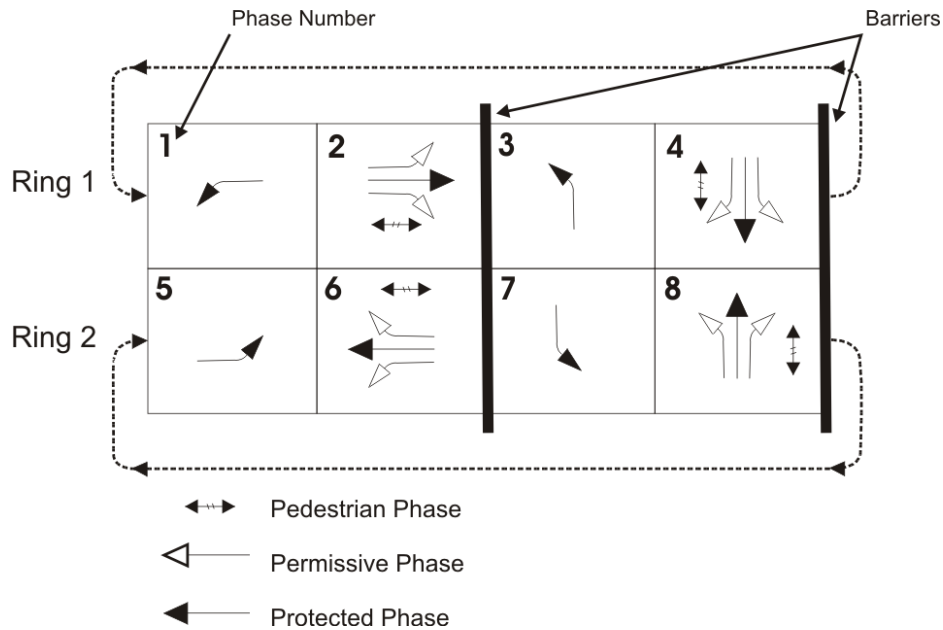


Figure 23. Standard NEMA ring-and-barrier structure.

Depending on the complexity of the intersection, 2 to 8 phases are typically used, although some controllers can provide up to 40 phases to serve complex intersections or sets of intersections. Pedestrian movements are typically assigned to parallel vehicle movements.

Developing an appropriate phasing plan begins with determining the left-turn phase type at the intersection. The most basic form of control for a four-legged intersection is “permissive only” control, which allows drivers to make left turns after yielding to conflicting traffic or pedestrians and provides no special protected interval for left turns. As a general rule, the number of phases should be kept to a minimum because each additional phase in the signal cycle reduces the time available to other phases.

Provision of a separate left-turn lane may alleviate the problems somewhat by providing storage space where vehicles can await an adequate gap without blocking other traffic movements at the intersection. In most cases, the development of a signal phasing plan should involve an analytical analysis of the intersection. Several software packages are suitable for selecting an optimal phasing plan for a given set of geometric and traffic conditions for both individual intersections and for system optimization.

Pedestrian movements must be considered during the development of a phasing plan. For example, on wide roadways pedestrian timing may require timing longer than what is required for vehicular traffic, which may have an effect on the operation analysis.

4.2.1 “Permissive-Only” Left-Turn Phasing

“Permissive-only” (also known as “permitted-only”) phasing allows two opposing approaches to time concurrently, with left turns allowed after yielding to conflicting traffic and pedestrians. One possible implementation of this phasing pattern is illustrated in figure 24. Note that the two opposing movements could be run in concurrent phases using two rings; for example, the eastbound and westbound through movements shown in figure 24 could be assigned as phase 2 and phase 6, respectively.

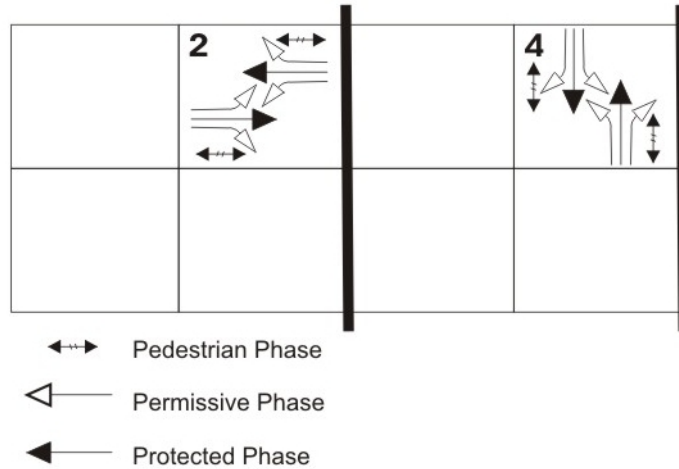
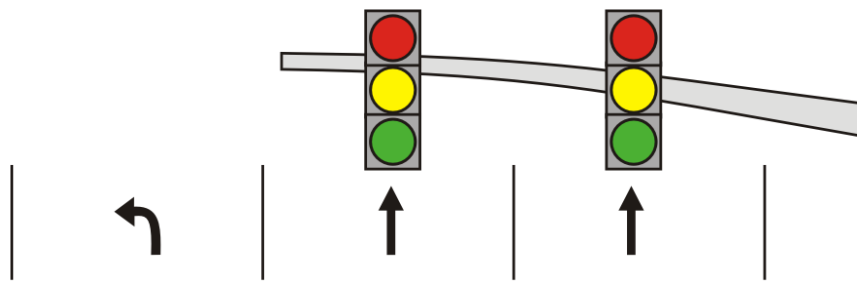


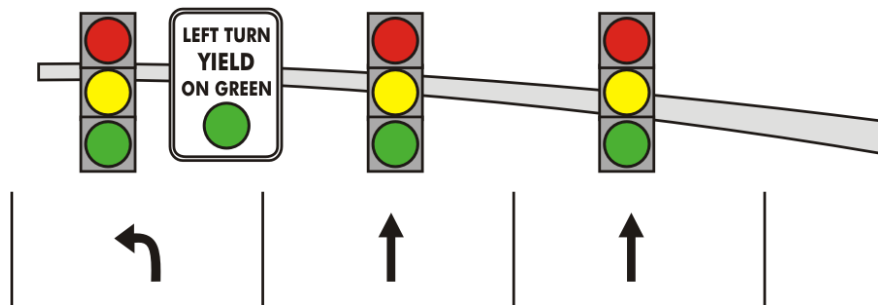
Figure 24. Typical phasing diagram for “permissive-only” left-turn phasing.

For most high-volume intersections, “permissive-only” left-turn phasing is generally not practical for major street movements given the high volume of the intersections. Minor side street movements, however, may function acceptably using “permissive-only” left-turn phasing, provided that traffic volumes are low enough to operate adequately and safely without additional left-turn protection.

“Permissive-only” displays are signified by a green ball indication. In this case, no regulatory sign is required, but the MUTCD (sections 2B.45 and 4D.06) allows the option of using the R10-12 regulatory sign (“LEFT TURN YIELD ON GREEN (symbolic green ball)”).⁽¹⁾ As traffic volumes increase at the intersection, the number of adequate gaps to accommodate left-turning vehicles on the permissive indication may result in safety concerns at the intersection. Common signal head arrangements that implement “permissive only” phasing are shown in figure 25; refer to the MUTCD for other configurations.



(a) Permissive left-turn phasing using three-section signal heads over the through lanes only.



(b) Permissive left-turn phasing using three-section signal heads over the through lanes and a three-section signal head and accompanying sign over the left turn lane.

Figure 25. Possible signal head arrangements for “permissive-only” left-turn phasing.

4.2.2 “Protected-Only” Left-Turn Phasing

“Protected-only” phasing consists of providing a separate phase for left-turning traffic and allowing left turns to be made only on a green left arrow signal indication, with no pedestrian movement or vehicular traffic conflicting with the left turn. As a result, left-turn movements with “protected-only” phasing have a higher capacity than those with “permissive-only” phasing due to fewer conflicts. This phasing pattern is illustrated in figure 26. Typical signal head and associated signing arrangements that implement “protected-only” phasing are shown in figure 27; refer to the MUTCD for other configurations. Chapter 12 of this document provides guidance on determining the need for protected left turns.

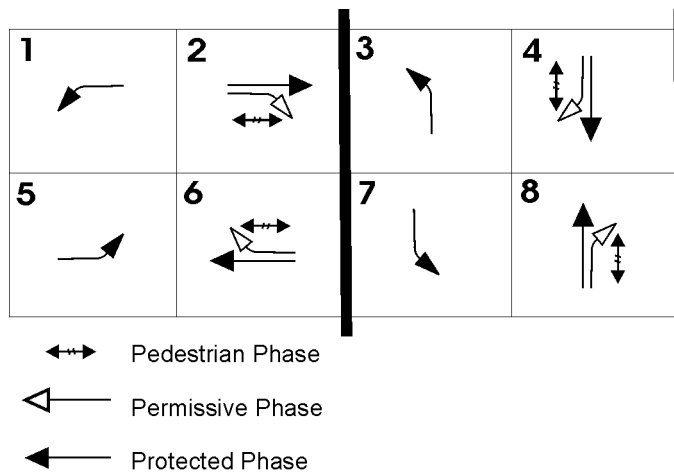
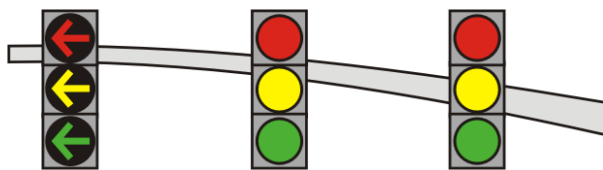
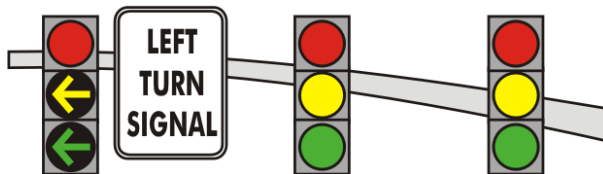


Figure 26. Typical phasing diagram for “protected-only” left-turn phasing.



(a) Protected left-turn phasing using a three-section signal head with red, yellow, and green arrows.



(b) Protected left-turn phasing using a three-section signal head with red ball, yellow arrow, and green arrow and an accompanying sign.

Figure 27. Possible signal head arrangements for “protected-only” left-turn phasing.

4.2.3 Protected-Permissive Left-Turn Phasing

A combination of protected and permissive left-turn phasing is referred to as protected-permissive left-turn (PPLT) operation. This phasing pattern is illustrated in figure 28. A typical signal head and associated signing arrangement that implements protected-permissive phasing is shown in figure 29; refer to the MUTCD for other configurations.

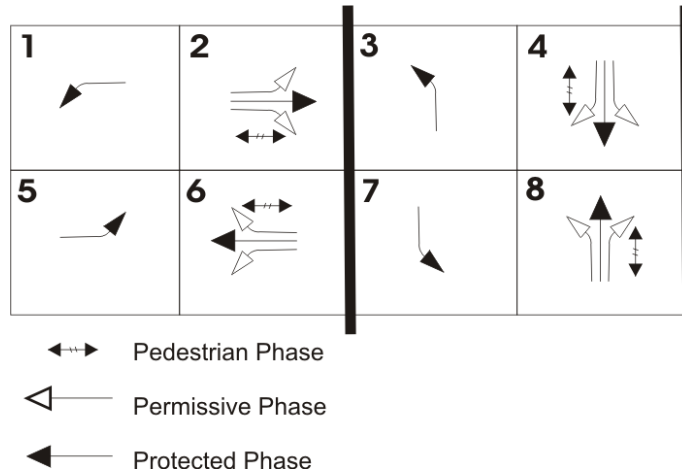
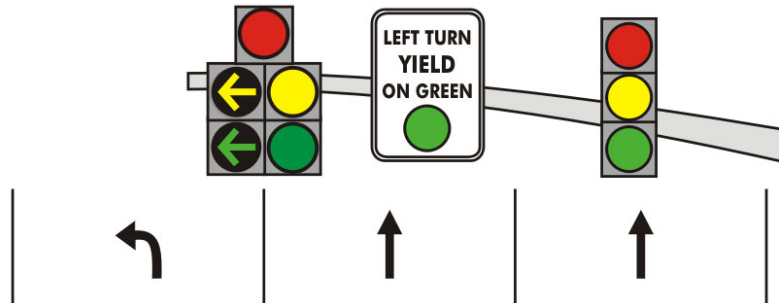
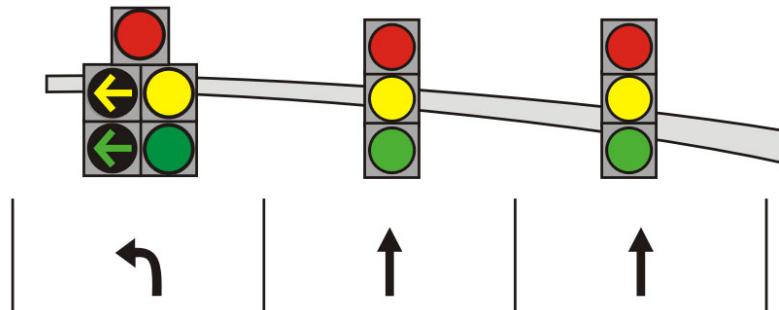


Figure 28. Typical phasing diagram for protected-permissive left-turn phasing.



(a) Protected-permissive left-turn phasing using a five-section head located directly above the lane line that separates the exclusive through and exclusive left-turn lane, along with an accompanying sign.



(b) Protected-permissive left-turn phasing using a five-section signal head located directly above the exclusive left-turn lane.

Figure 29. Possible signal head and signing arrangement for protected-permissive left-turn phasing.

Observed improvements in signal progression and efficiency combined with driver acceptance have led to expanded usage of PPLT over the years. PPLT signals offer numerous advantages when compared to “protected-only” operation. These advantages are associated with

both protected-permissive and lead-lag operation. They include the following (adapted with additions by the authors).⁽⁴⁸⁾

- Average delay per left-turn vehicle is reduced.
- Protected green arrow time is reduced.
- There is potential to omit a protected left-turn phase.
- Arterial progression can be improved, particularly when special signal head treatments are used to allow lead-lag phasing.

Some disadvantages include the following:

- The permissive phase increases the potential for vehicle-vehicle and vehicle-pedestrian conflicts.
- There is a limited ability to use lead-lag phase sequences unless special signal head treatments are used (see below).

The controller phasing for protected-permissive mode is the most complicated phasing because of the safety implications created by the potential of what is known as the “yellow trap.” In a permissive-mode operation, the left-turning driver must obey the green display for the adjacent through movement, which also gives permission for the permissive left turn. When the yellow display for the adjacent through movement appears, the left-turning driver ordinarily expects the opposing through display to be yellow as well. The driver may now mistakenly believe that the left turn can be completed on the yellow display or immediately thereafter when the opposing through display will be red.

For ordinary lead-lead operation where both protected left-turn phases precede the permissive phases, this is not a concern, as both permissive phases end concurrently. However, this problem can occur when a permissive left turn is opposed by a lagging protected left turn. In this type of operation (known as lag-permissive), the yellow display seen by a left-turning driver is not indicative of the display seen by the opposing through driver. The opposing through display may be yellow or may remain green. A driver who turns left believing that the opposing driver has a yellow or red display when the opposing driver has a green display may be making an unsafe movement. This yellow trap is illustrated in figure 30.

Drivers who encounter this trap are those that attempt to make a permissive left-turn after a protected leading left-turn phase. Typically they have entered the intersection on a permissive green waiting to make a left turn when sufficient gaps occur in opposing through traffic. If the absence of gaps in opposing through traffic requires them to make their turn during the left-turn clearance interval, they may be “stranded” in the intersection because of the absence of gaps and because the opposing through movement remains green. More importantly, they may incorrectly presume that the opposing through traffic is being cleared at the same time that the adjacent through movement is being terminated. Therefore, they may complete their turn believing that opposing vehicles are slowing to a stop when in fact the opposing vehicles are proceeding into the intersection with a green ball signal indication.

There are two ways to eliminate the yellow trap. First, the phase sequence at the intersection can be restricted to simultaneous leading (lead-lead) or lagging (lag-lag) left-turn phasing. Second, the signal display can be altered to allow the left-turn signal head to display a permissive left turn independently of the adjacent through movements, which allows the through movements to terminate but allow a permissive left turn to continue during the opposite approach’s lagging protected left-turn phase. Some agencies have experimented with signal displays (e.g., “Dallas Display,” flashing circular red, flashing red arrow, flashing circular yellow, and flashing yellow arrow) that allow this type of operation. Of these, the “Dallas Display” optically restricts the visibility of the permissive movement using louvers; it is fully compliant with the MUTCD and is shown in figure 31.

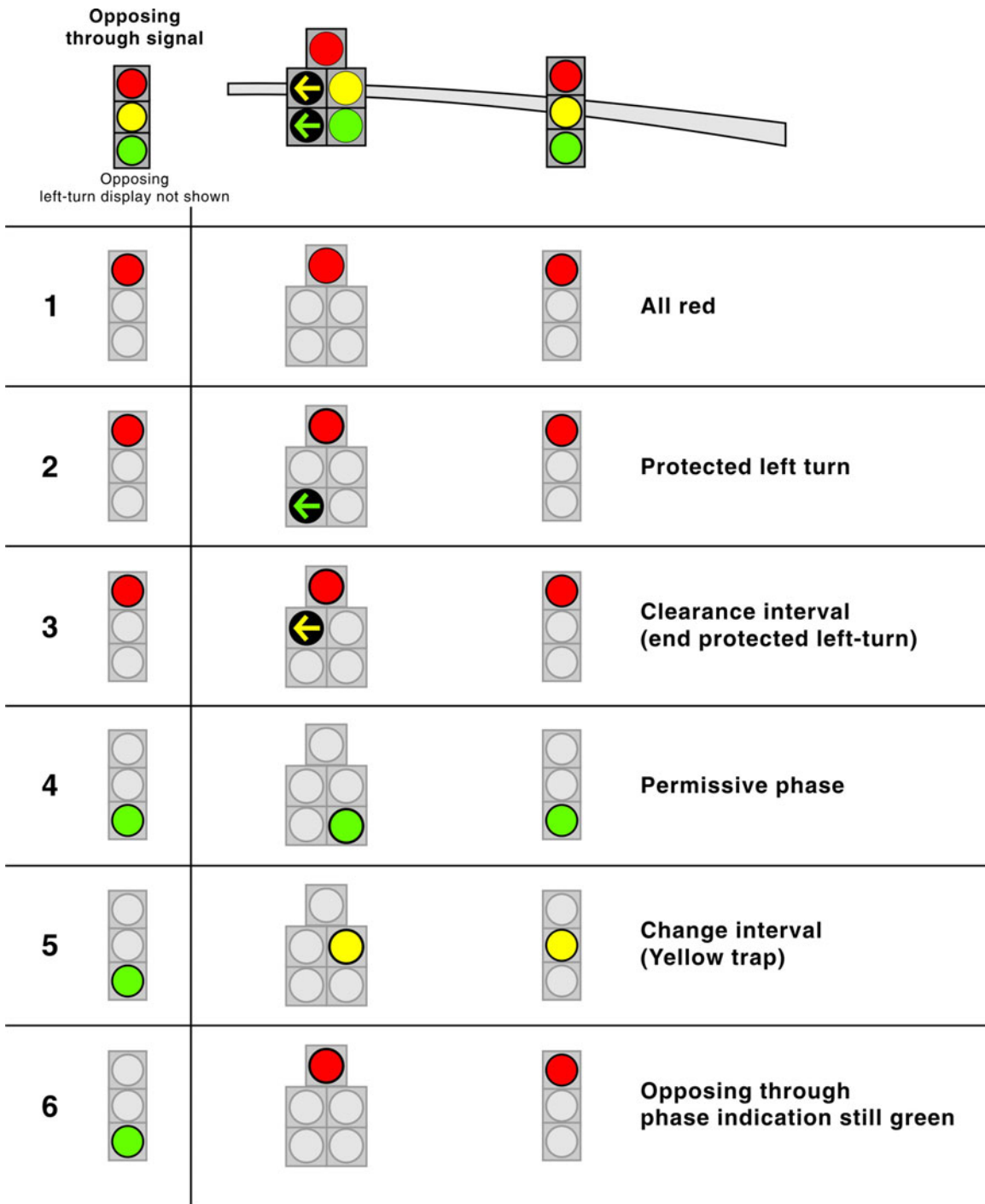


Figure 30. Illustration of the yellow trap.⁽³⁾

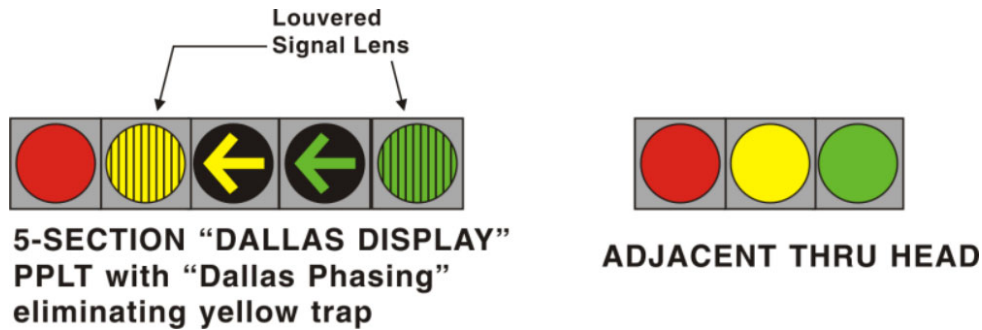


Figure 31. The protected-permissive left-turn display known as "Dallas display" uses louvers to restrict visibility of the left-turn display to adjacent lanes.⁽⁴⁹⁾

A national NCHRP study, has examined the operational advantages and safety aspects of various PPLT control devices and signal arrangements. The study determined that a flashing yellow arrow PPLT display was consistently found to be equal or superior to existing PPLT displays both in a laboratory environment and in cities where the display was experimentally implemented in the field.⁽⁴⁹⁾ The flashing yellow arrow display for PPLT is still considered experimental by the MUTCD and is undergoing further field testing.

4.2.4 Split Phasing

Split phasing consists of having two opposing approaches time consecutively rather than concurrently (i.e., all movements originating from the west followed by all movements from the east). Split phase can be implemented in a variety of ways depending on signal controller capabilities and how pedestrian movements are treated. Three basic variations, shown in figure 32, are described as follows:

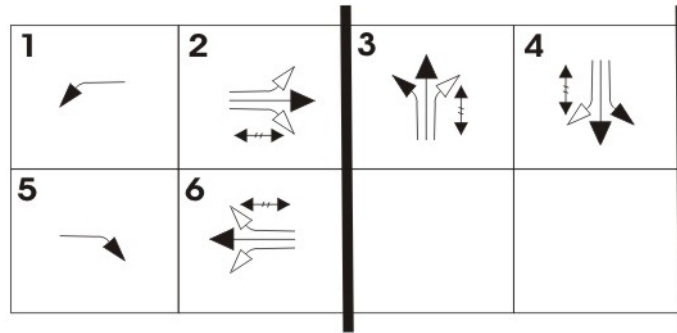
- **Method A: Consecutive pedestrian phases using one ring.** This method associates each pedestrian phase with its adjacent vehicle phase. This places pedestrians at potential conflict with right-turning traffic only. However, this may result in potentially consecutive pedestrian phases if pedestrian calls are present on both phases. For large intersections, the minimum time needed to serve these consecutive movements may result in excessively long cycle lengths. Implementation uses two consecutive phases in the same ring (e.g., phases 3 and 4), with pedestrian phases assigned to each.
- **Method B: Consecutive pedestrian phases using "exclusive" settings in controller.** This method is functionally identical to method A. Implementation differs from method A in that a setting in the controller is needed to force the phases to time in an "exclusive" mode (e.g., the phase must not time with any other phases).
- **Method C: Concurrent pedestrian phases using two rings.** This method, used by some agencies in certain situations, associates pedestrian movements with a single phase in one ring that, when actuated, operates concurrently with two consecutively timing vehicle phases in the second ring. Details of implementation of this method can be found in Wainwright.⁽⁵⁰⁾ This method can provide a considerably more efficient operation of the intersection, particularly where pedestrian crossing demands are large enough to warrant pedestrian signals but are relatively infrequent (not every cycle) during most or all of the day. In most cycles, no pedestrian actuation occurs, so:
 - The split vehicular phases operate without any pedestrian timing considerations.

- The sequential vehicular phase green times are directly related to their respective vehicular demands.
- The green left arrow signal indication is displayed to each of the sequential vehicle phases to encourage efficient nonyielding movement.

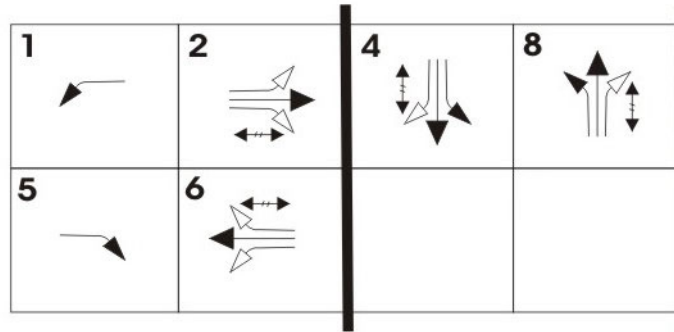
Method C is advantageous under some conditions, but should not be applied indiscriminately because it does have some potential liabilities as compared to the other two methods. Firstly, during the cycles when the pedestrian phase is actuated, left-turning vehicles can sometimes be placed in an awkward situation of not being able to clear the intersection when the vehicle phase terminates because conflicting pedestrians have not yet finished crossing. Secondly, pedestrians could face both left-turning and right-turning conflicting vehicles. Thirdly, if for some reason the timing parameters for the two crosswalks are different, then this method might be disadvantageous because placing both crosswalks on a single phase requires identical timing parameters for both crosswalks.

Split phasing is used infrequently at signalized intersections because a more efficient conventional phasing plan can usually be found. The following conditions could indicate that split phasing might be an appropriate design choice:

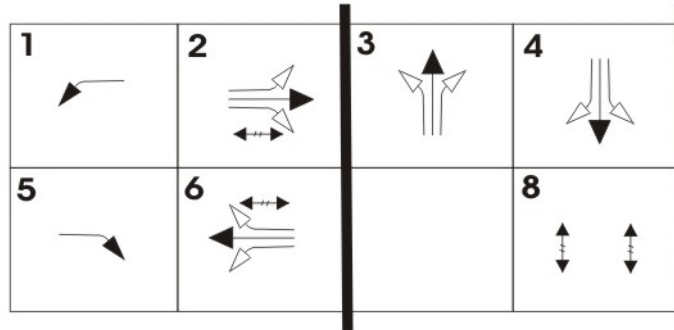
- There is a need to accommodate multiple turn lanes on an approach, but sufficient width is not available to provide separate lanes. Therefore, a shared through/left lane is required. An operational analysis should be performed to ensure this option is superior compared to a single turn lane option under various phasing scenarios.
- The left-turn lane volumes on two opposing approaches are approximately equal to the through traffic lane volumes and the total approach volumes are significantly different on the two approaches. Under these somewhat unusual conditions, split phasing may prove to be more efficient than conventional phasing.
- A pair of opposing approaches is physically offset such that the opposing left turns could not proceed simultaneously or a permissive left turn could not be expected to yield to the opposing through movement.
- The angle of the intersection is such that the paths of opposing left turns would not be forgiving of errant behavior by turning motorists.
- The safety experience indicates an unusual number of crashes (usually sideswipes or head-on collisions) involving opposing left turns. This may be a result of unusual geometric conditions that impede visibility of opposing traffic.
- A pair of opposing approaches each has only a single lane available to accommodate all movements and the left turns are heavy enough to require a protected phase.
- One of the two opposing approaches has heavy demand and the other has minimal demand. Under this condition, the signal phase for the minimal approach would be skipped frequently and the heavy approach would function essentially as the stem of a T intersection.



(a) Method A: Consecutive pedestrian phases using one ring.



(b) Method B: Consecutive pedestrian phases using "exclusive" settings in controller.
 Note: Separate "exclusive" setting must be used for phases 4 and 8; otherwise, operation results in simultaneous display of phases 4 and 8.



- Pedestrian Phase
- Permissive Phase
- Protected Phase

(c) Method C: Concurrent pedestrian phases using two rings.

Figure 32. Typical phasing diagrams for split phasing.

No standard method is provided in the MUTCD for indicating split phasing at an intersection, and the methods vary considerably depending on what type of phasing sequence has been used. A common way to implement method A or B described above involves using a four-section head displaying both a green ball and a green left-turn arrow simultaneously, as shown in figure 33. This method does not require the use of additional signs. Note that additional measures are needed with method C, as the protected left-turn arrow conflicts with the concurrent pedestrian phase, as follows:⁽⁵⁰⁾

- A special logic package can be used to suppress the green arrow display whenever the pedestrian phase is being served.
- A static sign indicating “LEFT TURN YIELD TO PEDS ON GREEN (symbolic green ball)” can be located next to the leftmost signal head for emphasis.
- A blankout sign indicating “LEFT TURN YIELD TO PEDS” can be activated when the conflicting vehicular and pedestrian phases are running concurrently.

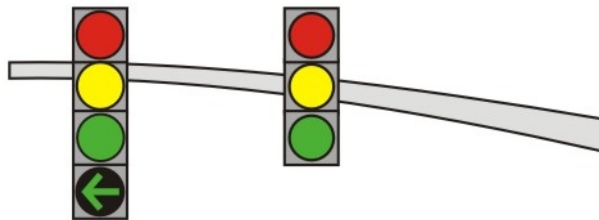


Figure 33. Common signal head arrangement for split phasing.

4.2.5 Prohibited Left-Turn Phasing

An alternative to providing a left-turn phase is to prohibit left-turn movements at the subject intersection. Under this scenario, left-turning drivers would be required to divert to another facility or turn in advance or beyond the intersection via a geometric treatment such as a jughandle or median U-turn. Left-turns can be prohibited on a full- or part-time basis. The amount of traffic diverted, effects on transit routes, the adequacy of the routes likely to be used, and community impacts are all important issues to consider when investigating a turn prohibition. A variety of treatments that redirect left turns are discussed in chapter 10.

4.2.6 Right-Turn Phasing

Right-turn phasing may be controlled in a permissive or protected manner with different configurations depending on the presence of pedestrians and lane configuration at the intersections.

Right turns have been operated on overlap phases to increase efficiency for the traffic signal. An overlap is a set of outputs associated with two or more phase combinations. As described earlier, various movements can be assigned to a particular phase. In some instances, right-turn movements operating in exclusive lanes can be assigned to more than one phase that is not conflicting. In this instance, a right turn is operated at the same time as the left turn, as shown in figure 34. The overlap forms a separate movement that derives its operation from its assigned phases (also called parent phases); for example, overlap A (OL A) is typically assigned to phase 2 (the adjacent through phase) and phase 3 (the nonconflicting left-turn phase from the cross street). During a transition between two parent phases, the overlap will remain green. To

implement this type of true overlap, a three-section head with limited visibility must be used, as the right-turn display may be different from the adjacent through phase.

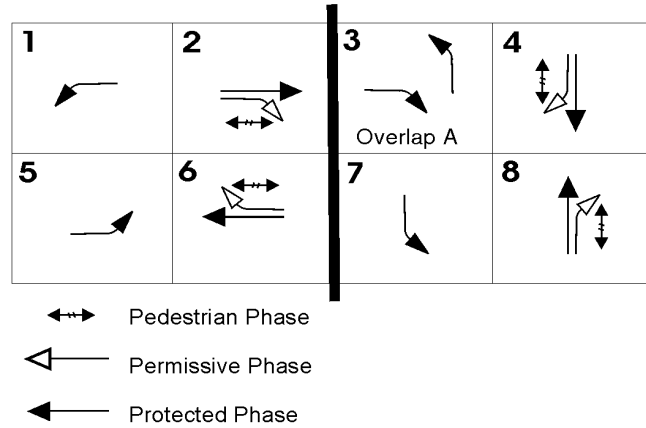
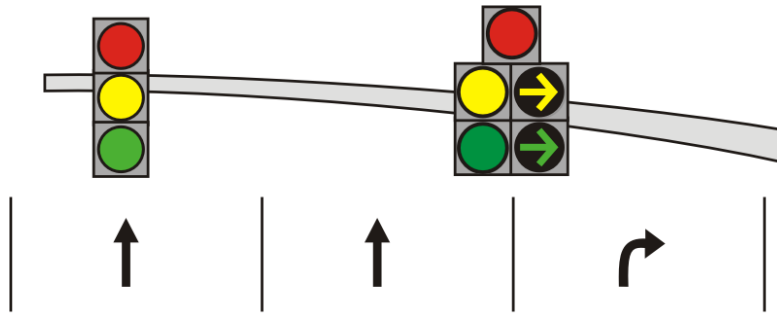
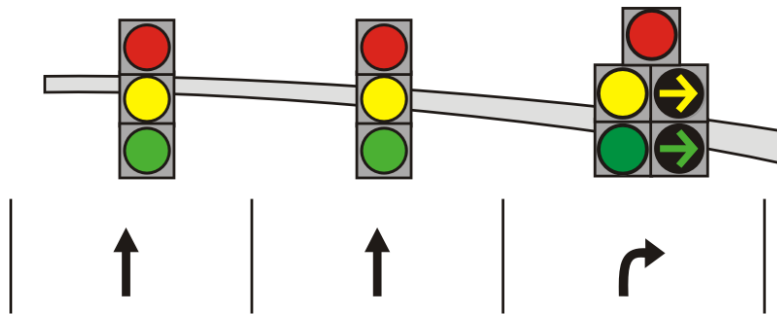


Figure 34. Typical phasing diagram illustrating a right-turn overlap.

More commonly, a five-section head with a combination of circular and arrow indications is used. Note that the MUTCD requires the display of a yellow change interval between the display of a green right-turn arrow and a following circular green display that applies to the continuing right-turn movement on a permissive basis. This yellow change interval is necessary to convey the change in right-of-way from fully protected during the green arrow to requiring a yield to pedestrians and other vehicles during the circular green. This can be implemented by assigning the right-turn arrows to the same phase as the nonconflicting left-turn phase on the cross street and the circular indications to the same phase as the adjacent through movement. A typical five-section signal head that implements protected-permissive right-turn phasing is shown in figure 35; refer to the MUTCD for other configurations.



(a) Right-turn overlap phasing using a five-section head located directly above the lane line that separates the exclusive through and exclusive right-turn lane.



(b) Right-turn overlap phasing using a five-section signal head centered above the right-turn lane.

Figure 35. Common signal head and signing arrangements for right-turn-overlap phasing.

This type of operation increases efficiency by providing more green time to this right-turn movement but may compromise the intersection's usability for visually impaired pedestrians. The transition from the protected right-turn movement on the green arrow to the permissive right-turn movement on the green ball masks the sound of the adjacent through vehicles. This makes it difficult for visually impaired pedestrians to hear when the adjacent through vehicles begin to move, which is used as an audible cue for crossing the street. Therefore, the use of accessible pedestrian signals to provide an audible indication of the start of the pedestrian phase may be needed to restore this cue.

4.3 VEHICLE AND PEDESTRIAN DISPLAYS

Signal displays can be generally categorized into those for vehicles and for pedestrians. The following sections discuss each type.

4.3.1 Vehicle Displays

The location of signal heads should be evaluated based on visibility requirements and type of signal display. While signal head placement is governed by MUTCD requirements for signal displays (discussed earlier in this chapter), the specific placement of signal heads is typically determined by local policies. When designing the placement of signal heads, the following should be considered in addition to the minimum requirements described in the MUTCD:

- Consistency with other intersections in the area.
- A geometric design issue that could confuse a driver.

- A large percentage of vehicles on one or more approaches that block lines of sight including trucks and vans.
- The width of the intersection.
- The turning paths of the vehicles.

At large signalized intersections, the safety and operation of the intersection may be enhanced through the use of additional signal heads, some of which are standard in some States. Figure 36 shows a typical intersection design with five types of optional heads:

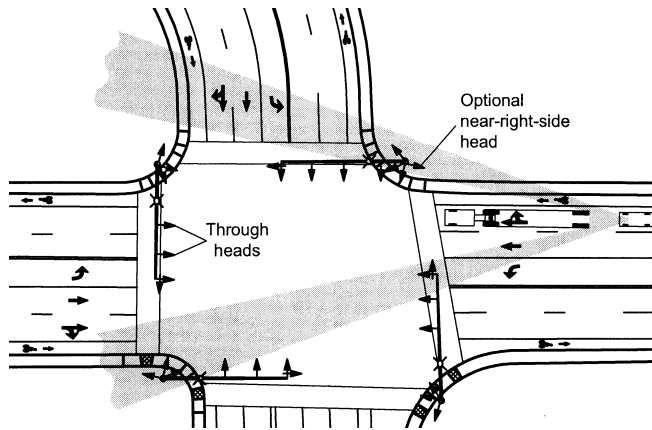
Optional Head #1: This is a near-right-side side head that can be used to provide an advanced head at wide intersections as well as provide a supplemental head for vehicles that are unable to see the signal heads over the lanes due to their position behind large vehicles (trucks, etc.).

Optional Head #2: This is an extra through head that can be used to supplement the overhead signal heads. This head provides an indication for vehicles that might be behind large vehicles and may be more visible than the overhead signal head when the sun is near the horizon.

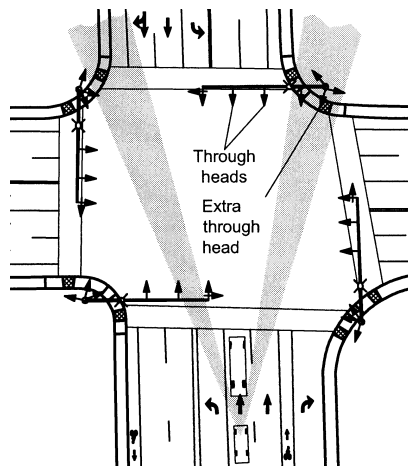
Optional Head #3: This is an extra left-turn head that can be used to guide left-turning vehicles across a wide intersection as they make their turn. It also helps visibility for vehicles behind large vehicles and for times of day when the sun is near the horizon.

Optional Head #4: This is a near-left-side head that can be used to provide an advance indication if visibility is hampered by a curve in the road upstream of the intersection.

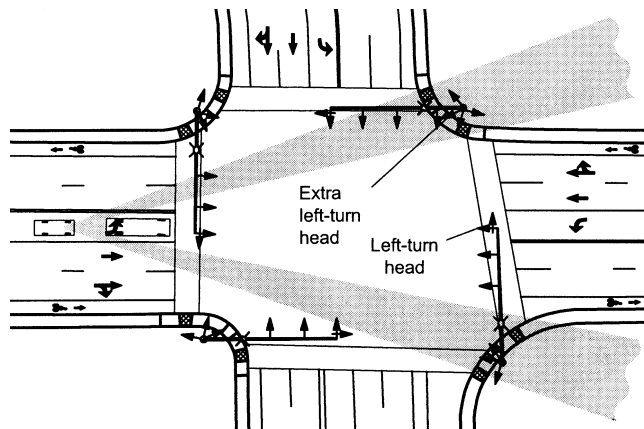
Optional Head #5: This is a head that can be used to provide a display in direct view of a right-turn lane and can also be used to provide a right-turn overlap phase in conjunction with the nonconflicting left-turn phase on the cross street. The head should contain either three circular balls or be a five-section head with three balls and two right-turn arrows due to the concurrent pedestrian crossing.



(a) Optional Head #1: Near-side head for through vehicles.

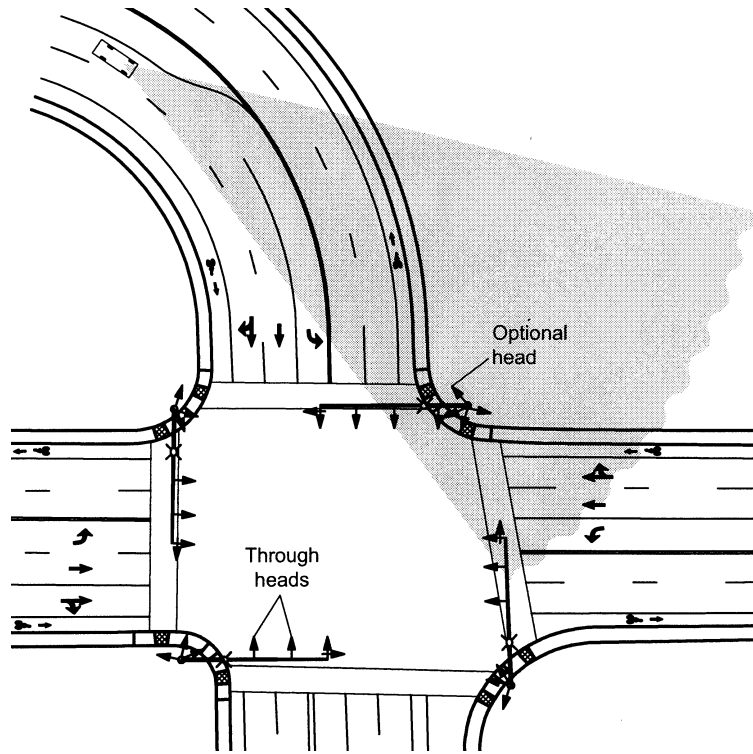


(b) Optional Head #2: Far-side supplemental head for through vehicles.

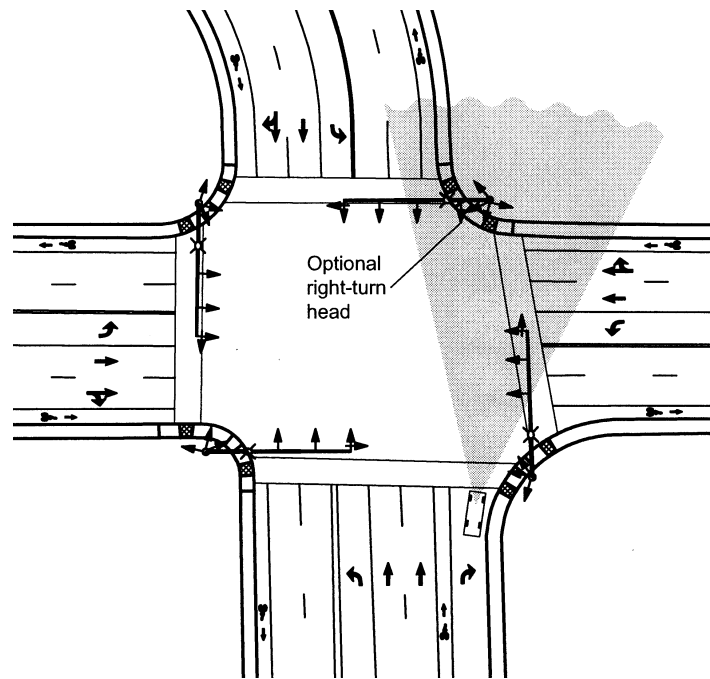


(c) Optional Head #3: Far-side supplemental head for left-turning vehicles.

Figure 36. Examples showing five optional signal head locations.



(d) Optional Head #4: Near-side head on curving approach.



(e) Optional Head #5: Far-side head for right-turning vehicles.

Figure 36. Examples showing five optional signal head locations, continued.

4.3.2 Pedestrian Displays

According to section 4E.03 of the 2003 MUTCD, pedestrian signal heads must be used in conjunction with vehicular traffic control signals under any of the following conditions:⁽¹⁾

- If a traffic control signal is justified by an engineering study and meets either Warrant 4, Pedestrian Volume, or Warrant 5, School Crossing (see MUTCD chapter 4C).
- If an exclusive signal phase is provided or made available for pedestrian movements in one or more directions, with all conflicting vehicular movements being stopped.
- At an established school crossing at any signalized location.
- Where engineering judgment determines that multiphase signal indications (as with split-phase timing) would tend to confuse or cause conflicts with pedestrians using a crosswalk guided only by vehicular signal indications.

Pedestrian signals should be used under the following conditions:

- If it is necessary to assist pedestrians in making a reasonably safe crossing or if engineering judgment determines that pedestrian signal heads are justified to minimize vehicle-pedestrian conflicts.
- If pedestrians are permitted to cross a portion of a street, such as to or from a median of sufficient width for pedestrians to wait, during a particular interval but are not permitted to cross the remainder of the street during any part of the same interval.
- If no vehicular signal indications are visible to pedestrians, or if the vehicular signal indications that are visible to pedestrians starting or continuing a crossing provide insufficient guidance for them to decide when it is reasonably safe to cross, such as on one-way streets, at T-intersections, or at multiphase signal operations.

The MUTCD provides specific guidance on the type and size of pedestrian signal indications (section 4E.04). As noted in the MUTCD, all new pedestrian signals should use the UPRAISED HAND (symbolizing DON'T WALK) and WALKING PERSON (symbolizing WALK) indications, shown in figure 37. The pedestrian displays must be mounted so that the bottom of the pedestrian signal display housing (including mounting brackets) is no less than 2.1 m (7 ft) and no more than 3 m (10 ft) above sidewalk level.⁽¹⁾



Figure 37. Pedestrian signal indications.

Some signalized intersections have factors that may make them difficult for pedestrians who have visual disabilities to cross safely and effectively. As noted in the MUTCD (section 4E.06), these factors include:⁽¹⁾

- Increasingly quiet cars.
- Right turn on red (which masks the sound of the beginning of the through phase).
- Continuous right-turn movements.
- Complex signal operations (e.g., protected-permissive phasing, lead-lag phasing, or atypical phasing sequences).
- Wide streets.

To address these challenges, accessible pedestrian signals have been developed to provide information to the pedestrian in a nonvisual format, such as audible tones, verbal messages, and/or vibrating surfaces. Detail on these treatments can be found in the MUTCD⁽¹⁾ and in several references sponsored by the U.S. Access Board and the National Cooperative Highway Research Program (NCHRP).^(51,52,53)

4.4 TRAFFIC SIGNAL POLE LAYOUT

Three primary types of signal configurations display vehicle signal indications:

- Pedestal or post-mounted signal displays.
- Span-wire configurations.
- Mast arms.

Table 13 identifies the advantages and disadvantages of each configuration.

Table 13. Advantages and disadvantages of various configurations for displaying vehicle signal indications.

Advantages	Disadvantages
Pedestal (post-mounted) vehicle signal <ul style="list-style-type: none"> • Low cost • Less impact on view corridors • Lower maintenance costs • Esthetics 	<ul style="list-style-type: none"> • Difficult to meet MUTCD visibility requirements, particularly at large signalized intersections
Span wire vehicle signal <ul style="list-style-type: none"> • Can accommodate large intersections • Flexibility in signal head placement • Lower cost than mast arms 	<ul style="list-style-type: none"> • Higher maintenance costs • Wind and ice can cause problems • May be considered aesthetically unpleasing
Mast arm vehicle signal <ul style="list-style-type: none"> • Provides good signal head placement • Lower maintenance costs • Many pole esthetic design options 	<ul style="list-style-type: none"> • More costly than span wire • Mast arm lengths can limit use and be extremely costly for some large intersections

In addition to providing support for the optimal location of vehicle and pedestrian signal indications, signal poles need to be located carefully to address the following issues:

- Pedestrian walkway and ramp locations.
- Pedestrian pushbutton locations, unless separate pushbutton pedestals are provided.
- Clearance from the travel way.
- Available right-of-way and/or public easements.

- Overhead utility conflicts, as most power utilities require at least 3.0 m (10 ft) clearance to power lines.
- Underground utilities, as most underground utilities are costly to relocate and therefore will impact the location of signal pole foundations.

The MUTCD,⁽¹⁾ the ADAAG,⁽³³⁾ and the AASHTO *Roadside Design Guide*⁽⁵⁴⁾ all contain guidance regarding the lateral placement of signal supports and cabinets. Generally, signal poles should be placed as far away from the curb as possible, not conflict with the pedestrian walking paths, and be located for easy access to the pushbuttons by disabled pedestrians. In some circumstances, it may be difficult or undesirable to locate a single pole that adequately serves both pedestrian ramps and provides adequate clearances. In these cases, one or more pedestals with the pedestrian signal heads and/or pushbuttons should be considered to ensure visibility of the pedestrian signal heads and accessibility to the pushbuttons.

4.5 TRAFFIC SIGNAL CONTROLLER

The traffic controller is the brain of the intersection. There are two general categories of traffic signal controllers: pre-timed and actuated. In the past two decades, most electro-mechanical and early solid-state controllers have been replaced with NEMA, 170, and advanced traffic controllers (ATC), even in locations where the signal is operated in a pre-timed mode. Although most modern controllers can perform the functions needed at typical signalized intersections, some may not be able to handle: more complicated configurations (e.g., intersections with more than four legs or two closely spaced intersections); communications with other controllers of dissimilar brands; or accommodation of priority treatments (e.g., transit priority). Therefore, the choice of controller may play a significant role in the types of treatments that can be considered at a signalized intersection.

Traffic controllers can be generally classified into three types:

1. NEMA.
2. Type 170.
3. ATC.

Some advantages and disadvantages of each type are described in table 14.

Table 14. Traffic signal controller advantages and disadvantages.

Advantages	Disadvantages
<p>NEMA Controller</p> <ul style="list-style-type: none"> • Specific vendor software • Reduced software/hardware problems 	<ul style="list-style-type: none"> • Cabinets are not standardized • Proprietary software • Proprietary features may not be interchangeable with other NEMA controllers • Typically require larger cabinets • May require extra spare parts if different models exist within one jurisdiction
<p>Type 170 Controller</p> <ul style="list-style-type: none"> • Standard layout and design • Many software choices • More easily adapted to special applications (i.e., ramp metering and Intelligent Transportation Systems (ITS)). • Reduced spare parts inventory 	<ul style="list-style-type: none"> • Software and hardware compatibility problems • Software can be expensive • Liability can be greater with separate software/hardware vendors
<p>Advanced Traffic Controllers (ATC and 2070)</p> <ul style="list-style-type: none"> • Compatible with the National Transportation Communications for ITS Protocol (NTCIP) • Much faster processing speeds • Additional phase inputs • Flexibility for ITS applications 	<ul style="list-style-type: none"> • Lack of proven software • Expensive • Current variations may not be interchangeable

In locating the controller cabinet, consider the following:

- It should not interfere with sight lines for pedestrians or right-turning vehicles.
- It should be in a location that is less likely to be struck by an errant vehicle and where it does not impede pedestrian circulation, including wheelchairs and other devices that assist mobility.
- A technician at the cabinet should be able to see the signal indications for two approaches while standing at the cabinet.
- The cabinet should be located near the power source.
- The cabinet location should afford ready access by operations and maintenance personnel, including consideration for where personnel would park their vehicle.

4.6 DETECTION DEVICES

The detectors (or sensors) at an intersection inform the signal controller that a vehicle, pedestrian, or bicycle is present at a defined location within the intersection or signal system. The controller then uses this information to determine the amount of green time and the signal phases to serve.

4.6.1 Vehicle Detection

Table 15, excerpted from the final draft of the *Traffic Detector Handbook*, 2003 edition, presents an overview of the strengths and weaknesses of commercially available detector technology.⁽⁵⁵⁾ The good performance of in-roadway detectors such as inductive loops, magnetic, and magnetometer detectors is based, in part, on their close location to the vehicle, which makes them insensitive to inclement weather due to a high signal-to-noise ratio. Their main disadvantage is their in-roadway installation, necessitating physical changes in the roadway as part of the installation process. In addition, in-roadway detectors may be damaged or disrupted by utility cuts, pavement milling operations for resurfacing, and movement of pavement joints and cracks. Over-roadway detectors often provide data not available from in-roadway sensors, and

some can monitor multiple lanes with one unit. The reader is encouraged to refer to the *Traffic Detector Handbook* for further discussion on detector technology.

Vehicle detectors provide advanced detection, left-turn lane presence detection, and stop-bar presence detection. Advanced detection extends a green signal to get an approaching vehicle through the signal. Left-turn lane presence detection detects left-turning vehicles that are waiting. Stop-bar presence detection will pick up any vehicles that may have entered to roadway from driveways and vehicles that might not have made it though the intersection on the previous green.

A fourth detector function is as a system detector. On many large streets with coordinated signal systems, system detectors are used to collect midblock vehicle volume and occupancy data, which is analyzed by a master signal controller or central system to determine whether signal timing changes are needed. The location of the system detectors varies based on the signal system and software being used, but typically they are located downstream of the intersection on the major roadway.

The location of the advanced detectors is often based on the dilemma zone boundary. The dilemma zone is that portion of the approach where a driver suddenly facing a yellow indication must make a decision whether to stop safely or to proceed through the intersection. As a result, the dilemma zone boundary is typically dictated by the minimum stopping distance. The actual distances vary by jurisdictional policies and should be reviewed before the traffic signal is designed. The typical location for advance detectors based on stopping sight distance is shown in table 16.

Table 15. Strengths and weaknesses of commercially available detector technologies.

Technology	Strengths	Weaknesses
Inductive Loop	<ul style="list-style-type: none"> • Flexible design to satisfy large variety of applications • Mature, well understood technology • Large experience base • Provides basic traffic parameters (e.g., volume, presence, occupancy, speed, headway, and gap) • Insensitive to inclement weather such as rain, fog, and snow • Provides best accuracy for count data as compared with other commonly used techniques • Common standard for obtaining accurate occupancy measurements • High frequency excitation models provide classification data 	<ul style="list-style-type: none"> • Installation requires pavement cut • Improper installation decreases pavement life • Installation and maintenance require lane closure • Wire loops subject to stresses of traffic and temperature • Multiple detectors usually required to monitor a location • Detection accuracy may decrease when design requires detection of a large variety of vehicle classes • Destroyed by utility cuts or pavement milling operations
Magnetometer (two-axis fluxgate magnetometer)	<ul style="list-style-type: none"> • Less susceptible than loops to stresses of traffic • Insensitive to inclement weather such as snow, rain, and fog. • Some models transmit data over wireless radio frequency (RF) link 	<ul style="list-style-type: none"> • Installation requires pavement cut • Improper installation decreases pavement life • Installation and maintenance require lane closure • Models with small detection zones require multiple units for full lane detection
Magnetic (induction or search coil magnetometer)	<ul style="list-style-type: none"> • Can be used where loops are not feasible (e.g., bridge decks) • Some models are installed under roadway without need for pavement cuts, but boring under roadway is required • Insensitive to inclement weather such as snow, rain, and fog. • Less susceptible than loops to stresses of traffic 	<ul style="list-style-type: none"> • Installation requires pavement cut or tunneling under roadway • Cannot detect stopped vehicles unless special sensor layouts and signal processing software are used
Microwave Radar	<ul style="list-style-type: none"> • Typically insensitive to inclement weather at the relatively short ranges encountered in traffic management applications • Direct measurement of speed • Multiple lane operation available 	<ul style="list-style-type: none"> • Continuous Wave (CW) doppler sensors cannot detect stopped vehicles

Source: Adapted from reference 55.

Table 15. Strengths and weaknesses of commercially available sensor technologies, continued.

Technology	Strengths	Weaknesses
Active Infrared (laser radar)	<ul style="list-style-type: none"> • Transmits multiple beams for accurate measurement of vehicle position, speed, and class • Multiple-lane operation available 	<ul style="list-style-type: none"> • Operation may be affected by fog when visibility is less than ~6 m (20 ft) or blowing snow is present • Installation and maintenance, including periodic lens cleaning, require lane closure
Passive Infrared	<ul style="list-style-type: none"> • Multizone passive sensors measure speed 	<ul style="list-style-type: none"> • Passive sensor may have reduced vehicle sensitivity in heavy rain, snow, and dense fog • Some models not recommended for presence detection
Ultrasonic	<ul style="list-style-type: none"> • Multiple-lane operation available • Capable of overheight vehicle detection • Large Japanese experience base 	<ul style="list-style-type: none"> • Environmental conditions such as temperature change and extreme air turbulence can affect performance; temperature compensation is built into some models • Large pulse repetition periods may degrade occupancy measurement on freeways with vehicles traveling at moderate to high speeds
Acoustic	<ul style="list-style-type: none"> • Passive detection • Insensitive to precipitation • Multiple lane operation available in some models 	<ul style="list-style-type: none"> • Cold temperatures may affect vehicle count accuracy • Specific models are not recommended with slow moving vehicles in stop-and-go traffic
Video Image Processor	<ul style="list-style-type: none"> • Monitors multiple lanes and multiple detection zones/lanes • Easy to add and modify detection zones • Rich array of data available • Provides wide-area detection when information gathered at one camera location can be linked to another 	<ul style="list-style-type: none"> • Installation and maintenance, including periodic lens cleaning, require lane closure when camera is mounted over roadway (lane closure may not be required when camera is mounted at side of roadway) • Performance affected by inclement weather such as fog, rain, and snow; vehicle shadows; vehicle projection into adjacent lanes; occlusion; day-to-night transition; vehicle/road contrast; and water, salt grime, icicles, and cobwebs on camera lens • Requires 15- to 21-m (50- to 70-ft) camera mounting height (in a side-mounting configuration) for optimum presence detection and speed measurement • Some models susceptible to camera motion caused by strong winds or vibration of camera mounting structure • Generally cost-effective when many detection zones within the camera field-of-view or specialized data are required

Source: Adapted from reference 55.

Table 16. Location of advanced vehicle detectors.

Speed	Calculated Stopping Distance	Single Detector Setback	Multiple Detector Setback	
			10% Probability of Stopping	90% Probability of Stopping
33 km/h (20 mph)	22.0 m (72.2 ft)	21 m (70 ft)	—	—
40 km/h (25 mph)	31.8 m (104.4 ft)	32 m (105 ft)	—	—
48 km/h (30 mph)	42.9 m (140.8 ft)	43 m (140 ft)	—	—
56 km/h (35 mph)	55.7 m (182.9 ft)	56 m (185 ft)	31 m (102 ft)	77 m (254 ft)
64 km/h (40 mph)	70.4 m (231.0 ft)	70 m (230 ft)	37 m (122 ft)	87 m (284 ft)
72 km/h (45 mph)	86.5 m (283.8 ft)	*	46 m (152 ft)	100 m (327 ft)
80 km/h (50 mph)	104.2 m (341.9 ft)	*	52 m (172 ft)	108 m (353 ft)
88 km/h (55 mph)	123.8 m (406.3 ft)	*	71 m (234 ft)	118 m (386 ft)

* Use multiple detectors or volume-density modules.

Source: (Reference 56 (table 7-1); reference 57 (table 4-3); metric values converted from U.S. customary provided in sources)

As shown in table 16, the stopping distance can be computed for both the average stopping condition as well as the probability ranges for stopping. For most large intersections, a multiple-loop design should be used to account for the higher speeds and probabilities of stopping. More detailed information on detector placement, including the results of several calculation methods, can be found in the *Manual of Traffic Detector Design*.⁽⁵⁸⁾

4.6.2 Pedestrian Detection

Pedestrian detection at actuated signals is typically accomplished through the use of pedestrian push buttons. Accessible pedestrian signal detectors, or devices to help pedestrians with visual or mobility impairments activate the pedestrian phase, may be pushbuttons or other passive detection devices. For pushbuttons to be accessible, they should be placed in accordance with the guidance in the MUTCD and located as follows (sections 4E.08 and 4E.09):⁽¹⁾

- Adjacent to a level all-weather surface to provide access from a wheelchair with a wheelchair-accessible route to the ramp.
- Within 1.5 m (5 ft) of the crosswalk extended.
- Within 3 m (10 ft) of the edge of the curb, shoulder, or pavement.
- Parallel to the crosswalk to be used.
- Separated from other pushbuttons by a distance of at least 3 m (10 ft).
- Mounted at a height of approximately 1.1 m (3.5 ft) above the sidewalk.

Alternative methods of pedestrian detection, including infrared and microwave detectors, are emerging. Additional information on these devices can be found in FHWA's *Pedestrian Facilities User Guide—Providing Safety and Mobility*.⁽³⁵⁾

4.7 BASIC SIGNAL TIMING PARAMETERS

Signal operation and timing have a significant impact on intersection performance. Controllers have a vast array of inputs that permit tailoring of controller operation to the specific intersection. This section provides guidance for the determination of basic timing parameters.

The development of a signal timing plan should address all user needs at a particular location including pedestrians, bicyclists, transit vehicles, emergency vehicles, automobiles, and trucks. For the purposes of this section, signal timing is divided into two elements: pedestrian timing and vehicle timing.

4.7.1 Pedestrian Timing

Pedestrian timing requirements include a WALK interval and a flashing DON'T WALK interval. The WALK interval varies based upon local agency policy. The MUTCD recommends a minimum WALK time of 7 s, although WALK times as low as 4 s may be used if pedestrian volumes and characteristics do not require an interval of 7 s (section 4E.10).⁽¹⁾ The WALK interval gives pedestrians adequate time to perceive the WALK indication and depart the curb before the clearance interval (flashing DON'T WALK) begins.

In downtown areas, longer WALK times are often appropriate to promote walking and serve pedestrian demand. School zones and areas with large numbers of elderly pedestrians also warrant consideration and the display of WALK time in excess of the minimum WALK time.

The MUTCD states that the pedestrian clearance time should allow a pedestrian crossing in the crosswalk to leave the curb and travel to at least the far side of the traveled way or to a median of sufficient width for pedestrians to wait before opposing vehicles receive a green indication. The MUTCD uses a walk speed of 1.2 m/s (4.0 ft/s) for determining crossing times.⁽¹⁾ However, the *Pedestrian Facilities Users Guide* recommends a lower speed of 1.1 m/s (3.5 ft/s); see chapter 2 for further discussion.⁽³⁵⁾ Pedestrian clearance time is calculated using equation 1:

$$\text{Pedestrian Clearance Time} = \frac{\text{Crossing Distance}}{\text{Walking Speed}} \quad (1)$$

where: Pedestrian Clearance Time is in seconds
Crossing Distance is measured from the near curb to at least the far side of the traveled way or to a median; and
Walking Speed is typically 1.2 m/s (4 ft/s) or 1.1 m/s (3.5 ft/s) as indicated above.

Pedestrian clearance time is accommodated during either a combination of flashing DON'T WALK time and yellow clearance time or by flashing DON'T WALK time alone. The recommended practice is for the pedestrian clearance time to be accommodated completely within the flashing DON'T WALK time. However, at high-volume locations, it may be necessary as a tradeoff for vehicular capacity to use the yellow change interval as part of satisfying the calculated pedestrian clearance time.

4.7.2 Vehicle Timing—Green Interval

Ideally, the length of the green display should be sufficient to serve the demand present at the start of the green phase for each movement and should be able to move groups of vehicles, or platoons, in a coordinated system. At an actuated intersection, the length of the green interval varies based on inputs received from the detectors. Minimum and maximum green times for each phase are assigned to a controller to provide a range of allowable green times. Detectors are used to measure the amount of traffic and determine the required time for each movement within the allowable range.

The minimum green time is the amount of time allocated to each phase so that vehicles in queue at the stop bar are able to start and clear the intersection. The minimum initial green time is established by determining the time needed to clear the vehicles located between the stop bar and the detector nearest the stop bar. Where presence detection is installed at the stop bar, a minimum interval may be set to a value that is less than 1.0 s.

Consider an intersection with the following properties: average vehicle spacing is 7.5 m (25 ft) per vehicle, initial start-up time is 2 s, and vehicle headway is 2 s per vehicle. For an approach with a detector located 30 m (100 ft) from the stop bar, the minimum green time is $2 + (30 \text{ m}/7.5 \text{ m} \times 2) = 2 + (100 \text{ ft}/25 \text{ ft} \times 2) = 10 \text{ s}$.

The maximum green time is the maximum limit to which the green time can be extended for a phase in the presence of a call from a conflicting phase. The maximum green time begins when a

call is placed on a conflicting phase. The phase is allowed to "max-out" if the maximum green time is reached even if actuations have been received that would typically extend the phase.

4.7.3 Vehicle Timing—Detector Timing

One advantage of actuated control is that it can adjust timing parameters based on vehicle or pedestrian demand. The detectors and the timing parameters allow the signal to respond to varied flow throughout the day. For pedestrians, detectors are located for convenient access; for vehicles, detector spacing is a function of travel speed and the characteristics of the street. The operation of the signal is highly dependent on detector timing. More information about detector timing, including settings for various detector configurations, is found in the FHWA *Traffic Detector Handbook*.⁽⁵⁵⁾

One type of detector timing, known as volume-density timing, uses gap timers to reduce the allowable gap time the longer the signal is green. This type of timing makes the signal less likely to extend the green phase the longer the signal is green. A typical setting for a volume-density controller is to have the passage gap set to twice the calculated gap time to ensure the phase does not gap out too early. The minimum gap time might be set to less than the calculated gap time on multiple lane approaches, depending on the characteristics of the intersection.

Signal timing parameters may provide an opportunity to maximize the efficiency of the intersection. Signal timing parameters control how quickly the phase ends once traffic demand is no longer present. The one phase that is the exception is the coordinated phase, which receives the unused or additional time.

4.7.4 Vehicle Timing—Vehicle Clearance

The vehicle clearance interval consists of the yellow change and red clearance intervals. The recommended practice for computing the vehicle clearance interval is the ITE formula (reference 56, equation 11-4), given in equation 2 (to use with metric inputs, use 1 m = 0.3048 ft):

$$CP = t + \frac{V}{2a + 64.4g} + \frac{W + L}{V} \quad (\text{U.S. Customary}) \quad (2)$$

where:

- CP = change period (s)
- t = perception-reaction time of the motorist (s); typically 1
- V = speed of the approaching vehicle (ft/s)
- a = comfortable deceleration rate of the vehicle (ft/s²); typically 10 ft/s²
- W = width of the intersection, curb to curb (ft)
- L = length of vehicle (ft); typically 20 ft
- g = grade of the intersection approach (%); positive for upgrade, negative for downgrade

For change periods longer than 5 s, a red clearance interval is typically used. Some agencies use the value of the third term as a red clearance interval. The MUTCD does not require specific yellow or red intervals but provides guidance that the yellow change interval should be approximately 3 s to 6 s and that the red clearance interval should not exceed 6 s (section 4D.10).⁽¹⁾ Note that because high-volume signalized intersections tend to be large and frequently on higher speed facilities, their clearance intervals are typically on the high end of the range. These longer clearance intervals increase loss time at the intersection and thus reduce capacity.

The topic of yellow and red clearance intervals has been much debated in the traffic engineering profession. At some locations, the yellow clearance interval is either too short or set improperly due to changes in posted speed limits or 85th-percentile speeds. This is a common problem and frequently causes drivers to brake hard or to run through the intersection during the red phase. Because not all States follow the same law with regard to what is defined as "being in the intersection on the red phase," local practice for defining the yellow interval varies

considerably. For this reason, red light photo enforcement should not be used during the period of red clearance required by the ITE formula.

Current thought is that longer clearance intervals will cause drivers to enter the intersection later and will breed disrespect for the traffic signal. Wortman and Fox conducted a study that showed that the time of entry of vehicles into the intersection increased due to a longer yellow interval.⁽⁵⁹⁾ Additional research is needed to examine the effect of lengthening the yellow interval on driver behavior.

4.7.5 Vehicle Timing—Cycle Length

For isolated, actuated intersections, cycle length varies from cycle to cycle based on traffic demand and signal timing parameters. For coordinated intersections, a background cycle length is used to achieve consistent operation between consecutive intersections. In general, shorter cycle lengths are preferable to longer ones because they result in less delay and shorter queues. However, the need to accommodate multiple pedestrian movements across wide roadways, coupled with complex signal phasing and minimum green requirements to accommodate signal progression in multiple directions, may sometimes require the use of even longer cycle lengths. Wherever possible, such use should be limited to peak traffic periods only.

In general, it is preferred that the cycle lengths for conventional, four-legged intersections not exceed 120 s, although larger intersections may require longer cycle lengths. Longer cycle lengths generally result in increased delay and queues to all users, particularly minor movements. There may also be a connection between longer cycle lengths and increased incidence of red-light running, although this has not been documented in research. Although longer cycle lengths result in fewer change periods per hour and thus fewer opportunities for red-light running, more drivers may be tempted to run the red light to avoid the extra delay caused by the longer cycle length.⁽⁶⁰⁾

4.8 SIGNING AND PAVEMENT MARKING DESIGN

Signs and pavement markings are important elements of the design of an intersection. Because of the complexity of driver decisions, particularly at large signalized intersections, special attention to signing and pavement markings can maximize the safety and efficiency of the intersection. At signalized intersections, these traffic control devices serve several key functions, including:

- Advance notice of the intersection.
- Directional route guidance.
- Lane use control, including indications of permissive or prohibited turning movements.
- Regulatory control of channelized right turn movements (e.g., through the use of YIELD signs).
- Delineation and warning of pedestrian crossing locations.
- Delineation and warning of bicycle lane locations.

The FHWA's MUTCD⁽¹⁾ is the primary reference for use in the design and placement of signs and pavement markings. Additional resources include State supplements to the MUTCD and reference materials such as ITE's *Traffic Control Devices Handbook* (TCDH)⁽⁶¹⁾ and *Traffic Signing Handbook*.⁽⁶²⁾

Designing effective signing and pavement marking at high-volume signalized intersections in particular often requires thinking beyond standard drawings of typical sign and pavement marking layouts at intersections. High-volume signalized intersections typically have more lanes than most intersections. They may have redirected or restricted turning movements. They often join two or more designated routes (e.g., State highways) that require directional guidance to the user. They are also frequently in urban areas where other intersections, driveways, and urban land use

create visibility conflicts. The following questions, adapted from the ITE *Traffic Signing Handbook*⁽⁶²⁾, represent a basic thought process that is recommended for engineers to follow when developing a sign layout at an intersection:

1. **From a given lateral and longitudinal position on the roadway, what information does the user need, both in advance and at the intersection?** At signalized intersections, is information on lane use at the intersection provided? Is advance street name information (“XX Street, Next Signal,” etc.) and (if appropriate) route number directional signage provided in advance of the intersection? Figure 38 gives an example of a simple advance street name sign on approach to an intersection, and figure 39 gives an example of an advance sign that provides street names for the next two signalized intersections.



Figure 38. Example of advance street name sign for upcoming intersection.



Figure 39. Example of advance street name sign for two closely spaced intersections.

2. **Are there any on- or off-road conditions that would violate driver expectancy?** Lane drops, trap lanes, and right-hand exits for left turns are all examples where driver expectancy is violated and should be addressed by signing. Figure 40 shows an example of signage used to advise motorists of a trap lane.



Figure 40. Example of signing for a left-hand lane trap.

3. **Is a specific action required by a road user?** If the road user needs to be in an appropriate lane in advance of an intersection to make a movement at the intersection, signage is needed to convey this message to the user. Figure 41 provides an example of an overhead signs used to assist drivers in selecting the proper lane on approach to a signalized intersection.



Figure 41. Example of advance overhead signs indicating lane use for various destinations.

4. **Are signs located so that the road user will be able to see, comprehend, and attend to the intended message?** Signs must be simple enough to be easily comprehended and attended to before the driver receives the next message. This requires adequate sign size, sign spacing, and attention to the number of elements on each sign. This may, for example, lend itself to the use of overhead signs in advance of large intersections, as well as large retroreflectorized or internally illuminated overhead signs (including street name signs) at intersections.
5. **For what part of the driver population is the sign being designed?** Have the needs of older drivers or nonlocal drivers been accommodated? This may require the use of larger lettering or sign illumination.
6. **Does the sign “fit in” as part of the overall sign system?** Signing at an intersection needs to be consistent with the overall sign layout of the connecting road system. For example, the consistent use of guide signs is helpful to freeway users in identifying the appropriate exit. Similar consistency is needed on arterial streets with signalized intersections.

Pavement markings also convey important guidance, warning, and regulatory lane-use information to users at signalized intersections. In addition to delineating lanes and lane use, pavement markings clearly identify pedestrian crossing areas, bike lanes, and other areas where driver attention is especially important. Where in-pavement detection is installed for bicycles and motorcycles, appropriate markings should be painted to guide these vehicles over the portion of the loop that will best detect them.

Several supplemental pavement markings are particularly useful at large signalized intersections. For example, the use of lane line extensions into the intersection can be a helpful tool where the intersection is so large that the alignment of through or turning lanes between

entering the intersection and exiting the intersection could be confused. This can occur, for example, where multiple turn lanes are provided, where the through lane alignments make a curve through the intersection, or where the receiving lanes at an intersection are offset laterally from the approach lanes. In addition, pavement legends indicating route numbers and/or destinations in advance of the intersection (i.e., “horizontal signage”) may be used to supplement signing for this purpose, as shown in figure 42.



Figure 42. Example of pavement legends indicating destination route numbers (“horizontal signage”)

4.9 ILLUMINATION DESIGN

As noted in *American National Standard Practice for Roadway Lighting (RP-8-00)*, “[t]he principal purpose of roadway lighting is to produce quick, accurate, and comfortable visibility at night. These qualities of visibility may safeguard, facilitate, and encourage vehicular and pedestrian traffic...[T]he proper use of roadway lighting as an operative tool provides economic and social benefits to the public including:

- (a) Reduction in night accidents, attendant human misery, and economic loss.
- (b) Aid to police protection and enhanced sense of personal security.
- (c) Facilitation of traffic flow.
- (d) Promotion of business and the use of public facilities during the night hours.”^(63, p.1)

Specifically with respect to intersections, the document notes that “[s]everal studies have identified that the primary benefits produced by lighting of intersections along major streets is the reduction in night pedestrian, bicycle and fixed object accidents.” (section 3.6.2)⁽⁶³⁾ With respect to signalized intersections, roadway lighting can play an important role in enabling the intersection to operate at its best efficiency and safety. The highest traffic flows of the day (typically the evening peak period) may occur during dusk or night conditions where lighting is critically important, particularly in winter for North American cities in northern latitudes.

The document includes three different criteria for roadway lighting: illuminance, luminance, and small target visibility (STV). These are described as follows:

- Illuminance is the amount of light incident on the pavement surface from the lighting source.
- Luminance is the amount of light reflected from the pavement toward the driver's eyes. The luminance criterion requires more extensive evaluation. Because the reflectivity of the pavement surfaces constantly changes over time, it is difficult to accurately estimate this criterion.
- Small target visibility is the level of visibility of an array of targets on the roadway. The STV value is determined by the average of three components: the luminance of the targets and background, the adaptation level of adjacent surroundings, and the disability glare.

4.9.1 Illuminance

The two principal measures used in the illuminance method are light level and uniformity ratio. Light level represents the intensity of light output on the pavement surface and is reported in units of lux (metric) or footcandles (U.S. Customary). Uniformity represents the ratio of either the average-to-minimum light level (E_{avg}/E_{min}) or the maximum-to-minimum light level (E_{max}/E_{min}) on the pavement surface. The light level and uniformity requirements are dependent on the roadway classification and the level of pedestrian night activity.

The basic principle behind the lighting of intersections is that the amount of light on the intersection should be proportional to the classification of the intersecting streets and equal to the sum of the values used for each separate street. For example, if Street A is illuminated at a level of x and Street B is illuminated at a level of y , the intersection of the two streets should be illuminated at a level of $x+y$. RP-8-00 also specifies that if an intersecting roadway is illuminated above the recommended value, then the intersection illuminance value should be proportionately increased. If the intersection streets are not continuously lighted, a partial lighting system can be used. RP-8-00 and its annexes should be reviewed for more specific guidance on partial lighting, the specific calculation methods for determining illuminance, and guidance on the luminance and STV methods.⁽⁶³⁾

Table 17 presents the recommended illuminance for the intersections within the scope of this document located on continuously illuminated streets. Separate values have been provided for portland cement concrete road surfaces (RP-8-00 Road Surface Classification R1) and typical asphalt concrete road surfaces (RP-8-00 Road Surface Classification R2/R3).

Table 18 presents the roadway and pedestrian area classifications used for determining the appropriate illuminance levels in table 17. RP-8-00 clarifies that although the definitions given in table 18 may be used and defined differently by other documents, zoning bylaws, and agencies, the area or roadway used for illumination calculations should best fit the descriptions contained in table 18 (section 2.0, p. 3).⁽⁶³⁾

4.9.2 Veiling Luminance

Veiling luminance is produced by stray light from light sources within the field of view. This stray light is superimposed in the eye on top of the retinal image of the object of interest, which alters the apparent brightness of that object and the background in which it is viewed. This glare, known as disability glare, reduces a person's visual performance and thus must be considered in the design of illumination on a roadway or intersection (annex C).⁽⁶³⁾ Table 17 shows the maximum veiling luminance required for good intersection lighting design.

Table 17. Recommended illuminance for the intersection of continuously lighted urban streets.

Pavement Classification ²	Roadway Classification	Average Maintained Illuminance at Pavement ¹			Uniformity Ratio (Eavg/Emin) ³	Veiling Luminance Ratio (Lvmax/Lavg) ⁴
		Pedestrian/Area Classification				
		High (lux (fc))	Medium (lux (fc))	Low (lux (fc))		
R1	Major/Major	24.0 (2.4)	18.0 (1.8)	12.0 (1.2)	3.0	0.3
	Major/Collector	20.0 (2.0)	15.0 (1.5)	10.0 (1.0)	3.0	0.3
	Major/Local	18.0 (1.8)	14.0 (1.4)	9.0 (0.9)	3.0	0.3
	Collector/Collector	16.0 (1.6)	12.0 (1.2)	8.0 (0.8)	4.0	0.4
	Collector/Local	14.0 (1.4)	11.0 (1.1)	7.0 (0.7)	4.0	0.4
	Local/Local	12.0 (1.2)	10.0 (1.0)	6.0 (0.6)	6.0	0.4
R2/R3	Major/Major	34.0 (3.4)	26.0 (2.6)	18.0 (1.8)	3.0	0.3
	Major/Collector	29.0 (2.9)	22.0 (2.2)	15.0 (1.5)	3.0	0.3
	Major/Local	26.0 (2.6)	20.0 (2.0)	13.0 (1.3)	3.0	0.3
	Collector/Collector	24.0 (2.4)	18.0 (1.8)	12.0 (1.2)	4.0	0.4
	Collector/Local	21.0 (2.1)	16.0 (1.6)	10.0 (1.0)	4.0	0.4
	Local/Local	18.0 (1.8)	14.0 (1.4)	8.0 (0.8)	6.0	0.4

Notes: ¹ fc = footcandles

² R1 is typical for portland cement concrete surface; R2/R3 is typical for asphalt surface.

³ Eavg/Emin = Average illuminance divided by minimum illuminance

⁴ Lvmax/Lavg = Maximum veiling luminance divided by average luminance.

Source: Reference 63, table 9 (for R2/R3 values); R1 values adapted from table 2.

Table 18. RP-8-00 guidance for roadway and pedestrian/area classification for purposes of determining intersection illumination levels.

Roadway Classification	Description	Average Daily Vehicular Traffic Volumes (ADT) ¹
Major	That part of the roadway system that serves as the principal network for through-traffic flow. The routes connect areas of principal traffic generation and important rural roadways leaving the city. Also often known as "arterials," thoroughfares," or "preferentials."	More than 3,500
Collector	Roadways servicing traffic between major and local streets. These are streets used mainly for traffic movements within residential, commercial, and industrial areas. They do not handle long, through trips.	1,500 to 3,500
Local	Local streets are used primarily for direct access to residential, commercial, industrial, or other abutting property.	100 to 1,500

Pedestrian Conflict Area Classification	Description	Possible Guidance on Pedestrian Traffic Volumes ²
High	Areas with significant numbers of pedestrians expected to be on the sidewalks or crossing the streets during darkness. Examples are downtown retail areas, near theaters, concert halls, stadiums, and transit terminals.	More than 100 pedestrians/hour
Medium	Areas where lesser numbers of pedestrians use the streets at night. Typical are downtown office areas, blocks with libraries, apartments, neighborhood shopping, industrial, older city areas, and streets with transit lines.	11 to 100 pedestrians/hour
Low	Areas with very low volumes of night pedestrian usage. These can occur in any of the cited roadway classifications but may be typified by suburban single family streets, very low density residential developments, and rural or semirural areas.	10 or fewer pedestrians/hour

Notes: ¹ For purposes of intersection lighting levels only.

² Pedestrian volumes during the average annual first hour of darkness (typically 18:00-19:00), representing the total number of pedestrians walking on both sides of the street plus those crossing the street at non-intersection locations in a typical block or 200 m (656 ft) section. RP-8-00 clearly specifies that the pedestrian volume thresholds presented here are a local option and should not be construed as a fixed warrant.

Source: Reference 63, sections 2.1, 2.2, and 3.6

Part II

Project Process and Analysis Methods

Part II describes the key elements of a typical project process (chapter 5) from project initiation to implementation and monitoring. Part II also includes a description of safety analysis methods (chapter 6) and operational analysis methods (chapter 7) that can be used in the evaluation of a signalized intersection. The chapters in part II provide the reader with the tools needed to determine deficiencies of a signalized intersection and areas for improvement and mitigation. The findings from part II should be used to identify applicable treatments in part III.

CHAPTER 5

PROJECT PROCESS

TABLE OF CONTENTS

5.0	PROJECT PROCESS	99
5.1	Project Initiation.....	99
5.2	Identify Stakeholder Interests and Objectives	99
5.2.1	Intersection Users	100
5.2.2	Adjacent Property/Business Owners	100
5.2.3	Facility Managers	100
5.2.4	Other Decisionmakers	100
5.3	Data Collection.....	101
5.3.1	Office Review.....	101
5.3.2	Field Investigation	101
5.4	Problem Identification.....	102
5.4.1	Establish Performance Measures and Criteria	105
5.4.2	Summarize Operational and Safety Conditions.....	107
5.4.3	Develop Problem Statement.....	107
5.5	Identify Problem Cause.....	108
5.6	Treatment Selection.....	109
5.6.1	Identify Range of Treatments.....	109
5.6.2	Evaluate Treatments.....	110
5.6.3	Assess Potential To Introduce Undesirable Effects.....	110
5.6.4	Determine Costs and Implementation Issues	110
5.7	In-Service Assessments	111
5.7.1	Followup Plan.....	111
5.7.2	Monitoring Program	111

LIST OF TABLES

<u>Table</u>		<u>Page</u>
19	Example stakeholder interests and objectives	101
20	User characteristics	103
21	Operational characteristics	103
22	Safety characteristics.....	104
23	Geometric, traffic signal control, and land use characteristics	104
24	Policy and background information.....	105
25	Common concerns raised by stakeholders	105
26	Example performance measures and criteria.....	106
27	Possible causes of intersection problems	109

5. PROJECT PROCESS

This chapter describes a standard process for conducting an intersection design/redesign project. During the initial stages of a project, stakeholders are identified, the scope of analysis is determined, data are collected, and key issues of concern are identified. From this information, a problem statement is developed and potential countermeasures or treatments are identified. In the alternatives evaluation stage, potential treatments are evaluated for feasibility and effectiveness. After a treatment is chosen, the improvement is implemented and monitored over time. This chapter describes a general thought process to guide readers to issues to consider and questions to ask.

5.1 PROJECT INITIATION

An intersection project typically begins with notification to a lead engineer. The engineer could be a city, county, or State traffic engineer responding to a concern raised by the public, a supervisor, a planning commission, or a city council. In other cases, the lead engineer may be a consultant responding to a request for proposal for a particular intersection design project. During this process, the lead engineer should gather initial information that will lead to identification of problems. Information should be gathered through stakeholder interviews, review of existing data, and field visits as described in the following sections.

Two questions that should be asked at the outset of the process are:

1. Does the project involve a new or existing intersection?
2. Does the intersection experience system-wide effects?

New intersections typically afford greater flexibility for design and the selection of treatments than do existing ones. Existing intersections are often constrained by utility placement, presence of development surrounding the intersection, and issues related to construction and to maintenance of traffic. The effect of a treatment at an existing location must take into account the effect on user expectancy. Changes to way-finding, lane geometry, and traffic control may result in confusion and, in turn, create a safety deficiency.

Determining whether an intersection condition is part of a system problem is an important consideration when evaluating intersection treatments. For certain cases, a capacity improvement to an intersection may provide little benefit if the constraining point on the system is located upstream or downstream of the intersection. Likewise, implementing an improvement such as a turn movement restriction may solve an operational or safety problem at the subject intersection, but may result in the migration of the problem to a new location. These system effects must be considered at each step in the treatment evaluation and selection process.

5.2 IDENTIFY STAKEHOLDER INTERESTS AND OBJECTIVES

Each project should begin by identifying the affected stakeholders and conducting stakeholder interviews to define interests, goals, and objectives. Stakeholders include any person or group affected by a project: users of the facility (motorists, pedestrians, bicyclists, etc.); adjacent property owners and residents; jurisdictional owners and managers of the facility; and decisionmakers who have influence over making improvements to the facility.

The interest range of stakeholders is widespread: A local business owner may be solely concerned with maintaining access for his/her business; a neighborhood group may want pedestrian treatments to improve the safety for a pedestrian crossing; and a traffic engineer may want to maximize throughput on the mainline facility. A planning commission may recommend yet another treatment based on concerns raised from its constituents.

It is important to highlight the interests of all stakeholders and clearly define their goals and objectives early in the process. This includes defining jurisdictional policies and standards regarding the safety and operations of the intersection. Stakeholders' goals and objectives need

to be considered carefully and acknowledged at each step of the process, and should be tied to performance measures to provide a means for evaluation.

The following sections identify usual stakeholders and provide direction to readers for highlighting the interests, goals, and objectives for each.

5.2.1 Intersection Users

Intersection users include motorists, pedestrians, bicyclists, and transit riders (see chapter 2 for a more complete discussion of user types). These users may be categorized in subgroups with similar concerns and issues (e.g., citizens from a neighborhood group, disabled persons, truck drivers).

It is important to understand how the goals and objectives of each user group relate to each other, and the tradeoffs that exist between them. For example, lane-widening improvements that are implemented to solve an operational deficiency for motorists may reduce the safety and quality of service for pedestrians due to the number of conflicts added and the increased crossing distance. In some cases, the benefits experienced by one user group may be offset by the negative impacts imposed on another.

5.2.2 Adjacent Property/Business Owners

The access and circulation needs for adjacent properties and business owners should be addressed based on an evaluation of the land use, traffic demand, and access needs of each site. Air quality and noise impacts to adjacent properties and businesses are also important consideration when evaluating improvement alternatives.

5.2.3 Facility Managers

Stakeholders include the owners and managers of the facility such as State departments of transportation engineers and city and county planning and public works staff. Facility managers typically are expected to meet an adopted standard or policy for the facility. As part of the stakeholder identification process, relevant and adopted documents such as State highway plans, comprehensive plans, and transportation system plans should be reviewed to identify the transportation standards and policies in place that may affect the study intersection. In addition, jurisdiction officials should be contacted and interviewed to identify plans for system improvement that may affect the characteristics or demand patterns at an intersection.

5.2.4 Other Decisionmakers

It is also important to consider other decisionmakers in addition to local jurisdiction officials, including technical advisory committee members, steering committee members, planning commissioners, city councilors, and other government officials. It is important to gain an understanding of the criteria that each of these decisionmakers uses in evaluating recommendations and making decisions. Driving forces may include local policy, local politics, agencies/organizations represented, and level of ownership and commitment to the project.

A summary of the key concerns and issues of each stakeholder should be prepared and circulated to relevant project team members to ensure that everyone has a clear understanding of the constraining factors of a project. Table 19 provides an example of cataloging stakeholder interests and objectives.

Table 19. Example stakeholder interests and objectives.

Stakeholder	Primary Interest	Objectives
Motorist	Mobility, ease of commute	Coordinated signal system—limited stop-and-go conditions
Pedestrian	Mobility and safety	Fewer conflicts, reduced crossing distance, direct connections, adequate facilities
Bicyclist	Mobility and safety	Provision of bike lane, minimized conflicts with motor vehicles, extended clearance interval
State Traffic Engineer	Mobility on State highway	Maximize throughput on mainline
City Planner	Long-term operations	Obtain necessary right-of-way and funding to construct improvements sufficient through a 20-year horizon to accommodate all modes
City Engineer	Safety	Minimize severity and frequency of crashes
Neighborhood Group	Pedestrian/bicycle access	Provide bike/pedestrian connections linking residential area with shopping district
Business Owner	Access	Maintain full-access turn movements at driveways
Planning Commissioner	Compliance with local standards and policies	Ensure intersection meets operations standards and intent of policy for safety, accessibility, and pedestrian/bicyclist/transit usability

5.3 DATA COLLECTION

Data acquisition and field investigation provides an understanding of the physical and operational characteristics of the study intersection and identify factors that contribute to its deficiencies. All information required for analysis and evaluation should be obtained in this step. The amount and type of data required for analysis is dependent upon the analysis method selected. Additional site visits may be required after the initial visit to obtain supplementary data. A description of the analysis methods available for safety and operational evaluation, along with specific data requirements, are described in chapters 6 and 7. The following sections describe the data that should be collected and obtained for an office review and field investigation.

5.3.1 Office Review

Office reviews include obtaining relevant safety, operations, and design data from available resources (e.g., local public works and planning departments, State department of transportation offices, and Internet sites). As-built drawings and aerial photography should be obtained for this effort. Past studies conducted within the study area should also be obtained. In general, the office review should make use of all data that can be obtained without extraordinary expenditures.

5.3.2 Field Investigation

Field investigations should be performed to observe safety and operating conditions. Everyone involved with evaluating and recommending improvements to an intersection should visit the site. Three perspectives should be considered.

1. User perspective: visibility, ability to process information, decisionmaking, level of service, and conflicts for all user types.
2. Intersection perspective: operations and safety performance, geometric characteristics, movements operating with high delay/overcapacity, safety conflicts, signal timing, signing, and pavement markings.
3. System perspective: impacts of upstream/downstream intersections, influence of adjacent driveways, location relative to other facility types.

The site visit should occur during peak-hour traffic conditions. Additional field visits may be appropriate for the following conditions:

- Off-peak periods.
- Night.
- Inclement weather.
- Special events.

Observations of events and physical characteristics should be noted. Photographs and video should be made for reference and use in presentations and reports.

During the observation, vehicle queues and travel patterns through the intersection should be examined and noted if they interfere with upstream driveways and/or intersections. Likewise, arrival patterns, modal distribution, operations, and closely spaced downstream traffic signals should be observed to determine if they affect, or are affected by, operations at the subject intersection. Special conditions such as nearby pedestrian/bicyclist generators, transit transfer points, and populations with special needs should be noted. The type and operating characteristics of nearby commercial establishments and institutions may have an important effect on the intersection and should also be noted. The intersection's relationship to other important system components (e.g., freeways, principal arterials, and even sensitive neighborhoods) must be recognized. To assess the system-wide impacts of a potential improvement, it is necessary to understand how the study intersection interacts with its surrounding facilities.

The following tables provide a description of the data items that should be collected as part of the office review and field investigation stages. Table 20 identifies user characteristics, table 21 identifies operational characteristics, and table 22 identifies safety characteristics. Table 23 identifies physical characteristics such as geometry, traffic signal control, and land use, and table 24 lists key policy and background information that should be obtained.

5.4 PROBLEM IDENTIFICATION

Problems at an intersection are identified through a synthesis of stakeholder interviews, office reviews, field investigations, and preliminary operational and safety analysis. To determine whether a problem exists, this information needs to be evaluated against defined goals or standards. A problem statement can be defined after a review of the established operational and safety criteria against the known characteristics of an intersection. In some cases, additional data may need to be collected to confirm that a problem exists.

The steps for identifying problems as described in this chapter are: (1) establish performance measures and criteria; (2) summarize operational and safety conditions; and (3) develop a problem statement.

Table 20. User characteristics.

Data Item	Description	Determines
Motor vehicle traffic volumes	Includes ADT volumes for a roadway segment and peak-hour turning-movement volumes for existing and future year conditions	Travel patterns, high-demand (critical) movements, appropriate number of lanes for a roadway approach
Origin-destination information	Detailed description of vehicle movements classified by start and end points	Expected lane utilization, whether a weaving condition is expected, impact a turn movement restriction may have on surrounding area
Heavy vehicle data	Identification of number and type of trucks, percentage of trucks by movement	Appropriate design vehicle for geometric evaluation, whether special consideration is warranted to account for heavy vehicle movements
Pedestrian and bicyclist demand	Volume and/or demand and location of pedestrian and bicyclist movements as well as location of nearby generators and attractors	The level of activity that needs to be accounted for in the design and signal timing of an intersection

Table 21. Operational characteristics.

Data Item	Description	Determines
Capacity analysis	Evaluation of traffic operations for either a planning level, macroscopic, or microscopic level analysis (see chapter 7 for details on performing an operational analysis)	Critical movements, volume-to-capacity ratio, average intersection delay, level of service, vehicle queues, pedestrian capacity and level of service, bicycle capacity and level of service
Delay study	Measure time each vehicle (car, truck, transit, or bicycle) enters and discharges from queue; measure time each pedestrian arrives and departs; measure available gaps in the traffic stream for pedestrians to cross	Average delay per vehicle by approach, average pedestrian delay, average bicycle delay, average transit delay
Saturation flow study	Measure time headway for vehicles discharging from a stopped position	Average saturation headway and loss time per approach
Queue observations	Identify location of maximum back of queue and number of vehicles in queue	Required storage lengths, whether queues interfere with upstream driveways or intersections
Vehicle speeds	Identification of 85 th percentile speeds and posted speeds for all approaches	Whether a speeding condition exists, signal design parameters

Table 22. Safety characteristics.

Data Item	Description	Determines
Crash history	Includes summary of reported crashes for past 3 to 5 years	Whether excessive crashes are occurring when compared to crash data for similar facilities
Conflict study	Identification of conflicts and near-collisions	Potential for collisions
Collision diagram	Diagram illustrating location, type, and severity of reported collisions	Whether a pattern in crashes exists
Interview with local police and jurisdiction officials	Identification of anecdotal evidence regarding crash history of intersection	History and background of an intersection's safety condition

Table 23. Geometric, traffic signal control, and land use characteristics.

Data Item	Description	Determines
Lane configuration	Number of lanes on approach, lane use type (shared vs. exclusive), presence of add/drop lanes, free-flow movements, storage lengths for turn bays, and distance to nearby driveways and intersections	Presence of weaving sections, adjacent driveways/ intersections within influence of intersection, presence of short lanes
Pedestrian facilities	Location and configuration of crosswalks, ramps, accessible treatments, pedestrian signal equipment, and network connectivity	Pedestrian crossing distance, compliance with ADA requirements, traffic signal needs
Bicycle facilities	Location and configuration of bicycle lanes, detection equipment, and network connectivity	Bicycle facility needs, traffic signal needs
Roadway/ intersection geometric data	Cross slopes, channelization features, posted and prevailing speeds, lane widths, right-of-way locations, median type, horizontal and vertical curve data, corner radii, presence of bicycle/pedestrian/transit facilities, sight distance, and presence of offsets/skews	Whether physical constraints exist; right-of-way available to accommodate improvements; presence of horizontal or vertical curves that may affect sight distance and speeds
Illumination drawings	Location, type, and wattage of street lighting	Whether lighting is adequate
Roadside features	Location and type of roadside elements including drainage ditches, trees, shrubs, buildings, signs, street lights, signal poles, etc.	Whether roadside elements may be leading to fixed-object crashes, sight distance deficiencies, or driver confusion
Traffic signal phasing and timing plans	Type of signal control (actuated or pre-timed), coordinated/noncoordinated operations, cycle length, left-turn phasing type, phase order, and timing parameters (loss time, clearance intervals, min/max greens, unit extension, etc.)	Whether intersection is located in a coordinated system; whether left-turn phasing treatments such as permissive or protected-permissive may be a cause of collisions
Adjacent land uses	Size and type of use, location and type of driveways, circulation patterns, design vehicles	Access needs for local land uses

Table 24. Policy and background information.

Data Item	Description	Determines
Planned developments and transportation improvements in the area	Location, site, type, and completion date of planned and approved developments; description of improvement project, limits of project, and scheduled construction dates	Additional traffic volumes that may affect facility; impacts to travel patterns that can be expected from an improvement project
Functional classification of roadways	Description of facility type for intersecting roadways	System-wide function of intersecting roadways
Design standards	Standards for lane widths, medians, curb radii, sidewalks, bike lanes, curb ramps, signal timing, etc.	Requirements for intersection design; may indicate that design modifications are needed
Applicable plans and studies	All applicable access management plans, corridor studies, transportation system plans, traffic impact studies, bicycle and pedestrian plans, ADA transition plan, etc.	Existing and projected future safety/operational characteristics of intersection

5.4.1 Establish Performance Measures and Criteria

The selection of performance measures should be made on a case-by-case basis; the measures should address concerns raised by stakeholders and issues identified during the office review and field investigation. Table 25 lists common concerns of motorists, pedestrians, transit riders, bicyclists, and facility managers.

Table 25. Common concerns raised by stakeholders.

Motorists	Pedestrians	Transit Riders/Operators	Bicyclists	Facility Managers
<ul style="list-style-type: none"> • Takes more than one signal cycle to get through intersection • High delays • Queue spillback • Too many stops • Inefficient signal timing • Too many crashes • High severity of crashes • Poor sight distance • Vehicle speeds too high • Confusing signing 	<ul style="list-style-type: none"> • Inadequate facilities • Wait time too long • Crossing distance too far • Vehicle speeds too fast • Ramps and/or pushbuttons poorly located • Too many conflicts • Inability to identify when to begin crossing 	<ul style="list-style-type: none"> • Bus stop inaccessible • Bus stop impedes vehicle movement • Bus stop poorly located for pedestrians to use • Difficult for bus to merge into traffic stream 	<ul style="list-style-type: none"> • Facilities not adequate • Clearance interval too short • Lane striping ineffective • Unsafe/too many conflicts with vehicles 	<ul style="list-style-type: none"> • Local/Statewide policy not met • Not in compliance with comprehensive plan, transportation system plan, corridor plan, etc. • Construction impacts and maintenance of traffic during construction • Fiscal, land use, and right-of-way constraints

Ideally, performance measures are quantitative and can be measured for a future-year condition to evaluate the long-term effects of potential treatments. Certain cases, however, may require selection of qualitative performance measures, particularly when evaluating characteristics such as driver expectations and pedestrian/bicyclist comfort.

Once performance measures are defined that adequately address the scope of the issues, desired performance levels should be established for each measure. This process should take

into account local policy and standards, driver expectations, operational and safety levels at similar facilities, and research findings. All decisionmakers on a project should agree on the performance levels established.

Desired levels of performance should be defined for all study periods and years. For operational evaluations, the typical weekday peak hour(s) should be included in the evaluation. Other conditions may be included as deemed necessary. Operational performance levels should be established for year of opening and long-term (20 to 25 years) conditions. For safety evaluations, performance levels are generally established on an annual basis and evaluated over a period of 3 to 5 years.

The desired performance level may vary based on time of day and year. For an operational issue, a degraded level of performance may be tolerated for certain periods of the day while more stringent standards are applied for the remaining periods. Similarly, a worsened operating condition may be tolerated better under long-term conditions than near-term conditions.

In some cases, particularly for multimodal aspects, it may be difficult to establish quantifiable performance levels. Performance levels for these cases may be based on a design element (e.g., sidewalk width, buffer, distance to transit stop). Efforts should be made to establish quantifiable levels to effectively assess the impact of various treatments.

A list of example performance measures and criteria is provided in table 26. Numerical values in the performance level column were developed for a hypothetical example.

Table 26. Example performance measures and criteria.

Performance Measure	Concerns Addressed	Desired Performance Level (What is acceptable?)
Critical Movement Volume-to-Capacity Ratio	Motorist operations	0.90 (peak 15 minute period for 5-year condition); 1.00 (peak hourly period for 20-year condition)
Average Vehicle Delay	Motorist operations	55 seconds or less per vehicle (to achieve level of service (LOS) D or better)
Vehicle Queues	Motorist operations and safety	Eliminate queue spillback
Total Intersection Crashes	Motorist safety	Reduce existing crashes by 20%
Crash Severity	Motorist safety	Reduce fatal and injury crashes by 20%
Approach Speeds	Motorist, bicyclist, and pedestrian safety	Reduce 85th percentile prevailing speed by 16 km/h (10 mph)
Pedestrian Delay	Pedestrian operations	40 seconds or less per pedestrian (to achieve LOS D or better)
Pedestrian Accessibility	Pedestrian usability	Compliance with ADA standards
Total Bicycle Conflicts	Bicycle safety	Reduce number of bicycle-motor vehicle conflict points by 25%
Transit Delay	Transit operations	Reduce transit vehicle delay by 10%
Way-Finding	Motorist, bicyclist, and pedestrian operations and safety	Reduce intersection clutter, increase conspicuity of key road signs and signal heads, provide accessible routes for pedestrians

As shown in table 26, certain performance measures are readily quantifiable (critical movement volume-to-capacity ratio, average vehicle delay, queues), while others have a higher level of uncertainty for prediction (total intersection crashes, approach speeds) or require a qualitative assessment (multimodal impacts and way-finding). While some measures are not easily quantifiable, it is important that they be recognized and considered in the evaluation and selection of intersection treatments.

5.4.2 Summarize Operational and Safety Conditions

Problems at an intersection usually are related to a safety or operational deficiency. Defining a problem generally requires an assessment of performance from the perspective of all users of the intersection, regardless of mode of travel. At this stage in the project, a primary problem may have already been defined and be the cause for initiating the project. In these instances, the operations and safety conditions should be reviewed to confirm the problem exists and determine whether other problems exist or likely will exist in the future.

The level of effort required for determining operational and safety conditions at this stage varies from intersection to intersection. The information gathered through the stakeholder interviews and office review/field investigation may be sufficient in some cases, while other situations may require more extensive operational and safety evaluations.

Common questions that should be answered in evaluating intersection safety and operations are:

- Is sight distance adequate?
- Are red light running violations occurring?
- Does the intersection have enough capacity under existing and future conditions?
- Are pedestrian and bicycle facilities available, adequate, and supportive of existing or potential use?
- Is adequate queue storage available to accommodate all turn movements?
- Do signs and pavement markings clearly and accurately communicate the intended message?
- Do upstream or downstream intersections interfere with operations at the subject intersection?
- Are nearby driveways interfering with intersection operations?
- Is there a pattern of collision type or location?
- Are crashes occurring under inclement weather or nighttime conditions?

A complete description of analysis procedures that can be applied to estimate safety and operations conditions for signalized intersections and answer the above questions is provided in chapters 6 and 7.

5.4.3 Develop Problem Statement

After comparing the operational and safety conditions of an intersection against the established performance measures, problems and deficiencies should begin to emerge. Deficiencies should be expressed in terms of the user group (motorist, pedestrian, bicyclist, etc.) and reference the specific movement that initiates the problem as well as the time and duration during which the problem occurs. For example, a safety condition could be expressed as: *an excessive number of rear-end collisions involve vehicles traveling on the northbound approach during wet-weather conditions*. An operational problem could be stated as: *an eastbound left-turn movement operates over capacity during the weekday p.m. and Saturday peak periods*.

Problems should be stated in terms of the performance measures defined earlier in this chapter. Example problem statements follow.

- Excessive conflict for one or more movements.
- Excessive number of collisions or type of collision.
- Excessive number of injury/fatal collisions.
- Inadequate capacity for one or more movements.
- Excessive vehicle delay for one or more movements.
- Excessive vehicle queuing for one or more movements.
- Inaccessible pedestrian facilities.
- Excessive pedestrian crossing delay.
- Excessive transit delay.
- Excessive number of bicycle-motor vehicle conflicts.

5.5 IDENTIFY PROBLEM CAUSE

Once the problems at an intersection have been identified, initiative should be taken to determine the cause of each. The previous section explained that the effect of a problem is often a deficient safety or operational performance measure. The cause of the problem, in many cases, is attributable to a design element. As an example, a safety problem with an effect of a high occurrence of sideswipe collisions on an approach with dual left-turn lanes may be caused by inadequate lane width and a lack of delineation for the left-turn lanes.

Aerial photography and as-built drawings should be used to assist in the determination of problem cause. Results from the office review, field investigation, and preliminary analysis should also be used to determine possible causes. Detailed review of all elements of a signalized intersection, as described in previous chapters, are required to determine the cause of a problem.

Table 27 provides lists possible causes related to common operational and safety deficiencies. This list should be applied to specific movements and approaches where an operational or safety deficiency may be occurring.

Table 27. Possible causes of intersection problems.

Potential Cause	Delays	Queues	Collisions	Injury/Fatality Collisions
Effects from nearby intersections	√	√	√	√
Insufficient number of through lanes	√	√	√	√
Insufficient design or lack of turn lanes	√	√	√	√
Insufficient pedestrian crosswalk, ramps, landing area, and accessible facilities	√	√	√	√
Insufficient bicycle detection	√	–	√	√
Speed differential	–	–	√	√
Poor pavement conditions	–	–	√	√
Turning movements from adjacent driveways (poor access management)	√	√	√	√
Poor sight distance	–	–	√	√
Poor signal visibility	–	–	√	√
Inadequate signal phasing and/or timing (including vehicle and pedestrian clearance intervals)	√	√	√	√
Poor dilemma zone protection	–	–	√	√
Inadequate roadway lighting	–	–	√	√
Inadequate roadway signing	–	–	√	√
Inadequate pavement marking	–	–	√	√
Bicycle conflicts	√	–	√	√
Pedestrian conflicts	√	–	√	√
Bus conflicts	√	√	√	√

5.6 TREATMENT SELECTION

Treatments should be selected that address the specific areas for safety and operational improvement identified in the preceding stages of the intersection evaluation process. The primary objectives of the treatment selection stage are to (1) identify the range of treatments; (2) evaluate treatments; (3) assess potential for undesirable effects; and (4) determine costs and implementation issues.

5.6.1 Identify Range of Treatments

What treatments are likely to influence the areas for safety and operations improvement? The range of treatments provided in this guide are categorized into the following chapters:

- System-wide treatments (chapter 8).
- Intersection-wide treatments (chapter 9).
- Alternative intersection treatments (chapter 10).
- Approach treatments (chapter 11).
- Individual movement treatments (chapter 12).

A list of identified treatments is provided in chapter 1. A complete discussion of the safety, operational, and design characteristics of each treatment is provided in part III of this guide, which

also discusses the applicability of each treatment and identifies the problem and cause the treatment addresses. The level of detail provided for each treatment varies based on the amount of research and field evaluation available. It should be noted that treatments listed in this guide by no means represent the full extent of treatment possibilities.

5.6.2 Evaluate Treatments

Once possible treatments have been listed that could address the identified problems, it is necessary to evaluate the possible countermeasures to determine the potential for improvement to safety and operations. Treatment descriptions in part III describe the impact each treatment has on safety and operations. Where available, crash modification factors are provided to estimate the possible reduction in crashes. Operational benefits can be determined based on performing an analysis described in chapter 7.

5.6.3 Assess Potential To Introduce Undesirable Effects

In addition to considering the potential safety and operational improvements that countermeasures can offer, consideration needs to be given to the possibility that countermeasures can have negative effects. Efforts should be made to assess the likelihood of introducing undesirable safety or operational consequences through the implementation of recommended countermeasures. These undesirable effects include the potential for a treatment to result in:

- Out-of-direction travel.
- Increased speed.
- Cut-through traffic.
- Illegal maneuvers.
- Driver confusion.
- False expectations.
- Adverse impacts to pedestrians, cyclists, and transit users.
- Migration of a safety or operational condition to another location.

5.6.4 Determine Costs and Implementation Issues

Costs are usually assessed in three categories: capital costs, operating costs, and maintenance costs. Other issues that should be considered include right-of-way needs, ADA compliance, environmental impacts, constructability, and maintenance of traffic.

- Capital costs are normally associated with initial construction and implementation. The installation of traffic signals, for example, involves design, materials, construction, and installation costs normally paid for out of a capital program fund. This is normally a one-time cost. Where the capital investment is projected to occur some time in the future (e.g., grade separation 10 years from now), these costs must be discounted back to present value to enable a fair comparison with other alternatives.
- Operating costs are usually associated with consumables. In the case of traffic signals, the principle operating expense is electrical power for signal operation and illumination.
- Maintenance costs are periodic, recurring costs of keeping an initial investment productive. For traffic signals this may include the time and materials associated with monitoring, periodic retiming, replacing lamps, repairing malfunctions in timing and operation, and repairing and replacing damaged equipment.

- The amount of right-of-way required and the ability of the local agency to acquire needed property may influence the decision to implement a treatment.
- Treatments must also be evaluated to determine their potential impact on drainage, wetlands, historic landmarks, and archaeological features.
- The construction of a treatment may have a significant impact on the existing flow of vehicular and pedestrian traffic. Constructability issues and maintenance of traffic for each mode should be considered in the treatment evaluation stage.

The final decision to implement treatments should incorporate a wide range of parameters that decisionmakers deem appropriate. While operational benefits, safety benefits, and cost are key criteria, they are not the only elements that must be considered. Other criteria, such as coordination with other projects, special funding, and ADA transition plan requirements, may dictate the implementation and timing of a project.

5.7 IN-SERVICE ASSESSMENTS

5.7.1 Followup Plan

Identifying and documenting the physical and operational hazards determined during the safety assessment should be coupled with a followup plan. The plan should identify what measures will be taken by whom and when, and it should effectively communicate these decisions to each of the stakeholder groups identified above.

The objective of a followup plan is to ensure that the:

- Department, jurisdiction and/or agency responsible for implementing the proposed countermeasures is properly notified of the action required.
- Period to implement these countermeasures is properly conveyed, including urgency.
- Remedial measures, when completed, are done in accord with best practices, have addressed the hazard, and have not created unforeseen negative impacts on traffic operations or safety at the location.

Where the action of others is required to achieve the implementation of a recommendation, an appropriate followup system should be implemented. The system should endeavor to do more than simply monitor the status of other activities. If recommendations involve the need for design, those involved in the intersection evaluation process can use the followup process to comment on design and installation details before the remedial measures and countermeasures are ultimately installed. Staff familiar with the original intent of these measures should also ensure that the proposed measure was installed as directed.

5.7.2 Monitoring Program

A monitoring program should be developed to evaluate the impacts of countermeasures that are selected and implemented. The scope of the monitoring program will be a function of the nature of the countermeasures and their likely effects on operations and safety at and adjacent to the study location. Ideally, data would be collected prior to construction of a treatment to provide a benchmark for future comparisons. The objectives of the monitoring program are to:

- Focus on the dominant collision types to determine whether the recommended countermeasure has improved the performance at the specific location by causing a decline in the dominant collision types.
- Focus on the dominant operational deficiency to determine whether the recommended countermeasure has improved the performance at the specific location by reducing the delay and queuing experienced by motorists.
- Identify effects on all users.

- Ensure that the recommended treatment does not adversely affect safety or operations on the road network.
- Improve techniques and practices for identifying existing or potential operational concerns.
- Provide data that can be used in establishing quantitative safety measures, such as crash modification factors, for the road authority.
- Justify improvements to the road authority's transportation-related standards, policies, and procedures that are applied in all areas from transportation planning to roadway and right-of-way maintenance.

The monitoring program should have a clearly understood monitoring frequency, duration, and objectives, as appropriate for the measure installed. The need to advise stakeholders of the monitoring program should be considered, but may not always be necessary. However, should the monitoring program result in a modification or removal of the originally proposed countermeasures, further notification to the stakeholders is required.

A key goal of the program is to be able to continually improve the road system, constantly seeking to reduce the number of collisions that occur on roads within the jurisdiction and improve the operational efficiency.

CHAPTER 6

SAFETY ANALYSIS METHODS

TABLE OF CONTENTS

6.0	SAFETY ANALYSIS METHODS	115
6.1	Balancing Safety and Mobility	115
6.2	Selection of an Intersection	116
6.2.1	Collision Frequency	119
6.2.2	Collision Rate	119
6.2.3	Combined Collision Frequency and Rate Method	120
6.2.4	Collision Severity Method	120
6.2.5	Critical Collision Rate	121
6.2.6	Risk Analysis Methods	121
6.2.7	Safety Performance Functions	122
6.2.8	Empirical Bayes Method	122
6.2.9	Conclusions	123
6.3	Identification of Potential Problems	125
6.3.1	Safety Diagnosis	125
6.3.2	Assemble Collision Data	126
6.3.3	Analyze/Diagnose Collision Data	128
6.3.4	Determine Overrepresentation	129
6.3.5	Conduct Site Visit(s)	132
6.3.6	Deciding on Further Analysis	134
6.3.7	Conducting Further Studies	134
6.3.8	Defining the Problem Statement	135
6.4	Identification of Possible Treatments	136
6.4.1	List Possible Treatments	136
6.4.2	Screen Treatments	138
6.4.3	Selecting a Collision Modification Factor or Study Finding	139
6.4.4	Quantify Safety Benefit	140
6.4.5	Selected Treatment(s)	142
6.5	Improvement Plan Development	142

LIST OF FIGURES

<u>Figure</u>		<u>Page</u>
43	Exclusion of property-damage-only collisions (such as this one from an analysis) may mask valuable information	117
44	The potential for error in coding the location of a collision should be understood	118
45	Selecting a candidate intersection using a combined collision frequency/collision rate method, where each diamond represents an intersection	120
46	Example of SPF curve	122
47	Identification of potential problems	126
48	The original police collision report may contain valuable information regarding collisions that have occurred at the intersection	127
49	Possible taxonomy for collision type classification	131
50	Conducting a site visit	133
51	Examples of problem statements	135
52	Identification of possible treatments	136

LIST OF TABLES

<u>Table</u>		<u>Page</u>
28	Suggested weighting for collision severity method.....	121
29	Common methods of assessing safety at a location	124
30	Chi-square test values and corresponding confidence levels	129
31	Collision types commonly identified, possible causes, and associated treatments	138
32	Example calculation of safety benefit of adding a right-turn lane	141

6. SAFETY ANALYSIS METHODS

Decisions made at each step in the roadway life cycle are no longer dominated solely by mobility considerations; they must now be made in a context-sensitive manner and must address accessibility. At the planning stage, the need for and purpose of the project are examined. Safety, mobility, cost, and the preservation of resources must all be carefully considered in the design, operation, management, and rehabilitation phases of a roadway project. Quantifying the impacts of tradeoffs made at each step in the process is an essential element of the context-sensitive, flexible design process.

The explicit consideration of safety and the development of quantifiable safety information have greatly enhanced the flexible design process. The availability of quantifiable safety tools has helped elevate the role of safety in the design decision process, such that it may be considered on a par with competing demands such as mobility, sustainability, aesthetics, environmental impact, and cost.

Efforts to eliminate unnecessary cost while preserving needed functionality in the delivery of road infrastructure have led to the application of value analysis techniques to road designs. A key aspect in assessing the true societal value of a road infrastructure investment, over its entire useful life, is its safety performance. Safety performance has begun to take its place alongside operational performance (level of service), environmental, and financial performance.

An increased focus on the societal costs of road trauma has drawn attention to the proportion of injuries and fatalities attributable to designs in-service that, while perhaps conforming to prevailing minimum standards, are less than optimally safe. This recognition has led, in turn, to the concepts of design domain, road safety audit, and an explicit consideration of road safety at each step in the roadway life cycle—in other words, in planning, functional design, detail design, construction, operations, management, maintenance, and rehabilitation. Further, it has sharpened the focus of applied research and has highlighted the need for advances in the road safety body of knowledge to be considered in setting road transportation policy, and in maintaining the currency of standards.

A key outcome of this increasingly holistic view of road safety is the growing recognition that the safety implications of each step in the roadway life cycle are inextricably linked to those that preceded it and those that follow. Decisions taken at one stage in the process are constrained by those made previously, and those taken at subsequent stages are likely to pose constraints and/or have substantive impacts in the future.

6.1 BALANCING SAFETY AND MOBILITY

Some countermeasures to improve safety at a signalized intersection do so at the expense of mobility. In certain cases, the operational disbenefits may be too great. The traffic engineer needs to understand the tradeoff between safety and mobility.

Furthermore, mobility means more than just the movement of motor vehicles. It includes providing mobility for bicyclists, transit, and pedestrians of all abilities. Some mobility measures fall outside the range of tradeoffs. For example, ADA improvements required by law are not subject to traditional constraints of volume of use, cost, and warranting criteria. However, these improvements should be folded into the considerations in the evaluation and selection of improvements.

Access management is another example of the tradeoff between safety and mobility. Many intersections in commercial areas allow access via driveways within the functional area of the intersection, leading to unnecessary conflict. Closure or relocation of these driveways, the addition of medians, and the prohibition of certain turns can all improve safety at the expense of overall mobility. In older intersections, residential or commercial driveway access often remains within the intersection, once of little concern in the past, but now a major source of conflict due to the amount of traffic passing through.

Consideration of the competing goals of safety and mobility are needed for operations and safety of a signalized intersection. A typical problem traffic engineers face is the need to accommodate turning vehicles while recognizing when a particular movement may be too dangerous to allow or may have a significant impact on overall intersection operations. Using multiphase signal operation instead of one with only permissive left turns aids drivers in safely making left turns at the expense of lengthening the overall signal phase. Right turns may be allowed during the red phase at the expense of increasing pedestrian and bicycle collisions.

Some means of providing for turning traffic may do so without sacrificing mobility. Exclusive turn lanes, offset lanes, and channelization remove turning traffic from through lanes. Other solutions for accommodating left-turning vehicles may be signal coordination through the provision of gaps in oncoming traffic. At some intersections, the safety record, the operations, or the accessibility of the intersection to pedestrians and bicyclists may be so poor that an intersection redesign may be considered. This may mean realigning an approach, closing a leg, reducing curb radii or lane widths, using an innovative intersection design that allows for left turns at another location, or total grade separation.

The following sections will detail the four-part process for a safety evaluation of a signalized intersection.

- **Selection of an intersection:** The intersection is chosen using a selection tool.
- **Identification of potential problems:** Potential problems at the intersection are diagnosed using a detailed collision analysis, a site visit, and, if necessary, additional field studies. The end product is a set of problem statements that clearly shows cause and effect.
- **Identification of possible treatments:** Potential treatments are selected either through using part III of this guide as a reference or through other sources. Treatment are evaluated using either a quantitative or qualitative method of assessment.
- **Improvement plan development:** A plan is developed identifying the treatments, a schedule detailing their implementation, and the final plan for making the improvements.

6.2 SELECTION OF AN INTERSECTION

In selecting an intersection for a detailed safety analysis, the key questions are:

- What is the safety performance of the location in comparison with other similar locations?
- Is the safety performance at the location acceptable or not acceptable?

Based on what is observed at the intersection in terms of its overall safety experience, the traffic engineer can make a decision to proceed with a more detailed causal evaluation of the safety performance, as detailed later. If it appears that safety concerns are present, operational and design problems will likely also exist, given the relationships among poor level of service, design deficiencies, and a poor safety record. This section will discuss various statistical techniques for determining the relative safety of an individual location as compared to other locations and highlight the merits of each.

The collision history of a signalized intersection is the key indicator of its safety performance, and is the focus of the remainder of this section. Statistical techniques for evaluating the collision performance vary from the most basic to the complex. They may compare the safety performance of a single signalized intersection to another group of similar intersections, or serve as a screening tool for sifting through a large group of sites and determining which site has the most promise for improvement.

Many jurisdictions carrying out a review of safety at a signalized intersection will usually have a collision database which provides information on the location, time, severity, and other circumstances surrounding each collision reported by police or the parties involved. Collision data in this form can provide the traffic engineer with a quick assessment of safety at a location. However, the traffic engineer should keep the following in mind in the analysis of safety using collision data.

First, the engineer needs to be aware of what constitutes a collision in the available data. Collisions can be classified as reportable or nonreportable. Nonreportable collisions always involve no injury and usually involve vehicle damage below a certain threshold. Collisions may also be considered nonreportable if they take place on private property, as in a shopping mall parking lot or on a driveway. In other instances, they may involve a vehicle striking another parked vehicle and leaving the scene of the accident. The traffic engineer needs to be aware that nonreportable collisions may not show up in the collision database. If they are not recorded, their absence may possibly mask an underlying safety concern (figure 43).

The definition of a reportable collision varies from jurisdiction to jurisdiction. Usually, all collisions involving personal injury and those with damage exceeding a selected threshold may be classified as reportable. Occasionally the threshold dollar value used to classify property-damage-only collisions changes, and this may be a problem if the review period crosses through such a change and if property-damage-only collisions are being included in an analysis. This is one reason some jurisdictions will only consider injury and fatal collisions in their safety assessments. However, by doing so, they will have excluded a majority of collisions that actually occurred at a site, masking valuable information that may be useful at the diagnosis stage.



Photograph Credit: Synectics Transportation Consultants, Inc.

Figure 43. Exclusion of property-damage-only collisions (such as this one from an analysis) may mask valuable information.

Second, in some instances, a collision may be self-reported. In some jurisdictions, when the collision is property damage only, the police will not investigate, and the parties involved are required to report the collision on their own. Because information is self-reported and no information is collected on-scene by police, collisions may contain inaccurate or erroneous information. Because of the increased potential for low-quality information, detailed analysis involving self-reported collision information needs to be treated with caution.

Last, users of collision data should be aware of how the location of a collision is recorded. Adjacent intersections can be a convenient reference point for coding collisions. It is not uncommon to code a collision as occurring at an intersection when it actually occurred at a location nearby, such as an adjacent parking lot, a driveway, or immediately upstream or

downstream of the intersection (figure 44). The potential for error in coding the location of a collision should be understood. The traffic engineer should be aware of the procedures for coding locations and be satisfied that sufficient error checking of data has been done.



Photograph Credit: Synectics Transportation Consultants, Inc.

Figure 44. The potential for error in coding the location of a collision should be understood.

Once data are available, the most common method of assessing safety at a location is through comparing its collision history to other similar sites. If the traffic engineer is comparing the safety performance of a location to another set of locations, these need to be carefully thought through. At the very least, the other locations should also be signalized and have the same number of approaches as the site being examined; sites with different traffic control devices and layouts can be expected to have differing levels of safety. Surrounding land use will also have a significant effect on collision frequency, with intersections in urban areas having a different collision profile than intersections in rural areas. Finally, comparisons with sites that are located in other jurisdictions may be tainted by differing collision-reporting thresholds, enforcement, predominant land use, vehicle mix, road users, climatic conditions, or other unknown factors; results of such a comparison should be tempered with caution.

With these in mind, different methods of using collision data to assess safety are discussed in the following sections, highlighting their benefits and drawbacks. The different methods to be discussed are:

- Collision frequency.
- Collision rate.
- Combined collision frequency and rate.

- Equivalent property damage only method.
- Critical collision rate.
- Risk analysis methods.
- Safety performance functions.
- Empirical Bayes method.

6.2.1 Collision Frequency

Traditionally, traffic engineers used (and many still use) a frequency-based method of identifying and evaluating the safety of a site.⁽⁶⁴⁾ Past observed collision frequencies at a site may be used to compare and rank the site with collision frequencies at a group of similar locations. Many jurisdictions produce a top-10 list of the intersections producing the highest collision frequency in their jurisdictions and concentrate all of their efforts at reducing collisions at these sites. Recently, one insurance company released a list of the “worst” intersections in the United States, according to internal insurance data.⁽⁶⁵⁾

Collision frequency may also be used to screen candidate sites for improvements. The collision frequency at the site may be compared to the average collision frequency for a reference population to calculate a potential for improvement. However, relatively short periods of time, such as one year of collision data, should never be used as the basis for a safety intervention. Because collisions are relatively rare events, a high collision frequency in any given year at a particular intersection may be simply a random fluctuation around a much lower long-term average at the site. In the next year or series of years, the collision frequency may drop, without any safety intervention at all. This phenomenon is referred to as regression to the mean. Regression to the mean may be minimized by using data collected over a longer period of time, such as 3 years or more, when evaluating the site. Site selection based on multiple years of collision data will provide a truer picture of the collision profile of the intersection and avoid errors that can result from looking at collision history over a short period.

Apart from regression to the mean, there are several other disadvantages to using collision frequency as the sole means of evaluating safety at a location. First, a high collision frequency may not necessarily mean that a site is truly in need of safety improvement. It is known that sites with higher volumes will have a higher collision frequency than sites with lower volumes. Therefore, sites ranked simply by collision frequency will invariably end up with higher volume sites at the top of the list. Second, the method does not address the severity of collisions at the site. Failing to consider severity may result in the identification of sites with high numbers of minor collisions, while ignoring sites with fewer but more severe collisions. The approach results in a failure to identify sites at which the public has greater risk of injury or death.

6.2.2 Collision Rate

Collision rates are an improvement over measuring just collision frequency: They allow a measure of the risk road users face because rates consider exposure. Collision rates are calculated by dividing the collision frequency for a period of time by the estimated average annual daily traffic (AADT) of vehicles entering for all approaches in that time period. Collision rate provides an improved yardstick for comparison to other sites. As with collision frequency, a collision rate for a location undergoing a safety assessment may be compared to similar intersections (signalized, same number of legs, same range in AADT). The intersection may be ranked to produce a top-10 list, or a threshold value may be used above which a detailed safety analysis is warranted. Using a collision rate will account for the effect that volume has on collision frequency.

However, using a simple collision rate to screen locations has several disadvantages. First, using a collision rate to rank sites that have different volumes requires the assumption that collision frequency and volume have a linear relationship, but research suggests that this is not the case. Lower volume sites tend to experience a higher collision rate. Ignoring this fact means

that low volume sites may appear less safe than their higher volume counterparts. Second, collision rates, as with collision frequency, do not consider collision severity. Sites with a high collision rate may have relatively few casualty (fatal and injury) collisions. Last, as collision rates are calculated from collision frequency, which fluctuate around a long-term average and experience regression to the mean, a site might be ranked high on a list due to a recent period with an unusually higher number of collisions. If collision rates are being used to screen out candidate sites for safety improvements, it is recommended that a collision rate be calculated for a longer time period (3 to 5 years).

6.2.3 Combined Collision Frequency and Rate Method

Weaknesses in the collision frequency and collision rate methods of selecting candidate intersections for further collision analysis may be somewhat overcome by an approach that combines both methods. In this approach, intersections with both a high collision frequency and a high collision rate may be candidates for a more detailed safety diagnosis.

An example of this is presented in figure 45. The collision rate (per million entering vehicles) and the 5-year average collision frequency for 10 sites were plotted. Threshold values were selected to separate out the sites with the highest combined collision frequency and rates. Sites to be considered for further safety analysis were those with an average yearly collision frequency of greater than 30 collisions/year and a collision rate of 1.50 collisions per million vehicles entering the intersection. Based on this, one candidate intersection was selected. In the above example, the threshold values were arbitrarily chosen. The traffic engineer may also consider using a value that is twice the average collision frequency and rate as the threshold.

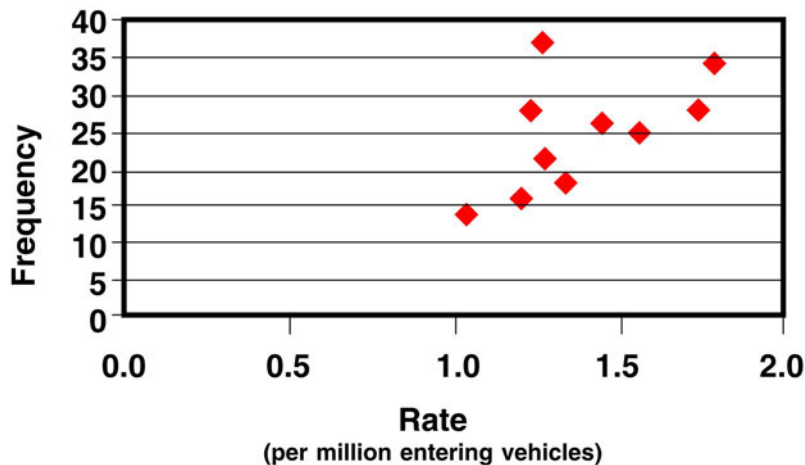


Figure 45. Selecting a candidate intersection using a combined collision frequency/collision rate method, where each diamond represents an intersection.

6.2.4 Collision Severity Method

In the above discussion, sites were considered for further analysis if the collision frequency, rate, or a combination of the two was particularly high. As identified, a weakness with these methods is that they do not consider the severity of the collisions involved. The collision severity method considers the distribution of collision severity for each site under consideration. A typical approach is through use of the Equivalent Property Damage Only (EPDO) index. It attaches greater importance, or weight, to collisions resulting in a serious injury or a fatality, lesser importance to collisions resulting in a moderate or slight injury, and the least importance to property-damage-only collisions. A weighting factor suggested in the 1999 ITE publication *Statistical Evaluation in Traffic Safety Studies* suggests the following severity breakdown (table

28), based on values used by the U.S Department of Transportation and the American Association of Motor Vehicle Administrators.⁽⁶⁴⁾

Table 28. Suggested weighting for collision severity method.

Severity	Weighting
Fatal collisions	9.5
Incapacitating injury (Type A Injury)—Any nonfatal injury that prevents the victim from walking, driving, or other normal activity	9.5
Non-incapacitating injury (Type B Injury)—Any evident injury that is not fatal or incapacitating	3.5
Possible injury (Type C Injury)—No visible injuries, but complaint of pain	3.5
PDO collision—Property damage only	1.0

Depending on local considerations, the above weighting system may be modified to reflect actual values in terms of cost, such as property damage, lost earnings, lost household production, medical costs, and workplace costs. A comparison with similar intersections (signalized, same number of legs, same range of AADT) may be done by calculating the EPDO index for similar sites to the one being considered. The EPDO index will explicitly consider the severity breakdown of collisions, providing greater weight to fatal and injury collisions over property-damage-only collisions. The traffic engineer should be aware, however, that because the severity of a collision is associated with higher speeds, signalized intersections on roads with a higher operating speed, such as in a rural location, will likely have a higher EPDO index than in an urban area. This may result in a bias that emphasizes higher speed locations. In addition, as with rankings based on collision frequency and rate, regression to the mean will be an issue if the study period chosen is short.

6.2.5 Critical Collision Rate

The critical collision rate method has been widely used among traffic engineers. It represents the expected collision rate of locations with similar characteristics (in this case, the same traffic control device). The critical rate is calculated based on the system-wide average collision rates for intersection or road sections of a similar characteristic. If the actual collision rate is greater than the critical rate, the deviation is probably not due to chance, but to the unfavorable characteristics of the intersection or road section. The method considers the collision rate of a location, allows for comparison with other similar sites, and incorporates a simple statistical test to determine whether the collision rate is significantly higher than expected. The statistical test is based on the assumption that collisions have a Poisson distribution.

The critical collision rate method is more robust than using collision frequency or collision rate alone, as it provides a means of statistically testing how different the collision rate is at a site when compared to a group of similar sites. The desired level of confidence may be varied depending on the preference of the user.

Disadvantages of using this method are that it still does not consider the severity of the collisions and assumes that traffic volume and collisions have a linear relationship. In addition, this approach does not consider regression to the mean.

6.2.6 Risk Analysis Methods

The concept of risk analysis involves the determination of collision risk using collision and volume data. Existing safety levels are evaluated at defined roadway locations within the jurisdiction. The collision risk is calculated at each specific site (local risk), across all sites of a specific group (area risk), and across the entire jurisdiction (global risk). Collisions of different severities (property damage only, injury, and fatal) are weighted according to the EPDO index. By

combining the results of the local, area, and global risk calculation, locations can be compared and ranked according to their relative risk and the potential for collision mitigation. Sites with the highest risk score would be candidate locations for further safety diagnostics.

Risk analysis methods are robust in that they consider the exposure (volume) and severity of the collisions occurring at the site. The local risk, area risk (risk among locations of a similar nature), and global risk (across the entire jurisdiction) are considered. However, they still assume that the relationship between collision frequency and volume is linear, and they do not consider regression to the mean.

6.2.7 Safety Performance Functions

A safety performance function (SPF) is an equation that presents the mathematical relationship between collision frequency and volume based on a group of intersections with similar characteristics (e.g., signalized, same number of legs). When collision frequency and volume are plotted, an equation can be developed that is represented by a line that is the best fit possible through the various points. Generally, SPFs demonstrate that the expected number of collisions increases as traffic volume increases, and an SPF is curvilinear rather than a straight line. Because the line that plots an SPF is curved, the rate (rise/run) varies continuously along the curve. An SPF typically shows that higher volume sites have a lower collision rate than do lower volume sites.

A simple example of an SPF is illustrated in figure 46. The blue points represent individual intersections with their respective average yearly collision frequency and AADTs. A curve can be drawn through the points representing the best fit. The green point above the curve represents an intersection that is performing worse than predicted.

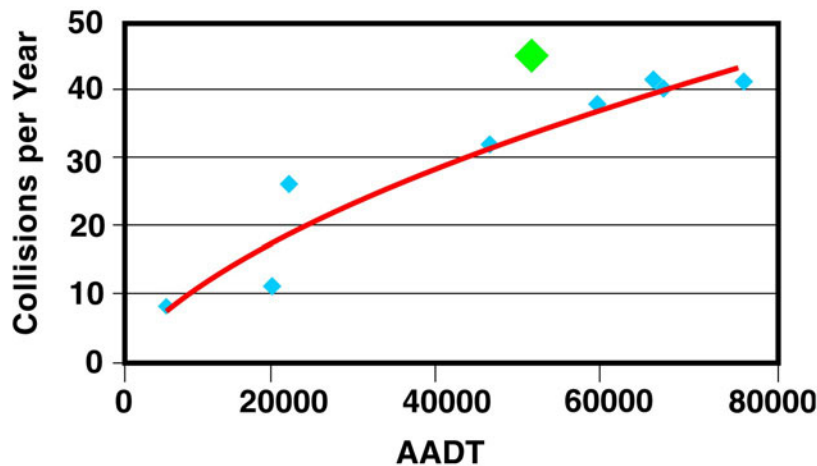


Figure 46. Example of SPF curve.

Advantages of using such a method are that the potential for safety improvement is more accurately calculated, and that it acknowledges that the relationship between collision frequency and volume is not a straightforward linear one. Disadvantages are that this method is relatively complex and still does not acknowledge the random variation of collisions.

6.2.8 Empirical Bayes Method

Each of the above methods only considers past collision history by either ranking and selecting a candidate location for further collision analysis, or determining whether a particular

intersection under study has a collision problem. Using collision history alone is flawed, because the frequency of collisions from year to year will randomly fluctuate about a long-term average (regression to the mean). Improved methods have evolved that identify high-risk sites that may benefit from remedial treatment(s), particularly the empirical Bayes (EB) method. Many jurisdictions are already employing the EB method.

The EB method calculates expected collision frequencies through a combination of observed and estimated collision frequencies. The estimated collision frequencies are derived through the development of an SPF curve. The SPF relates the level of safety of an intersection to traffic volume and other relevant geometric factors. The function estimates the expected number of collisions based on traffic volume and other characteristics; it is expressed in collisions/year for intersections.

The pivotal concept upon which contemporary methods for conducting proper road safety evaluations depend is the EB method. It is superior to traditional methods because it:

- Considers regression to the mean.
- Produces more stable and precise estimates of safety.
- Allows for estimates over time of expected collisions.

Although the development of SPFs is a relatively new area of road safety research, they have been implemented successfully for measuring the safety of road locations. Sites can be ranked to determine which is experiencing the highest number of collisions based on actual collision counts, and to determine its expected collision performance.

6.2.9 Conclusions

The above section has detailed various methods of assessing the safety of a location through consideration of its collision history and comparison with other similar sites. Care must be taken to ensure that the site is being compared with sites that should have a similar level of safety (i.e., sites with a traffic signal and the same number of legs). Simpler methods such as collision frequency and rate may provide a simple and quick way of diagnosing a potential safety problem, but should be used with caution. The traffic engineer may consider using the critical collision rate method or the collision severity method as these provide a more balanced assessment of safety. Developing an SPF, either on its own or for use in applying to the EB method, is a much more sophisticated method of evaluating safety at a location. A summary of the relative merits and drawbacks of each method is presented below in table 29.

Table 29. Common methods of assessing safety at a location.

Method	Advantages	Disadvantages
Collision frequency	<ul style="list-style-type: none"> • Simple to use • Easy for the public to understand 	<ul style="list-style-type: none"> • Biased toward high-volume sites • Does not consider exposure • Severity not considered • Regression to the mean not addressed
Collision rates	<ul style="list-style-type: none"> • Simple to use • Considers exposure 	<ul style="list-style-type: none"> • Biased toward low-volume sites • Requires volume data • Assumes collisions and volume have linear relationship • Severity not considered • Regression to the mean not addressed
Critical collision rate	<ul style="list-style-type: none"> • Relatively simple • Considers exposure • Applies a recognized statistical method 	<ul style="list-style-type: none"> • Requires volume data • Assumes collisions and volume have linear relationship • Severity not considered • Regression to the mean not addressed
Collision severity method	<ul style="list-style-type: none"> • Relatively simple • Considers exposure 	<ul style="list-style-type: none"> • Biased toward high-speed sites • Assumes collisions and volume have linear relationship • Regression to the mean not addressed
Risk analysis methods	<ul style="list-style-type: none"> • Accurate • Considers exposure and severity • Considers varying safety levels but locally, among a group of similar locations and across an entire jurisdiction 	<ul style="list-style-type: none"> • Requires volume data • Assumes collisions and volume have linear relationship • Regression to the mean not addressed
Safety performance functions	<ul style="list-style-type: none"> • More accurate • Considers exposure • Acknowledges that collisions and volume have a nonlinear relationship 	<ul style="list-style-type: none"> • Requires volume data • Regression to the mean not addressed • Labor intensive • Difficult for public to conceptualize
EB method	<ul style="list-style-type: none"> • Most accurate • Considers exposure • Acknowledges that collisions and volume have a nonlinear relationship • Addresses regression to the mean 	<ul style="list-style-type: none"> • Requires volume data • Difficult for public to conceptualize

6.3 IDENTIFICATION OF POTENTIAL PROBLEMS

The previous section discussed different tools that may be used to select a candidate intersection for a safety evaluation. At a certain point, the traffic engineer will conclude, based on past collision history, that there is a safety concern and a significant potential for safety improvement at the location in question. It should be noted that some traffic engineers may have completely bypassed the entire first step of this process (in determining a candidate intersection for safety improvements), because they have been asked to carry out a safety analysis of an intersection due to:

- Safety complaints or concerns raised by others (other departments, local politicians, the public).
- Planned reconstruction that would make it worthwhile to carry out a safety evaluation and improvements.
- Identified operational deficiencies.

This section will discuss how the traffic engineer may correctly diagnose what types of safety problems/issue may be present at a location. Diagnosis of a particular safety concern can then lead to appropriate treatment, as discussed in part III.

6.3.1 Safety Diagnosis

In conducting a safety diagnosis at a signalized intersection, the traffic engineer seeks to understand and identify causal factors of collisions within the functional boundaries of the intersection. All information gathered needs to be thoroughly reviewed and analyzed with the objective of identifying whether there exists one or more opportunities to improve safety at the location. The stages in carrying out a safety diagnosis are:

- Assemble collision data.
- Carry out a collision diagnostic analysis.
- Determine overrepresentation.
- Conduct a site visit.
- Conduct further studies, if necessary.
- Define problem statement(s).

Figure 47 shows the process described in this section.

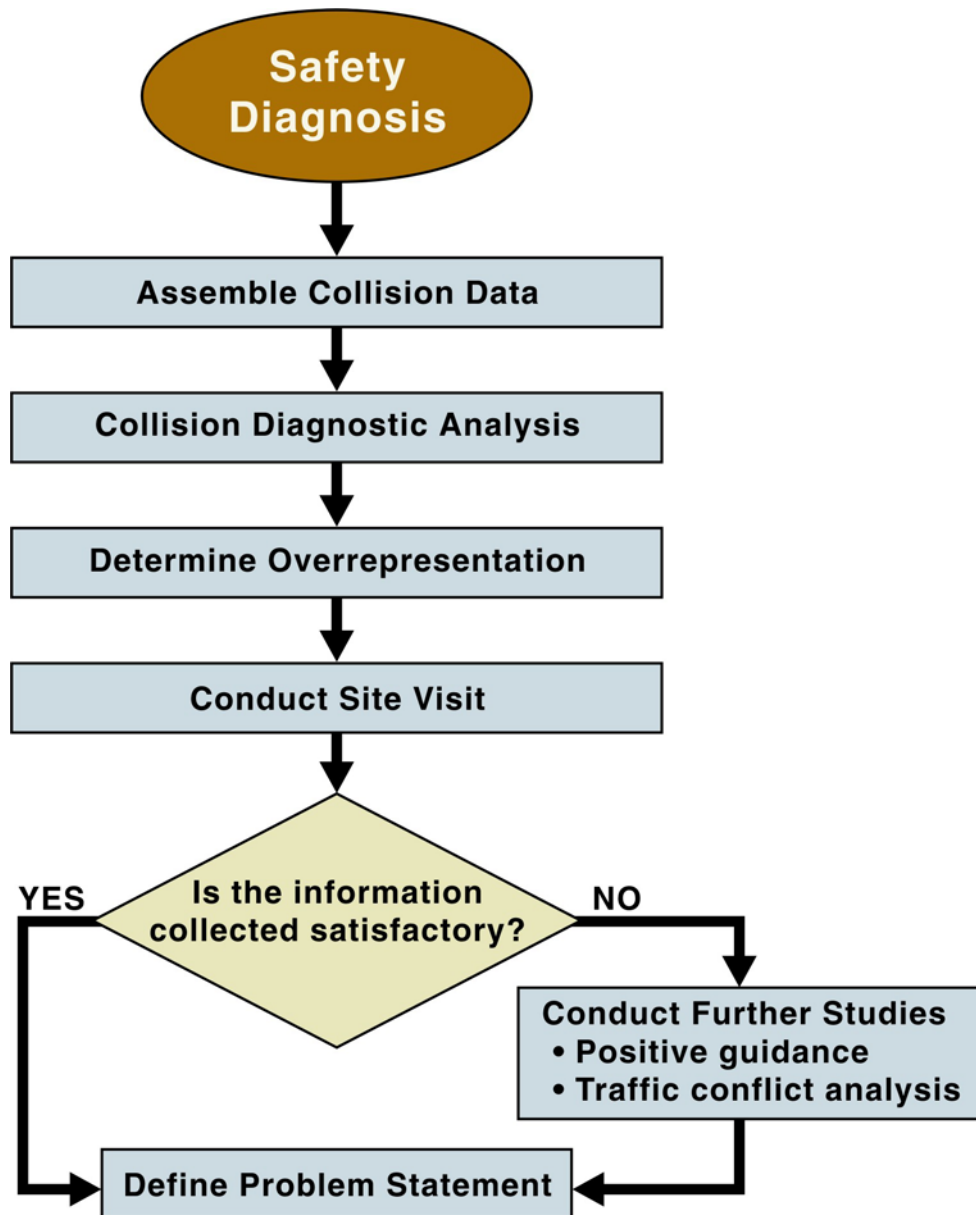
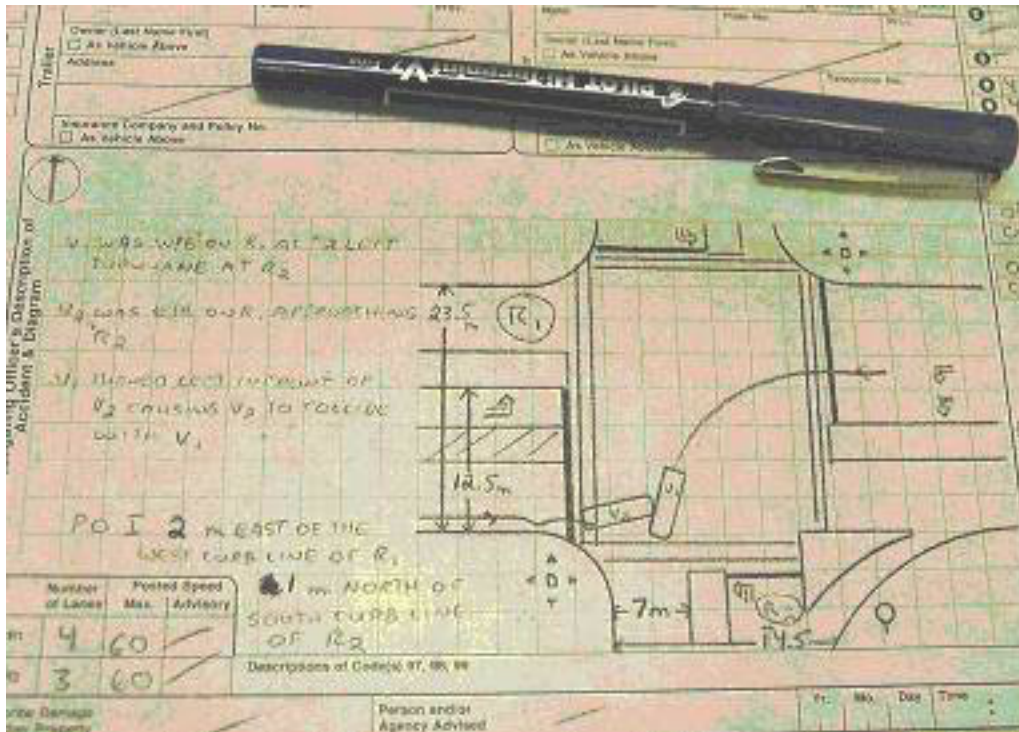


Figure 47. Identification of potential problems.

6.3.2 Assemble Collision Data

Collision data used for diagnosing safety at a signalized intersection should represent at least 3 years of collision data. It should include all collisions reported as occurring at or within the intersection’s sphere of influence. If available, the original police reports should be used to gather anecdotal comments written by police officers at the collision scene and firsthand accounts of the collisions based on involved parties and eyewitnesses (figure 48). Using either the original police reports or collision data taken from a database, a collision diagram should be prepared, providing a pictorial representation of the collision types, severity, movements, and involved approaches.



Photograph Credit: Synectics Transportation Consultants, Inc.

Figure 48. The original police collision report may contain valuable information regarding collisions that have occurred at the intersection.

All collisions occurring within the intersection should be included in the analysis, as well as those occurring immediately upstream and downstream. Collisions occurring further upstream may be included in the analysis, if it is found that operations at the intersection in question contributed to the collision. Rear-end collisions commonly occur well upstream of a signalized intersection due to vehicle queuing. Queuing may occur because of an operational deficiency at the signalized intersection.

The collision diagram will help the traffic engineer quickly ascertain:

- Whether the collisions are predominantly occurring on a particular approach or are systemic to the entire intersection.
- What movements appear to be the most problematic.
- Where and what type of injury and fatal collisions are occurring.

As highlighted earlier, the accuracy of safety diagnosis detailed in this chapter will depend on the quality of the collision data. Collision reporting systems may contain incorrect or missing information because:

- Collisions are not reported.
- Collisions are self-reported.
- Collisions are coded incorrectly.

Before beginning a detailed collision analysis, the traffic engineer should be aware of the strengths and weaknesses of collision data collected in the jurisdiction. Questions to consider are:

- Is there a reason not to trust information contained in any field of interest?

- Is information in this field collected consistently?
- What quality control is used on the information inputted?
- Is the information double-keyed to detect mistakes?
- Are logic checks built into the computer database (i.e., ensuring that snow is not reported in July, or an angle collision involving two vehicles traveling in the same direction)?

The above demonstrates the need to supplement any analysis of collisions in the office with field observations.

6.3.3 Analyze/Diagnose Collision Data

To correctly diagnose safety issues at an intersection, a detailed collision analysis is required, cataloguing the different characteristics of collisions at the intersection. The purpose of this analysis is to determine if any collision characteristics (e.g., collision type) at the study location are “abnormal” compared to those expected for signalized intersections having the same number of approaches elsewhere in the jurisdiction in question. By finding a collision characteristic that is abnormally elevated for a location, the traffic engineer can begin to pinpoint the cause of a collision.

The standard police collision report includes a number of collision descriptors that are collected by police and maintained in a database. These range from information on the driver, the vehicle, the road, and the environment. Many of these characteristics could help in determining causal factors; however, an exhaustive diagnosis of every collision descriptor may not be warranted to establish probable causes. As a primary review, collision characteristics that the traffic engineer should consider analyzing are:

- Collision distribution by season, day of week, and time of day.
- Collision severity.
- Collision type.
- Weather, light, and road surface conditions.

It is recommended that the traffic engineer prepare a table or set of tables that shows the typical collision profile of signalized intersection that is representative of the jurisdiction for each of the above-listed characteristics.

A number of statistical tests are available to determine whether the proportion of a characteristic found at a specific site is the same as that found in a group of similar sites. Identification of abnormal trends can lead toward possible solutions. To ensure that the determination of overrepresentation is valid, appropriate statistical techniques should be employed. The chi-square method is suggested.

Chi-Square Test

The chi-square test is a measure of the differences between measured and expected frequencies at location. The collision data at the subject location provide the measured frequency; the aggregate collision data from a large number of similar intersections provide the expected frequency. If the subject intersection displays a measured frequency that is greater than the expected frequency, then use of the chi-square test and reference to standard statistical tables will allow the analyst to determine whether the difference is likely a random variation or a real difference. Real differences, also called statistically significant differences, are an indication that the subject location has a site-specific deficiency that may be causing this trend.

The chi-square test can be calculated using equation 3.

$$\chi^2 = \frac{(x - pn)^2}{pn} + \frac{[(n - x) - n(1 - p)]^2}{n(1 - p)} \quad (3)$$

Where: χ^2 = Chi-square test value
 p = The average ratio for the collision type being investigated (i.e., 75 percent of collisions occurred during clear conditions)
 x = The frequency of the collision type being investigated
 n = The total number of collisions at the site

The chi-square test is not reliable when the expected frequency is less than 5. The expected frequency is determined by multiplying p and n . If $p*n$ is less than 5, then another statistical test is required. Confidence levels for the chi-square test are shown in table 30.

Table 30. Chi-square test values and corresponding confidence levels.

Chi-square Value	Confidence Level
> 7.88	99.5% confidence
> 6.63	99.0% confidence
> 5.02	97.5% confidence
> 3.84	95.0% confidence

An example of how the chi-square test may be used to determine overrepresentation is provided in the following example. A chi-square analysis was carried out to test whether collisions during wet road surface conditions are over-represented at a signalized intersection.

Given:

x = Wet road surface collisions at site (18)

n = Total collisions at site (50)

p = Percent of wet road surface collisions (25.4 percent) typically found at signalized intersections in the municipality.

Therefore:

$$\chi^2 = \frac{(18 - (0.254)50)^2}{0.254(50)} + \frac{[(50 - 18) - 50(1 - 0.254)]^2}{50(1 - 0.254)} = 2.96 \quad (4)$$

Chi-square values above 3.84 indicate a 95.0 percent confidence level in the result. In the example above, the chi-square value is 2.96, which is less than 3.84. Therefore, there is not enough evidence to suggest that wet road surface collisions are over-represented at the site.

6.3.4 Determine Overrepresentation

The traffic engineer may determine overrepresentation using either the chi-square or expected values method. The collision characteristics should be reviewed for over representation, through comparison with collision characteristic information representing the typical experience of a signalized intersection. Possible patterns the traffic engineer may encounter are highlighted below.

An examination of collision distribution by season, day of week, or time of day may be helpful in finding patterns that relate to the general travel patterns of road users passing through the intersection. Seasonal patterns, indicating a higher-than-expected proportion of collisions occurring during a particular time of year, may coincide with an influx of unfamiliar drivers to an area—as may be the case in resort areas and/or areas with a significant number of tourist

attractions. Day of week and time of day patterns should be examined. Morning/afternoon weekday overrepresentation may suggest collision patterns related to commuting traffic (coinciding with the morning and afternoon rush hours). A late night/early morning/weekend overrepresentation may suggest problems with drunk drivers.

Overrepresentation in collision severity will highlight a location that has an unusually high proportion of fatal and/or injury collisions. A higher proportion of fatal and/or injury collisions may suggest a problem with higher operating speeds.

Collision type, together with a collision diagram, can greatly aid the traffic engineer in diagnosis. A cluster of rear-end collisions on a particular approach may suggest a slippery pavement surface, a large turning volume inadequately serviced by existing lanes, or poor visibility of signals. Unfortunately, most collision reporting systems provide a very basic classification of collision type. For diagnosis purposes, this may not be especially helpful. For instance, one jurisdiction may group all collisions involving a turning movement together, whereas collisions involving left-turning vehicles being struck by an opposing vehicle may be of particular interest to the traffic engineer. The traffic engineer may wish to consider using more finely developed subcategories of collision types, such as detailed in figure 49, to aid in diagnosis. As well, the collision diagram will be an invaluable tool for isolating the combination of movements and/or approaches involved in the abnormal collision type.

Further analysis of such characteristics as vehicle type, driver/pedestrian condition, and/or apparent driver action may be required to provide further symptoms of the collision occurrences.

The end product of the above analysis will be a set of characteristics that is identified as being over-represented. A collision diagram, as discussed previously, may narrow the problem to a particular approach, and should at the very least assist in searching for the causes of the collisions and identifying patterns.

In some instances, however, no specific statistically significant overrepresentation will be found. This does not mean that the location is free of any safety concern. In these cases, the predominant collision type should be the focus of the problem statement (as confirmed through field observations).










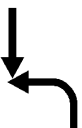












			
REAR END	HEAD ON	SIDESWIPE, SAME DIRECTION	SIDESWIPE, OPPOSITE DIRECTION
			
OVERTAKING	RIGHT TURN, REAR END	RIGHT TURN, ONCOMING	LEFT TURN, ONCOMING
			
LEFT TURN, REAR END	LEFT TURN, OPPOSING THRU	RIGHT ANGLE	RIGHT TURN, SIDESWIPE
			
THROUGH WITH RIGHT	LEFT TURN, SIDESWIPE	THROUGH WITH LEFT	LEFT AND RIGHT TURN, SIDESWIPE
			
SINGLE VEHICLE WITH PARKED CAR	SINGLE VEHICLE WITH OTHER THAN PARKED CAR	VEHICLE WITH PEDESTRIAN	VEHICLE WITH BICYCLE
			
BICYCLE WITH PEDESTRIAN	OTHER		

Figure 49. Possible taxonomy for collision type classification.

6.3.5 Conduct Site Visit(s)

To supplement the analysis and diagnosis using collision data, a site visit or series of site visits should be undertaken. Before initiating site visit(s), the study team should be aware of:

- Whether certain collision characteristics were overrepresented based on the analysis of collision overrepresentation.
- Which areas within the intersection's sphere of influence are showing unusual clusters of collisions.
- If available, what operational problems have been identified as part of the operational analysis.

The purpose of the site visit is to gather additional information that can aid in pinpointing potential underlying cause or causes of the abnormal collision patterns (figure 50). The site visit should be undertaken to:

- Observe driver/road user behavior during the following conditions:
 - Peak and off-peak periods.
 - Evening/night (as necessary).
 - Wet weather (as necessary).
 - Weekend and special events (as necessary).
- Photograph relevant features. Consideration may be given to using video recording to capture each intersection approach from the driver's perspective.
- Review the site from the perspective of all users, including motorists, pedestrians, and bicyclists. This includes observing motorist, bicyclist, and pedestrian circulation and identifying origins and destinations in the vicinity.
- Check for physical evidence of collisions or near-collisions, such as vehicle damage to street furniture, signs and other objects near the roadway, skid marks on the intersection approaches, tire marks on the shoulder or ground adjacent to the roadway.
- Conduct a conformance/consistency check: an assessment of signs and traffic control, markings, delineation, geometry and street furniture to ensure standard application and consistency and that all traffic control devices are in conformance with local, State, and Federal standards.

One of the key tasks the study team will wish to conduct during the site visit is a positive guidance review.⁽⁸⁾ A positive guidance review uses an indepth knowledge of human factors and the driving task to screen roadways for:

- Information deficiencies.
- Expectancy violations.
- Workload issues.



Photograph Credit: Synectics Transportation Consultants, Inc.

Figure 50. Conducting a site visit.

Each of the above may contribute to the occurrence of driver error and collisions.

Information deficiencies occur when information that the driver needs to carry out the driving task safely is missing. An example may be inadequate signage/pavement marking for a designated right-turn lane that traps drivers intending to proceed straight. Attempts to move over to the through lane can cause queuing and possible rear-end and sideswipe conflicts.

Expectancy violations occur when a driver encounters a traffic control or roadway design that conflicts with his or her expectations. The traffic engineer should structure expectancies about treatments at similar locations.⁽⁶⁶⁾ The key to effective expectancy structuring is uniformity and standardization. Standard devices that are inconsistently applied can create expectancy problems for drivers. A prime example of this is the use of a left-hand exit amidst a series of right-hand exits. Positive guidance seeks to address this expectancy violation through clearly communicating to the driver that a left-hand exit is ahead.

Workload issues occur when the driver is bombarded with too much information, increasing the likelihood of error. This may occur at an intersection with an abundance of signage, pavement markings, traffic signals, and pedestrian and bicycle activity. All of the above may be further complicated if the operating speed on the approaches is high, giving the driver even less time to sort through and comprehend what to do to get safely through the intersection and on to the intended destination. The traffic engineer should seek to reduce the complexity of the information the driver receives at the intersection or spread information by using advance signs.

Although positive guidance techniques are generally applied to the driving task, these concepts and tools can easily be considered from the perspective of all road users. Positive guidance is a holistic approach that treats the roadway, the vehicle, and the driver as a single,

integrated system. It recognizes drivers as the information gatherers and decisionmakers within the system and focuses attention on assuring that they get the information they need, when they need it, in a form they can understand, in time to make rapid, error-free decisions and take appropriate actions. When this occurs, the system functions most effectively, and the driving task is successfully accomplished. Creating and sustaining a supportive information environment on the roadway is the goal of positive guidance.

In conducting a positive guidance review, the analyst attempts to view the roadway through the eyes of an average driver, postulating what the driver's perceptions, interpretations, expectations, and actions might be. This is done to formulate theories and possible explanations regarding the cause or causes of previous or potential conflicts and/or collisions.

Positive guidance normally focuses on low-cost, information-oriented improvements that can be implemented quickly, either as solutions in and of themselves, or as interim improvements until a more definitive solution can be achieved. It may also identify the need for additional investigation, in the form of conventional engineering analysis, to support theories regarding the contributory causes of collisions, and to justify mitigation measures.

6.3.6 Deciding on Further Analysis

The outcome of the site visit, including a positive guidance review, should be a clear understanding of the safety problem occurring at the locations in terms of its underlying causes (field observations that explain the reason for that particular problem) and its link to any subsequent effects (an unusual pattern/high incidence of a specific collision group).

If the underlying cause of the safety problem is not entirely clear to the study team, treatments should not be selected until further field studies are carried out.

6.3.7 Conducting Further Studies

Further studies should provide a better understanding of the level of safety experienced by various users passing through the intersection by means of direct observational methods. The study team will need to spend an extended period on site observing traffic patterns and the interaction between the roadway/roadside elements and the drivers, pedestrians, and bicyclists.

The study team may choose to do a traffic conflict analysis that will provide a generic overview of driver, pedestrian, and bicyclist interactions over the course of a few days.⁽⁶⁷⁾ The traffic conflict analysis technique involves the systematic observation and reporting of traffic conflicts, or "near collisions," and an assessment of the degree of severity for each conflict. When two or more road users approach the same point in time and space, one or both must take evasive action to avoid a collision. At this point, one of two events may occur. If the evasive action is unsuccessful, then a collision occurs. If the evasive action is successful, a traffic conflict occurs. In general, the presence of a significant number of traffic conflicts indicates operational deficiencies and, possibly, collision potential.

The severity of the traffic conflict is measured by the summation of two scores assigned by the observer: the time-to-collision score and the risk-of-collision score. The time-to-collision score is a measure of the time before a collision would have occurred had no evasive action been taken, and is a function of the travel speeds, trajectories, and separation of the vehicles involved. The risk-of-collision score is a subjective measure of the collision potential and depends on the perceived control that the motorist had over the traffic conflict event. Factors such as maneuvering space and severity of the evasive action taken are considered in the assignment of the risk-of-collision score.

Upon completion of the traffic conflict analysis study, the various conflicts are drawn onto a diagram of the intersection, as with the collision diagram. Questions the traffic engineer may want to investigate are:

- Where in the intersection are the conflicts occurring?

- What movements appear to generate the most conflicts?
- Which movements appear to have the highest severity score?
- Are there any repeated patterns of driver making errors or disobeying/disregarding traffic control devices?

A full traffic conflict analysis for all movements at the intersection may not be necessary if a specific behavior is suspected as being a problem based on the site visit and/or collision analysis. Engineers may choose to study a specific behavior such as red light running, lane encroachments, failing to check blind spots while turning, failing to yield, stopping beyond the stop bar, blocking the crosswalk, blocking the intersection, illegal parking, or disobeying turn prohibitions.

The end result of the safety diagnosis (including the analysis of collision data, the site visits, and further studies, if necessary), will be a clear understanding of any abnormal collision patterns occurring at the site, along with the underlying and probable cause for these patterns.

6.3.8 Defining the Problem Statement

A set of one or more clear problem statements should be developed. The problem statement(s) are developed on the basis of the collision analysis (i.e. evidence of over representation among a collision subgrouping) and should be supported through the site visit and any further analysis. It should clearly state a probable “cause” and observed “effect.”

The problem statement helps clearly define safety concerns at the location. Circumstances associated with these safety concerns may be mentioned along with possible causal factors. The problem statement may be multifaceted and encompass the physical and/or operational attributes of the intersection, road user behavior and/or actions, environment and/or temporal conditions, as well as transitory or peripheral events. In many instances, the study team will identify several problems or issues.

Examples of problem statements are given in figure 51.

<p><u>Problem Statement #1</u></p> <p>Rear-end collisions and collisions occurring between 3 and 6 p.m. are overrepresented. The collision diagram shows that almost all of these occur on the westbound approach. Based on the site visit, the initial problem statement is that these are occurring due to:</p> <ul style="list-style-type: none"> • Lack of traffic signal visibility for westbound drivers. • Movement into and out of a commercial driveway on the near side of the intersection. • A polished pavement surface on this approach. • Glare from the afternoon sun.
<p><u>Problem Statement #2</u></p> <p>Fatal and injury collisions were overrepresented, and four fatal or injury collisions involved pedestrians. The collision diagram indicates that all occurred on the southwest corner of the intersection and are related to the right-turn lane channelization. Based on the site visit and subsequent further analysis, the initial problem statement is that these are occurring due to:</p> <ul style="list-style-type: none"> • The design of the right-turn channelization operating under YIELD control, which contributes to excessive driver speed. • Drivers failing to yield to pedestrians. • The presence of a bus shelter that partially blocks the view of the crosswalk.

Figure 51. Examples of problem statements.

6.4 IDENTIFICATION OF POSSIBLE TREATMENTS

The process described below and shown in figure 52 shows how possible treatments are initially identified, screened, and evaluated.

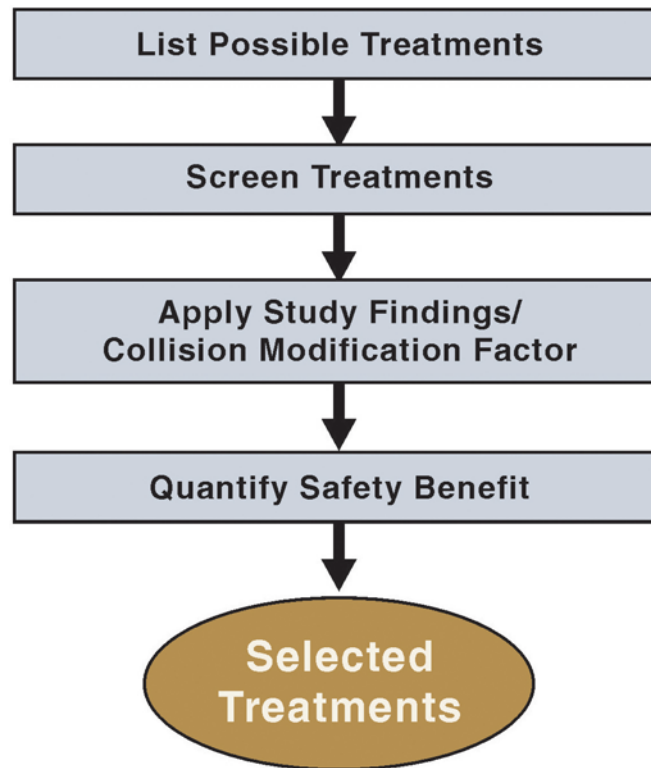


Figure 52. Identification of possible treatments.

6.4.1 List Possible Treatments

Using the problem statement(s) developed by the study team, possible treatments may now be identified. Possible treatments will be all measures listed that are likely to decrease the frequency or severity of collisions identified as exhibiting an abnormal pattern (overrepresentation).

In part III of this guide, the reader will find treatments organized into five broad groups:

- System-wide treatments (chapter 8).
- Intersection-wide treatments (chapter 9).
- Alternative intersection treatments (chapter 10).
- Approach treatments (chapter 11).
- Individual movement treatments (chapter 12).

For each treatment, there are references to possible collision groups that are likely to be positively affected through a treatment's implementation. At signalized intersections, the four collisions groups most commonly identified as a cause for concern are:

- Rear-end collisions.

- Angle collisions.
- Left-turn collisions.
- Collisions involving pedestrians and bicyclists.

Table 31 presents possible causes and treatments for each of these types, along with the appropriate chapter. Note that treatments involving enforcement and education are not discussed in part III of this report.

The material presented here by no means represents the limitation of possible treatments. It gives some indication of the range of options that could be selected, but is not fully comprehensive. It is not possible to develop a complete list of all potential collision treatments, because new tools and techniques for improvement traffic safety are constantly being developed and adopted. It is important that the study team not limit itself to existing lists or tables of treatments. The team should consider a wide range of treatments (including those based on local practice) that may be beneficial, particularly when the collision pattern identified represents a unique situation.

Over the course of the above collision diagnostic analysis, site visits, and field analysis, the traffic engineer may have identified treatments that are of little cost and without question beneficial to improving safety at the intersection. Such treatments may relate to repairing sidewalks, removing sight obstructions, reapplying faded pavement markings, and relocating or adding new signs. These may be implemented without going through the process described below.

Table 31. Collision types commonly identified, possible causes, and associated treatments.

Collision Type	Possible Cause	Possible Treatment Group (Chapter)
Rear-end collisions	<ul style="list-style-type: none"> Sudden and unexpected slowing or stopping when motorists make left turns in and out of driveways along corridor 	<ul style="list-style-type: none"> Median improvements (chapter 8)
	<ul style="list-style-type: none"> Sudden and unexpected slowing or stopping when motorists make right turns in and out of driveways along corridor 	<ul style="list-style-type: none"> Access management (chapter 8)
	<ul style="list-style-type: none"> Too much slowing and stopping along corridor due to turbulent traffic flow 	<ul style="list-style-type: none"> Signal spacing and coordination improvement (chapter 9)
	<ul style="list-style-type: none"> Too much slowing and stopping along intersection approaches due to traffic-control issues 	<ul style="list-style-type: none"> Traffic control improvement (chapter 9)
	<ul style="list-style-type: none"> Drivers caught in intersection during red phase due to inadequate traffic control or inadequate clearance interval 	<ul style="list-style-type: none"> Enforcement of red light running and aggressive driving
	<ul style="list-style-type: none"> Traffic signal not conspicuous or visible to approaching drivers, causing sudden and unexpected slowing or stopping movements 	
	<ul style="list-style-type: none"> Drivers unable to stop in time due to road surface 	<ul style="list-style-type: none"> Pavement / crosswalk improvements (chapter 9)
Angle collisions	<ul style="list-style-type: none"> Sudden and unexpected slowing or stopping due to inadequate intersection capacity 	<ul style="list-style-type: none"> Individual movement treatments (chapter 12) Enforcement of aggressive driving
	<ul style="list-style-type: none"> Drivers caught in intersection during red phase due to inadequate traffic control or inadequate clearance interval 	<ul style="list-style-type: none"> Traffic control improvement (chapter 9)
	<ul style="list-style-type: none"> Traffic signal not conspicuous or visible to approaching drivers, causing drivers to get caught in intersection during red phase 	<ul style="list-style-type: none"> Approach improvement (chapter 11)
Left-turn collisions	<ul style="list-style-type: none"> Drivers caught in intersection during red phase due to inadequate warning/inability to stop 	<ul style="list-style-type: none"> Enforcement of red light running and aggressive driving
	<ul style="list-style-type: none"> Intersection cannot accommodate left-turn movements safely 	<ul style="list-style-type: none"> Alternative intersection treatments (chapter 10) Individual movement treatments (chapter 12)
Collisions or conflicts involving bicyclists and pedestrians	<ul style="list-style-type: none"> Either the intersection cannot safely accommodate the pedestrians and/or bicyclists, or motorists are failing to see or yield to their movements 	<ul style="list-style-type: none"> Pedestrian, bicycle, and/or transit improvements (chapter 9) Enforcement of aggressive driving

6.4.2 Screen Treatments

The study team likely will generate a long list of treatments that may have been identified in this guide, based on local practice or representative of a unique situation identified at the intersection through the collision analysis, site visits, and subsequent studies carried out in the field. To narrow the options, the study team may consider screening the treatments. One method of screening proposed treatments is to develop a matrix where each treatment is given a score within different categories, based on the consensus among study team members. The individual score categories may be as follows:

- **Overall Feasibility:** How feasible would it be to implement the treatment? Would it involve a significant amount of work, time and/or coordination with police, maintenance staff, transportation planners, or the public? Straightforward treatments get positive scores. Difficult-to-implement treatments get negative scores.
- **Installation Cost:** What would be the significance of the cost of implementing the treatment? Treatment involving little or no capital costs score positive. Treatments involving a significant investment in capital costs score negative.
- **Maintenance Cost:** What would be the significant of the cost of the upkeep of the treatment? Treatments that would decrease maintenance requirements/efforts score positive. Treatments that would increase maintenance requirements/efforts score negative.
- **Reduction in Collision Frequency:** Is the treatment expected to bring about a reduction in collision of the particular type identified? Treatments that would reduce such collision frequency score positive. Treatments that would increase that collision frequency score negative.
- **Reduction in Collision Severity:** Is the treatment expected to bring about a reduction in severity in the collision type identified? Treatments that would reduce severity score positive. Treatments that would increase severity score negative.
- **Impact on Traffic Operations:** Is the treatment expected to improve the flow of traffic within the intersection influence area? Treatments that would improve traffic operations score positive. Treatments that would degrade traffic operations score negative.
- **Consistency with Local Practice:** Is the treatment consistent with local practice? Treatments that are familiar to the public and have known benefits score positive. Treatments that are unfamiliar and are largely untested score negative.

Scoring each treatment allows the study team to quickly determine which treatments are expected to have a positive or negative effect on the intersection. The long list of potential treatments then can be reduced to a short list of viable treatments. Based on a threshold score decided upon among the study team, the treatments may then be screened and those scoring poorly may be discarded.

The ability to evaluate the safety impacts of a treatment is paramount to implementing an intersection improvement plan. Information is needed on whether the treatment under consideration is effective in reducing collisions. Most treatments proposed in part III of this guide have some published material that provides a quantitative estimate of effectiveness. For other treatments in part III, no research was found that provided any quantifiable estimate of safety benefits. Before any further consideration as to be applicability of a treatment can occur, the study team will need to decide whether they have a quantifiable estimate of the expected results of a treatment available. If they do, they can proceed with the steps described below. If not, they should carefully consider whether the treatment should be implemented.

6.4.3 Selecting a Collision Modification Factor or Study Finding

Generally speaking, quantitative estimates of the effectiveness of a treatment may be developed from:

- Collision (or crash) modification factors (CMF).
- Study findings.

CMF is a term that is widely used in road safety engineering. It may also be referred to as an accident modification factor (AMF). A CMF is the ratio of expected collision frequency at a location with a treatment divided by the expected collision frequency at the location without the

treatment. If the expected collision frequency with a treatment is 9 and the expected collision frequency without the treatment is 12, then the CMF is $9/12 = 0.75$.

Traffic engineers should be careful not to confuse the term CMF with CRF, which stands for collision reduction factors. A CRF is the portion of collisions that will be reduced if a treatment is applied. The CRF is easily determined, being 1 minus the CMF value. Using the above example, if the CMF is 0.75, then the CRF is $1 - 0.75 = 0.25$. The expected reduction in collisions that would come from application of the treatment would be $0.25 \times 12 = 3$.

Many State jurisdictions have developed reference lists of CMFs to help them choose an appropriate treatment for an intersection improvement plan. In some cases, very little or no documentation exists showing how these CMFs were derived. Some State authorities are currently using CMFs developed from in-house projects; others use CMFs developed by other transportation authorities or based on published research.

Part III of this guide reports study findings taken from a variety of sources. These findings either reported a change in collision frequency or rate as part of a cross-sectional study, a before-after study, or by more sophisticated methods. Each study finding was reviewed in terms of:

- The reasonableness of the values presented.
- The year of the study.
- The general integrity of the study in terms of collision data used, methodology, and sample size.
- The country of origin.

In general, findings were discarded that appeared unreasonable, were outdated, used overly simplistic methods, or were based on research carried out outside of North America, unless no other finding was available for the treatment in question. The results are presented as the expected change in collision frequency (and are expressed as a percentage). A study finding of 50 percent means that there is expected to be a reduction of 50 percent in the number of collisions occurring after the application of the treatment the study finding describes. Each CMF or study finding in part III of this guide is referenced. In applying a CMF or finding was to determine the expected outcome of implementing a treatment, the user is urged to review the source material from which the CMF or study finding was derived, to determine its applicability to his or her specific project. Readers may wish to use their own CMFs or the results of another study finding known to them, should they believe that it is more accurate or better reflects conditions occurring at the location in question.

6.4.4 Quantify Safety Benefit

The target benefit of any treatment is a reduction in the frequency or severity of collisions. Assumptions regarding potential benefit of a treatment must be realistic. The collision frequency (or collision frequency of a specific group of collisions) cannot be driven below zero. To quantify the safety benefit of implementing a treatment, the estimated collision reduction that will be connected with the implementation of the treatment must be determined. If a treatment is successful in eliminating or reducing the severity of collisions that would have been expected without the treatment, then the benefits can be attributed to the treatment.

When two treatments are considered and each has a quantifiable safety benefit, a common way to express the combined safety benefit is to multiply both values. For example, treatment A might have a CMF of 0.90, and treatment B might have a CMF of 0.80. Combined, the two treatments should have an expected benefit of (CMF A (0.90) x CMF B (0.80)) of 0.72.

Usually, treatments can only be expected to be successful when applied to a particular target group of collisions. For example, the installation of protected left-turn phasing on one approach should substantially reduce left-turn collisions involving that particular approach, but cannot be expected to affect left-turn collisions on any other approach.

Treatments can also have undesirable effects that need to be considered in evaluating their overall benefit. For example, the installation of right-turn channelization may reduce collisions involving right-turning vehicles and possibly rear-end collisions on a particular approach, but may increase collisions involving pedestrians. If the treatment is to be applied, both positive and negative consequences need to be considered.

The potential collision reduction from a treatment is determined by multiplying the expected number of collisions by the percentage reduction that the treatment is expected to have. The expected number of collisions (total or by severity) may be assumed to be the same as in the period before the treatment, but a much more refined method would be to develop an estimate of the expected number of collisions based on SPF curves or the EB method.

Placing an economic value on collisions, by severity, is a common practice in quantifying the safety benefits of a treatment. There are several ways of arriving at societal cost (such figures are available from FHWA and various State transportation agencies).

Calculating the safety benefit of a treatment means multiplying the expected collision reduction by severity (property damage, injury, and fatal) by applicable society cost figures. A means of expressing the calculation of the safety benefit of the treatment is as follows:

$$\text{Safety Benefit (\$)} = \Delta n_{PDO} \times C_{PDO} + \Delta n_I \times C_I + \Delta n_F \times C_F \quad (5)$$

- Where:
- Δn_{PDO} = Expected reduction in property-damage-only collisions
 - C_{PDO} = Societal costs of property-damage-only collisions
 - Δn_I = Expected reduction in injury collisions
 - C_I = Societal costs of injury collisions
 - Δn_F = Expected reduction in fatal collisions
 - C_F = Societal costs of fatal collisions

The end result of the above calculations will be a list of treatments with associated societal benefits.

As an example: A multilane signalized intersection has been diagnosed as having a safety problem associated with a particular approach. Adding a right-turn lane is being considered as a possible treatment. Calculation of the safety benefit involves determining the product of the yearly average number of collisions, the societal benefit, and the estimated reduction in collisions grouped by collision type (table 32). The total societal benefit is calculated to be \$66,000.

Table 32. Example calculation of safety benefit of adding a right-turn lane.

Collision Type	5-Year Total Before Treatment	Yearly Average Before Treatment	Estimated Reduction Due to Treatment	Estimated Yearly Average After Treatment	Unit Societal Benefit	Estimated Yearly Benefit of Treatment
Fatal	0	0.00	40%	0.00	\$3,500,000	\$0
Injury	8	1.60	40%	0.64	\$100,000	\$64,000
PDO	25	5.00	10%	0.50	\$4,000	\$2,000
Total						\$66,000

Source for estimated reductions: (68)

In certain situations, no CMF or study findings will be available for a particular treatment. A qualitative assessment of safety risk at the considered treatment may be undertaken. Safety risk is used to determine the relative severity of each issue or problem, and is a function of the exposure of the different road users; the probability of a crash occurring under the geometric, environmental, and traffic characteristics; and the likely consequences of a crash. This concept is further explored in a 2002 paper by de Leur and Sayed.⁽⁶⁹⁾

Exposure. Exposure typically is measured in terms of traffic volume, including passenger vehicles, trucks, pedestrians, and bicyclists. Exposure is also expressed in distance traveled or in time spent on the roadway. With increased exposure, the more a person is involved in road traffic, the more likely it is that the person will be involved in a collision.

Probability. The probability of a crash measures the degree of certainty that a particular event would occur. Probability is dependent upon design parameters, traffic operations, time periods, environmental conditions, and traffic characteristics.

Consequence. The consequence refers to the severity of an injury sustained by a person involved in an accident. Severity is measured in terms of property damage collisions, injuries, or fatalities.

Using the approach described above, consideration may be given to treatments having no quantifiable safety benefit. Such treatments should be considered with caution, however, as described below.

6.4.5 Selected Treatment(s)

As a result of the above, the traffic engineer will have selected a set of treatments, some having an associated dollar value indicating the societal benefit in terms of collision avoided. These treatments should all be carried forward for the improvement plan development discussed in the next section.

6.5 IMPROVEMENT PLAN DEVELOPMENT

The stages in the improvement plan development are:

- Creating an implementation schedule.
- Producing a final plan.

Findings from the safety analysis should be carried forward in coordination with the findings of the operational analysis; the two components together can be carried forward into an improvement plan.

Treatments that have quantifiable safety benefits, based on the results of the numerical analysis, may be considered with some degree of confidence using a cost-benefit analysis. The cost of implementing the treatment should be considered in terms of construction, operating, and maintenance costs, if applicable, and then compared to the benefits in terms of the societal cost of collisions avoided.

A treatment with no quantifiable safety benefit also can be evaluated in a cost-benefit analysis, but the results should be treated with caution. The study team should recognize the reduced confidence in a treatment's ability to effect an improvement in safety. The following questions may help the team decide whether to implement such a treatment:

- Does the study team believe that the treatment would be associated with a significant improvement in safety?
- Can the treatment be implemented with relatively few (or no) construction, maintenance, and operating costs?
- Would the treatment significantly benefit vulnerable road users?
- Do other incidental benefits result from implementing the treatment?

In developing an improvement plan, the study team will need to refer to the findings of the operational analysis. The operational analysis provides recommendations that address the identified operational problems occurring at the intersection. These recommendations may be in agreement with the recommended treatments of the safety analysis.

CHAPTER 7

OPERATIONAL ANALYSIS METHODS

TABLE OF CONTENTS

7.0	OPERATIONAL ANALYSIS METHODS	145
7.1	Operational Measures of Effectiveness	146
7.1.1	Motor Vehicle Capacity and Volume-to-Capacity Ratio	147
7.1.2	Motor Vehicle Delay and Level of Service	148
7.1.3	Motor Vehicle Queue	148
7.1.4	Transit Level of Service	149
7.1.5	Bicycle Level of Service	149
7.1.6	Pedestrian Level of Service	150
7.2	Traffic Operations Elements	151
7.2.1	Traffic Volume Characteristics	151
7.2.2	Intersection Geometry	152
7.2.3	Signal Timing	152
7.3	Rules of Thumb for Sizing an Intersection	153
7.4	Critical Movement Analysis	154
7.5	HCM Operational Procedure for Signalized Intersections	157
7.6	Arterial and Network Signal Timing Models	157
7.7	Microscopic Simulation Models	158

LIST OF FIGURES

<u>Figure</u>		<u>Page</u>
53	Still reproduction of a graphic from an animated traffic operations model	146
54	Overview of intersection traffic analysis models	147
55	Pedestrian LOS based on cycle length and minimum effective pedestrian green time	151
56	Graphical summary of the Quick Estimation Method	155

LIST OF TABLES

<u>Table</u>		<u>Page</u>
33	Motor vehicle LOS thresholds at signalized intersections	148
34	Bicycle LOS thresholds at signalized intersections	150
35	Pedestrian LOS thresholds at signalized intersections	150
36	Planning-level guidelines for sizing an intersection	153
37	V/C ratio threshold descriptions for the Quick Estimation Method	156

7. OPERATIONAL ANALYSIS METHODS

Chapter 6 described tools that can be used to assess the safety performance at a signalized intersection. Evaluating a candidate treatment usually requires that its performance also be assessed from the perspective of traffic operations. This chapter will, therefore, focus on measures for assessing operational performance and computational procedures used to determine specific values for those measures.

The relationships between safety performance and operational performance are difficult to define in general terms. Some intersection treatments that would improve safety might also improve operational performance, but others might diminish operational performance. Furthermore, the nature of safety and operational measures makes them difficult to combine in a way that would represent both perspectives.

Operational performance measures tend to be fewer in number and more easily related to site-specific conditions than are safety performance measures. The computations themselves are more amenable to deterministic models, and a wide variety of such models, mostly software based, is available. Selecting a model for a specific purpose is generally based on the tradeoff between the difficulty of applying the model and the required degree of accuracy and confidence in the results. The degree of application difficulty is reflected in the required amount of site-specific data as well as the level of personnel time and training needed to apply the model and to interpret the results.

Recent user interface enhancements in the more advanced traffic model software products have made the products much easier to apply; some can generate animated graphics displays depicting the movement of individual vehicles and pedestrians in an intersection (an example is in figure 53). An increasing trend toward the use and acceptance of advanced traffic modeling techniques has occurred as a result of these enhancements.

While the range of operational performance models is more or less continuous, it will be categorized into the following four analysis levels for purposes of this discussion:

- Rules of thumb for intersection sizing.
- Critical movement analysis.
- The *HCM 2000* operational analysis procedure.⁽²⁾
- Arterial signal timing design and evaluation models.
- Microscopic simulation models.

These levels are listed in order of complexity and application difficulty, from least to greatest. They are summarized in figure 54 in terms of their inputs, outputs and the data that may flow between them. Each analysis levels will be discussed separately.

The process for evaluating the operational performance of an intersection remains unchanged regardless of the analysis level and the issues at hand. The analysis should begin at the highest level and should continue to the next level of detail until the key operations-related issues and concerns have been addressed in sufficient detail.

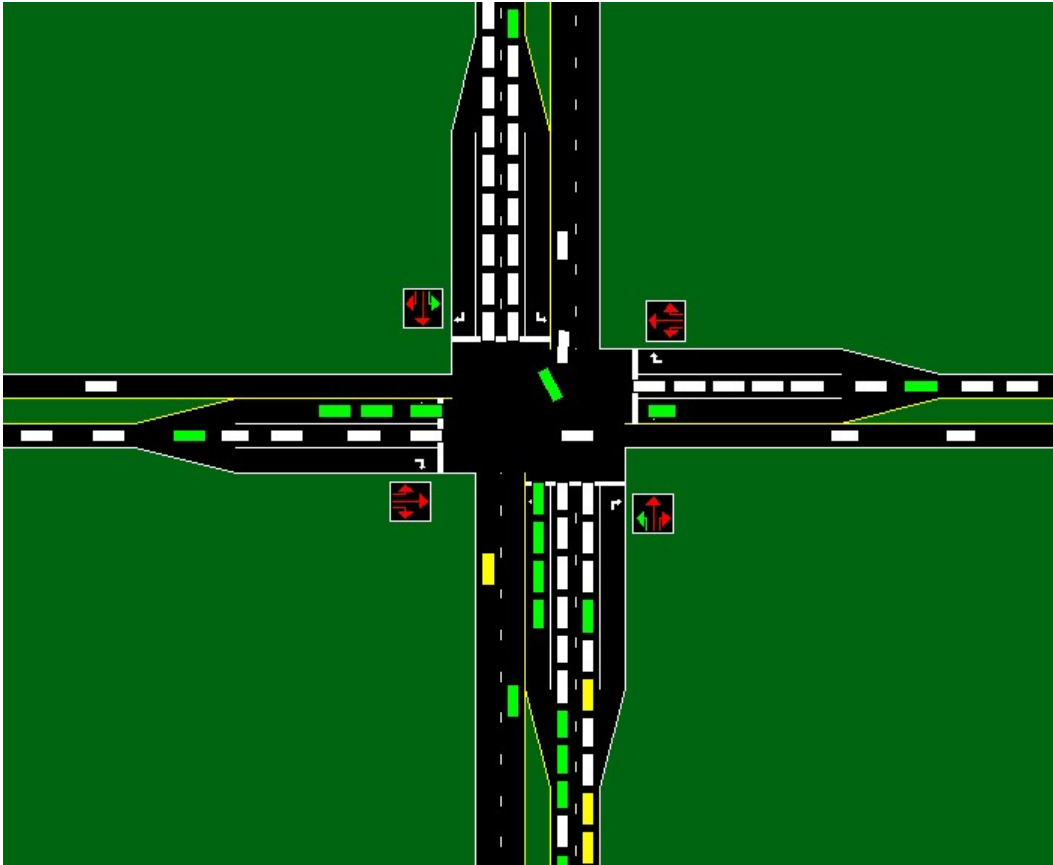


Figure 53. Still reproduction of a graphic from an animated traffic operations model.

The ability to measure, evaluate, and forecast traffic operations is a fundamental element of effectively diagnosing problems and selecting appropriate treatments for signalized intersections. A traffic operations analysis should describe how well an intersection accommodates demand for all user groups. Traffic operations analysis can be used at a high level to size a facility and at a refined level to develop signal timing plans. This section describes key elements of signalized intersection operations and provides guidance for evaluating results.

7.1 OPERATIONAL MEASURES OF EFFECTIVENESS

Three measures of effectiveness are commonly used to evaluate signalized intersection operations:

- Capacity and volume-to-capacity ratio.
- Delay.
- Queue.

The *HCM 2000* estimates measures of effectiveness by lane group.⁽²⁾ A lane group includes a movement or movements that share a common stop bar. Exclusive turn lanes are generally treated as individual lane groups (i.e., right-turn-only lane). Shared movements (such as one or more through lanes that are also serving right turns) are represented as a single lane group. Lane group results can be aggregated by approach and for an entire intersection.

Other international capacity analysis procedures, including the Australian-based SIDRA software analysis package,⁽⁷⁰⁾ the Canadian capacity guide,⁽⁷¹⁾ and the Swedish capacity guide,⁽⁷²⁾ provide methods for estimating performance measures at the individual lane level. These procedures implicitly assume an equal volume-to-capacity (v/c) ratio across “choice lanes” (i.e., a through and a through/right-turn lane).

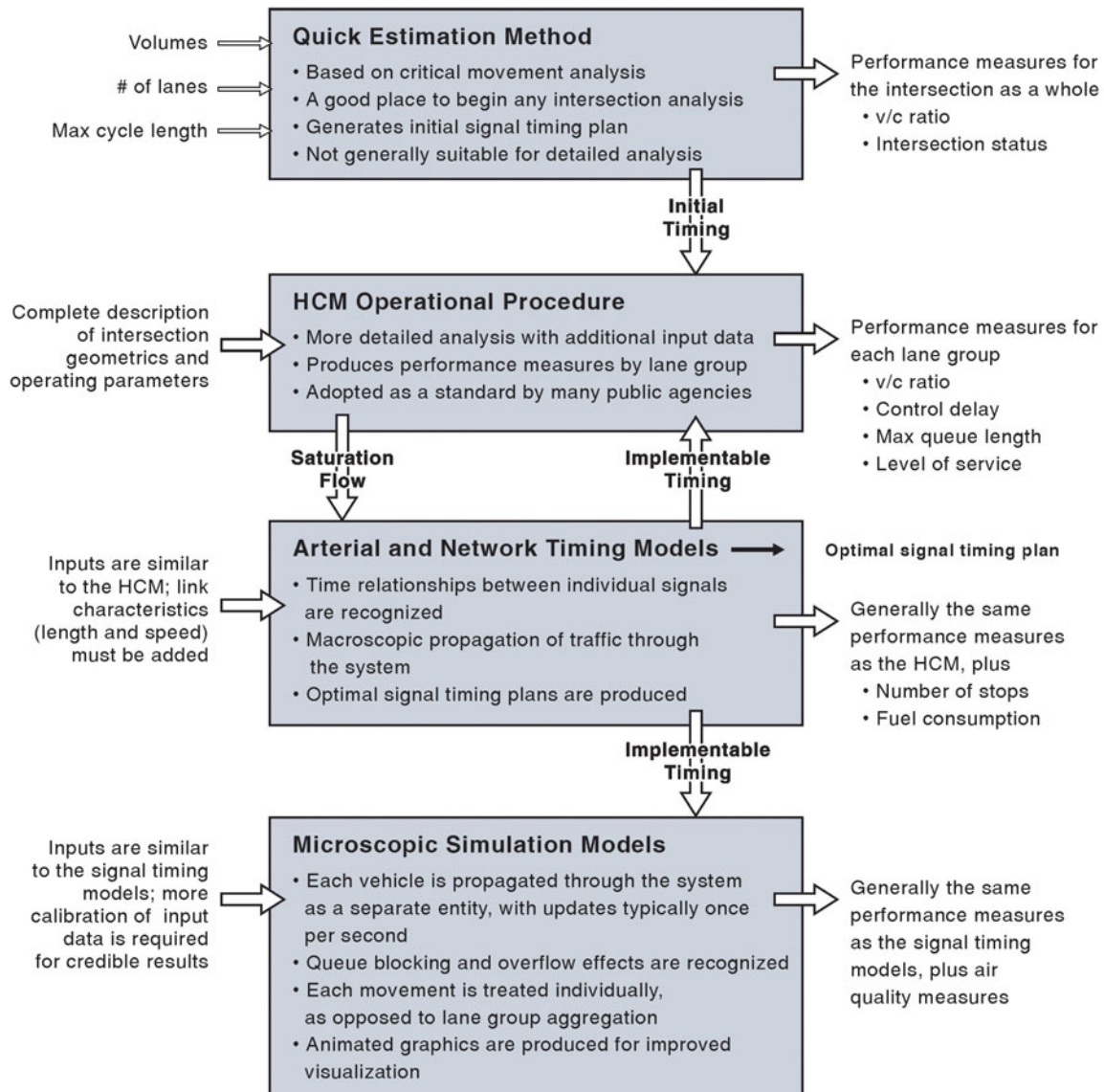


Figure 54. Overview of intersection traffic analysis models.

7.1.1 Motor Vehicle Capacity and Volume-to-Capacity Ratio

Capacity is defined as the maximum rate at which vehicles can pass through a given point in an hour under prevailing conditions; it is often estimated based on assumed values for saturation flow. Capacity accounts for roadway conditions such as the number and width of lanes, grades, and lane use allocations, as well as signalization conditions. Under the *HCM 2000* procedure, intersection capacity is measured for critical lane groups (those lane groups that requires the most amount of green time). Intersection volume-to-capacity ratios are based on critical lane

groups; noncritical lane groups do not constrain the operations of a traffic signal. Rules for determining critical lane groups are further explained in *HCM 2000*.

Research conducted as part of the 1985 HCM showed that the capacity for the critical lanes at a signalized intersection was approximately 1,400 vehicles per hour.⁽⁷³⁾ This capacity is a planning-level estimate that incorporates the effects of loss time and typical saturation flow rates. Studies conducted in the State of Maryland have shown that signalized intersections in urbanized areas have critical lane volumes upwards of 1,800 vehicles per hour.⁽⁷⁴⁾

The v/c ratio, also referred to as degree of saturation, represents the sufficiency of an intersection to accommodate the vehicular demand. A v/c ratio less than 0.85 generally indicates that adequate capacity is available and vehicles are not expected to experience significant queues and delays. As the v/c ratio approaches 1.0, traffic flow may become unstable, and delay and queuing conditions may occur. Once the demand exceeds the capacity (a v/c ratio greater than 1.0), traffic flow is unstable and excessive delay and queuing is expected. Under these conditions, vehicles may require more than one signal cycle to pass through the intersection (known as a cycle failure). For design purposes, a v/c ratio between 0.85 and 0.95 generally is used for the peak hour of the horizon year (generally 20 years out). Overdesigning for an intersection should be avoided due to negative impacts to pedestrians associated with wider street crossings, the potential for speeding, land use impacts, and cost.

7.1.2 Motor Vehicle Delay and Level of Service

Delay is defined in *HCM 2000* as “the additional travel time experienced by a driver, passenger, or pedestrian.”⁽²⁾ The signalized intersection chapter (chapter 16) of the HCM provides equations for calculating control delay, the delay a motorist experiences that is attributable to the presence of the traffic signal and conflicting traffic. This includes time spent decelerating, in queue, and accelerating.

The control delay equation comprises three elements: uniform delay, incremental delay, and initial queue delay. The primary factors that affect control delay are lane group volume, lane group capacity, cycle length, and effective green time. Factors are provided that account for various conditions and elements, including signal controller type, upstream metering, and delay and queue effects from oversaturated conditions.

Control delay is used as the basis for determining LOS. Intersection control delay is generally computed as a weighted average of the average control delay for all lane groups based on the amount of volume within each lane group. Caution should be exercised when evaluating an intersection based on a single value of control delay because this is likely to over- or underrepresent operations for individual lane groups. Delay thresholds for the various LOS are given in table 33.

Table 33. Motor vehicle LOS thresholds at signalized intersections.⁽²⁾

LOS	Control Delay per Vehicle (seconds per vehicle)
A	≤ 10
B	> 10-20
C	> 20-35
D	> 35-55
E	> 55-80
F	> 80

7.1.3 Motor Vehicle Queue

Vehicle queuing is an important measure of effectiveness that should be evaluated as part of all analyses of signalized intersections. Estimates of vehicle queues are needed to determine the

amount of storage required for turn lanes and to determine whether spillover occurs at upstream facilities (driveways, unsignalized intersections, signalized intersections, etc.). Approaches that experience extensive queues also are likely to experience an overrepresentation of rear-end collisions.

Vehicle queues for design purposes are typically estimated based on the 95th percentile queue that is expected during the design period. Appendix G to chapter 16 of the *HCM 2000* provides procedures for calculating back of queue. In addition, all known simulation models provide ways of obtaining queue estimates.

7.1.4 Transit Level of Service

The assessment of transit capacity and quality of service is the subject of its own reference document, the *Transit Capacity and Quality of Service Manual*.⁽⁷⁵⁾ In addition, on-street elements from that document are presented in the *HCM 2000* in chapters 14 and 27.⁽²⁾ Space does not permit the reproduction of these elements in this document; therefore the reader is encouraged to review these references for more information on the variety of quality-of-service measures and capacity estimation techniques available.

7.1.5 Bicycle Level of Service

The *HCM 2000* provides an analysis procedure for assessing the LOS for bicycles at signalized intersections where there is a designated on-street bicycle lane on at least one approach. This section replicates the procedure from chapter 19 of the *HCM 2000*.

Many countries have reported a wide range of capacities and saturation flow rates for bicycle lanes at signalized intersections. The *HCM 2000* recommends the use of a saturation flow rate of 2,000 bicycles per hour as an average value achievable at most intersections. This rate assumes that right-turning motor vehicles yield the right-of-way to through bicyclists. Where aggressive right-turning traffic exists, this rate may not be achievable, and local observations are recommended to determine an appropriate saturation flow rate.

Using the default saturation flow rate of 2,000 bicycles per hour, the capacity of the bicycle lane at a signalized intersection may be computed using equation 6:

$$c_b = s_b \frac{g}{C} = 2000 \frac{g}{C} \quad (6)$$

Where: c_b = capacity of bicycle lane (bicycles/hour)
 s_b = saturation flow rate of bicycle lane (bicycles/hour)
 g = effective green time for bicycle lane in seconds (s)
 C = signal cycle length (s)

At most signalized intersections, the only delay to bicycles is caused by the signal itself because bicycles have right-of-way over turning motor vehicles. Where bicycles are forced to weave with motor vehicle traffic or where bicycle right-of-way is disrupted due to turning traffic, additional delay may be incurred. Control delay is estimated using the first term of the delay equation for motor vehicles at signalized intersections, which assumes that there is no overflow delay. This is reasonable in most cases, as bicyclists will not normally tolerate an overflow situation and will use other routes. This control delay is estimated using equation 7:

$$d_b = \frac{0.5C \left(1 - \frac{g}{C}\right)^2}{1 - \left[\frac{g}{C} \min\left(\frac{v_b}{c_b}, 1.0\right) \right]} \quad (7)$$

Where: d_b = control delay (s/bicycle)
 g = effective green time for bicycle lane (s)
 C = signal cycle length (s)
 v_b = flow rate of bicycles in the bicycle lane (one direction) (bicycles/h)
 c_b = capacity of bicycle lane (bicycles/h)

Table 34 indicates LOS criteria for bicycles at signalized intersections on the basis of control delay.

Table 34. Bicycle LOS thresholds at signalized intersections.⁽²⁾

LOS	Control Delay per Bicycle (s/bicycle)
A	≤ 10
B	> 10-20
C	> 20-30
D	> 30-40
E	> 40-60
F	> 60

7.1.6 Pedestrian Level of Service

In the *HCM 2000* (chapter 18), pedestrian LOS is determined based on the average delay per pedestrian (i.e., wait time). Pedestrian delay is calculated using two parameters: cycle length and effective green time for pedestrians. In the absence of field data, the *HCM 2000* recommends estimating effective green time for pedestrians by taking the walk interval and adding 4 seconds of the flashing DON'T WALK interval to account for pedestrians who depart the curb after the start of flashing DON'T WALK. Equation 8 shows the equation for calculating pedestrian delay based on equation 18-5 of the *HCM 2000*:

$$d_p = \frac{.5(C - g)^2}{C} \quad (8)$$

Where: d_p = average pedestrian delay (s)
 C = cycle length (s)
 g = effective green time for pedestrians (s)

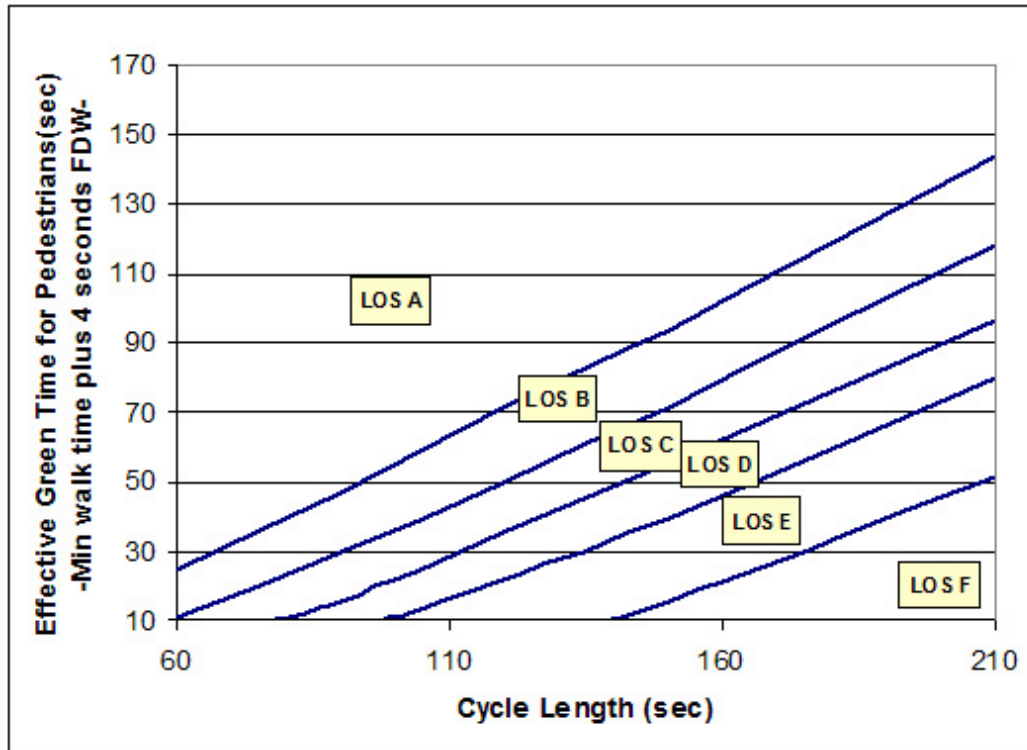
Table 35 indicates the LOS thresholds for pedestrian crossings at signalized intersections.

Table 35. Pedestrian LOS thresholds at signalized intersections.⁽²⁾

LOS	Pedestrian Delay (sec/ped)	Likelihood of Noncompliance
A	< 10	Low
B	≥ 10-20	
C	> 20-30	Moderate
D	> 30-40	
E	> 40-60	High
F	> 60	Very High

Figure 55 illustrates the amount of effective green time required for pedestrians to achieve each LOS threshold based on a specified cycle length. As shown in the figure, the amount of green time required for pedestrian crossings to meet a LOS D standard increases with longer

cycle lengths. For cycle lengths in excess of 150 seconds, a minimum pedestrian effective green time of 40 seconds is required to maintain LOS D.



Note: FDW = Flashing "DON'T WALK"

Figure 55. Pedestrian LOS based on cycle length and minimum effective pedestrian green time.⁽²⁾

7.2 TRAFFIC OPERATIONS ELEMENTS

Signalized intersection operations are a function of three elements described in the following sections along with a discussion on their effect on operations.

- Traffic volume characteristics.
- Roadway geometry.
- Signal timing.

7.2.1 Traffic Volume Characteristics

The traffic characteristics used in an analysis can play a critical role in determining intersection treatments. Overconservative judgment may result in economic inefficiencies due to the construction of unnecessary treatments, while the failure to account for certain conditions (such as a peak recreational season) may result in facilities that are inadequate and experience failing conditions during certain periods of the year.

An important element of developing an appropriate traffic profile is distinguishing between traffic demand and traffic volume. For an intersection, traffic demand represents the arrival pattern of vehicles, while traffic volume is generally measured based on vehicles' departure rate. For the case of overcapacity or constrained situations, the traffic volume may not reflect the true

demand on an intersection. In these cases, the user should develop a demand profile. This can be achieved by measuring vehicle arrivals upstream of the overcapacity or constrained approach. The difference between arrivals and departures represents the vehicle demand that does not get served by the traffic signal. This volume should be accounted for in the traffic operations analysis.

Traffic volume at an intersection may also be less than the traffic demand due to an overcapacity condition at an upstream or downstream signal. When this occurs, the upstream or downstream facilities “starve” demand at the subject intersection. This effect is often best accounted for using a microsimulation analysis tool.

7.2.2 Intersection Geometry

The geometric features of an intersection influence the service volume or amount of traffic an intersection can process. A key measure used to establish the supply of an intersection is saturation flow, which is similar to capacity in that it represents the number of vehicles that traverse a point per hour; however, saturation flow is reported assuming the traffic signal is green the entire hour. By knowing the saturation flow and signal timing for an intersection, one can calculate the capacity (capacity = saturation flow times the ratio of green time to cycle length). Saturation headway is determined by measuring the average time headway between vehicles that discharge from a standing queue at the start of green, beginning with the fourth vehicle.⁽²⁾ Saturation headway is expressed in time (seconds) per vehicle.

Saturation flow rate is simply determined by dividing the average saturation headway into the number of seconds in an hour, 3,600, to yield units of vehicles per hour. The *HCM 2000* uses a default ideal saturation flow rate of 1,900 vehicles per hour. Ideal saturation flow assumes 3.6-m (12-ft)-wide travel lanes, through movements only, and no curbside impedances, pedestrians/bicyclists, grades, or central business district influences. The *HCM 2000* provides adjustment factors for nonideal conditions to estimate the prevailing saturation flow rate. Saturation flow rate can vary in time and location. Saturation flow rates have been observed to range between 1,500 and 2,000 passenger cars per hour per lane.⁽²⁾ Given the variation that exists in saturation flow rates, local data should be collected where possible to increase the accuracy of the analysis.

Existing or planned intersection geometry should be evaluated to determine features that may impact operations and that require special consideration.

7.2.3 Signal Timing

The signal timing of an intersection also plays an important role in its operational performance. Key factors include:

- **Effective green time.** Effective green time represents the amount of usable time available to serve vehicular movements during a phase of a cycle. It is equal to the displayed green time minus startup loss time plus end gain. The effective green time for each phase is generally determined based on the proportion of volume in the critical lane for that phase relative to the total critical volume of the intersection. If not enough green time is provided, vehicle queues will not be able to clear the intersection, and cycle failures will occur. If too much green time is provided, portions of the cycle will be unused resulting in inefficient operations and frustration for drivers on the adjacent approaches.
- **Clearance interval.** The clearance interval represents the amount of time needed for vehicles to safely clear the intersection and includes the yellow change and red clearance intervals. The capacity effect of the clearance interval is dependent upon the loss time.
- **Loss time.** Loss time represents the unused portion of a vehicle phase. Loss time occurs twice during a phase: at the beginning when vehicles are accelerating from a

stopped position, and at the end when vehicles decelerate in anticipation of the red indication. Longer loss times reduce the amount of effective green time available and thus reduce the capacity of the intersection. Wide intersections and intersections with skewed approaches or unusual geometrics typically experience greater loss times than conventional intersections.

- **Cycle length.** Cycle length determines how frequently during the hour each movement is served. It is either a direct input, in the case of pre-timed or coordinated signal systems running a common cycle length, or an output of vehicle actuations, minimum and maximum green settings, and clearance intervals. Cycle lengths that are too short do not provide adequate green time for all phases and result in cycle failures. Longer cycle lengths result in increased delay and queues for all users.
- **Progression.** Progression is the movement of vehicle platoons from one signalized intersection to the next. A well-progressed or well-coordinated system moves platoons of vehicles so that they arrive during the green phase of the downstream intersection. When this occurs, fewer vehicles arrive on red, and vehicle delay and queues are minimized. A poorly coordinated system moves platoons such that vehicles arrive on red, which increases the delay and queues for those movements beyond what would be experienced if random arrivals occurred.

7.3 RULES OF THUMB FOR SIZING AN INTERSECTION

This is the first level of analysis. It is the only level that does not use formal models or procedures. Instead, it relies on the collective experience of past practice. As such, it offers only a very coarse approximation of a final answer.

In spite of its obvious limitations, this approach can be used to size an intersection and determine appropriate lane configurations. The literature provides guidelines, shown in table 36, for determining intersection geometry at the planning level.

Table 36. Planning-level guidelines for sizing an intersection.

Geometric Property	Comment
Number of lanes ⁽²⁾	As a general suggestion, enough roadway lanes should be provided to prevent a lane from exceeding 450 vehicles per hour. Mainline facilities that are allocated the majority of green time may accommodate higher volumes. Other elements that should be considered in the sizing of a facility include the number of upstream/downstream lanes, lane balance, signal design elements, pedestrian/bicycle effects, right-of-way constraints, and safety implications.
Exclusive left-turn lanes ⁽²⁾	The decision to provide an exclusive left-turn lane should generally be based on the volume of left-turning and opposing traffic, intersection design, and safety implications. Exclusive left-turn lanes should be investigated when a left-turn volume exceeds 100 vehicles per hour. Dual left-turn lanes could be considered when the left-turn volume exceeds 300 vehicles per hour. On some facilities, left-turn lanes may be desirable at all locations regardless of volume.
Exclusive right-turn lanes ⁽²⁾	The provision of right-turn lanes reduces impedances between lower speed right-turning vehicles and higher speed left-turning vehicles. Separating right turns also reduces the green time required for a through lane. Safety implications associated with pedestrians and bicyclists should be considered. In general, a right-turn lane at a signalized intersection should be considered when the right-turn volume and adjacent through lane volume each exceeds 300 vehicles per hour.
Left-turn storage bay length ⁽⁴¹⁾	Storage bays should accommodate twice the average number of left-turn arrivals during a cycle.

7.4 CRITICAL MOVEMENT ANALYSIS

Critical movement analysis (CMA) is usually applied at the planning stage; represents the highest of the 4 levels of operational performance models. Various versions of CMA procedures have been widely used over the past 20 years, including:

- Transportation Research Board (TRB) Circular 212,⁽⁷⁶⁾ which presented interim capacity materials that preceded the release of the 1985 HCM.⁽⁷³⁾
- The Intersection Capacity Utilization (ICU) method, which is popular in parts of California.
- The HCM Planning Method, as set forth in the 1985, 1994, and 1997 versions of the HCM.^(73,77,78)
- The Quick-Estimation Method (QEM), which now appears in the *HCM 2000* as a refinement of the planning method found in previous HCM editions.⁽²⁾

Most agencies would consider the QEM to be the most current, and therefore the preferred, procedure for conducting critical movement analyses; thus it will be described in detail here.

The QEM procedures can be carried out by hand, although software implementation is much more productive. The computations themselves are somewhat complex, but the minimal requirement for site-specific field data (traffic volumes and number of lanes) is what puts the QEM into the category of a simple procedure. While the level of output detail is simplified in comparison to more data-intensive analysis procedures, the QEM provides a useful description of the operational performance by answering the following questions:

- What are the critical movements at the intersection?
- Is the intersection operating below, near, at, or above capacity?
- Where are capacity improvements needed?

The requirement for site-specific data is minimized through the use of assumed values for most of the operating parameters and by a set of steps that synthesizes a “reasonable and effective” operating plan for the signal. Figure 56 illustrates the various steps involved in conducting a QEM analysis, and table 37 identifies the various thresholds for v/c ratio.

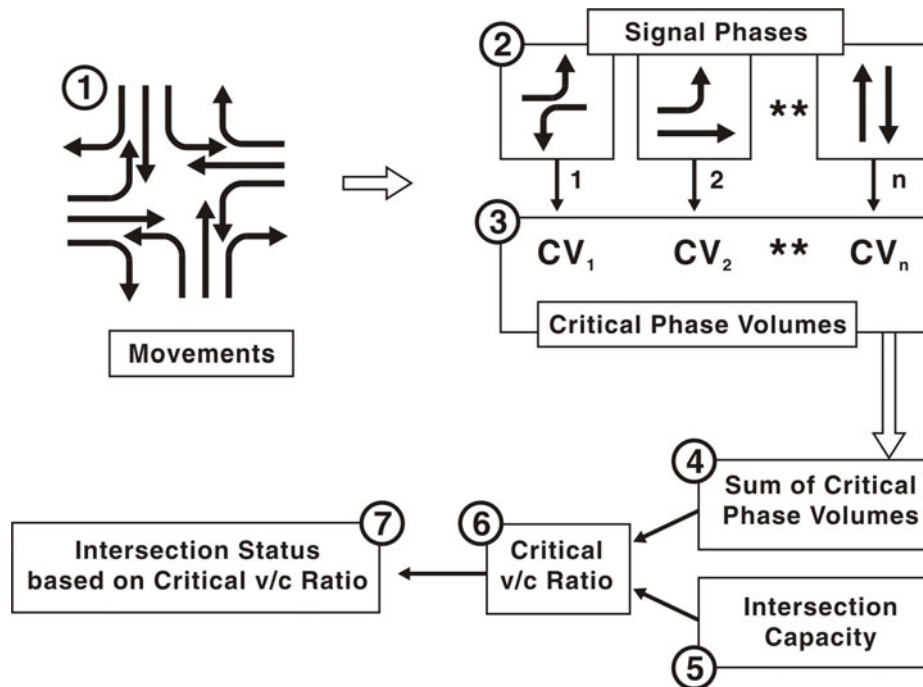


Figure 56. Graphical summary of the Quick Estimation Method.

Step 1—Identify movements to be served and assign hourly traffic volumes per lane. This is the only site-specific data that must be provided. The hourly traffic volumes are usually adjusted to represent the peak 15-minute period. The number of lanes must be known to compute the hourly volumes per lane.

Step 2—Arrange the movements into the desired signal phasing plan. The phasing plan is based on the treatment of each left turn (protected, permitted, etc.). The actual left-turn treatment may be used, if known. Otherwise, the likelihood of needing left-turn protection on each approach will be established from the left-turn volume and the opposing through traffic volume.

Step 3—Determine the critical volume per lane that must be accommodated on each phase. Each phase typically accommodates two nonconflicting movements. This step determines which movements are critical. The critical movement volume determines the amount of time that must be assigned to the phase on each signal cycle.

Step 4—Sum the critical phase volumes to determine the overall critical volume that must be accommodated by the intersection. This is a simple mathematical step that produces an estimate of how much traffic the intersection needs to accommodate.

Step 5—Determine the maximum critical volume that the intersection can accommodate: This represents the overall intersection capacity. The HCM QEM suggests 1,710 vph for most purposes.

Step 6—Determine the critical volume-to-capacity ratio, which is computed by dividing the overall critical volume by the overall intersection capacity, after adjusting the intersection capacity to account for time lost due to starting and stopping traffic on each cycle. The lost time will be a function of the cycle length and the number of protected left turns.

Step 7—Determine the intersection status from the critical volume-to-capacity ratio. The status thresholds are given in table 37.

Table 37. V/C ratio threshold descriptions for the Quick Estimation Method.⁽²⁾

Critical Volume-to-Capacity Ratio	Assessment
< 0.85	Intersection is operating under capacity. Excessive delays are not experienced.
0.85-0.95	Intersection is operating near its capacity. Higher delays may be expected, but continuously increasing queues should not occur.
0.95-1.0	Unstable flow results in a wide range of delay. Intersection improvements will be required soon to avoid excessive delays.
> 1.0	The demand exceeds the available capacity of the intersection. Excessive delays and queuing are anticipated.

Understanding the critical movements and critical volumes of a signalized intersection is a fundamental element of any capacity analysis. A CMA should be performed for all intersections considered for capacity improvement. The usefulness and effectiveness of this step should not be overlooked, even for cases where more detailed levels of analysis are required. The CMA procedure gives a quick assessment of the overall sufficiency of an intersection. For this reason, it is useful as a screening tool for quickly evaluating the feasibility of a capacity improvement and discarding those that are clearly not viable.

Some limitations of CMA procedures in general, and the QEM in particular:

- No provision exists for the situation of when the timing requirements for a concurrent pedestrian phase (such as for crossing a wide street) exceed the timing requirements for the parallel vehicular phase. As a result, the CMA procedure may underestimate the green time requirements for a particular phase.
- A fixed value is assumed for the overall intersection capacity per lane. Adjustment factors are not provided to account for differing conditions among various sites and there is no provision for the use of field data to override the fixed assumption.
- Complex phasing schemes such as lagging left-turn phases, right-turn overlap with a left-turn movement, exclusive pedestrian phases, leading/lagging pedestrian intervals, etc., are not considered. Significant operational and/or safety benefits can sometimes be achieved by the use of complex phasing.
- Loss time is not directly accounted for in the CMA procedures. Therefore, the effect of longer change and clearance intervals cannot be directly accommodated with this procedure.
- The synthesized operating plan for the signal does not take minimum green times into account, and therefore may not be readily implemented as a part of an intersection design. The HCM specifically warns against the use of the QEM for signal timing design.
- Performance measures (e.g., control delay, LOS, and back of queue) are not provided.

For these reasons, it frequently will be necessary to examine the intersection using a more detailed level of operational performance modeling.

7.5 HCM OPERATIONAL PROCEDURE FOR SIGNALIZED INTERSECTIONS

For many applications, performance measures such as vehicle delay, LOS, and queues are desired. These measures are not reported by the CMA procedures, but are provided by macroscopic-level procedures such as the HCM operational analysis methodology for signalized intersections. This procedure is represented as the second analysis level in figure 54. Macroscopic-level analyses provide results over multiple cycle lengths based on hourly vehicle demand and service rates. HCM analyses are commonly performed for 15-minute periods to accommodate the heaviest part of the peak hour.

The HCM analysis procedures provide estimates of saturation flow, capacity, delay, LOS, and back of queue by lane group for each approach. Exclusive turn lanes are considered as separate lane groups. Lanes with movements that are shared are considered a single lane group. Lane group results can be aggregated to estimate average control delay per vehicle at the intersection level.

The increased output detail compared to the CMA procedure is obtained at the expense of additional input data requirements. A complete description of intersection geometrics and operating parameters must be provided. Several factors that influence the saturation flow rates (e.g., lane width, grade, parking, pedestrians) must be specified. A complete signal operating plan, including phasing, cycle length, and green times, must be developed externally. As indicated in figure 54, an initial signal operating plan may be obtained from the QEM, or a more detailed and implementable plan may be established using a signal timing model that represents the next level of analysis. Existing signal timing may also be obtained from the field.

In addition to the signalized intersection procedure, the HCM also includes procedures to estimate the LOS for bicyclists, pedestrians, and transit users at signalized intersections. These have been discussed previously in this chapter.

Known limitations of the HCM analysis procedures for signalized intersections exist under the following conditions:

- Available software products that perform HCM analyses generally do not accommodate intersections with more than four approaches.
- The analysis may not be appropriate for alternative intersection designs.
- The effect of queues that exceed the available storage bay length is not treated in sufficient detail, nor is the backup of queues that block a stop line during a portion of the green time.
- Driveways located within the influence area of signalized intersections are not recognized.
- The effect of arterial progression in coordinated systems is recognized, but only in terms of a coarse approximation.
- Heterogeneous effects on individual lanes within multilane lane groups (e.g., downstream taper, freeway on-ramp, driveways) are not recognized.

If any of these conditions exist, it may be necessary to proceed to the next level of analysis.

7.6 ARTERIAL AND NETWORK SIGNAL TIMING MODELS

As with the HCM procedures, arterial and network signal timing models are also macroscopic in nature. They do, however, deal with a higher level of detail, and are more oriented to operational design than is the HCM. The effect of traffic progression between intersections is treated explicitly, either as a simple time-space diagram or a more complex platoon propagation phenomenon. In addition, these models can explicitly account for pedestrian actuations at intersections and their effect on green time for affected phases.

These models attempt to optimize some aspect of the system performance as a part of the design process. The two most common optimization criteria are quality of progression as perceived by the driver, and overall system performance, using measures such as stops, delay, and fuel consumption. As indicated in figure 54, the optimized signal timing plan may be passed back to the HCM analysis or forward to the next level of analysis, which involves microscopic simulation.

While the signal timing models are more detailed than the HCM procedures in most respects, they are less detailed when it comes to determining the saturation flow rates. The HCM provides the computational structure for determining saturation flow rates as a function of geometric and operational parameters. On the other hand, saturation flow rates are generally treated as input data by signal timing models. The transfer of saturation flow rate data between the HCM and the signal timing models is therefore indicated on figure 54 as a part of the data flow between the various analysis levels.

The additional detail present in the signal timing models overcomes many of the limitations of the HCM for purposes of operational analysis of signalized intersections. It will not generally be necessary to proceed to the final analysis level, which involves microscopic simulation, unless complex interactions take place between movements or additional outputs, such as animated graphics, are considered desirable.

7.7 MICROSCOPIC SIMULATION MODELS

For cases where individual cycle operations and/or individual vehicle operations are desired, a microscopic-level analysis should be considered to supplement the aggregate results provided by the less detailed analysis levels. Microscopic analyses are performed using one or more of several simulation software products. Microsimulation analysis tools are based on a set of rules used to propagate the position of vehicles from one second to the next. Rules such as car following, yielding, response to signals, etc., are an intrinsic part of each simulation software package. The rules are generally stochastic in nature, in other words there is a random variability associated with each aspect of the operation. Some simulation tools produce animated graphical outputs to illustrate the operating conditions on a vehicle-by-vehicle and second-by-second basis for a given time period. Some simulation models can explicitly model pedestrians, enabling the analyst to study the impedance effects of vehicles on pedestrians and vice versa. However, the pedestrian modeling ability of most simulation programs is quite simplistic and does not capture the full range of pedestrian activity and ability.

Microscopic models produce nominally the same measures of effectiveness as their macroscopic counterparts, although minor differences exist in the definition of some measures. Pollutant discharge measures are typically included in microscopic results. Interestingly, one of the most important measures, capacity, is notably absent from simulation results because the nature of simulation models does not lend itself to capacity computations

Microscopic simulation tools can be particularly effective for cases where intersections are located within the influence area of adjacent signalized intersections and are affected by upstream and/or downstream operations. In addition, graphical simulation output may be desired to verify field observations and/or provide a visual description of traffic operations for an audience. Microscopic simulation tools also can be used to identify the length of time that a condition occurs, and can account for the capacity and delay effects associated with known system-wide travel patterns.

The level of effort involved with developing a microscopic simulation network is considerably greater than that of a macroscopic analysis, and enormously greater than a critical movement analysis. Like the HCM operational procedure, microscopic simulation tools require a fully specified signal-timing plan that must be generated externally. Unlike the HCM, however, an extensive calibration effort using field data is essential to the production of credible results. For this reason, the decision of whether to use a microscopic simulation tool should be made on a case-by-case basis, considering the resources available for acquisition of the software and for collecting the necessary data for calibrating the model to the intersection being studied.

Part III

Treatments

Part III includes a description of treatments that can be applied to signalized intersections to mitigate an operational and/or safety deficiency. The treatments are organized as follows: System-Wide Treatments (chapter 8), Intersection-Wide Treatments (chapter 9), Alternative Intersection Treatments (chapter 10), Approach Treatments (chapter 11), and Individual Movement Treatments (chapter 12). It is assumed that before readers begin to examine treatments in part III, they will already have familiarized themselves with the fundamental elements described in part I and the project process and analysis methods described in part II.

CHAPTER 8

SYSTEM-WIDE TREATMENTS

TABLE OF CONTENTS

8.0	SYSTEM-WIDE TREATMENTS	163
8.1	Median Treatments	163
8.1.1	Description	163
8.1.2	Applicability	163
8.1.3	Key Design Features	163
8.1.4	Safety Performance	169
8.1.5	Operational Performance.....	169
8.1.6	Multimodal Impacts	169
8.1.7	Physical Impacts	170
8.1.8	Socioeconomic Impacts	170
8.1.9	Enforcement, Education, and Maintenance.....	170
8.1.10	Summary.....	170
8.2	Access Management.....	171
8.2.1	Description	171
8.2.2	Applicability	172
8.2.3	Design Features.....	172
8.2.4	Safety Performance	177
8.2.5	Operational Performance.....	177
8.2.6	Multimodal Impacts	178
8.2.7	Physical Impacts	178
8.2.8	Socioeconomic Impacts	178
8.2.9	Enforcement, Education, and Maintenance.....	178
8.2.10	Summary.....	178
8.3	Signal Coordination.....	179
8.3.1	Description	179
8.3.2	Applicability	179
8.3.3	Safety Performance	180
8.3.4	Operational Performance.....	180
8.3.5	Multimodal Impacts	181
8.3.6	Physical Impacts	181
8.3.7	Socioeconomic Impacts	181
8.3.8	Enforcement, Education, and Maintenance.....	181
8.3.9	Summary.....	181
8.4	Signal Preemption and/or Priority	181
8.4.1	Description	181
8.4.2	Emergency Vehicle Preemption.....	182
8.4.3	Applicability	182
8.4.4	Safety Performance	183
8.4.5	Operational Performance.....	183
8.4.6	Multimodal Impacts	183
8.4.7	Physical Impacts	183
8.4.8	Socioeconomic Impacts	183
8.4.9	Enforcement, Education, and Maintenance.....	183
8.4.10	Summary.....	183

LIST OF FIGURES

<u>Figure</u>		<u>Page</u>
57	Issues associated with intersections with a narrow median	164
58	Issues associated with intersections with a wide median.....	165
59	Median pedestrian treatments	167
60	Median pedestrian signal treatments.....	168
61	This refuge island enables two-stage pedestrian crossings.....	169
62	Comparison of physical and functional areas of an intersection	172
63	Diagram of the upstream functional area of an intersection.....	173
64	Access points near signalized intersections	175
65	Access management requiring U-turns at a downstream signalized intersection.....	176
66	Access management requiring U-turns at an unsignalized, directional median opening...	176

LIST OF TABLES

<u>Table</u>		<u>Page</u>
38	Summary of issues for providing median treatments	171
39	Relative crash rates for unsignalized intersection access spacing	177
40	Summary of issues for providing access management.....	179
41	Selected findings of safety benefits associated with signal coordination or progression...	180
42	Summary of issues for providing signal coordination	181
43	Summary of issues for providing signal preemption and/or priority.....	184

8. SYSTEM-WIDE TREATMENTS

Treatments in this chapter apply to roadway segments located within the influence of signalized intersections and intersections affected by the flow of traffic along a corridor. They primarily address safety deficiencies associated with rear-end collisions due to sudden accelerating/decelerating; turbulence involved with midblock turning movements from driveways or unsignalized intersections; and coordination deficiencies associated with the progression of traffic from one location to another. Four specific treatments are examined:

- Median treatments.
- Access management.
- Signal coordination.
- Signal preemption and/or priority.

8.1 MEDIAN TREATMENTS

The median of a divided roadway is used for left turns, pedestrian refuge, access to properties on the other side of the road, and separation of opposing directions of travel. These purposes can conflict, and each use should be considered when design changes are proposed.

8.1.1 Description

Median design contributes to safe and efficient operation of intersections, especially left-turn movements. Specifically, width and type are key factors in median design. The median provides a location for vehicles to wait for a gap in opposing traffic through which to turn; it also separates opposing directions of travel. Inappropriate median design may contribute to operational or safety problems related to vehicles turning left from the major road and vehicles proceeding through or turning left from the minor road.

8.1.2 Applicability

Operational or safety issues that provide evidence that median design changes may be appropriate include spillover of left-turn lanes into the through traffic stream, rear-end or side-swipe crashes involving left-turning vehicles, inappropriate use of the median, and pedestrian crashes. Medians may also form an integral part of an overall access management plan, as discussed later.

8.1.3 Key Design Features

Width, channelization, end type, and pedestrian treatments are key features of a median design. The elements combine to provide storage for left-turning vehicles, guide turning vehicles through the intersection, and help pedestrians cross the street.

Median Width

Medians physically separate opposing directions of travel, and provide a safety benefit by helping reduce occurrence of head-on collisions. It is possible that a median can be so narrow or so wide that its safety benefit is canceled by operational or safety problems created by an inappropriate width, as shown in figures 57 and 58.

- *Narrow medians:* Many of the problems associated with medians that are too narrow relate to unsignalized intersections upstream or downstream of the signalized intersection in question. These include vehicles stopping in the median at an angle instead of perpendicular to the major road, or long vehicles stopping in the median and encroaching on major road through lanes. However, pedestrians can have difficulty at signalized intersections with medians that are too narrow. At large intersections with medians, it is common to allow pedestrians to cross the street in two

stages. If the median width is too narrow, there may be insufficient room for pedestrians to wait safely and comfortably. In addition, there may be insufficient room to provide adequate ADA-compliant detectable warning surfaces and, in some cases, curb ramps.

- *Wide medians:* Just as medians that are too narrow can pose difficulties, overly wide medians also can be problematic. At signalized intersections, large medians increase motor vehicle and bicycle clearance time, thus adding loss time and delay to the intersection. If pedestrians are expected to cross both directions of traffic in one crossing, overly wide medians result in very long pedestrian clearance times, which often lead to excessively long cycle lengths. Wide medians also can create visibility problems for signal displays, which often results in the use of two sets of signal indications: one mid-intersection, and one on the far side. This increases the cost of construction and operation of the intersection.

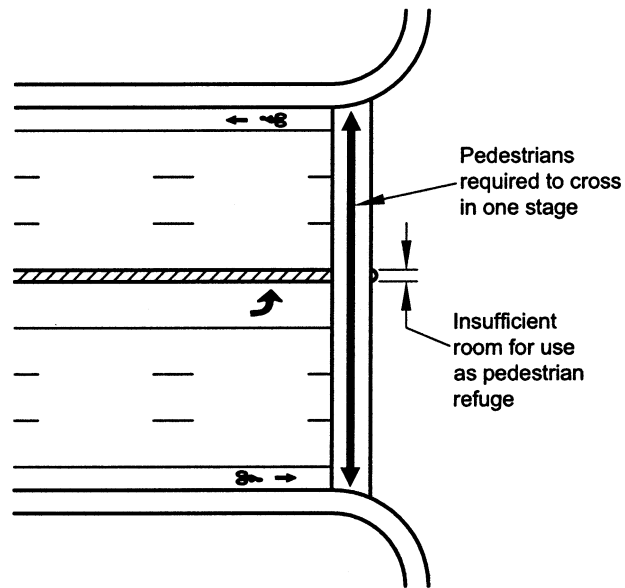


Figure 57. Issues associated with intersections with a narrow median.

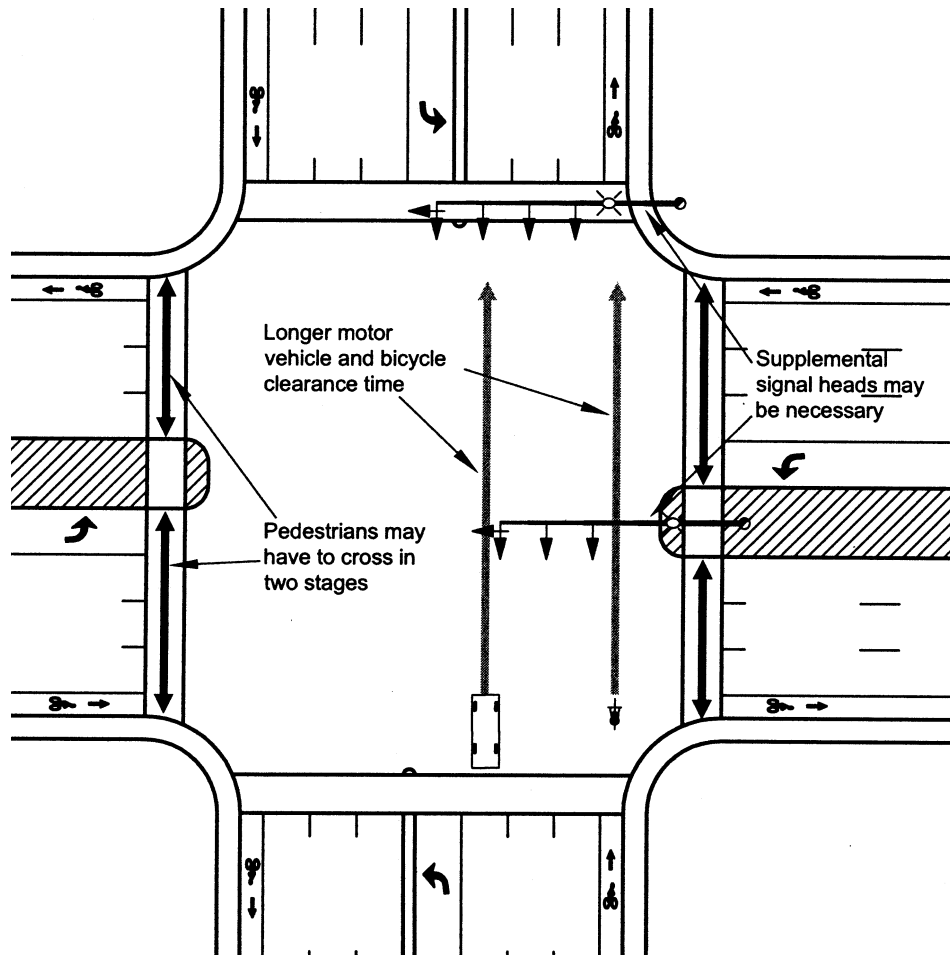


Figure 58. Issues associated with intersections with a wide median.

Median Channelization

The appropriateness of the use of raised or flush medians depends on conditions at a given intersection. Raised (curbed) medians should provide guidance in the intersection area but should not present a significant obstruction to vehicles. The design should be balanced between the desire for it to be cost effective to construct and maintain and for it to provide safe channelization. Raised medians should be delineated (such as with reflectors) if lighting is not provided at the intersection, since they are sometimes difficult to see at night. AASHTO recommends that flush medians are appropriate for intersections with:⁽³⁾

- Relatively high approach speeds.
- No lighting.
- Little development where access management will not be considered.
- No sign, signal, or luminaire supports in the median.
- Little/infrequent snowplowing operations.
- A need for left-turn storage space.
- Little or no pedestrian traffic.

Where left-turn lanes are provided in the median, curbed dividers should be used to separate left-turn and opposing through traffic on medians 4.8 m (16 ft) wide or less. These dividers should be 1.2 m (4 ft) wide. Medians 5.4 m (18 ft) wide or more should have a painted or physical divider that delineates the movements. It is also recommended that the left-turn lane be offset to provide improved visibility with opposing through traffic. This treatment is discussed in more detail in chapter 12.

Median End Type

AASHTO provides the following guidance for median ends:^(3, p. 701)

- Semicircular medians and bullet nose median ends perform the same for medians approximately 1.2 m (4 ft) wide.
- Bullet-nose median ends are preferred for medians 3.0 m (10 ft) or more wide.

A semicircle is an appropriate shape for the end of a narrow median. An alternative design is a bullet nose, which is based on the turning radius of the design vehicle. This design better guides a left-turning driver through the intersection, because the shape of the bullet nose reflects the path of the inner rear wheel. The bullet nose, being elongated, better serves as a pedestrian refuge than does a semicircular median end.

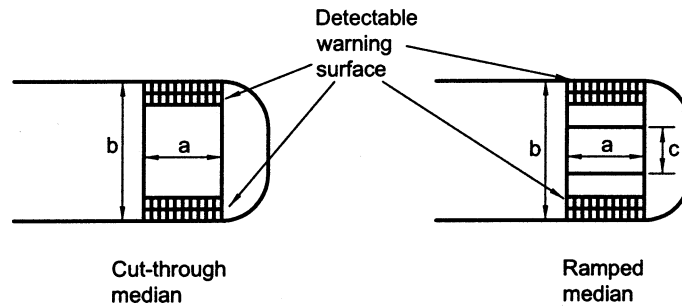
Medians greater than 4.2 m (14 ft) wide with a control radius of 12 m (40 ft) (based on the design vehicle) should have the shape of flattened or squared bullets to provide channelization, though the length of the median opening will be controlled by the need to provide for cross traffic.

The median end controls the turning radius for left-turning vehicles. It can affect movement of vehicles using that leg of the intersection both to turn left from the approach and to depart from the intersection on that leg after turning left from the cross street. A median nose that does not significantly limit the turning radius will help turning vehicles proceed through the intersection at higher speeds. This could contribute to efficient vehicular operations but could also create additional safety issues for pedestrians.

Median Pedestrian Treatments

Careful attention should be given to pedestrian treatments at signalized intersections with medians, as these intersections tend to be larger than most. Two key treatments are discussed here: the design of the pedestrian passage through the median, and the design of the pedestrian signalization.

Pedestrian treatments at medians can be accommodated in two basic ways: a cut-through median, where the pedestrian path is at the same grade as the adjacent roadway; and a ramped median, where the pedestrian path is raised to the grade of the top of curb. Figure 59 shows the basic features and dimensions for each treatment. Note that if the median is too narrow to accommodate a raised landing of minimum width, a ramped median design cannot be used. If the median is so narrow that a pedestrian refuge cannot be accommodated, then the crosswalk should be located outside the median. Per ADAAG, all curb ramps, including those at median crossings, must have detectable warnings. Further discussion of pedestrian treatments at medians can be found in FHWA's *Designing Sidewalks and Trails for Access: Part II*.⁽³⁴⁾



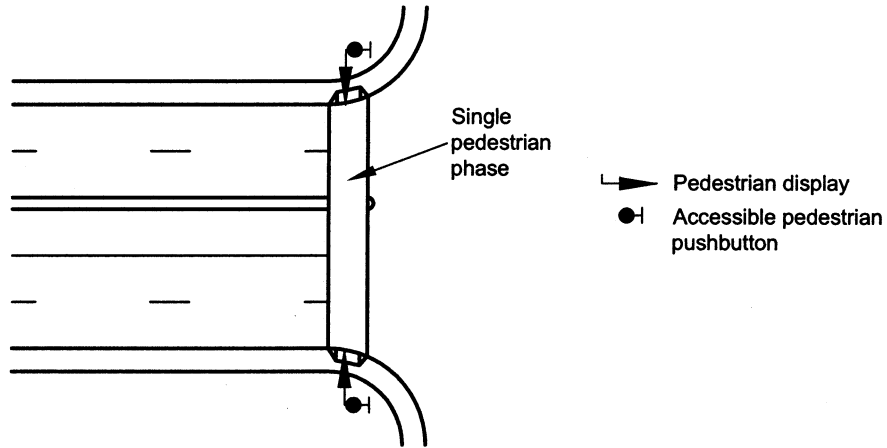
Key Dimensions:

- a: 915 mm (36 in) minimum, 1525 mm (60 in) preferred
- b: 1.22 m (48 in) minimum, 1.83 m (72 in) preferred for one-stage crossing; 1.83 m (72 in) minimum for two-stage crossing
- c: 1.22 m (48 in) minimum, 1.525 m (60 in) preferred

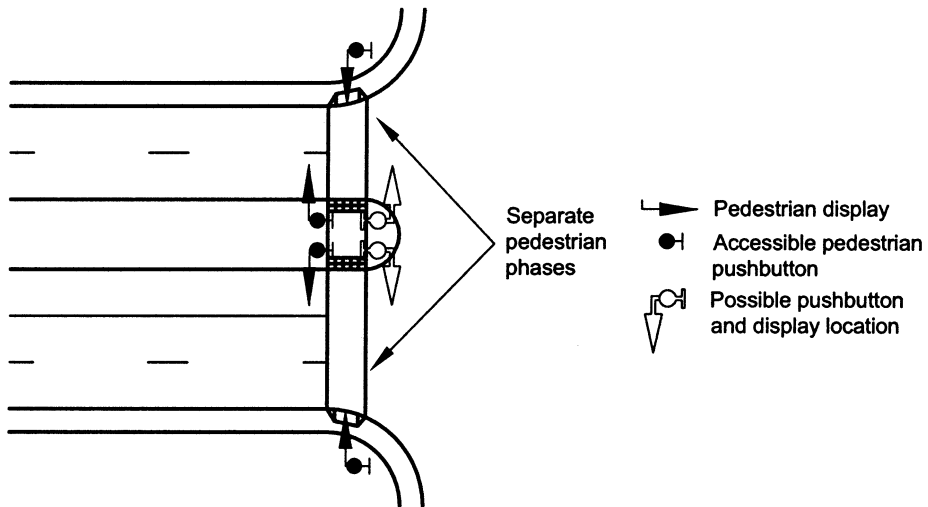
Figure 59. Median pedestrian treatments.⁽³⁴⁾

Pedestrian signal treatments also depend on the width of the median and are summarized in figure 60.

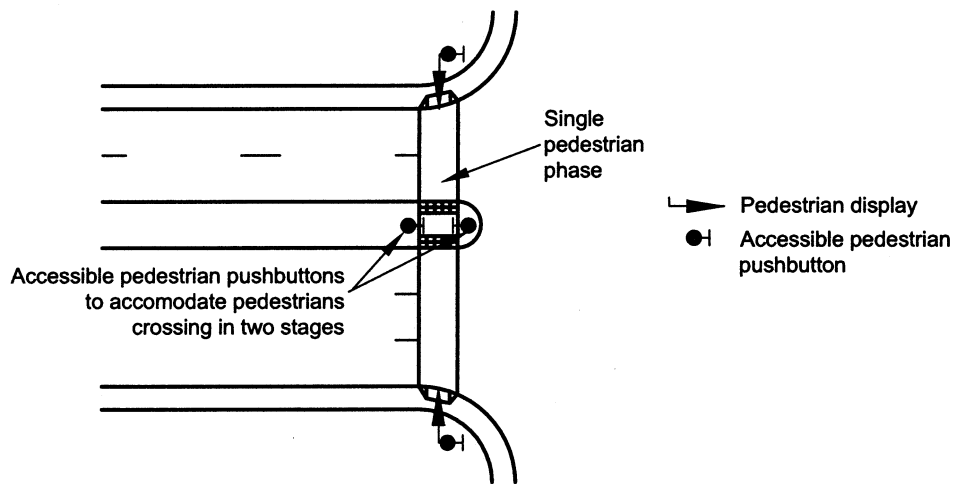
- For narrow crossings where no refuge is provided, a one-stage crossing is required using a single set of pedestrian signal displays and detectors. For this option, pedestrian clearance time needs to accommodate crossing the entire roadway.
- For wide medians where there is ample room for pedestrians to wait in the median and where it is advantageous to all users to cross in two stages, separate pedestrian signal displays and detectors can be provided for each half of the roadway. Pedestrian clearance times are set independently for each half of the roadway. An example of this is also shown in figure 61.
- A third option is for crossings where part of the pedestrian population can be reasonably expected to cross in one stage, but others need two stages. For this option, pedestrian clearance time is set to accommodate crossing the entire roadway, but a supplemental pedestrian detector is placed in the median to accommodate pedestrians needing to cross in two stages.



(a) One-stage pedestrian crossing.



(b) Two-stage pedestrian crossing.



(c) One-stage pedestrian crossing with optional two-stage crossing.

Figure 60. Median pedestrian signal treatments.



Photograph Credit: Synectics Transportation Consultants, Inc.

Figure 61. This refuge island enables two-stage pedestrian crossings.

8.1.4 Safety Performance

Provision of medians at intersections provides safety benefits similar to medians between intersections. One report has shown that at urban and suburban intersections, multiple-vehicle crash frequency increases as median width increases for widths between 4.2 m (14 ft) and 24 m (80 ft), unlike in rural areas where multiple-vehicle crash rates tend to be lower for wider medians.⁽⁷⁹⁾ The report also provided a summary of a study that found no statistically significant effect of median width on traffic delays and conflicts on medians between 9 m (30 ft) and 18 m (60 ft) wide.⁽⁸⁰⁾

One study found decreasing crash rates with increasing median widths.⁽⁸¹⁾ A Michigan State University study found that Michigan's boulevard roadways experience a crash rate half that of roadways with continuous center left-turn lanes.⁽⁸²⁾ A median width of 9.15 m (30 ft) to 18.30 m (60 ft) was found to be the most effective in providing a safe method for turning left.

8.1.5 Operational Performance

Simulation of signalized directional crossovers showed they operate better than other designs (specifically, an undivided cross section with a continuous center left-turn lane and a boulevard with bidirectional crossovers). The undivided cross section has larger delays for left-turning vehicles than do boulevard roadways, even for low turn volumes. The width of the median affects the storage capacity of the crossover, of course, so a crossover in a narrow median may not function as well as a left-turn lane. The signalized crossovers functioned more efficiently (i.e., with less time to make a left-turn) than did stop-controlled crossovers.⁽⁸³⁾

8.1.6 Multimodal Impacts

As noted previously, the width of the median (and the roadway in general) has a direct relationship with the amount of time needed for pedestrians and bicycles to cross the roadway. Large intersections that have no median or a median too narrow to provide a refuge force pedestrians to cross the entire street in one stage. Therefore, the provision of a median with at least enough width to accommodate a pedestrian can provide pedestrians with the option of crossing in one stage or two. This can be a significant benefit to elderly and disabled pedestrians who cross at speeds less than the typical 1.2 m/s (4 ft/s) or 1.1 m/s (3.5 ft/s) used to time pedestrian clearance intervals.

If the median is so wide that pedestrian crossings are operated in two stages, the sequence of the stages may increase crossing time significantly. For example, if the vehicle phases running parallel to the pedestrian crossing in question are split-phased and the sequence of the vehicle phases is in the same direction as the pedestrian, crossing time is similar to that of a single-stage crossing. On the other hand, the reverse direction will result in additional delay to the pedestrian in the median area as the signal cycles through all conflicting phases.

8.1.7 Physical Impacts

Improvements made in the median should not have an effect on the footprint of an intersection unless a roadway is widened to provide the median to use for left-turn lanes, pedestrian refuges, and so on. Use of a curbed median or separator between left and opposing through traffic would add a vertical component to the intersection that should accommodate the necessary curb cuts.

8.1.8 Socioeconomic Impacts

The primary socioeconomic impact of medians at signalized intersections relates more to their effect on overall access within the corridor, which is discussed in section 8.2. However, landscaping can play an important aesthetic role at the intersection itself. The appropriate use of landscaping can visually enhance a road and its surroundings. Landscaping may act as a buffer between pedestrians and motorists, and reduce the visual width of a roadway, serving to reduce traffic speeds and providing a more pleasant environment.

Landscaping must be carefully considered at signalized intersections, otherwise it will prevent motorists from making left and right turns safely because of inadequate sight distances. Care should be taken to ensure that traffic signs, pedestrian crossings, nearby railroad crossings, and school zones are not obstructed. Median planting of trees or shrubs greater than 0.6 m (2 ft) in height should be well away from the intersection (more than 15 m (50 ft)). No plantings having foliage between 0.6 m (2 ft) and 2.4 m (8 ft) in height should be present within sight distance triangles.

Low shrubs or plants not exceeding a height of 0.6 m (2 ft) are appropriate on the approaches to a signalized intersection, either on the median, or along the edge of the roadway. These should not be allowed to overhang the curb onto the pavement nor interfere with the movement of pedestrians. All planting should have an adequate watering and drainage system, or should be drought resistant. FHWA's report *Vegetation Control for Safety* provides additional guidelines and insight.⁽⁸⁴⁾

8.1.9 Enforcement, Education, and Maintenance

Medians introduce little in the way of unique enforcement or education issues for motor vehicles. Pedestrians may need assistance through the use of signs or other methods to make them aware of one-stage versus two-stage crossings, particularly in communities that have both types of crossings at their signalized intersections.

Typical maintenance procedures will apply to medians. Landscaping should be maintained so as not to obstruct sight distance.

8.1.10 Summary

Table 38 summarizes issues associated with providing median treatments.

Table 38. Summary of issues for providing median treatments.

Characteristic	Potential Benefits	Potential Liabilities
Safety	Safety results are mixed with respect to median width.	
Operations	Signalized directional crossovers can operate more efficiently than unsignalized directional crossovers.	Narrow medians may create storage problems.
Multimodal	Medians of moderate width can allow pedestrians to cross in one or two stages, depending on ability.	Overly wide medians may require all pedestrians to cross in two stages, significantly increasing pedestrian delay. Narrow medians may require long one-stage crossings.
Physical		Changes to median width may have a substantial physical impact upstream and downstream of the intersection.
Socioeconomic		Access control upstream or downstream of the intersection may create challenges.
Enforcement, Education, and Maintenance		Education on the use of pedestrian push buttons in the median may be considered. Landscaping in the median may require maintenance.

8.2 ACCESS MANAGEMENT

Practical experience and recent research indicate that controlling access on a roadway can have a positive impact on both traffic operation and safety. Access management is a key issue in planning and designing roadways so they perform according to their functional classification.

The topic of access management is growing and exceeds the space that this guide can provide. More information on access management can be found in a number of references, including AASHTO's *A Policy on Geometric Design of Highways and Streets*,⁽³⁾ *NCHRP 420: Impacts of Access Management Techniques*,⁽⁸⁵⁾ ITE's *Transportation and Land Development*,⁽⁸⁶⁾ and TRB's *Access Management Manual*.⁽⁸⁷⁾ Several States, including Colorado and Florida, also have extensive guidance on access management. This section focuses on the operational and safety effects of unsignalized intersections (both public streets and private driveways) located within the vicinity of signalized intersections.

8.2.1 Description

Access management plays an important role in the operation and safety of arterial streets where both mobility of through traffic and access to adjacent properties are needed. Studies have repeatedly shown that improvements in access management improve safety and capacity, and also that roadways with poor access management have safety and operations records worse than those with better control of access. Treatments to improve access management near intersections (within 75 m (250 ft) upstream or downstream) include changes in geometry or signing to close or combine driveways, provide turn lanes, or prohibit turn movements.

AASHTO presents a number of principles that define access management techniques.⁽³⁾

- Classify the road system by the primary function of each roadway.

- Limit direct access to roads that have higher functional classifications.
- Locate traffic signals to emphasize through movements.
- Locate driveways and major entrances to minimize interference with traffic operations.
- Use curbed medians and locate median openings to manage access movements and minimize conflicts.

Access management works best when combined with land use and zoning policies. Parking lot placement behind urban and suburban shopping and community attractions can minimize the need to mitigate traffic movements.

8.2.2 Applicability

Intersection problems that indicate an improvement in access management may be desirable include delay to through vehicles caused by vehicles turning left or right into driveways, and rear-end or angle crashes involving vehicles entering or leaving driveways.

8.2.3 Design Features

To understand the effects of a signalized intersection on access management upstream and downstream of the intersection, the functional area of the signalized intersection, shown in figure 62, needs to be determined. The functional area is larger than the physical area of the intersection because it includes several items, as shown in figure 63:⁽⁸⁷⁾

- Distance $d1$: Distance traveled during perception-reaction time as a driver approaches the intersection, assuming 1.5 s for urban and suburban conditions and 2.5 s for rural conditions.
- Distance $d2$: Deceleration distance while the driver maneuvers to a stop upstream of the intersection.
- Distance $d3$: Queue storage at the intersection.
- Distance immediately downstream of the intersection so that a driver can completely clear the intersection before needing to react to something downstream (stopping sight distance is often used for this).

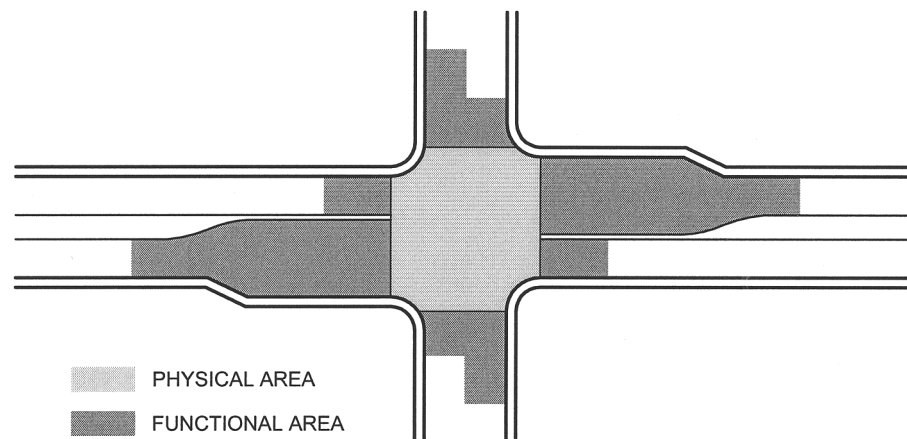


Figure 62. Comparison of physical and functional areas of an intersection.⁽⁸⁷⁾

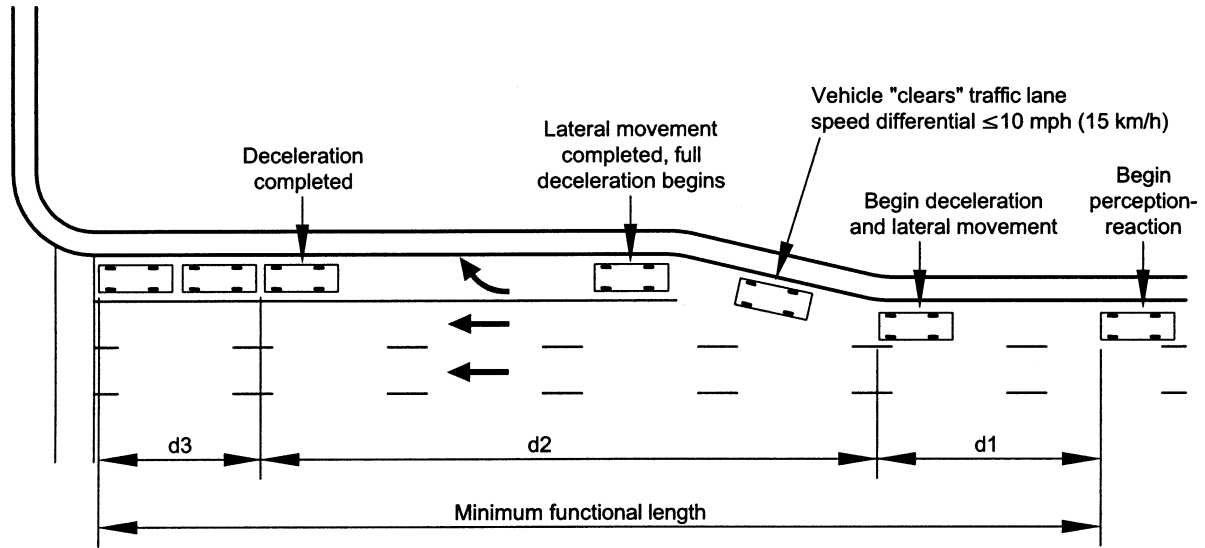


Figure 63. Diagram of the upstream functional area of an intersection.⁽⁸⁷⁾

When two signalized intersections are in proximity to each other, their overlapping functional areas may result in varying levels of access that might be considered between the two intersections, as shown in figure 64. As the figure demonstrates, the functional areas of nearby signalized intersections affects the location and extent of feasible access. Ideally, driveways with full access should be located in the area clear of the functional areas of both signalized intersections. However, signalized intersections are often located close enough to each other that the upstream functional area of one intersection partially or completely overlaps with the upstream functional area of the other. In these cases, there is no clear area between the two intersections where a driveway can operate without infringing upon the functional area of one of the signalized intersections. As such, it is important to apply sound engineering judgment to determine where and if driveway access should be allowed. Some important considerations in the evaluation would include the volume of traffic using the driveway, the type of turning maneuvers that will be most prominent, the type of median present, potential conflicts with and proximity to other driveways, and the volume of traffic on the major street.

Access points that are clear of only one of the two signalized intersections would likely perform best from a safety perspective if restricted to right-in, right-out operation. However, in urban areas, this may not always be practical or may create other problems at downstream intersections, so again it is important to apply sound engineering judgment. In some cases, the two signalized intersections may be so close together that any access would encroach within the functional area of the intersection. These situations are likely to be candidates for either partial or full access restriction. It is important to note that driveways should not be simply eliminated based on simple guidelines but rather should be evaluated on a case-by-case basis with consideration of the broader system effects. When driveways are closed without any regard to the system effects, there is a high potential that the problem will be transferred to another location. Finally, as a general guideline, the functional area of an intersection is more critical along corridors with high speeds (70 km/h (45 mph) or greater) and whose primary purpose is mobility.

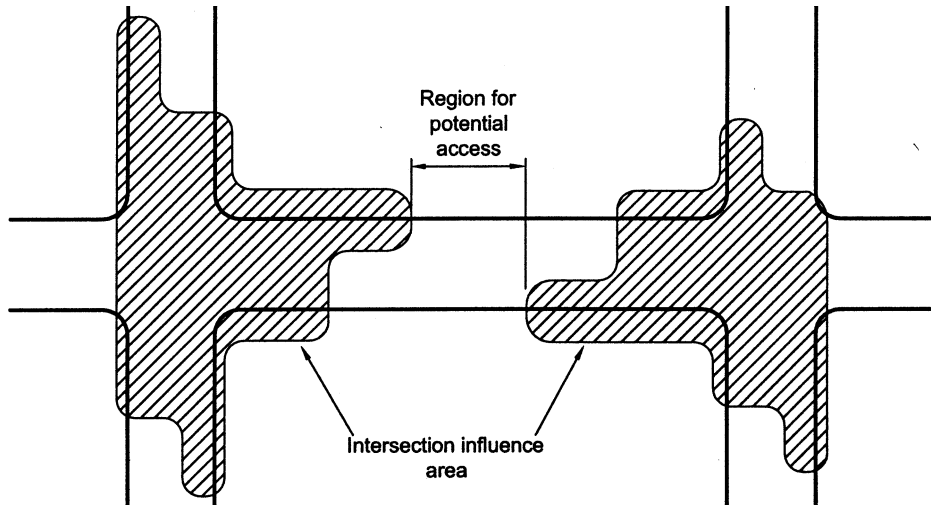
Improvements to the current access to properties adjacent to an intersection area can be implemented by:

- Closing, relocating, or combining driveways.

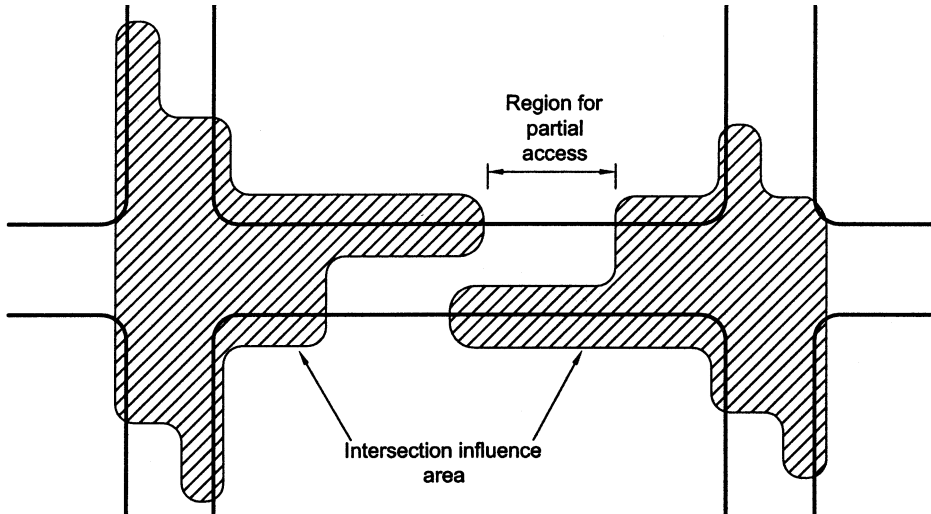
- Restricting turning movements through median treatments, using driveway treatments, and/or using signing.

As discussed previously, where access is restricted, the redirection of driveway traffic needs to be considered. Two of the more typical options are:

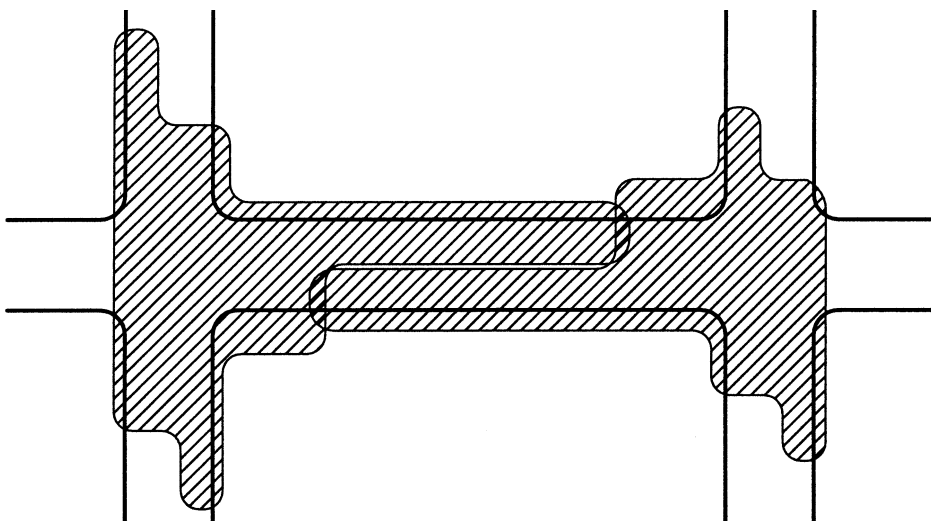
- Require drivers to make a U-turn at a downstream, signalized intersection (figure 65). This requires adequate cross-section width to allow the U-turn and sufficient distance to weave across the through travel lanes. In addition to increasing the traffic volumes at the signalized intersection, U-turns also decrease the saturation flow rate of the left-turn movement. These combined effects potentially decrease the available capacity at the signalized intersection if the affected left-turn movement is a critical movement at the intersection.
- Create a midblock opportunity for drivers to make an unsignalized U-turn maneuver via a directional median opening (figure 66). A study in Florida evaluated the safety effect of these directional median openings on six-lane divided arterials with large traffic volumes, high speeds, and high driveway/side-street access volumes.⁽⁸⁸⁾ This study found a statistically significant reduction in the total crash rate of 26.4 percent as compared with direct left turns.



(a) Minimal amount of potential adverse effects due to adjacent signalized intersections.



(b) Moderate amount of potential adverse effects due to adjacent signalized intersections.



(c) Substantial amount of potential adverse effects due to adjacent signalized intersections.

Figure 64. Access points near signalized intersections. (adapted from 87, figure 8-15)

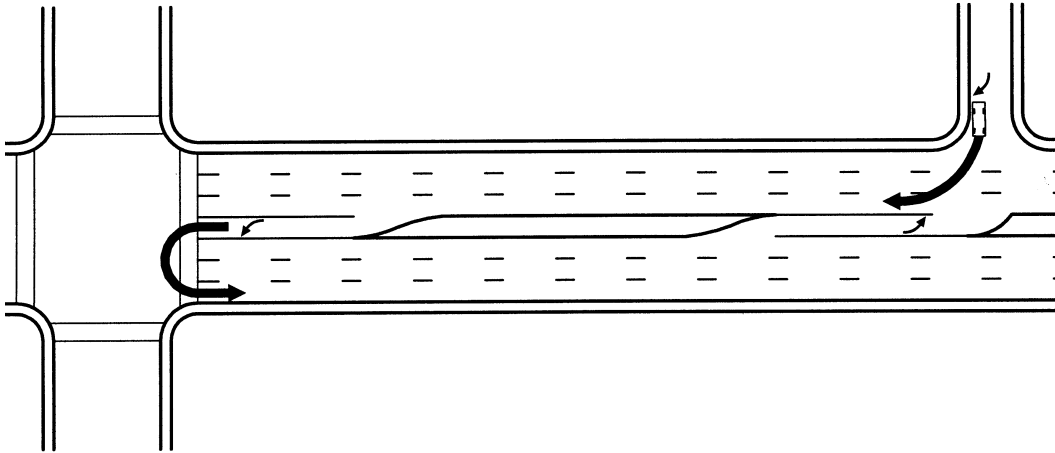


Figure 65. Access management requiring U-turns at a downstream signalized intersection.

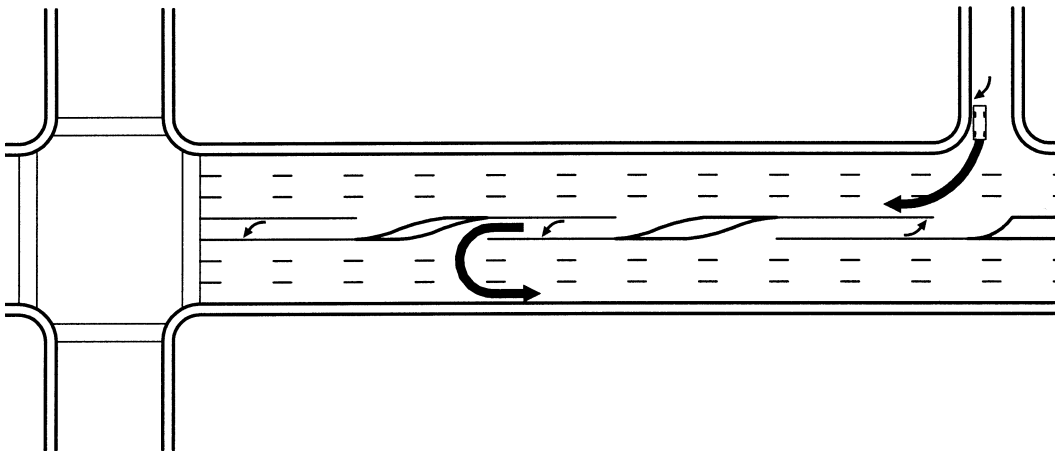


Figure 66. Access management requiring U-turns at an unsignalized, directional median opening.

Note that the conversion of an existing full-access point to right-in/right-out operation has both advantages and disadvantages. The advantages of right-in/right-out operation include:

- Removal of movements from the functional area of the signalized intersection. This reduces conflicts near the signalized intersection and improves capacity by minimizing turbulence.
- Better operation for the driveway. Eliminating left turns out of the driveway generally reduces delays for the driveway movements.

Disadvantages include:

- Increase in U-turn movements at signalized intersections or at other unsignalized locations. This may reduce the available capacity at the intersection and increase delay. This may also increase the potential for left-turn crashes at the location of the U-turn.

- Increase in arterial weaving. This may happen as the driveway movement attempts to get into position to make the U-turn.
- Potential for increased demand for left turns at other driveways serving the same property.

As with other access management treatments, involvement of property owners in the decisionmaking and design process is key to the success of the project.

8.2.4 Safety Performance

In general, an increase in the number of access points along a roadway correlates with higher crash rates. Specific relationships vary based on specific roadway geometry (lane width, presence or absence of turn lanes, etc.) and traffic characteristics.

Table 39 presents a summary of the relative crash rates for a range of unsignalized intersection access spacing. As can be seen, doubling access frequency from 6 to 12 access points per km (10 to 20 access points per mi) increases crash rates by about 40 percent. An increase from 6 to 37 access points per km (10 to 60 access points per mi) would be expected to increase crash rates by approximately 200 percent. Generally, each additional access point per mile along a four-lane roadway increases the crash rate by about 4 percent (see also references 89 and 90).

Table 39. Relative crash rates for unsignalized intersection access spacing.*

Unsignalized Access Points Spacing**	Average Spacing***	Relative Crash Rate****
6 per km (10 per mi)	322 m (1056 ft)	1.0
12 per km (20 per mi)	161 m (528 ft)	1.4
19 per km (30 per mi)	107 m (352 ft)	1.8
25 per km (40 per mi)	80 m (264 ft)	2.1
31 per km (50 per mi)	64 m (211 ft)	2.4
37 per km (60 per mi)	54 m (176 ft)	3.0
44 per km (70 per mi)	46 m (151 ft)	3.5

*Source: Reference 87, as adapted from 85.

**Total access connections on both sides of the roadway.

*** Average spacing between access connections on the same side of the roadway; one-half of the connections on each side of the roadway.

**** Relative to the crash rate for 6.2 access points per km (10 access points per mi).

8.2.5 Operational Performance

The reduction of access along an arterial street has the potential to improve traffic operations. For example, urban arterials with a high degree of access control function 30 to 50 percent better than the same facility with no control.⁽⁹¹⁾ Improved access management also has been shown to improve LOS.⁽⁹²⁾

Access points close to a signalized intersection can reduce the saturation flow rate of the signalized intersection. Research has determined that the amount of reduction depends on the corner clearance of the driveway, the proportions of curb-lane volume that enter and exit the driveway, and the design of the driveway itself.⁽⁹³⁾

However, as indicated earlier, it is important to evaluate the impact of access control on the upstream and downstream intersections, which may experience a significant increase in U-turns or other types of turning movements. For example, if there is adequate capacity to accommodate the turning movements at midblock access driveways and no safety problems have been identified, eliminating the left-turn movements and converting them to U-turns at signalized intersections would likely degrade the operational performance of the arterial because less green time will be available for through traffic.

8.2.6 Multimodal Impacts

Access treatments that reduce the number of driveways or restrict turning movements at driveways also reduce the number of potential conflicts for pedestrians and bicycles near a signalized intersection. In addition, a median treatment used as part of an overall access management strategy may also provide the opportunity for a midblock signalized or unsignalized pedestrian crossing. It would be important to evaluate whether the access treatments being considered would result in a significant increase in operating speed on the facility, as increases in speed have a negative impact on both pedestrians and bicyclists that should be considered in the evaluation.

8.2.7 Physical Impacts

Addition of turn lanes for property access will increase the footprint of the intersection area. Turn restrictions should not have any effect on the physical size of an area, but may add a vertical element to the intersection (if, for example, a raised curb or flexible delineators are used to prohibit left turns). These should not present difficulties for pedestrians with mobility impairments, nor obstruct sight distance.

8.2.8 Socioeconomic Impacts

A review of the literature indicates inconsistency in the socioeconomic effects of access management. Surveys conducted in Florida reported a relatively low rate of acceptance of access management: most drivers felt that the inconvenience of indirect movements offset the benefits to traffic flow and safety. Businesses also were unresponsive: 26 percent reported a loss in profits, and 10 to 12 percent reported a large loss.⁽⁹⁴⁾ Conversely, experience in Iowa indicates rapid growth in retail sales after access management projects were completed. An opinion survey conducted among affected motorists indicated⁽⁹²⁾ that a strong majority supported all projects but one.

The reactions of drivers, property owners, pedestrians, and others concerned with access to properties adjacent to intersections would be expected to vary widely. Access management strategies should be considered only in the context of a roadway corridor with the approval and backing of those affected.

Relocation or closing of driveways should be part of a comprehensive corridor access-management plan. The optimal situation is to avoid driveway conflicts before they develop. This requires coordination with local land use planners and zoning boards in establishing safe development policies and procedures. Avoidance of high-volume driveways near congested or otherwise critical intersections is desirable.

Highway agencies also need to have an understanding of the safety consequences of driveway requests. The power of a highway agency to modify access provisions is derived from legislation that varies in its provision from State to State. Highway agencies generally do not have the power to deny access to any particular parcel of land, but many do have the power to require, with adequate justification, relocation of access points. Where highway agency powers are not adequate to deal with driveways close to intersections, further legislation may be needed.

8.2.9 Enforcement, Education, and Maintenance

Periodic enforcement may be needed to ensure that drivers obey restrictions at driveways where such restrictions cannot be physically implemented with raised channelization, such as signed prohibitions.

Education other than appropriate signing should not be needed when implementing changes to access.

8.2.10 Summary

Table 40 summarizes issues associated with providing access management.

Table 40. Summary of issues for providing access management.

Characteristic	Potential Benefits	Potential Liabilities
Safety	Fewer access points generally result in a lower crash rate along a corridor.	None identified.
Operations	Fewer access points generally result in smoother operation of a corridor.	An increased number of U-turns at a signalized intersection due to access management may reduce the overall capacity of the intersection.
Multimodal	Fewer access points reduce the number of potential conflicts for bicycles and pedestrians.	Potential increases in operating speed along the arterial may negatively impact safety relative to bicycle and pedestrian modes.
Physical	None identified.	Turn restrictions may require adding horizontal and vertical features to driveways.
Socioeconomic	Socioeconomic benefits are mixed, with some studies reporting economic improvement and others reporting economic losses.	Both economic improvement and economic losses have been reported.
Enforcement, Education, and Maintenance	None identified when raised channelization is used.	Periodic enforcement may be needed where signs are used instead of raised channelization.

8.3 SIGNAL COORDINATION

8.3.1 Description

Drivers may have difficulty making permissive turning maneuvers at signalized intersections (e.g., permissive left turns, right turn on red after stop) because of lack of gaps in through traffic. This can contribute to both operational and safety problems. Left-turning vehicles waiting to turn can block through traffic, even if a left-turn lane is provided. This can lead to rear-end crashes between turning and through vehicles. Collisions may also occur when left-turning drivers become impatient and accept a gap that is smaller than needed to complete a safe maneuver. Such collisions could be minimized if longer gaps were made available. (This could also be accomplished through turn prohibitions and changes in signal phasing, although this particular treatment does not address these potential countermeasures.)

One method of providing longer gaps is to coordinate adjacent traffic signals to promote platooning of vehicles. Signals within 0.8 km (0.5 mi) of each other on a major route, or in a network of major routes, should be coordinated; signals spaced farther than 0.8 km (0.5 mi) may be candidates for coordination if platooning can be maintained. Signal progression can help improve driver expectancy of changes in right-of-way assignment due to signal changes. Increased platooning of vehicles can create more defined gaps of increased length for permissive vehicle movements at intersections and can result in improved intersection operation. Increased platooning of vehicles may also result in a decrease in rear-end crashes. Effective coordination of signals should reduce the required number of stops for the higher priority movements (presumably the major street through movement).

8.3.2 Applicability

Signal coordination may be applicable for intersections where:

- Rear-end conflicts/collisions are occurring due to the higher probability of having to stop at each light.

- Lack of coordination is causing unexpected and/or unnecessary stopping of traffic approaching from adjacent intersections.
- Congestion between closely spaced intersections is causing queues from one intersection to interfere with the operation of another.

8.3.3 Safety Performance

Apart from its operational benefits, signal coordination is known to reduce vehicle conflicts along corridors where traffic signals are coordinated. Largely, it reduces the number of rear-end conflicts, as vehicles tend to move more in unison from intersection to intersection.

Studies have proven the effectiveness of signal coordination in improving safety. The ITE *Traffic Safety Toolbox: A Primer on Traffic Safety* cites two studies of coordinated signals with intersection crash frequencies that dropped by 25 and 38 percent.⁽⁹⁵⁾ One study showed a decrease in crash rates for midblock sections as well. A study on the effectiveness of traffic signal coordination in Arizona concluded that there is a small but significant decrease in crash rates on intersection approaches after signal coordination.⁽⁹⁶⁾ Crashes along the study corridor decreased 6.7 percent. Another study of the safety benefits of signal coordination carried out in Phoenix compared coordinated signalized intersections to uncoordinated signalized intersections citywide. The coordinated intersections were found to have 3 to 18 percent fewer total collisions, and 14 to 43 percent fewer rear-end collisions.⁽⁹⁷⁾

Selected findings of safety benefits associated with signal coordination are shown in table 41.

Table 41. Selected findings of safety benefits associated with signal coordination or progression.

Treatment	Finding
Signal Coordination ⁽⁹⁷⁾	3 to 18% estimated reduction in all collisions along corridor 14 to 43% estimated reduction in rear-end collisions along corridor
Provide Signal Progression ⁽⁹⁸⁾	10 to 20% estimated reduction in all collisions along corridor

8.3.4 Operational Performance

The potential benefits of coordination are directly related to the traffic characteristics and spacing of intersections. Coordinated operation works best when traffic arrives in dense platoons. These platoons occur more frequently when the intensity of traffic volume between intersections increases and distance between intersections decreases, to a practical limit. Selection of the system cycle length defines the relationship that allows coordinated operations between the intersections, while the offset represents the difference in start times for the through green at adjacent intersections.

A key to success in signal coordination is the appropriate spacing of the signals. Signals within a half-mile (or sometimes even more if platooning can be maintained) of each other should be coordinated. As with all signals, coordinated signals too close together can present problems when drivers focus on a downstream signal and do not notice the closer signal they are approaching, or the proceed through a green signal and are not able to stop for a queue at a signal immediately downstream. Dispersion of platoons can occur if signals are spaced too far apart, resulting in inefficient use of signal coordination and loss of any operational benefit. Operations on cross streets may be negatively impacted. The Colorado Access Demonstration Project concluded that 0.8-km (0.5-mi) spacing could reduce vehicle hours of delay by 60 percent and vehicle-hours of travel by over 50 percent compared with signals at one-quarter mile intervals with full median openings between signals (reference 87, adapted from reference 99).

Grouping the signals to be coordinated is a very important aspect of design of a progressive system. Factors that should be considered include geographic barriers, volume-to-capacity ratios,

and characteristics of traffic flow (random versus platoon arrivals). When systems operating on different cycle lengths are adjacent to or intersect each other, changes to provide a uniform cycle length appropriate for both systems should be considered, so that the systems can be unified, at least for certain portions of the day. Half-cycles or double cycles should also be considered for some locations if that facilitates coordination.

8.3.5 Multimodal Impacts

Signal coordination, by providing for a more orderly flow of traffic, may aid pedestrians in anticipating vehicle movements, lessening the likelihood of a pedestrian-vehicle conflict. In addition, in some cases it may be possible to provide progression for pedestrians in one or both directions along with vehicle progression.

8.3.6 Physical Impacts

No particular physical needs have been identified.

8.3.7 Socioeconomic Impacts

Signal coordination will also reduce fuel consumption, noise, and air pollution, by reducing the number of stops and delays.

8.3.8 Enforcement, Education, and Maintenance

Signals working in coordination should reduce excessive speed, as motorists realize that they cannot “beat” the next traffic signal. Incidents of aggressive driving should be reduced as well.

Signal timing plans need to be updated as traffic volumes and patterns change. This should be factored into periodic maintenance of the traffic signal.

8.3.9 Summary

Table 42 summarizes the issues associated with providing signal coordination.

Table 42. Summary of issues for providing signal coordination.

Characteristic	Potential Benefits	Potential Liabilities
Safety	Fewer rear-end and left-turn collisions.	May promote higher speeds.
Operations	Improves traffic flow.	Usually longer cycle lengths.
Multimodal	May reduce pedestrian-vehicle conflicts.	May result in longer pedestrian delays due to longer cycle lengths.
Physical	No physical needs.	None identified.
Socioeconomic	Reduces fuel consumption, noise, and air pollution.	None identified.
Enforcement, Education, and Maintenance	May result in less need for speed enforcement.	Signal timing plans need periodic updating.

8.4 SIGNAL PREEMPTION AND/OR PRIORITY

8.4.1 Description

One difficulty in understanding preemption and priority is the lack of standard terms in current practice and the multiple approaches that have been employed to date. The recent development

in the Signal Control and Prioritization (SCP) standard has provided some guidance, but some detail will be provided here.

Preemption is primarily related to the transfer of the normal control (operation) of traffic signals to a special signal control mode for the purpose of servicing railroad crossings, emergency vehicle passage, mass transit vehicle passage, and other special tasks, the control of which requires terminating normal traffic control to provide the serve the special task.

Priority is defined by the preferential treatment of one vehicle class (such as a transit vehicle, emergency service vehicle, or a commercial fleet vehicle) over another vehicle class at a signalized intersection without causing the traffic signal controllers to drop from coordinated operations. Priority may be accomplished by a number of methods, including changing the beginning and end times of greens on identified phases, changing the phase sequence, or including special phases, all without interrupting the general timing relationship between specific green indications at adjacent intersections.

8.4.2 Emergency Vehicle Preemption

A specific vehicle often targeted for signal preemption is the emergency vehicle. Signal preemption allows emergency vehicles to disrupt a normal signal cycle to proceed through the intersection more quickly and under safer conditions. The preemption systems can extend the green on an emergency vehicle's approach or replace the phases and timing for the whole cycle. The MUTCD discusses signal preemption, standards for the phases during preemption, and priorities for different vehicle types that might have preemption capabilities.⁽¹⁾

Several types of emergency vehicle detection technologies are available, and include the use of light, sound, pavement loops, radio transmission, and push buttons to detect vehicles approaching an intersection:

- Light—an emitter mounted on emergency vehicles sends a strobe light toward a detector mounted at the traffic signal, which is wired into the signal controller.
- Sound—a microphone mounted at the intersection detects sirens on approaching vehicles; the emergency vehicles do not need any additional equipment to implement signal priority systems.
- Pavement loop—a standard pavement loop connected to an amplifier detects a signal from a low frequency transponder mounted on the emergency vehicle.
- Push button—a hardwire system is activated in the firehouse and is connected to the adjacent signal controller.
- Radio—a radio transmitter is mounted on the vehicle and a receiver is mounted at the intersection.

Many of these systems have applications in transit-vehicle priority as well as signal preemption for emergency vehicles. Some jurisdictions use signs that alert drivers that a police pursuit is in progress.

8.4.3 Applicability

Preemption/priority is considered where:

- Normal traffic operations impede a specific vehicle group (i.e. emergency vehicles).
- Traffic conditions create a potential for conflicts between a specific vehicle group and general traffic.

8.4.4 Safety Performance

No research is known on the safety implications of emergency vehicle preemption, although it is expected that the number of conflicting movements associated with an emergency vehicle's having to run a red light would be reduced.

Installation of signal preemption systems for emergency vehicles has been shown to decrease response times. A review of signal preemption system deployments in the United States shows decreases in response times between 14 and 50 percent for systems in several cities. In addition, the study reports a 70 percent decrease in crashes with emergency vehicles in St. Paul, MN, after the system was deployed.⁽¹⁰⁰⁾

Signal preemption has also been considered for intersections at the base of a steep and/or long grade. These grades can create a potentially dangerous situation for large trucks if they lose control and enter the intersection at a high speed. Preemption could be used to reduce the likelihood of conflicts between runaway trucks and other vehicles.

8.4.5 Operational Performance

Preemption of signals by emergency vehicles will temporarily disrupt traffic flow. Congestion may occur, or worsen, before traffic returns to normal operation. Data gathered on signal preemption systems in the Washington, DC, metropolitan area suggested that once a signal was preempted, the coordinated systems took anywhere between half a minute to 7 minutes to recover to base time coordination. During these peak periods in more congested areas, vehicles experienced significant delays. Agency traffic personnel indicated that signal preemption seems to have more impacts on peak period traffic in areas where the peak periods extend over longer time periods than it does where peak periods are relatively short.⁽¹⁰⁰⁾

8.4.6 Multimodal Impacts

Priority for transit vehicles can enhance transit operations, reducing delays and allowing for a tighter schedule. Impacts to pedestrians and bicycles are minimal.

8.4.7 Physical Impacts

The key to success is ensuring that the preemption system works when needed by providing clear sight lines between emergency vehicles and detectors. Also, it is important to ensure that vehicles from a variety of jurisdictions will be able to participate in the signal preemption program.

Light-based detectors need a clear line of sight to the emitter on the vehicles; this line could become blocked by roadway geometry, vehicles, foliage, or precipitation. Also, systems from different vendors may not interact well together. Other alarms, such as from nearby buildings, may be detected by a sound-based system.

8.4.8 Socioeconomic Impacts

The reduction in response time by emergency services is a societal benefit, as is more predictable transit service. Costs, particularly when applied to an entire road network, can be significant.

8.4.9 Enforcement, Education, and Maintenance

Preemption directly benefits emergency vehicles, although most police agencies do not use signal preemption. Preempted signals that stop vehicles for too long may encourage disrespect for the red signal, although this has not been reported.

8.4.10 Summary

Table 43 summarizes the issues associated with providing signal preemption and/or priority.

Table 43. Summary of issues for providing signal preemption and/or priority.

Characteristic	Potential Benefits	Potential Liabilities
Safety	Quicker response time for emergency vehicles. On steep grades, preemption could be used to minimize conflicts between runaway trucks and other vehicles.	None identified.
Operations	None identified.	Can be disruptive to traffic flow, particularly during peak hours.
Multimodal	Delay to transit vehicles is reduced.	None identified.
Physical	None identified.	Requires a clear line of sight between the emergency vehicle and the transmitter; other nearby radio systems may be affected or interfere.
Socioeconomic	Lower emergency service response time. More reliable transit service.	Can be costly.
Enforcement, Education, and Maintenance	Improves emergency vehicle response time.	None identified.

CHAPTER 9

INTERSECTION-WIDE TREATMENTS

TABLE OF CONTENTS

9.0	INTERSECTION-WIDE TREATMENTS.....	187
9.1	Pedestrian Treatments.....	187
9.1.1	Reduce Curb Radius.....	187
9.1.2	Provide Curb Extensions	190
9.1.3	Modify Stop Bar Location.....	192
9.1.4	Improve Pedestrian Signal Displays	194
9.1.5	Modify Pedestrian Signal Phasing	196
9.1.6	Grade-Separate Pedestrian Movements	199
9.2	Bicycle Treatments.....	201
9.2.1	Provide Bicycle Box	201
9.2.2	Provide Bike Lanes	202
9.3	Transit Treatments	203
9.3.1	Relocate Transit Stop	203
9.4	Traffic Control Treatments	205
9.4.1	Change Signal Control from Pre-Timed to Actuated	205
9.4.2	Modify Yellow Change Interval and/or Red Clearance Interval	208
9.4.3	Modify Cycle Length	211
9.4.4	Late Night/Early Morning Flash Removal	212
9.5	Street Lighting and Illumination.....	214
9.5.1	Provide or Upgrade Illumination.....	214

LIST OF FIGURES

<u>Figure</u>		<u>Page</u>
67	A curb radius from 4.6 m (15 ft) to 15.2 m (50 ft) increases the pedestrian crossing distance from 18.9 m (62 ft) to 30.5 m (100 ft), all else being equal	188
68	Intersection with curb extension	191
69	Examples of countdown and animated eyes pedestrian signal displays.....	195
70	A pedestrian grade separation treatment	200
71	Typical lighting layouts.....	215

LIST OF TABLES

<u>Table</u>		<u>Page</u>
44	Summary of issues for curb radius reduction	190
45	Summary of issues for curb extensions.....	192
46	Summary of issues for stop bar alterations	194
47	Safety benefits associated with addition of pedestrian signals: Selected findings.....	195
48	Summary of issues for pedestrian signal display improvements.....	196
49	Summary of issues for pedestrian signal phasing modifications.....	199
50	Summary of issues for pedestrian grade separation	201
51	Summary of issues for providing a bicycle box	202
52	Summary of issues for providing bicycle lanes.....	203
53	Summary of issues for near-side/far-side transit stops	205
54	Safety benefits associated with upgrading an intersection from pre-timed to actuated operation: Selected findings	207
55	Summary of issues for providing signal actuation	208
56	Safety benefits associated with modifying clearance intervals: Selected findings	210
57	Summary of issues for modifying yellow/red clearance intervals	211
58	Summary of issues for cycle length modifications.....	212
59	Safety benefits associated with removal of signal from late night/early morning flash mode: Selected findings	213
60	Summary of issues for flash mode removal	214
61	Safety benefits associated with providing illumination: Selected findings	216
62	Summary of issues for providing illumination	217

9. INTERSECTION-WIDE TREATMENTS

This chapter discusses five groups of intersection-wide treatments:

- Pedestrian treatments.
- Bicycle treatments.
- Transit treatments.
- Traffic control treatments.
- Illumination.

9.1 PEDESTRIAN TREATMENTS

Accommodation of pedestrians has a significant effect on both the design and operations of a signalized intersection and should therefore be an integral part of the design process. Key factors to consider are:

- Crossing locations with a high number of pedestrians should be protected (where possible) from conflicting through traffic.
- Crossing distances should be minimized as much as possible.
- Adequate crossing time needs to be provided.
- Pedestrian ramps need to be located within the crosswalk; diagonal ramps are discouraged.
- Pedestrian ramp location and design must meet ADA requirements.

One common way to better accommodate pedestrians and improve their safety is to reduce their crossing distance. Reducing crossing distance decreases a pedestrian's exposure to traffic, which may be particularly helpful to pedestrians who are disabled or elderly. It also reduces the amount of time needed for the pedestrian phase, which reduces the delay for all other vehicular and pedestrian movements at the intersection. Three common methods of reducing pedestrian crossing distance are:

- Curb radius reduction.
- Curb extensions.
- Provision of median crossing islands.

Traffic engineers have also made modifications to the location of the stop bar and crosswalk to try to control where motorists stop on the intersection approach and where pedestrians cross.

Traffic control improvements directly applicable to pedestrians include:

- Improving the signal display to the pedestrian through the use of redundancy, including the use of pedestrian signals, accessible pedestrian signals, and enhancements to the pedestrian signal display.
- Modifying the pedestrian signal phasing.

Each of these treatments is discussed in the following sections; median crossing islands were addressed in chapter 8.

9.1.1 Reduce Curb Radius

Description

Curb radius reduction has been suggested in research because one common pedestrian crash is when right-turning vehicles at intersections strike pedestrians. A wide curb radius

typically results in high-speed turning movements by motorists. Existing guidelines recommend reconstructing the turning radius to a tighter turn to reduce turning speeds, shorten the crossing distance for pedestrians, and improve sight distance between pedestrians and motorists. Figure 67 demonstrates that increasing the curb radius increases pedestrian crossing distance. Tighter turning radii are most important where street intersections are not at right angles.⁽¹⁰¹⁾

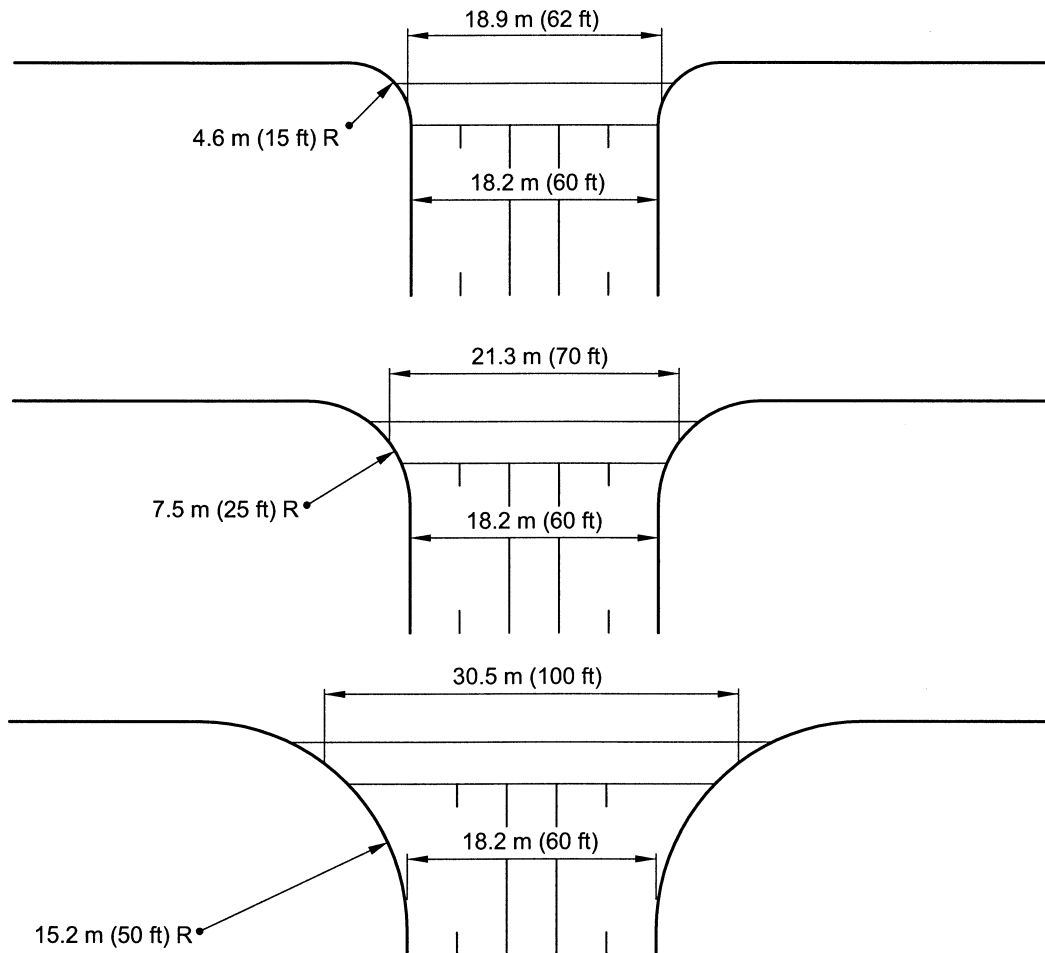


Figure 67. A curb radius increase from 4.6 m (15 ft) to 15.2 m (50 ft) increases the pedestrian crossing distance from 18.9 m (62 ft) to 30.5 m (100 ft), all else being equal.

Applicability

Reducing the curb radii is an appropriate consideration wherever there are pedestrians. Small curb radii facilitate the use of two perpendicular curb ramps rather than a single diagonal ramp (see chapter 3 for further discussion). Note that the need to accommodate the design vehicle may limit how much the curb radius can be reduced. Depending on State vehicle code, it may be acceptable to allow large vehicles to turn right into the second lane (the lane next to the curb lane).

Safety Performance

Reducing the curb radius lowers the speed of right-turning vehicles. It is expected that the frequency of pedestrian-vehicle collisions will be reduced as a result, and any remaining collisions will be of a lesser severity due to the lower speeds involved. However, vehicles turning right will

be forced to decelerate more rapidly in attempting the right turn. This may lead to rear-end conflicts with through vehicles, particularly if a separate right-turn lane is not provided and the through movements have high speeds.

Operational Performance

Reducing pedestrian crossing distance with smaller curb radii reduces the amount of time needed to serve the pedestrian clearance time. This may result in shorter cycle lengths and less delay for all users. However, a curb radius reduction may reduce the capacity of the affected right-turn movement.

Multimodal Impacts

Pedestrians benefit from a shorter crossing distance and the reduced speed of right-turning vehicles.

Larger vehicles and transit may have difficulty negotiating the tighter corner, either swinging out too far into the intersection or having their rear wheels ride up over the curb onto the sidewalk. Caution should be exercised in reducing curb radius if right-turning large trucks or buses are frequent users. It may be necessary to move the stopbar locations on the roadway the trucks are turning into to allow them to briefly swing wide into the opposing lanes.

Physical Impacts

Reducing the curb radius reduces the size of the intersection and allows for additional space for landscaping or pedestrian treatments. Traffic signal equipment may need to be relocated.

Socioeconomic Impacts

Depending on the degree of improvement, low to moderate construction costs will be associated with the reconstruction of the curb radius.

Enforcement, Education, and Maintenance

The effectiveness of this treatment may be enhanced by police enforcement of drivers failing to come to a complete stop on a red signal when making a right turn and/or not yielding to pedestrians in the crosswalk.

Summary

Table 44 summarizes issues associated with curb radius reduction.

Table 44. Summary of issues for curb radius reduction.

Characteristic	Potential Benefits	Potential Liabilities
Safety	Reduction in right-turning vehicle/pedestrian collisions. Fewer right-turn-on-red violations.	May increase right-turning/through vehicle rear-end collisions due to increased speed differential. Large vehicle off-tracking.
Operations	Less overall delay due to reduced time needed to serve pedestrian movement.	Reduction in capacity for affected right-turn movement.
Multimodal	Shorter crossing distance. Facilitates the use of two perpendicular ramps rather than a single diagonal ramp.	May be more difficult for large trucks and buses to turn right.
Physical	Reduces the size of the intersection.	None identified.
Socioeconomic	Low to moderate costs.	None identified.
Enforcement, Education, and Maintenance	None identified.	Enforcement of yielding to pedestrians may be necessary.

9.1.2 Provide Curb Extensions

Description

Curb extensions, also known as “bulbouts” or “neckdowns,” involve extending the sidewalk or curb line into the street, reducing the effective street width. These are often used for traffic calming on neighborhood streets, but the technique is applicable for higher volume signalized intersections. Curb extensions improve the visibility of the pedestrian crosswalk. They reduce the amount of roadway available for illegal or aggressive motorist activities such as failing to yield to pedestrians, making high-speed turns, and passing in the parking lane. It has also been observed that motorists are more inclined to stop behind the crosswalk at a curb extension, and that pedestrians are more inclined to wait on the curb extension than in the street. An example of a curb extension is shown in figure 68.

Application

This treatment would be applicable to urban intersections with heavy pedestrian traffic and a high number of pedestrian collisions. It would not be appropriate at high-speed rural intersections, and caution should be used at intersections with a high proportion of right-turning movements. Curb extensions can be used to terminate parking lanes; care should be exercised if they are used to terminate travel lanes.

The earlier observations on reduced curb radius also apply here.



Photograph Credit: Synectics Transportation Consultants, Inc.

Figure 68. Intersection with curb extension.

Safety Performance

By reducing the pedestrian crossing distance and subsequent exposure of pedestrians to traffic, this treatment should reduce the frequency of pedestrian collisions. A New York City study suggested that curb extensions appear to be associated with lower frequencies and severities of pedestrian collisions.⁽¹⁰²⁾ Curb extensions should also reduce speeds on approaches where they are applied.

Operational Performance

The operational performance effects of curb extensions are similar to those for reduced curb radii. The reduction in pedestrian crossing distance reduces the amount of time needed to serve the pedestrian clearance time. This may result in shorter cycle lengths and less delay for all movements. However, the reduced curb radius resulting from the curb extension may reduce the capacity of the affected right-turn movement. If a right-turn lane is present, the curb radius reduction should not impede through movements.

Because curb extensions are essentially a traffic-calming treatment, they will likely reduce speeds and may possibly divert traffic to other roads; right-turn movements would be particularly affected by this treatment. Emergency services (fire, ambulance, and police) should be consulted if this treatment is being considered.

Multimodal Impacts

Pedestrians benefit greatly from the provision of curb extensions. The curb extension can greatly improve the visibility between pedestrians and drivers. In addition, the reduction in pedestrian crossing distance reduces pedestrian exposure and crossing time.

Bicycle movements and interactions with motor vehicles need to be considered in the design of any curb extensions.

Caution should be used if this treatment is being considered along heavy truck routes. All types of trucks and transit, in particular those needing to turn right at the intersection, would be negatively affected by this treatment.

Physical Impacts

Drainage should be evaluated whenever curb extensions are being considered, as the curb extension may interrupt the existing flow line.

Socioeconomic Impacts

Costs associated with this improvement would be low to moderate.

Enforcement, Education, and Maintenance

No specific effects have been identified.

Summary

Table 45 provides a summary of the issues associated with curb extensions.

Table 45. Summary of issues for curb extensions.

Characteristic	Potential Benefits	Potential Liabilities
Safety	Reduction in right-turning vehicle/pedestrian collisions. Fewer right-turn-on-red violations.	May increase right-turning/through vehicle rear-end collisions due to increased speed differential. Large vehicle offtracking.
Operations	Less overall delay due to reduction in time needed to serve pedestrian movement.	May adversely affect operation if curb extension replaces a travel lane. Right-turn movements delayed. Emergency vehicles may be significantly delayed.
Multimodal	Shorter crossing distance. Facilitates the use of two perpendicular ramps rather than a single diagonal ramp. Better visibility between pedestrians and drivers.	May be more difficult for large trucks and buses to turn right.
Physical	None identified.	Drainage may be adversely affected.
Socioeconomic	Low to moderate costs.	None identified.
Enforcement, Education, and Maintenance	None identified.	None identified.

9.1.3 Modify Stop Bar Location

Description

Visibility is a key consideration for determining the location of stop bars. The FHWA *Pedestrian Facilities Users Guide—Providing Safety and Mobility* suggests the use of advance stop lines as a possible countermeasure.⁽³⁵⁾ At signalized pedestrian crossing locations, the vehicle stop line can be moved 5 to 10 m (15 to 30 ft) further back from the pedestrian crossing than the standard 1.2 m (4 ft) distance to improve visibility of through cyclists and crossing pedestrians for motorists (and particularly truck drivers) who are turning right. Advanced stop lines benefit pedestrians, as the pedestrians and drivers have a clearer view and more time to assess each other's intentions when the signal phase changes.

Applicability

Relocating the stop bar may be applicable to intersections with a high number of right-turn-on-red vehicle/pedestrian collisions.

One reference has recommended that marked crosswalks alone are insufficient in situations:

- Where the speed limits exceeds 64.4 km/h (40 mph).
- On roadways with four or more lanes without a raised median or crossing island that has (or will soon have) an ADT of 12,000 or greater.
- On roadways with four or more lanes with a raised median or crossing island that has (or will soon have) an ADT of 15,000 or greater.⁽³⁵⁾

Safety Performance

One evaluation study found that advance stop lines resulted in reducing right-turn-on-red conflicts with cross traffic; more right-turn-on-red vehicles also make a complete stop behind the stop line. Another study determined that stop line relocation resulted in better driver compliance with the new location and increased elapsed time for lead vehicles entering the intersection. This may decrease the risk of pedestrian collisions involving left-turning vehicles.^(101,103,104) However, placing the crosswalk at least 3 m (10 ft) or more from the cross-street flow line or curb also provides more time to drivers to react for the presence of pedestrian crossing on the street they are about to enter.⁽¹⁰⁵⁾

Operational Performance

Advance stop lines increase the clearance time for vehicles passing through the intersection. As a result, there may be an increase in loss time.

Multimodal Impacts

Advance stop lines keep the opposing lanes at intersections free, allowing trucks to turn wide and thereby allowing smaller curb radii that are more pedestrian friendly.

Physical Impacts

No physical needs have been identified.

Socioeconomic Impacts

Minimal costs are associated with stop bar alterations.

Enforcement, Education, and Maintenance

Enforcement of the relocated stop bars may be necessary.

Summary

Table 46 summarizes the issues associated with stop bar alterations.

Table 46. Summary of issues for stop bar alterations.

Characteristic	Potential Benefits	Potential Liabilities
Safety	Decreased risk of pedestrian collisions involving left-turning vehicles.	None identified.
Operations	None identified.	Increase in vehicular clearance time and loss time.
Multimodal	Relocation of stop bars facilitates turning movements of heavy trucks.	None identified.
Physical	No physical needs identified.	None identified.
Socioeconomic	None identified.	None identified.
Enforcement, Education, and Maintenance	None identified.	Enforcement of the stop bars may be necessary.

9.1.4 Improve Pedestrian Signal Displays

Traffic signals should allow adequate crossing time for pedestrians and an adequate clearance interval based on walking speed. Pedestrian signal enhancements include:

- Separate pedestrian signals (WALK/DON'T WALK).
- Accessible pedestrian signal.
- Countdown displays.
- Animated eyes display.

Application

Chapter 4 provided guidance on the use of pedestrian signals and accessible pedestrian signals. Current thinking suggests that redundancy in information to pedestrians benefits all pedestrians. For example, sighted pedestrians may react more quickly to the WALK indication when provided an audible cue in addition to the pedestrian signal display. Therefore, accessible pedestrian signals may enhance the usability of the intersection for all pedestrians, not just those with visual impairments.

Countdown signals, shown in figure 69a, display the number of seconds remaining before the end of the DON'T WALK interval. The WALKING PERSON symbol and flashing and steady UPRAISED HAND symbol still appear at the appropriate intervals. The countdown signals do not change the way a signal operates; they only provide additional information to the pedestrian. Countdown pedestrian signals have been included in the 2003 MUTCD for optional use.⁽¹⁾

Another innovative pedestrian signal treatment is an animated eyes display, shown in figure 69b. The animated, light-emitting diode (LED) signal head, is used to prompt pedestrians to look for turning vehicles at the start of the WALK indication. The signal head includes two eyes that scan from left to right. Animated eyes have been included in the 2003 MUTCD for optional use with the pedestrian signal WALK indication.⁽¹⁾

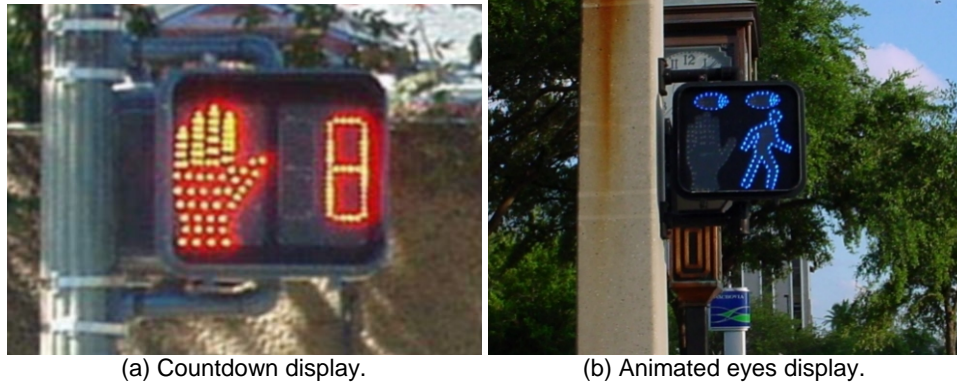


Figure 69. Examples of countdown and animated eyes pedestrian signal displays.

Safety Performance

Collision modification factors listed in table 47 all suggest that pedestrian signals improve safety. However, a number of older studies found that pedestrian signalization does not improve safety.^(106,107) Larger pedestrian signal heads were described in the literature as a treatment to enhance conspicuity; however, no research on the effect on pedestrian safety was found.

Accessible pedestrian signals assist visually impaired pedestrians. Different devices generating audible messages (audible at pedestrian head or audible at push button), vibration at push button, and transmitted messages are in use.⁽¹⁰⁸⁾ A recent study found a 75-percent reduction in the percentage of pedestrians not looking for threats and a similar reduction in conflicts at an intersection equipped with speakers providing messages prompting pedestrians to look for turning vehicles during the walk interval.⁽¹⁰⁹⁾

Countdown displays may reduce vehicle-pedestrian conflicts resulting from pedestrians' attempting to cross the intersection at inappropriate times. Several studies of these pedestrian countdown signals found no statistically significant reductions in pedestrian crash rates. The countdowns did result in a higher percentage of successful crossings by pedestrians (completed their crossing before conflicting traffic received the right of way). (See references 105, 110, 111, and 112.)

Preliminary results from studies of the use of animated-eye displays show increased pedestrian observation of traffic behavior, even after 6 months. Pedestrian/vehicle conflicts appear to decrease at a variety of intersection configurations. Overuse of the device may decrease its effectiveness.^(105,113)

Table 47 presents the results of selected references involving the addition of pedestrian signals.

Table 47. Safety benefits associated with addition of pedestrian signals: Selected findings.

Treatment	Implication
Install WALK/DON'T WALK signals ⁽⁶⁸⁾	15 to 17% estimated reduction in pedestrian collisions
Add pre-timed, protected pedestrian phase ⁽⁹⁸⁾	10% estimated reduction in pedestrian collisions

Operational Performance

These treatments should have a negligible effect on vehicle operations. Use of redundant visual and audible displays may reduce the delay pedestrians experience in initiating their crossing, which may reduce the delay for right-turning vehicles.

Multimodal Impacts

Some treatments described above are of specific benefit to people with visual disabilities, although all pedestrians are likely to benefit from redundancy. They should be considered when modifying intersections.

Apart from pedestrians, there are no specific impacts to other transportation modes.

Physical Impacts

No particular specific physical needs have been identified.

Socioeconomic Impacts

Pedestrian signals and the pedestrian signal enhancements described above have moderate costs.

Enforcement, Education, and Maintenance

As some of the treatments described above have not seen widespread use (e.g., the animated eyes display), some education of the meaning of the devices should be considered upon their introduction to the public.

Summary

Table 48 summarizes the issues associated with pedestrian signal display improvements.

Table 48. Summary of issues for pedestrian signal display improvements.

Characteristic	Potential Benefits	Potential Liabilities
Safety	Give pedestrians improved awareness of traffic.	None identified.
Operations	None identified.	None identified.
Multimodal	All pedestrians, but especially visually impaired pedestrians, are likely to benefit.	None identified.
Physical	None identified.	None identified.
Socioeconomic	None identified.	Some enhancements are expensive.
Enforcement, Education, and Maintenance	None identified.	Education may be necessary.

9.1.5 Modify Pedestrian Signal Phasing

Description

In general, shorter cycle lengths and longer WALK intervals provide better service to pedestrians and encourage greater signal compliance. The MUTCD uses a walk speed of 1.2 m/s (4.0 ft/s) for determining crossing times.⁽¹⁾ However, the *Pedestrian Facilities User Guide* recommends a lower speed of 1.1 m/s (3.5 ft/s), as discussed in chapter 2.⁽³⁵⁾ Other researchers suggest that this speed is still inadequate to meet the needs of older pedestrians. A 15th-

percentile walking speed of older pedestrians has been recommended as the criterion to be used to assess adequacy of crossing time.⁽¹¹⁴⁾

Three options beyond standard pedestrian signal phasing are:

- The leading pedestrian interval.
- The lagging pedestrian interval.
- The exclusive pedestrian phase.

A leading pedestrian interval entails retiming the signal splits so that the pedestrian WALK signal begins a few seconds before the vehicular green. As the vehicle signal is still red, this allows pedestrians to establish their presence in the crosswalk before the turning vehicles, thereby enhancing the pedestrian right-of-way.

A lagging pedestrian interval entails retiming the signal splits so that the pedestrian WALK signal begins a few seconds after the vehicular green for turning movement. The 2001 ITE guide, *Alternative Treatments for At-Grade Pedestrian Crossings*, indicates that this treatment is applicable at locations where there is a high one-way to one-way turning movement and works best where there is a dedicated right-turn lane.⁽¹⁰⁵⁾ This benefits right-turning vehicles over pedestrians by giving the right turners a head start before the parallel crosswalk becomes blocked by a heavy and continuous flow of pedestrians.

An exclusive pedestrian signal phase allows pedestrians to cross in all directions at an intersection at the same time, including diagonally. It is sometimes called a “barn dance” or “pedestrian scramble.” Vehicle signals are red on all approaches of the intersection during the exclusive pedestrian signal phase. The objective of this treatment is to reduce vehicle turning conflicts, decrease walking distance, and make intersections more pedestrian-friendly. The 2001 ITE guide refers to research that indicates that leading intervals were more effective treatments than this scramble pattern.⁽¹⁰⁵⁾

Application

Leading pedestrian phasing may be considered where:

- There is moderate to heavy pedestrian traffic.
- A high number of conflicts/collisions occur between turning vehicles and crossing pedestrians.

Lagging pedestrian phasing may be considered where:

- There is moderate to heavy pedestrian traffic.
- There is right-turn channelization that is heavily used by vehicles.
- A high number of conflicts/collisions occur between right-turning vehicles and crossing pedestrians.

Exclusive pedestrian phasing (scramble) may be considered where:

- There is heavy pedestrian traffic.
- Delay for vehicular turning traffic is excessive due to the heavy pedestrian traffic.
- There are a large number of vehicle-pedestrian conflicts involving all movements.

Note that for any of the three treatments, the use of accessible pedestrian signals is recommended to give people with visual disabilities information of the walk phase in the absence of predictable surging traffic.

Safety Performance

Several studies have demonstrated that imposing of leading pedestrian intervals significantly reduces conflicts for pedestrians.^(102,105,115) Crash analysis conducted at 26 locations with leading

pedestrian intervals in New York City (based on up to 10 years of data) showed that leading pedestrian intervals have a positive effect on pedestrian safety, especially where there is a heavy concentration of turning vehicles. This evidently occurs regardless of pedestrian volume.

None of the studies of lagging pedestrian intervals considered the safety effect of this treatment.

Using exclusive pedestrian intervals that stop traffic in all directions has been shown to reduce pedestrian crashes by 50 percent in some locations (i.e., downtown locations with heavy pedestrian volumes and low vehicle speeds and volumes).^(101,116)

Operational Performance

The leading pedestrian phase will increase delay at the intersection due to a loss in green time. A solution for the issue of loss of green time for vehicles when using a leading pedestrian interval is based on trading the leading pedestrian interval seconds at the beginning of the cycle for seconds at the end of the cycle. The effect would be that all movements get less green time, but that time is optimized. However, this timing was not investigated empirically.⁽¹⁰²⁾

A main operational disadvantage of lagging pedestrian intervals is that they cause additional delays to pedestrians.

With concurrent signals, as described above, pedestrians usually have more crossing opportunities and shorter waits. Unless a system more heavily penalizes motorists, pedestrians will often have to wait a long time for an exclusive pedestrian phase. As a result, many pedestrians will simply choose to ignore the signal and cross if and when a gap in traffic occurs.^(101,116) In addition, an exclusive pedestrian phase may increase the overall cycle length of the intersection, thus increasing delay for all users. On the other hand, an exclusive pedestrian phase removes pedestrians from the vehicular phases, thus increasing vehicular capacity during those phases.

Multimodal Impacts

Pedestrians may become impatient or ignore a lagging pedestrian interval or exclusive pedestrian phase and begin crossing the road during the DON'T WALK phase.

Physical Impacts

No specific physical needs were identified.

Socioeconomic Impacts

Minimal costs are associated with the retiming of the pedestrian signals. The exclusive pedestrian phase, if implemented, may require additional signing and pavement markings to indicate that diagonal crossings may be made (see 2003 MUTCD, section 3B.17⁽¹⁾).

Enforcement, Education, and Maintenance

Where leading or lagging pedestrian phases are being considered, they should be accompanied by police enforcement to ensure that vehicles and pedestrians obey traffic signals.

Summary

Table 49 summarizes the issues associated with pedestrian signal phasing modifications.

Table 49. Summary of issues for pedestrian signal phasing modifications.

Characteristic	Potential Benefits	Potential Disbenefits
Safety	Reduce pedestrian/vehicle collisions.	None identified.
Operations	Exclusive phase: Increased capacity for vehicular turning movements.	Lead phase: Increased vehicular delay. Exclusive phase: Increased vehicular delay due to potentially longer cycle length.
Multimodal	Lead phase: Reduced pedestrian delay.	Lag phase: Increased pedestrian delay. Exclusive phase: Increased pedestrian delay due to potentially longer cycle length.
Physical	None identified.	None identified.
Socioeconomic	Lead or lag phases: Little or no cost.	Exclusive phase: Moderate costs.
Enforcement, Education, and Maintenance	None identified.	Enforcement may be necessary.

9.1.6 Grade-Separate Pedestrian Movements

Description

In some situations, it may be feasible to consider separating pedestrian movements from an intersection. Pedestrian overpasses and underpasses allow for the uninterrupted flow of pedestrian movement separate from the vehicle traffic. However, it increases out-of-direction travel, both horizontally and vertically, for the pedestrian in the process.

Applicability

Pedestrian grade separation, an example of which is shown in figure 70, may be appropriate in situations where:

- An extremely high number of pedestrian/vehicle conflicts or collisions are occurring at the existing crossing location.
- School crossings exist or high volumes of children cross.
- A crossing has been evaluated as a high-risk location for pedestrians.
- Turning vehicles operate with high speeds.
- Sight distance is inadequate.

Usually, a warrant for a grade pedestrian separation is based on pedestrian and vehicle volume, vehicle speed, and area type. Warrants usually differ for new construction projects and existing highways. In the first case, greater opportunities for grade separation are available. In some cases, safety can be a major factor; e.g., New Jersey Department of Transportation guidelines consider pedestrian overpasses and/or underpasses warranted if a safety evaluation indicates that erection of a fence to prohibit pedestrian crossing.⁽¹¹⁷⁾



Photograph Credit: Synectics Transportation Consultants, Inc.

Figure 70. A pedestrian grade separation treatment.

Safety Performance

Pedestrian grade separations ideally should completely remove any pedestrian/ vehicle conflicts at the location in question. However, studies have shown that many pedestrians will not use overpasses or underpasses if they can cross at street level in about the same amount of time, or if the crossing takes them out of their way. Some pedestrians may avoid a pedestrian tunnel or overpass due to personal security concerns.

Operational Performance

Completely eliminating a pedestrian crossing area should improve traffic flow. However, a pedestrian overpass is not likely to be used if it is too inconvenient. Use of a median pedestrian barrier should be considered to reduce midblock crossings and encourage pedestrians to use the grade-separated crossing.

Multimodal Impacts

Pedestrian access and convenience may be negatively affected by grade separation. Pedestrians with disabilities or low stamina may have difficulty with the out-of-direction travel and elevation changes associated with grade separation.

Physical Impacts

Construction of a bridge overpass or tunnel is required. Note that any new or modified pedestrian grade separation treatment must comply with ADA requirements. This may involve adding long ramps with landings at regular intervals or installing elevators.

Socioeconomic Impacts

Grade separation can be very expensive and difficult to implement. As a result, grade separation is usually only feasible where pedestrians must cross high-speed, high-volume arterials.⁽¹⁰¹⁾ In most cases, other treatments are likely to be more cost effective.

Enforcement, Education, and Maintenance

Maintenance issues associated with litter and graffiti are significant with pedestrian overpasses and underpasses. Additional police enforcement may be needed because of the fear of crime in these facilities.

Summary

Table 50 summarizes the issues associated with pedestrian grade separation.

Table 50. Summary of issues for pedestrian grade separation.

Characteristic	Potential Benefits	Potential Liabilities
Safety	Reduced pedestrian-vehicle collisions.	Pedestrians may cross in unexpected locations due to inconvenience of grade separation.
Operations	Improved vehicular capacity.	None identified.
Multimodal	Fewer conflicts between pedestrians and vehicles.	Increased walking distance, delay, and difficulty for pedestrians.
Physical	None identified.	Grade separation structure required, as well as ramps or elevators to meet ADA requirements.
Socioeconomic	None identified.	Significant costs (grade separation).
Enforcement, Education, and Maintenance	None identified.	Graffiti removal and enforcement for personal security may be necessary.

9.2 BICYCLE TREATMENTS

9.2.1 Provide Bicycle Box

Description

A bicycle box uses advance stop bars that are placed on the approach to a signalized intersection, typically in the rightmost lane, at a location upstream from the standard stop bar location. These create a dedicated space for bicyclists—a bicycle box—to occupy while waiting for a green indication. Advance stop bars are used in conjunction with bicycle lanes or other similar bicycle provisions.

Applicability

This treatment may be applicable in situations where vehicle/bicycle collisions have been observed in the past, or vehicle/bicycle conflicts are observed in field observations. The treatment may be considered if a bike lane exists on the approach.

In locations with a high volume of right-turning traffic, use of this treatment may be problematic.

Safety Performance

Such a treatment was found to be effective in Europe, resulting in a 35 percent reduction in through-bicycle/right-turning-vehicle collisions.⁽¹¹⁸⁾

Operational Performance

This treatment is not expected to have a significant effect on traffic operations unless a high volume of right-turning traffic is present.

Multimodal Impacts

Bicycle boxes permit bicyclists to pass other queued traffic on the intersection approach leg, giving them preferential treatment in proceeding through the intersection.

Enforcement, Education, and Maintenance

Concerns with providing a bicycle box include motorist violation of existing stop bar, a lack of uniformity with other intersections, and right-turn-on-red movements.

Summary

Table 51 summarizes the issues associated with providing a bicycle box.

Table 51. Summary of issues for providing a bicycle box.

Characteristic	Potential Benefits	Potential Liabilities
Safety	Potential reduction in collisions between through bicycles and right-turning vehicles.	None identified.
Operations	None identified.	This treatment may not be compatible with a high volume of right-turning traffic.
Multimodal	Bicyclists can bypass queued traffic, thus reducing delay.	None identified.
Physical	None identified.	None identified.
Socioeconomic	None identified.	None identified.
Enforcement, Education, and Maintenance	None identified.	Enforcement of the box may be necessary.

9.2.2 Provide Bike Lanes

Description

While bicycle lanes are frequently used on street segments, AASHTO cautions against the use of bicycle lane markings through intersections.⁽²¹⁾ Special lanes for bicyclists can cause problems to the extent that they encourage bicyclists and motorists to violate the rules of the road for drivers of vehicles. Specifically, a bike lane continued to an intersection encourages right-turning motorists to stay in the left lane, not the right (bike) lane, in violation of the rule requiring that right turns be made from the lane closest to the curb. Similarly, straight-through, or even left-turning, cyclists are encouraged to stay right.

Some advocate placing the bike lane between the through lane and the right-turn only lane. A right-turn-only lane encourages motorists to make right turns by moving close to the curb (as the traffic law requires). A cyclist going straight can easily avoid a conflict with a right-turning car by staying outside of the right-turn lane. A bike lane to the left of the turn lane encourages bicyclists to stay out of the right-turn lane when going straight.

Applicability

This treatment may be applicable in situations where there are a high number of bicyclists using the road or where bicycle use is being promoted or encouraged.

Safety Performance

Some European literature suggests that bicycle lane markings can increase motorist expectation of bicyclists; one Danish study found a 36-percent reduction in bicycle collisions when these were marked.⁽¹¹⁹⁾ Other research concludes that bicycle paths along arterials typically increase cyclists' vulnerability to a collision at signalized intersections; however, raised and brightly colored crossings reduce the number of bicycle/vehicle conflicts and should improve safety.⁽¹²⁰⁾

Multimodal Impacts

Bicycle lanes delineate roadway space between motor vehicles and bicycles and provide for more predictable movements by each.⁽²¹⁾

Physical Impacts

Bicycle lanes may require additional right-of-way unless width is taken from the existing travel and/or parking lanes, either by lane narrowing or the removal of a lane.

Summary

Table 52 summarizes of the issues associated with providing bicycle lanes.

Table 52. Summary of issues for providing bicycle lanes.

Characteristic	Potential Benefits	Potential Liabilities
Safety	Potential reduction in vehicle/bicycle collisions.	None identified.
Operations	None identified.	None identified.
Multimodal	Bicycle lanes delineate roadway space between motor vehicles and bicycles and provide for more predictable movements by each.	None identified.
Physical	None identified.	Bicycle lanes may require additional right-of-way unless width is taken from existing lanes.
Socioeconomic	None identified.	None identified.
Enforcement, Education, and Maintenance	None identified.	None identified.

9.3 TRANSIT TREATMENTS

9.3.1 Relocate Transit Stop

Placement of bus stops in the vicinity of intersections can have a significant influence on the safety and operational performance. Approximately 2 percent of pedestrian accidents in urban areas and 3 percent in rural areas are related to bus stops.⁽¹²¹⁾ Proper placement and provisions at bus stops can reduce several safety and mobility problems. Traffic engineers often have two choices with regard to bus stop placement in the vicinity of an intersection: on the near side (upstream) or far side (downstream). The 1996 *Transit Cooperative Research Program (TCRP) Report 19: Guidelines for the Location and Design of Bus Stops* provides a comprehensive comparative analysis of far-side, near-side, and midblock placement of bus stops.⁽¹²¹⁾

Application

Relocation of a transit stop to a location upstream of the intersection (near side) should be considered in situations where there is congestion on the far side of the intersection during peak periods.

Relocation of a transit stop to a location downstream of the intersection (far side) should be considered in situations where:

- There is a heavy right-turn movement.

- There have been a number of conflicts between vehicles trying to turn right, through vehicles, and stationary near-side buses, resulting in rear-end and sideswipe collisions.
- There have been a number of pedestrian collisions because pedestrians cross in front of a stationary bus and are struck by a vehicle.

Safety Performance

One advantage of near-side placements is that the bus driver has the entire width of the intersection available to pull away from the curb. Near-side bus placements increases conflicts between right-turning vehicles, through traffic, and the bus itself. When the bus is stopped at the bus stop, traffic control devices, signage, and crossing pedestrians are blocked from view. Vehicles on the adjacent approach to the right may have difficulty seeing past a stopped bus while attempting a right turn on red.

Far-side bus stop placements minimize conflicts between right-turning vehicles and buses. Relocating the bus stop to the far side of the intersection can also improve safety because it eliminates the sight distance restriction caused by the bus and encourages pedestrians to cross the street from behind the bus instead in front of it.⁽¹²²⁾ The 1996 TCRP report recommends a minimum clearance distance of 1.5 m (5 ft) between a pedestrian crosswalk and the front or rear of a bus stop.⁽¹²¹⁾ Finally, the bus driver can take advantage of gaps in the traffic flow that are created at signalized intersections. However, far-side bus stops may cause rear-end collisions, as drivers often do not expect buses to stop immediately after the traffic signal.

In conclusion, as a whole, it would appear that far-side bus stops offer greater overall safety.

Operational Performance

Near-side bus stop placements minimize interference with through traffic in situations where the far side of the intersection is congested. This type of placement also allows the bus driver to look for oncoming traffic, including other buses with potential passengers for the stopped bus. However, if the bus stop is being used for more than one bus, the right and through lanes may be temporarily blocked.

Far-side bus stop placements improve the right-turn capacity of the intersection. Yet they may block the intersection during peak periods by stopping buses or by a traffic queue extending back into the intersection. Also, if the light is red, it forces the bus to stop twice, decreasing the efficiency of bus operations.

Multimodal Impacts

Near-side bus stop placements allow pedestrians to access buses closest to the crosswalk, and allows pedestrians to board, pay the fare, and find a seat while the bus is at a red light. However, placing the bus stops on the near side of intersections or crosswalks may block pedestrians' view of approaching traffic and the approaching drivers' view of pedestrians.⁽¹⁰¹⁾

Physical Impacts

Near-side bus stops/bus shelter placements may interfere with the placement of a red-light camera.

Socioeconomic Impacts

Relocation of a bus stop is a relatively low-cost improvement, unless it involves the relocation of a bus bay and shelter.

Enforcement, Education, and Maintenance

Some jurisdictions have implemented or are considering a yield-to-bus law. If implemented, this would require all motorists to yield to buses pulling away from a bus stop and reduce transit/vehicle conflicts.

Far-side bus bays provide a safe haven for police officers carrying out red light running or speed enforcement and can also facilitate U-turns.

From a driver education point of view, the traffic engineer and transit agency may consider consistently placing the bus stop either on the near side or the far side, so that motorists have an expectation of where the bus is going to stop at all signalized intersections in their jurisdiction.

Summary

Table 53 summarizes of the issues associated with providing near-side or far-side transit stops.

Table 53. Summary of issues for near-side/far-side transit stops.

Characteristic	Potential Benefits	Potential Liabilities
Safety	Right-turning vehicle conflicts (far side). Sight distance issues for crossing pedestrians/vehicles on adjacent approach (far side). Rear-end conflicts (near side).	Right-turning vehicle conflicts (near side). Sight distance issues for crossing pedestrians/vehicles on adjacent approach (near side). Rear-end conflicts (far side).
Operations	Eliminates double stopping (near side).	Right-turn/through lanes may be blocked (near side). Intersection may be blocked (far side).
Multimodal	Passenger can board while light is red (near side). Less walking distance to crosswalk (near side).	None identified.
Physical	None identified.	May interfere with red-light camera placement (near side).
Socioeconomic	None identified.	Relocation (far or near) may be costly if it involves relocation of bus bay/bus shelter.
Enforcement, Education, and Maintenance	Far-side bus bays provide space for enforcement vehicles.	Enforcement of yielding to buses may be necessary.

9.4 TRAFFIC CONTROL TREATMENTS

Intersection-wide traffic control treatments have either operational or safety benefits on all approaches and all movements. Signal coordination improves traffic flow for through traffic and provides gaps for left-turn movements. Signal preemption and priority identifies and accommodates critical movements and users. Signal controller upgrades (from pre-timed to actuated) accommodate intersections where traffic flow is highly variable, reducing delays and driver frustration. Clearance interval adjustments can address a red light running problem. Cycle length can also be adjusted based on the nature of the traffic flow through the intersection. Finally, the advisability of removal of a signalized intersection from late night/early morning flash mode should be evaluated.

9.4.1 Change Signal Control from Pre-Timed to Actuated

Description

Traffic signal control at an intersection may be pre-timed or actuated. This mode of control could be a function of the capabilities of the controller (older controllers may not have actuated capabilities), or it could be a byproduct of the lack of detection at the intersection (for example, a modern controller with full actuated capabilities may be required to run pre-timed if no detection is

in place). The mode of control used can have a profound effect on the operational efficiency and safety of the signalized intersection.

A pre-timed controller operates within a fixed cycle length using preset intervals and no detection. Pre-timed traffic control signals direct traffic to stop and permit it to proceed in accordance with a single predetermined time schedule or series of schedules.

The traffic engineer may want to consider upgrading an intersection from pre-timed to actuated control. These signals service movement based on demand. Actuated signals use detection to respond to vehicle calls and are categorized as either semiactuated or fully actuated. Semiactuated traffic signals have detectors located on the minor approaches and in the left-turn lanes of the major approaches. Fully actuated traffic signals have detection on all approaches.

Selecting the best type of control for a location requires full knowledge of local conditions, but, in general, can be based on:

- Variations in peak and average hourly traffic volumes on the major approaches.
- Variations in morning and afternoon hourly volumes.
- Percentage of volumes on the minor approaches.
- Usage by large vehicles, pedestrians, and bicycles.

Applicability

Converting a signal from pre-timed to actuated may be considered in situations:

- Where fluctuations in traffic cannot be anticipated and thus cannot be programmed with pre-timed control.
- At complex intersections where one or more movements are sporadic or subject to variations in volume.
- At intersections that are poorly placed within a traffic corridor of intersections with pre-timed traffic signals.
- To minimize delay in periods of light traffic.

Safety Performance

Actuated traffic signals provide better service to all movements at an intersection, reducing driver frustration and the likelihood of red light running. However, they also make it more difficult for pedestrians with visual impairments to predict what will happen in the intersection.

There is little research on the effect of signal actuation on collisions, apart from some references from Michigan and New York State (table 54). These references suggest that actuated signalized intersections have fewer collisions than intersections with fixed timing.

Table 54. Safety benefits associated with upgrading an intersection from pre-timed to actuated operation: Selected findings.

Treatment	Finding
Upgrade signal controller ⁽⁹⁸⁾	20 to 22% estimated reduction in all collisions.
Install signal actuation ⁽⁹⁸⁾	20% estimated reduction in all collisions.
Change in signal operations (pre-timed to traffic actuated) ⁽¹²³⁾	28% estimated reduction in all collisions.
	32% estimated reduction in right-angle collisions.
	26% estimated reduction in rear-end/overtaking collisions.
	60% estimated reduction in head-on/sideswipe collisions.
	30% estimated reduction in left-turn collisions.

Operational Performance

Actuated intersections used in appropriate situations, can reduce delays to vehicles, particularly in light traffic situations and for movements from minor approaches.

Actuated traffic control is not necessary in situations where traffic patterns and volumes are predictable and do not vary significantly. They may not be the best choice where there is a need for a consistent starting time and ending time for each phase to facilitate signal coordination with traffic signals along a traffic corridor. Actuated signals are dependent on the proper operation of detectors; therefore, they are affected by a stalled vehicle, vehicles involved in a collision, or construction work. This may disrupt operations at a signalized intersection.

Multimodal Impacts

Pre-timed traffic signals may be more acceptable than traffic-actuated signals in areas where there is large and fairly consistent pedestrian traffic crossing the road. Actuated traffic signals may cause confusion with the operation of pedestrian push buttons. Actuated pedestrian push buttons must be located in appropriate locations and be accessible to be ADA compliant.

Physical Impacts

Detectors are required on the approaches where actuation is needed. Depending on the type of detector, this may create physical impacts (see chapter 4 for further discussion of detector types).

Socioeconomic Impacts

Generally speaking, actuated traffic controllers cost more to purchase and install than pre-timed traffic controllers, although almost all traffic controllers purchased today are capable of actuated operation. Detection can be a significant percentage of the cost of a signalized intersection.

Enforcement, Education, and Maintenance

Pre-timed traffic signals may lead to driver frustration in low-volume situations, as in the late evening/early morning hours, as the driver may be waiting for the signal to change green while no other vehicles are present on the other approaches. This may lead to red light running.

Traffic-actuated signals are more complicated and less easily maintained than pre-timed traffic signals, especially because of detector maintenance needs.

Summary

Table 55 summarizes the issues associated with providing signal actuation.

Table 55. Summary of issues for providing signal actuation.

Characteristic	Potential Benefits	Potential Liabilities
Safety	Improves safety. Reduces driver frustration, red light running.	None identified.
Operations	Provides better service to minor approaches. Accommodates widely fluctuating volumes.	Can sometimes reduce smooth platooning in coordinated systems. Requires proper operation of detectors.
Multimodal	None identified.	May be problematic in high pedestrian areas.
Physical	None identified.	Detectors required.
Socioeconomic	None identified.	Can be costly.
Enforcement, Education, and Maintenance	Enforcement needs may decrease.	Maintenance costs will likely increase to maintain detection.

9.4.2 Modify Yellow Change Interval and/or Red Clearance Interval

Description

The yellow change interval warns approaching traffic of the change in assignment of right-of-way. Yellow change intervals, a primary safety measure used at traffic signals, are the subject of much debate. The yellow change interval is normally between 3 and 6 s. Since long yellow change intervals may encourage drivers to use it as a part of the green interval, a maximum of 5 s is commonly employed. Local practice dictates the length of the change interval.

Current thought is that longer intervals will cause drivers to enter the intersection later and breed disrespect for the traffic signal. One before-and-after study showed that the time vehicles entered the intersection increased with a longer yellow change interval.⁽¹²⁴⁾ Additional research is needed to further understand the effect of lengthening the yellow change interval on driver behavior.

The red clearance interval is an optional interval that follows the yellow change interval and precedes the next conflicting green interval. The red clearance interval provides additional time following the yellow change interval before conflicting traffic is released. The decision to use a red clearance interval is determined based on engineering judgment and assessment of any of the following criteria:

- Intersection geometrics.
- Collision experience.
- Pedestrian activity.
- Approach speeds.
- Local practices.

The red clearance interval is either set by local policy or calculated using an equation that determines the time needed for a vehicle to pass through the intersection. The equation most commonly used is described in various documents⁽¹²⁵⁾ (and chapter 4). As intersections are widened to accommodate additional capacity, the length of the calculated clearance interval increases. This increase may contribute to additional lost time at the intersection, which negates some of the expected gain in capacity due to widening.

Applicability

Modifying the yellow or red clearance interval may be considered where:

- A high number of angle/left-turn collisions occur due to through/left-turning drivers failing to clear the intersection or stop before entering the intersection at onset of the red.
- A high number of rear-end collisions occur because drivers brake sharply to avoid entering the intersection at the onset of the red.
- A high incidence of red-light violations is recorded.

Safety Performance

A 1985 study examined the relationship between the timing of clearance intervals and crash rates.⁽¹²⁶⁾ The study focused on 91 intersections across the United States that represent a variety of intersection characteristics including average approach speed, cross-street width, yellow phase, and all-red phase. Results from a cluster analysis showed that intersections with inadequate clearance intervals (meaning the implied deceleration rate exceeded 1982 *Transportation and Traffic Engineering Handbook* recommendations of 3 m/s² (10 ft/s²)) resulted in either: (1) drivers' entering the intersection without adequate cross-street protection, thus increasing the risk of right-angle collisions; or (2) drivers' braking suddenly to avoid entering the intersection, thus increasing the risk for rear-end collisions. The study concludes that accepted standards for timing clearance intervals are commonly ignored and that improved procedures need to be adopted throughout the United States.

A 1997 paper studied the effects of clearance interval timing on red light running and late exits (vehicles that fail to exit the intersection before the onset of green for the cross-street movement, resulting in a right-of-way conflict).⁽¹²⁷⁾ The clearance interval timing for the intersections that were studied was compared to the recommended timing calculated when using the procedures identified in "Determining Vehicle Change Intervals: A Proposed Recommended Practice."⁽¹²⁸⁾ Results from the study showed that the number of red light running and late exit instances were highest at intersections where clearance intervals were too short. Based on the results of the study, drivers did not appear to become habituated to longer yellow signals or increased all-red periods. The paper concludes by indicating that although the positive influence of a longer clearance interval may partially erode over time, the findings of the research suggest that longer change intervals can provide a sustainable safety benefit.

A 2000 paper⁽¹²⁹⁾ evaluated the potential crash effects associated with modifying clearance intervals to conform with ITE's "Determining Vehicle Change Intervals: A Proposed Recommended Practice."⁽¹²⁸⁾ The study focused on 122 intersections that were randomly assigned to experimental and control groups. During the 3-year period following the implementation of the signal timing changes, the intersections with the modified time experienced an 8 percent reduction in reported crashes, a 12 percent reduction in injury crashes, and 37 percent reduction in pedestrian and bicycle crashes. Given the positive results from the study, the authors conclude that modifying the clearance intervals to conform to the ITE proposed recommended practice should be strongly considered by agencies to reduce the number of crashes.

A Texas study of 12 intersection approaches suggested that red light running frequency is minimized with yellow change intervals between 4.0 and 4.5 seconds.⁽¹³⁰⁾

A Michigan study concerning the adjustment of yellow change intervals and all-red intervals at three intersections showed a significant reduction in red light running violations. All red intervals were lengthened from 0.1 second to 1.6 to 4.0 seconds, according to ITE guidelines. Reductions in red light running violations were significant and some preliminary data appears to suggest that collisions have been reduced as well.⁽¹³¹⁾

Table 56 presents selected findings associated with signal clearance modifications.

Table 56. Safety benefits associated with modifying clearance intervals: Selected findings.

Treatment	Finding
Add all-red clearance interval ⁽⁹⁸⁾	15 to 30% estimated reduction in all collisions.
Increase yellow change interval ⁽⁹⁸⁾	15 to 30% estimated reduction in all collisions.
Retime traffic signal ⁽⁹⁸⁾	10% estimated reduction in all collisions.
Add all-red clearance interval and increase yellow change interval ⁽¹³²⁾	15% estimated reduction in all collisions. 30% estimated reduction in right-angle collisions.

Operational Performance

Extending the yellow and red interval will increase the amount of lost time, decreasing the overall efficiency of the intersection.

Multimodal Impacts

Either extending the yellow and/or red clearance interval or providing a red clearance interval will benefit pedestrians, going them additional time to clear the intersection. The elderly or people with mobility disabilities may benefit substantially.

Physical Impacts

No physical impacts are associated with this treatment.

Socioeconomic Impacts

The treatment has been shown to reduce red light running at a wide variety of signalized intersections. It is a low-cost alternative to the use of police or automated enforcement.

Enforcement, Education, and Maintenance

Local practice varies as to legal movements during the yellow phase. Police, traffic engineering staff, and the public need to be clear and in agreement about what is permissible in their jurisdiction.

Summary

Table 57 summarizes the issues associated with modifying yellow and/or red clearance intervals at signalized intersections.

Table 57. Summary of issues for modifying yellow/red clearance intervals.

Characteristic	Potential Benefits	Potential Liabilities
Safety	Angle collisions are reduced. Left-turn collisions are reduced. Rear-end collisions are reduced.	None identified.
Operations	None identified.	Increased lost time.
Multimodal	The elderly and people with mobility disabilities have more time to cross.	None identified.
Physical	No physical requirements.	None identified.
Socioeconomic	Low-cost alternative to police and automated enforcement.	None identified.
Enforcement, Education, and Maintenance	Red-light enforcement may become less necessary.	None identified.

9.4.3 Modify Cycle Length

Description

The calculation and selection of cycle length requires good judgment on the part of the traffic engineer/analyst. General practice is to have a cycle length between 50 and 120 s. For low-speed urban roads, a shorter cycle length is preferable (50 to 70 s). For wider roadways (over 15 m (50 ft)) with longer pedestrian crossing times (greater than 20 s), or in situations where heavier traffic is present and left-turning vehicles are not being effectively accommodated, a cycle length of 60 to 90 s may be preferable. At high-volume intersections where heavy turning movements are accommodated by multiple phases, a cycle length of 90 to 120 s may be most appropriate.⁽¹³³⁾ However, cycle lengths longer than 120 s may be needed at large intersections to accommodate multiple long pedestrian crossings in combination with heavy turning movements, especially during peak periods.

Safety Performance

Longer cycle lengths may lead to driver frustration and red light running, as it may take several cycles for a motorist to get through the intersection, particularly when attempting a left turn against opposing traffic.

No known research or specific collision modification factors exist for modifying cycle length.

Operational Performance

A cycle length of 90 s is often considered optimum, since lost time is approaching a maximum, capacity is approaching a minimum, and delay is not too great.⁽¹³³⁾ Longer cycle lengths may lead to excessive queuing on the approach and will interfere with turning movements (left- and right-turn channelization) if through traffic is severely backed up.

Conversely, intersection capacity drops substantially when cycle lengths fall below 60 s, as a greater percentage of available time is used up in the yellow and red clearance intervals.

Multimodal Impacts

A shorter cycle length may not provide pedestrians with sufficient time to safely cross the intersection, particularly if it has turning lanes. Conversely, a longer cycle length may encourage impatient pedestrians to cross illegally during the red phase.

Physical Impacts

No physical impacts are associated with the modification of cycle length.

Socioeconomic Impacts

No significant costs are associated with this treatment, apart from labor.

Summary

Table 58 summarizes the issues associated with cycle length modification.

Table 58. Summary of issues for cycle length modifications.

Characteristics	Potential Benefits	Potential Liabilities
Safety	Less red light running (with shorter cycle lengths).	More red light running (with longer cycle lengths).
Operations	Reduction in delay optimized at 90 s.	Excessive queuing (with longer cycle lengths). Inadequate capacity (with cycle lengths that are too short).
Multimodal	None identified.	Inadequate crossing time for pedestrians (with cycle lengths that are too short).
Physical	None identified.	None identified.
Socioeconomic	None identified.	None identified.
Enforcement, Education, and Maintenance	None identified.	More red light running (with longer cycle lengths).

9.4.4 Late Night/Early Morning Flash Removal

Description

Some jurisdictions operate traffic signals in flashing mode during various periods of the night, the week, or for special events. Flashing operation may be of some advantage to traffic flow, particularly with pre-timed signals, when traffic is very light (late evening/early morning hours, or on a Sunday or holiday in an industrial area).

Two modes of flashing operation are typically used: red-red and red-yellow. Red-red (all approaches receive a flashing red indication) is used where traffic on all approaches is roughly the same. In this instance, the intersection operates the same as an all-way stop. Red-yellow (the minor street receives a flashing red indication and the major street receives a flashing yellow indication) is used in situations where traffic is very light on the minor street. In this instance, the intersection operates similar to a two-way stop.

Safety Performance

A 1987 Michigan study involved the conversion of 59 signalized intersections previously operating in late-night/early morning flashing mode.⁽¹³⁴⁾ Late night and early morning collisions before and after the conversion were compared and tested using a paired t-test. Right-angle collisions during when signalized intersections were in flash mode dropped by 91 percent; right-angle injury collisions dropped by 95 percent. Rear-end collisions increased slightly, but the change was not significant.

In a study in Winston-Salem, NC, signals from 20 intersections were taken out of late night/early morning flashing operation.⁽¹³⁵⁾ There was a 78-percent reduction in right-angle

collisions and a 32-percent reduction in all collisions during times the traffic signal had been in flashing mode.

Some studies have indicated a safety benefit of removing traffic signals from flashing mode under some circumstances, as positive control is provided rather than leaving the driver to decide when it is safe to proceed into the intersection.

Selected study findings associated with the removal of a traffic signal from a flashing mode operation (such as during the late-night/early morning time period) are shown in table 59.

Table 59. Safety benefits associated with removal of signal from late night/early morning flash mode: Selected findings.

Treatment	Finding
Remove signal from late night/early morning flash mode ⁽¹³⁵⁾	78% estimated reduction in right-angle collisions during time of previous flashing operation. 32% estimated reduction in all collisions during time of previous flashing operation.

Operational Performance

If the signalized intersection removed from flashing operation is not fully actuated and responsive to traffic demand, there will be a tendency for red-light violations and/or complaints about unnecessary long waits on red signals.

Multimodal Impacts

Removing a traffic signal from a flash mode will require vehicles to come to a complete stop during the red phase. This treatment should give vehicles more time to see, respond, and yield to any pedestrians.

Physical Impacts

No physical impacts are associated with this treatment.

Socioeconomic Impacts

No costs are associated with this treatment.

Enforcement, Education, and Maintenance

When a traffic signal is taken out of flash mode, police enforcement could be undertaken at the location to ensure that habituated drivers are not continuing to proceed through the intersection as if the signal were still operating in flashing mode. The traffic engineer may consider temporary signage/publicity to inform motorists of the change in operations and to explain the safety benefits.

Summary

Table 60 summarizes the issues associated with flash mode removal.

Table 60. Summary of issues for flash mode removal.

Characteristic	Potential Benefits	Potential Liabilities
Safety	Angle collisions are reduced.	None identified.
Operations	None identified.	Increased delay for through traffic.
Multimodal	Motorists forced to yield to pedestrians.	None identified.
Physical	None identified.	None identified.
Socioeconomic	None identified.	None identified.
Enforcement, Education, and Maintenance	None identified.	Enforcement and temporary signage may be needed for a period after conversion.

9.5 STREET LIGHTING AND ILLUMINATION

9.5.1 Provide or Upgrade Illumination

Description

The purpose of roadway lighting is to enhance visibility for drivers, bicyclists, and pedestrians, thereby improving their ability to see each other and the physical infrastructure of the intersection. This allows them to react more quickly and accurately to each other when natural light goes below a certain level—either at night or during bad weather.

Applicability

Intersection lighting should be considered at all signalized intersections. Upgrades may be justified if more collisions than expected are occurring at night, and particularly if the nighttime collisions involve pedestrians, bicyclists, and/or fixed objects.

Design Features

The illumination design at an intersection should meet lighting criteria established by the Illuminating Engineering Society of North America (IESNA) in IESNA RP-8-00, *American National Standard Practice for Roadway Lighting*.⁽⁶³⁾ The basic principles and design values for intersections have been presented previously (chapter 4) and include overall light level and uniformity of lighting.

Some of the factors that affect the light level and uniformity results include:

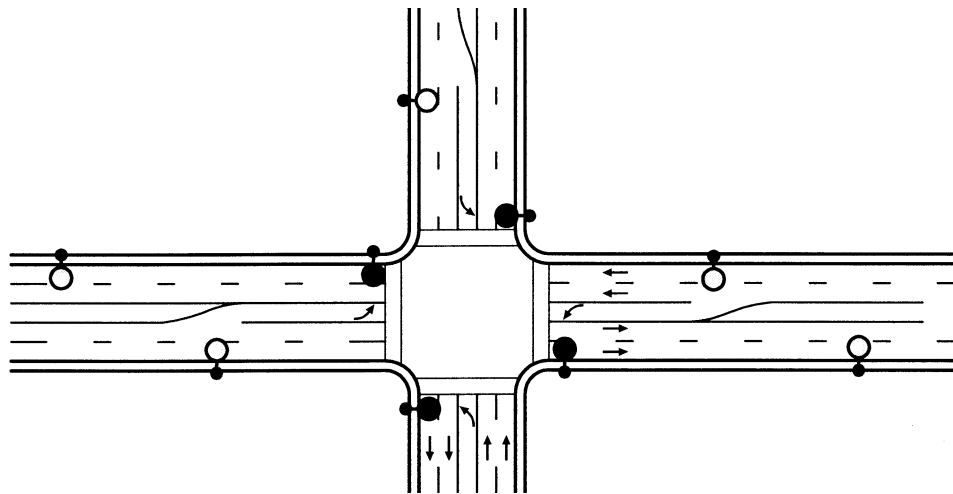
- Luminaire wattage, type, and distribution.
- Luminaire mounting height.
- Pole placement and spacing.

These factors are interrelated. For example, higher mounting heights improve uniformity by spreading the light over a larger area; however, the overall light level decreases unless larger wattages are used or poles are placed closer together. A good illumination design balances these various factors against an overall desire to minimize the number of poles and fixtures (both for cost savings and for minimizing the number of fixed objects in the right-of-way).

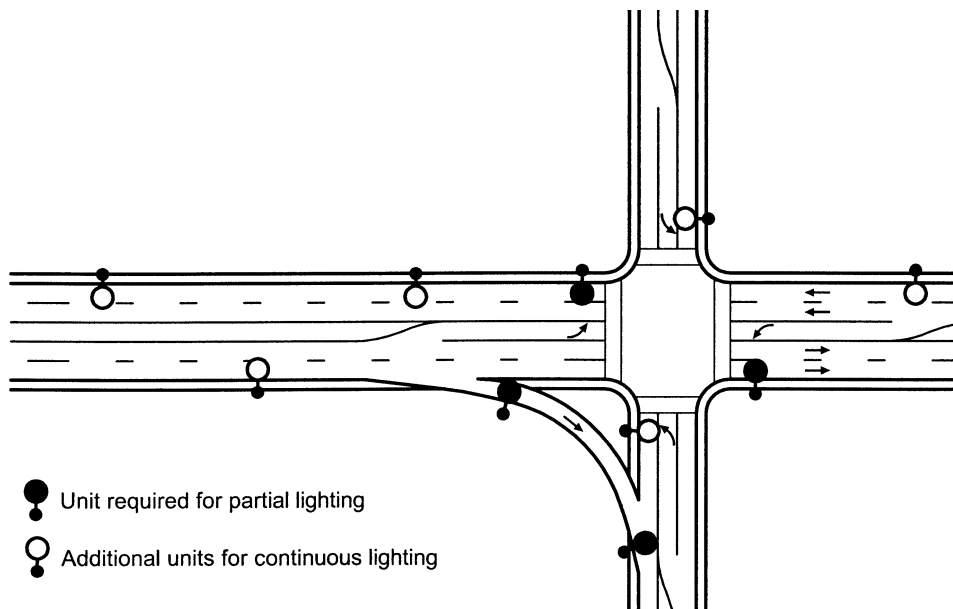
Pole Placement and Spacing

Besides the types of poles and fixtures, the placement is also an important aspect of a good roadway design. Several factors need to be considered in pole placement. First is safety. Most important is to place the pole at an offset distance that can assist in preventing crashes (vehicles and pedestrians). Second is to determine the pole spacing that is most efficacious for the initial

and the long-term maintenance costs and yet still meets the lighting requirement. At intersections, shared use of poles for signal equipment and illumination is recommended. Figure 71 shows examples from RP-8-00 of illumination pole layouts typical at signalized intersections with and without channelized right-turn lanes. However, recent research to improve lighting at midblock pedestrian crosswalks suggests that it may be desirable to locate poles approximately one third to one half the luminaire mounting height back from the crosswalk to improve lighting for pedestrians, which may involve having separate poles for signal equipment and luminaires.⁽¹³⁶⁾ For intersections where separate pedestrian pedestals are provided at the crosswalk, the mast arm poles for vehicle signal heads could be located to be optimal for illumination as well.



(a) Typical lighting layout for intersection without right-turn bypass lane.



- Unit required for partial lighting
- Additional units for continuous lighting

(b) Typical lighting layout for intersection with right-turn bypass lane.

Figure 71. Typical lighting layouts.^(63, figure D3)

Safety Performance

When illumination and visibility are optimal, the chance of nighttime accidents declines, and traffic flow is enhanced. Roadway lighting also increases sight distance, security, and the use of surrounding facilities.

Selected findings from the literature suggest safety improvements associated with adding illumination to an intersection (see table 61).

Table 61. Safety benefits associated with providing illumination: Selected findings.

Treatment	Finding
Add lighting ⁽¹³²⁾	30% reduction in all collisions. 50% reduction in nighttime collisions.
Add lighting ⁽¹³⁷⁾	43% reduction in fatal crashes. 17% reduction in injury crashes.

Operational Performance

There is no documented relationship between illumination and the operational performance of an intersection. The authors believe that illumination likely has little effect on traffic flow, delay, and queuing.

Multimodal Impacts

As noted above, illumination has been demonstrated to reduce pedestrian crashes and provide a more secure environment for all intersection users at night.

Physical Impacts

The provision of illumination typically has little effect on the overall footprint of an intersection. Commonly, combination poles are used to support both signal heads and luminaires, so additional poles are rarely needed in the immediate vicinity of the intersection. However, the recent research cited previously suggests the possibility of improved pedestrian visibility using additional poles upstream from the crosswalk.

Socioeconomic Impacts

Illumination has a positive benefit in reducing the fear of crime at night and in promoting business and the use of public streets at night.⁽⁶³⁾

In addition to the initial capital cost and maintenance of illumination fixtures, illumination requires energy consumption. The Roadway Lighting Committee of IESNA believes that lighting of streets and highways is generally economically practical and that such preventive measures can cost a community less than the crashes caused by inadequate visibility.⁽⁶³⁾ Judicious design of luminaire types, wattages, mounting height, and pole spacing may increase visibility at the intersection without significantly increasing energy costs.

Summary

Table 62 summarizes the issues associated with providing illumination.

Table 62. Summary of issues for providing illumination.

Characteristic	Potential Benefits	Potential Disbenefits
Safety	Reported reductions in nighttime collisions.	None identified.
Operations	None identified.	None identified.
Multimodal	May reduce pedestrian crashes.	None identified.
Physical	Little impact.	None identified.
Socioeconomic	May reduce fear of nighttime crime.	Additional energy consumption.
Enforcement, Education, and Maintenance	None identified.	Maintenance of illumination will be necessary.

CHAPTER 10

ALTERNATIVE INTERSECTION TREATMENTS

TABLE OF CONTENTS

10.0	ALTERNATIVE INTERSECTION TREATMENTS.....	221
10.1	Intersection Reconfiguration and Realignment Treatments	222
10.1.1	Remove Intersection Skew Angle.....	222
10.1.2	Remove Deflection in Travel Path for Through Vehicles.....	225
10.1.3	Convert Four-Leg Intersection to Two T-Intersections	227
10.1.4	Convert Two T-Intersections to Four-Leg Intersection	229
10.1.5	Close Intersection Leg	230
10.2	Indirect Left-Turn Treatments	232
10.2.1	Jughandle.....	232
10.2.2	Median U-Turn Crossover.....	242
10.2.3	Continuous Flow Intersection.....	249
10.2.4	Quadrant Roadway Intersection	256
10.2.5	Super-Street Median Crossover	260
10.3	Grade Separation Treatments	264
10.3.1	Split Intersection.....	265
10.3.2	Diamond Interchange.....	269

LIST OF FIGURES

<u>Figure</u>		<u>Page</u>
72	Illustration of conflict points for a four-leg signalized intersection	222
73	Diagrams of different types of intersection realignment	223
74	Example of deflection in travel paths for through vehicles	226
75	Conflict point diagram for two closely spaced T-intersections.....	228
76	Diagram of a jughandle intersection	233
77	Vehicular movements at a jughandle intersection	233
78	Example of a jughandle intersection.....	234
79	Another example of a jughandle intersection	234
80	Design layout of near-side jughandle	236
81	Design layout of far-side jughandle	237
82	Example of jughandle and associated signing	238
83	Signal phasing of a jughandle intersection	239
84	Conflict point diagram for a four-leg signalized intersection with two jughandles	240
85	Diagram of a median U-turn crossover from the main line.....	242
86	Vehicular movements at a median U-turn intersection.....	243
87	Example of median U-turn signing in Michigan	244
88	Diagram of general placement of a median U-turn crossover.....	245
89	Diagram of a median U-turn crossover from the main line with a narrow median.....	245
90	Conflict diagram for a four-leg signalized intersection with median U-turns.....	247
91	Diagram of a continuous flow intersection.....	250
92	Vehicular movements at a continuous flow intersection.....	250
93	Continuous flow intersection.....	251
94	Displaced left turn at a continuous flow intersection.....	251
95	Signal phasing of a continuous flow intersection.....	252
96	Conflict diagram for a continuous flow intersection with displaced left turns on the major street only	253
97	Diagram of a quadrant roadway intersection.....	257
98	Vehicular movements at a quadrant roadway intersection.....	257
99	Signal phasing of a quadrant roadway intersection.....	258
100	Conflict point diagram for four-leg signalized intersection with quadrant roadway	259
101	Illustration of super-street median crossover.....	261
102	Vehicular movements at a super-street median crossover	261
103	Signal phasing of a super-street median crossover	262

CHAPTER 10 FIGURES, CONTINUED

<u>Figure</u>	<u>Page</u>
104 Conflict diagram for a super-street median crossover.....	263
105 Illustration of a split intersection.....	266
106 Conflict point diagram for a split intersection.....	267
107 Diagram of a single-point interchange.....	270
108 Diagram of a compressed diamond interchange.....	271
109 Typical signal phasing of a single-point interchange.....	271
110 Typical signal phasing of a compressed diamond interchange.....	272
111 Single-point diamond interchange conflict point diagram.....	273
112 Compressed diamond interchange conflict point diagram.....	274

LIST OF TABLES

<u>Table</u>	<u>Page</u>
63 Summary of issues for removing intersection skew.....	225
64 Summary of issues for removing deflection of vehicle path.....	227
65 Number of conflict points at a four-leg signalized intersection compared to two closely spaced T-intersections.....	227
66 Safety benefits of converting a four-leg signalized intersection to two T-intersections: Expert opinion.....	228
67 Summary of issues for converting a four-leg intersection to two T-intersections.....	229
68 Summary of issues for converting two T-intersections to one four-leg intersection.....	230
69 Safety benefits associated with street closures: Selected findings.....	231
70 Summary of issues for closing an intersection approach leg.....	232
71 Number of conflict points at a four-leg signalized intersection compared to a four-leg signalized intersection with a jughandle.....	240
72 Safety benefits of converting a four-leg signalized intersection to a four-leg signalized intersection with two jughandles: Expert opinion.....	240
73 Summary of issues for jughandles.....	242
74 Number of conflict points at a four-leg signalized intersection compared to a four-leg signalized intersection with a median U-turn crossover configuration.....	246
75 Safety benefits of converting a four-leg signalized intersection to median U-turn crossover configuration: Expert opinion.....	247
76 Summary of issues for median U-turn crossovers.....	249
77 Number of conflict points at a four-leg signalized intersection compared to a continuous flow intersection with displaced left turns on the major street only.....	253
78 Safety benefits of converting a four-leg signalized intersection to a CFI: Expert opinion..	254
79 Summary of issues for continuous flow intersections.....	256
80 Number of conflict points at a four-leg signalized intersection compared to a four-leg signalized intersection with a quadrant roadway.....	258
81 Safety benefits of adding a quadrant roadway to a four-leg signalized intersection: Expert opinion.....	259
82 Summary of issues for quadrant roadways.....	260
83 Number of conflict points at a four-leg signalized intersection compared to a super-street median crossover.....	263
84 Safety benefits of converting a four-leg signalized intersection compared to a super-street median crossover: Expert opinion.....	263
85 Summary of issues for super-street median crossovers.....	264
86 Number of conflict points at a four-leg signalized intersection compared to a split intersection.....	267
87 Safety benefits of converting a four-leg signalized intersection to a split intersection: Expert opinion.....	268
88 Summary of issues for split intersections.....	269
89 Number of conflict points at a four-leg signalized intersection compared to a compressed diamond and single-point diamond interchange.....	273
90 Safety benefits of converting a four-leg signalized intersection to a compressed diamond and single-point diamond interchange: Expert opinion.....	275
91 Summary of issues for single-point and compressed diamond interchanges.....	276

10. ALTERNATIVE INTERSECTION TREATMENTS

A recent study has shown that conventional methods of adding capacity to an intersection—adding left-turn, through, and right-turn lanes—have diminishing returns.⁽¹³⁸⁾ For example, if the addition of a second through lane adds 15 years to the life of the intersection before it reaches capacity, the addition of a third through lane adds only 10 years, and a fourth through lane adds only 6 years. Large intersections increase loss time due to longer clearance intervals, protected left-turn phasing, longer pedestrian clearance times, greater imbalances in lane utilization, and potential queue blockages caused by the resulting longer cycle lengths. Each of these issues suggests the need to look for alternative methods to conventional lane additions to solving congestion-related problems.

This chapter describes reconstruction treatments for signalized intersections in three categories: intersection reconfiguration, at-grade indirect movements, and grade separation. Many of these treatments are commonplace; others have seen limited or regional use. The common element in each treatment is the reduction in conflict points at the intersection, which provides safety and operational benefits by reducing the number of phases and conflicting volume at a single location. These reconstruction treatments are often necessary when relatively low-cost treatments (such as improving signal timing and signing or adding an auxiliary lane) do not suffice.

Given that limited data are available regarding the safety of these treatments, a conflict point diagram is provided so that the treatments presented here can be compared to a conventional four-leg signalized intersection (figure 72). At a conventional four-leg signalized intersection, conflict points can be categorized as follows:

- Eight merge and eight diverge conflict points. Collisions associated with merging/diverging movements are rear-end and sideswipe collisions, occurring on a particular leg and involving another vehicle on the same leg.
- Sixteen crossing conflict points. Of these, 12 crossing movements are associated with left-turning vehicles. Collisions associated with this crossing movement occur when a vehicle attempting a left turn at a signal is struck by traffic passing through the intersection on another approach. The remaining four crossing movements involve through movements on two adjacent approaches. Angle collisions may occur as a result of this type of conflict.

Conflict points provide a means to compare the relative safety for vehicles of a typical four-leg signalized intersection to the alternative intersection treatments presented in this chapter. With each of these treatments, an expert opinion is provided stating what the expected change in collisions might be if the alternative treatment were introduced.

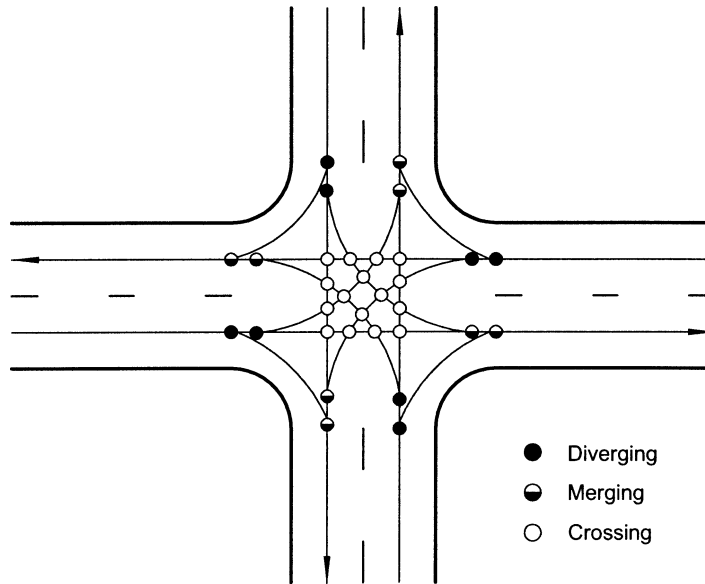


Figure 72. Illustration of conflict points for a four-leg signalized intersection.

10.1 INTERSECTION RECONFIGURATION AND REALIGNMENT TREATMENTS

This section discusses several conventional at-grade treatments that can solve specific intersection problems.

10.1.1 Remove Intersection Skew Angle

Description

The AASHTO policy suggests maintaining an intersection angle of 75 to 90 degrees for new construction.⁽³⁾ Angles as low as 60 degrees are acceptable if cost and other constraints dictate a need for this degree of skew. If reconstructed intersections have a skew angle below 60 degrees, examination of collision rates and patterns may be required.

Signalized intersections may have sight-distance-related safety problems that cannot be addressed inexpensively (such as clearing sight triangles, adjusting signal phasing, or prohibiting turning movements). These may require horizontal or vertical realignment of approaches. Realigning both of the minor-road approaches so that they intersect the major road at a different location or a different angle can help address horizontal sight distance issues. Such strategies should generally be considered only at intersections with a persistent crash pattern that cannot be changed by less expensive methods, such as clearing sight triangles at intersections and in medians.

Examples of different types of realignment are shown in figure 73.

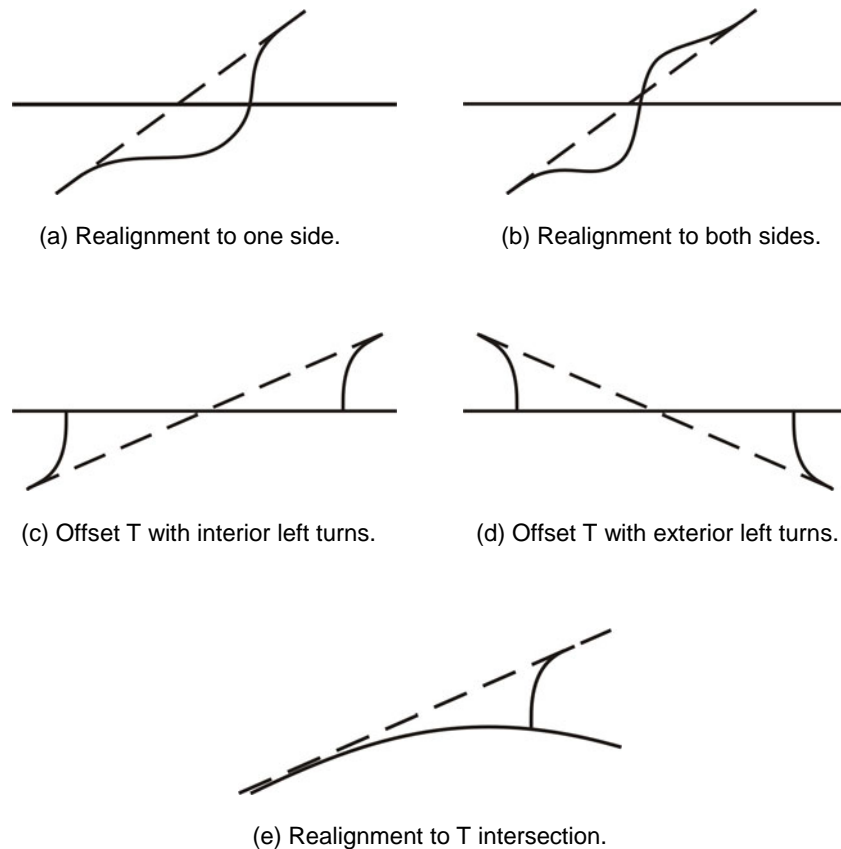


Figure 73. Diagrams of different types of intersection realignment.^(3, Exhibit 9-18)

Applicability

Realignment of the approaches on an intersection may be applicable where severe collision problems occur.

Safety Performance

At skewed intersections, crossing distances are lengthened and the conflict area within the intersection is greater. This increases the potential for collisions.

Roads that intersect with each other at angles less than 90 degrees can present sight-distance and operational problems for drivers. A high incidence of right-angle accidents, particularly involving vehicles approaching from the acute angle, may be the result of a problem associated with skew. Because vehicles have a longer distance to travel through the intersection (increasing their exposure to conflicts), drivers may find it difficult to look to the left at an approach on an acute angle, and vehicles turning right at an acute angle may encroach on vehicles approaching from the opposite direction. When right turns on red are permitted, drivers may have more difficulty judging gaps when turning. Also, crossing distances for pedestrians are increased.

Skewed intersections, in addition to potentially having intersection sight-distance problems, could also present a different sight obstruction for drivers. It is possible that the vehicle body itself could block a driver's view of the cross road, depending on the angle of the skew, the position of the vehicle on the roadway, and the position of the driver in the vehicle.⁽⁴³⁾

Skewed intersections pose particular problems for older drivers, many of whom experience a decline in head and neck mobility. A restricted range of motion reduces older drivers' ability to

effectively scan to the rear and sides of the vehicle to observe blind spots. They may also have trouble identifying gaps in traffic when making a left turn, or safely merging with traffic when making a right turn.⁽¹²⁾

No specific references to safety benefits of removing intersection skew were found.

If utility poles and/or illumination running alongside the road remain in the same location after alignment, they may create a visual illusion that the road is still in its old alignment. A low-cost solution is to provide delineation on the curves at the beginning of the realignment, but some collisions may still occur.

Operational Performance

Any improvement to intersection skew will improve operations involving turning vehicles. In addition, improvement to intersection skew often reduces vehicle and pedestrian clearance time, which may result in an overall reduction in delay to all users. Because such projects are significant undertakings, the number of through and turning lanes and signal phasing should be reevaluated; this may result in a significant improvement in intersection operations.

Multimodal Impacts

As highly skewed intersections mean longer crossing distances for pedestrians, any improvement in skew angle will reduce pedestrian exposure to traffic and likely improve pedestrian safety.

Longer commercial vehicles will have considerable difficulty turning at an intersection where adjacent legs meet at an angle at less than 60 degrees. Considerable off-tracking will occur. Any improvement to skew angle will particularly improve the safety and operation when these vehicles attempt such turns.

Physical Impacts

Traffic signals, controllers, signage, and illumination may all have to be relocated if this treatment is undertaken.

Socioeconomic Impacts

Removing intersection skew may involve acquisition of adjacent land, removal of structures, and relocation of road furniture. If this is the case, this improvement may be costly.

Summary

Table 63 summarizes the issues associated with removing intersection skew.

Table 63. Summary of issues for removing intersection skew.

Characteristic	Potential Benefits	Potential Liabilities
Safety	Reduce left-turn/oncoming collisions. Reduce right-turn-on-red collisions.	Possible increase in run-off-road collisions
Operations	Improve turning operations. Reduce vehicle and pedestrian clearance time.	None identified.
Multimodal	Reduce crossing distance for pedestrians. Improve alignment for pedestrian accessibility.	None identified.
Physical	None identified.	Relocation of all signal equipment, signage and other street furniture.
Socioeconomic	None identified.	Will be expensive to implement. Adjacent property issues. Relocation of street furniture.
Enforcement, Education, and Maintenance	None identified.	None identified.

10.1.2 Remove Deflection in Travel Path for Through Vehicles

Intersections with substantial deflections between approach alignments can produce operational and safety problems for through vehicles as they navigate through an intersection. Forced path changes for through vehicles violate driver expectations and may pose problems for unfamiliar drivers. Violation of driver expectancy can result in reduced speeds through the intersection. Crashes influenced by a deflection in travel path are likely to include rear-end, sideswipe, head-on, and left-turning/through crashes. Acceptable deflection angles through intersections vary by individual agency, but are typically related to the design and/or posted speed on an intersection approach. Typical maximum deflection angles are 3 to 5 degrees. An example of deflection in through-vehicle travel paths is shown in figure 74.

Applicability

Removing deflection in the through vehicle travel path is applicable as a treatment where:

- Deflection angles exceed 3 to 5 degrees.
- Conflicts result from driver confusion in proceeding through the intersection or turning left.
- A high number of rear-end, sideswipe, head-on, and left-turning/through collisions occur on the affected approaches.

Safety Performance

Redesign of an intersection approach (or approaches) to eliminate deflection in the through vehicle travel path should eliminate crashes related to the situation. Proper design of an intersection should provide traffic lanes that are clearly visible to drivers at all times, clearly understandable for any desired direction of travel, free from the potential for conflicts to appear suddenly, and consistent in design with the portions of the highway approaching the intersection. The sight distance should be equal to or greater than minimum values for specific interchange conditions.



Photograph Credit: Lee Rodegerdts, 2003

Figure 74. Example of deflection in travel paths for through vehicles.

Operations

Eliminating deflection for through vehicles will improve traffic flow, although the amount of improvement may be difficult to quantify. No existing analytical or simulation models are sensitive to deflection of through vehicles.

Multimodal Impacts

Redesign of an intersection approach or approaches will particularly benefit heavy vehicles and buses by reducing the amount of off-tracking as they proceed through the intersection.

Physical Impacts

Additional right-of-way may be required to realign through lanes.

Socioeconomic Impacts

Eliminating deflection should be done for a low to moderate cost. Impacts may be largely confined to one side of the intersection.

Summary

Table 64 summarizes the issues associated with the removal of vehicle path deflection.

Table 64. Summary of issues for removing deflection of vehicle path.

Characteristic	Potential Benefits	Potential Liabilities
Safety	Decrease in all collision types.	None identified.
Operations	Improvement in traffic flow.	None identified.
Multimodal	Heavy trucks/transit.	None identified.
Physical	None identified.	Additional right-of-way may be required.
Socioeconomic	None identified.	Low to moderate costs.
Enforcement, Education, and Maintenance	None identified.	None identified.

10.1.3 Convert Four-Leg Intersection to Two T-Intersections

For some signalized four-leg intersections with very low through volumes on the cross street, the best method of improving safety may be to convert the intersection to two T-intersections. This conversion to two T-intersections can be accomplished by realigning the two cross-street approaches an appreciable distance along the major road, thus creating separate intersections that operate relatively independently of one another.

Applicability

This improvement may be applicable to signalized four-leg intersections with very low through volumes on the cross street, yet having a relatively high number of unusually severe collisions.

Safety Performance

In a study conducted by Hanna et al., offset intersections had collision rates that were approximately 43 percent of the accident rate at comparable four-leg intersections.⁽¹³⁹⁾ This study did not differentiate between signalized and nonsignalized intersections.

Table 65 shows the number of merging, diverging and crossing (left-turn and angle) conflicts for two closely spaced T-intersections as compared to a four-leg signalized intersection. Compared to a four-leg signalized intersection, two closely spaced T-intersections have less merge/diverge and left-turn crossing conflict points and no angle crossing conflict points. Figure 75 shows the conflict point diagram for two closely spaced T-intersections.

Table 65. Number of conflict points at a four-leg signalized intersection compared to two closely spaced T-intersections.

Conflict Type	Four-Leg Signalized Intersection	Two Closely Spaced T-Intersections
Merging/diverging	16	12
Crossing (left turn)	12	6
Crossing (angle)	4	0
Total	32	18

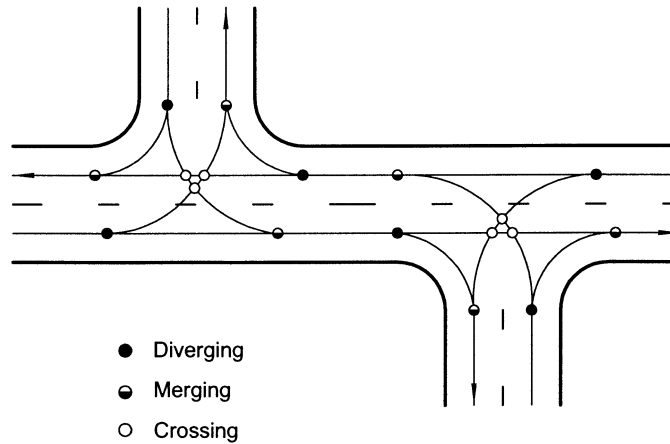


Figure 75. Conflict point diagram for two closely spaced T-intersections

Table 66 summarizes the expert opinion of the authors with regard to the safety benefits of a conversion of a four-leg signalized intersection to two T-intersections.

Table 66. Safety benefits of converting a four-leg signalized intersection to two T-intersections: Expert opinion.

Treatment	Surrogate	Implication
Convert four-leg intersection to two T-intersections	Conflict points	Estimated minor decrease in merging/diverging collisions Estimated significant decrease in left turn collisions Estimated major decrease in angle collisions

Operational Performance

If through volumes on the minor street are high, the intersection may be safer if left as a conventional four-leg intersection. Converting it to two T-intersections would only create excessive turning movements at each of the T-intersections.

Another potential difficulty with this strategy is the spacing between the two T-intersections. If they are not spaced far enough apart, two problems can occur. First, there may not be enough storage length for the left-turning vehicles between the two intersections if left-turn movements overlap (negative offset). Second, the operation of the two intersections may interfere with one another. In general, the offset T-intersection arrangement where major street left turns do not overlap (positive offset) is better because it eliminates the problem of queue overlap for the major street left turns.

Another difficulty may occur in providing safe access to the properties adjacent to the former four-leg intersection. Driveway access should be considered during the design process.

Multimodal Impacts

No significant multimodal impacts are expected. The smaller T-intersections may have shorter pedestrian clearance times and shorter cycle lengths, resulting in shorter overall delay for pedestrians and cyclists.

Physical Impacts

The intersections should be separated enough to ensure the provision of adequate turn-lane channelization on the major road.

Relocation of traffic signals, signage, and other street furniture would be required.

This treatment would involve purchasing an additional set of traffic signals.

Socioeconomic Impacts

Significant costs would be associated with this improvement.

Enforcement, Education, and Maintenance

Due to the change in traffic patterns necessitated by this treatment, public acceptance and understanding of the issues and reasons for converting the intersection will be an important consideration.

Summary

Table 67 summarizes the issues associated with the conversion of a four-leg intersection to two T-intersections.

Table 67. Summary of issues for converting a four-leg intersection to two T-intersections.

Characteristic	Potential Benefits	Potential Liabilities
Safety	Angle collisions. Left-turn collisions.	None identified.
Operations	None identified.	Operations of each intersection may interfere with each other if spacing is insufficient.
Multimodal	May have shorter delay at each intersection.	None identified.
Physical	None identified.	Relocation of traffic signal, signage, street furniture. Additional set of traffic signals required.
Socioeconomic	None identified.	Significant costs.
Enforcement, Education, and Maintenance	None identified.	Education may be needed on the issues and reasons for conversion.

10.1.4 Convert Two T-Intersections to Four-Leg Intersection

For some signalized offset T-intersections with very high through volumes on the cross street, the best method for improving safety may be to convert the intersection to a single four-leg intersection. This can be accomplished by realigning the two cross-street approaches to meet at a single point along the major road.

Applicability

This improvement may be considered for signalized offset T-intersections with very high through volumes on the cross street and a high frequency of collisions associated with turning movements involving traffic on the cross street.

Safety Performance

In the previous section, it was suggested that converting a four-leg intersection to two T-intersections would lead to an improvement in safety using conflict points as a surrogate. However, in some circumstances, two T-intersections may be experiencing safety problems due to the conditions described above that could be addressed through a conversion to a four-leg intersection. It is expected that this strategy would reduce collisions involving left-turning traffic from the major road onto the cross street at each of the two T-intersections. It can reduce or eliminate safety problems associated with insufficient spacing between existing offset T-intersections.

Operational Performance

The success of this strategy depends on the through volume of the cross street. If through volumes are low, the intersection may be safer if left as two offset T-intersections. Two offset T-intersections with low through volumes on the cross street are generally safer than a four-leg intersection.

Multimodal Impacts

No significant multimodal impacts are expected. The larger single intersection may have longer pedestrian clearance times and longer cycle lengths, resulting in longer overall delay for pedestrians and cyclists.

Physical Impacts

Relocation of traffic signals, signage, and other street furniture would be required.

This treatment would involve the removal of one set of traffic signals.

Socioeconomic Impacts

Significant costs would be associated with this improvement.

Enforcement, Education, and Maintenance

Due to the change in traffic patterns involved in carrying out this treatment, public acceptance and understanding of the issues and reasons for converting the intersection will be an important consideration.

Summary

Table 68 summarizes the issues associated with the conversion of two T-intersections to a four-leg intersection.

Table 68. Summary of issues for converting two T-intersections to one four-leg intersection.

Characteristic	Potential Benefits	Potential Liabilities
Safety	Left-turn/rear-end collisions.	Angle collisions.
Operations	Improved operations for through traffic.	None identified.
Multimodal	None identified.	May have longer delay.
Physical	None identified.	Relocation of traffic signal, signage, street furniture. Removal of a set of traffic signals required.
Socioeconomic	None identified.	Significant costs.
Enforcement, Education, and Maintenance	None identified.	Education may be needed on the issues and reasons for conversion.

10.1.5 Close Intersection Leg

For some signalized intersections with severe crash histories, the best way to improve safety may be to close a leg or convert one leg to a one-way movement away from the intersection. Closing a leg should generally be considered only when less restrictive measures have been tried and have failed. Closing a leg can be accomplished by closing and abandoning a minor approach using channelizing devices or by reconstructing the minor approach so it ends before reaching the intersection with the major street. Though it is a significant modification to an intersection, it can be

a low-cost treatment. This treatment may be most applicable to intersections with more than four legs.

Applicability

This treatment may be considered in situations where other treatments with fewer impacts have failed. Possible applications are in situations where a high and unusually severe number of collisions are occurring that involve movements to and from the leg in question.

Safety Performance

Closing a leg should eliminate crashes related to that leg. Consideration must be given to the adjacent intersections and to alternative routes onto which traffic would be diverted, and the potential impact to safety on those routes. Estimates of safety benefits are shown in table 69.

Table 69. Safety benefits associated with street closures: Selected findings.

Treatment	Implication
Street closure—cross intersection ⁽¹³⁷⁾	50% estimated reduction in adjacent approach collisions. 50% estimated reduction in opposing turn collisions. 50% estimated reduction in pedestrian collisions. 100% estimated reduction in loss-of-control collisions.
Street closure—close stem of T-intersection ⁽¹⁴⁰⁾	100% estimated reduction in adjacent approach collisions . 100% estimated reduction in opposing turn collisions. 50% estimated reduction in pedestrian collisions. 100% estimated reduction in loss-of-control collisions.

Operational Performance

Closing a leg will mean simplifying the signal phasing and may mean a shorter cycle. However, closing a leg will considerably alter traffic patterns in the area if volumes on the leg to be closed are significant. The capacity of surrounding roads and intersections to accommodate the diverted traffic will need to be considered.

Transit operations may be significantly impacted if routes use the leg being closed.

Physical Impacts

In closing a leg, a barrier will need to be constructed. This barrier should be aesthetically pleasing, even if temporary. Landscaping should be considered after it is determined that this closure will be permanent.

Multimodal Impacts

It may be possible to maintain pedestrian and bicycle connections to the closed leg, thus maintaining existing circulation patterns. If such connections can be maintained, the closure may help to promote a more pedestrian-friendly environment.

Socioeconomic Impacts

Due to the significant change in traffic patterns involved, public acceptance and understanding of the issues and reasons for converting the intersection are critical (particularly for residents or businesses on the closed leg).

Enforcement, Education, and Maintenance

Such a treatment would need agreement from all emergency services, as emergency response could be significantly affected.

Summary

Table 70 summarizes the issues associated with closing an intersection approach leg.

Table 70. Summary of issues for closing an intersection approach leg.

Characteristic	Potential Benefits	Potential Liabilities
Safety	Eliminates all collisions involving movements on affected approach.	Collision migration to another location.
Operations	Shorter cycle length.	Alternation of traffic patterns; increased congestion elsewhere.
Multimodal	Bike lanes/sidewalks can remain for accessing closed street; may create pedestrian-friendly environment.	None identified.
Physical	A landscaped barrier will improve aesthetics.	Barrier required.
Socioeconomic	None identified.	Buy-in from emergency services required.
Enforcement, Education, and Maintenance	None identified.	None identified.

10.2 INDIRECT LEFT-TURN TREATMENTS

Indirect left turns can improve the safety and operations of high-volume intersections. These designs remove the left-turning vehicles from the traffic stream without causing them to slow down or stop in a through-traffic lane, thereby reducing the potential for delay and rear-end crashes. Right-angle crashes are also likely to decrease after indirect left-turn treatments are implemented. Such treatments are effective on divided highways with medians too narrow to accommodate left-turn lanes with sufficient storage capacity. An overview of these types of intersection forms can be found in several sources.^(141,142,143)

In some cases, it is possible to implement indirect left turns using appropriate signing. Implementation costs and time could be quite high, however, if right-of-way needs to be acquired to construct indirect left turns. Care should be taken to ensure that safety problems are not transferred to nearby intersections if drivers choose alternative routes. Clear signing is a necessity for indirect left-turn designs, especially if there are not similar treatments at other intersections in an area.

10.2.1 Jughandle

As defined in the New Jersey Department of Transportation (NJDOT) design manual, a jughandle is “an at-grade ramp provided at or between intersections to permit the motorists to make indirect left turns and/or U-turns.”⁽¹⁴⁴⁾ The NJDOT has used jughandles for years to minimize left-turn conflicts at intersections. Other States that have implemented jughandles to a lesser degree include Connecticut, Delaware, Oregon, and Pennsylvania.

Jughandles are one-way roadways in two quadrants of the intersection that allow for removal of left-turning traffic from the through stream without providing left-turn lanes. All turns—right, left, and U-turns—are made from the right side of the roadway. Drivers wishing to turn left exit the major roadway at a ramp on the right and turn left onto the minor road at a terminus separated from the main intersection. Less right-of-way is needed along the roadway because left-turn lanes are unnecessary. However, more right-of-way is needed at the intersection to accommodate the jughandles.

Figure 76 illustrates a jughandle intersection with the ramps located in advance of the intersection. The various possible movements are illustrated in figure 77. As can be seen, vehicles on the major street use the ramp to make turning movements at the intersection. Examples are shown in figures 78 and 79.

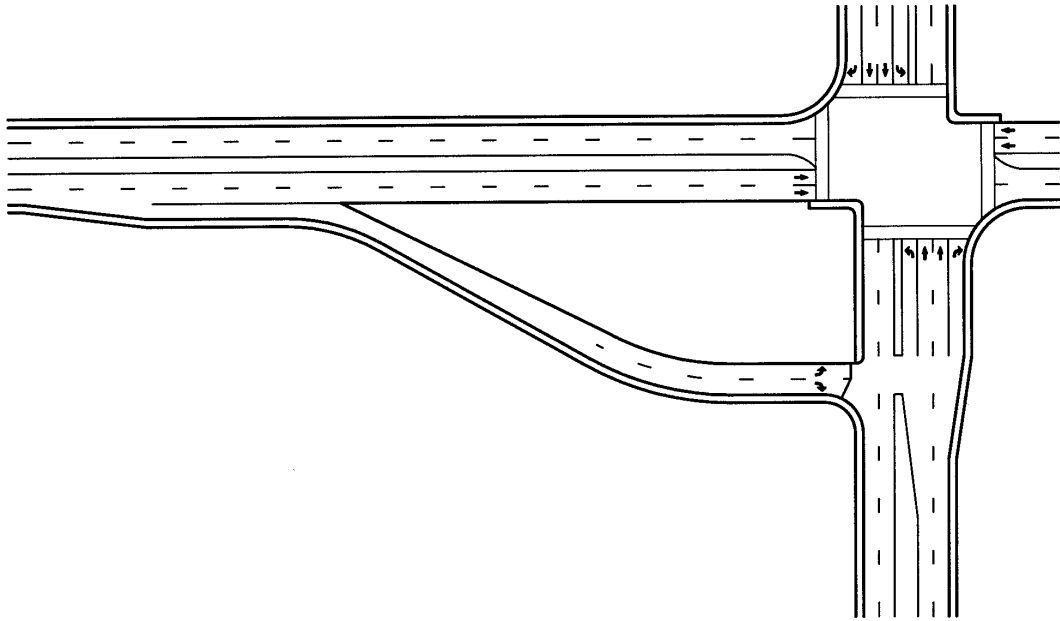


Figure 76. Diagram of a jughandle intersection. (adapted from 145)

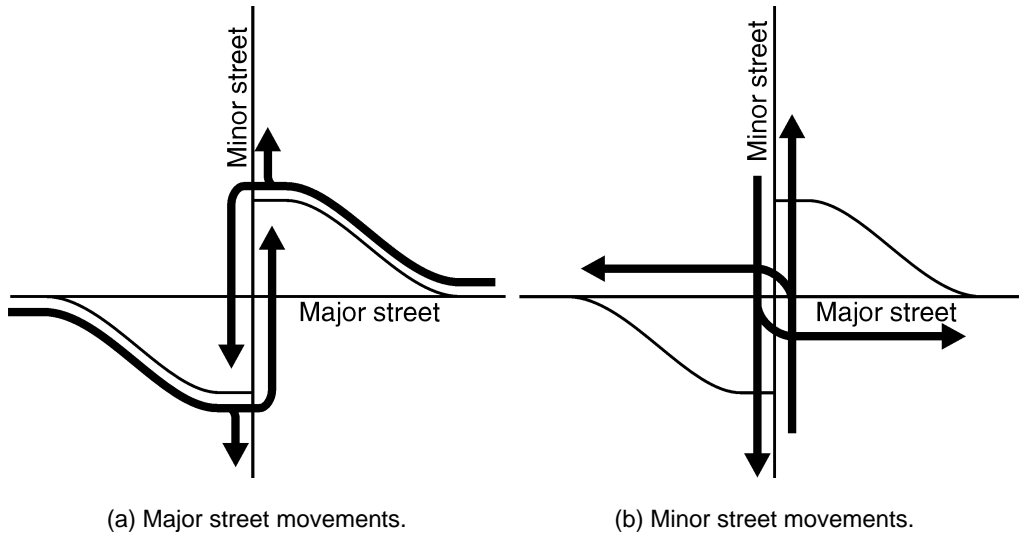


Figure 77. Vehicular movements at a jughandle intersection.



Figure 78. Example of a jughandle intersection.



Figure 79. Another example of a jughandle intersection.

Applicability

Jughandles may be appropriate at intersections with high major street through movements, low-to-medium left turns from the major street, low-to-medium left turns from the minor street, and any amount of minor street through volumes.⁽¹⁴¹⁾ Intersections too small to allow large vehicles to turn left, as well as intersections with medians too narrow to provide a left-turn lane, may also be appropriate locations for jughandles.

Jughandles address safety deficiencies involving left-turn collisions and operational deficiencies due to the lack of available green time for major-street through movements.

Design Features

The NJDOT design manual provides design guidelines for jughandles.⁽¹⁴⁴⁾ Jughandles commonly are constructed in advance of the intersection (see figure 80). If left-turn movements onto the cross street are problematic, a loop ramp may be constructed beyond the intersection to allow these vehicles to make a right turn onto the cross street, as shown in figure 81. The disadvantage is that additional right-of-way is needed to accommodate the loop ramp and the travel distance is greater. Note that although the cited guidelines do not show pedestrian or bicycle facilities, these should be included in as appropriate.

Key features from the design manual are summarized below:

- Deceleration lane = length should be determined based on speed of mainline and speed of exit curve.
- Desirable exit curve = 75 to 90 m (250 to 300 ft) radius.
- Ramp length = sufficient to accommodate vehicle storage.
- Number of lanes = one or two lanes.
- Lane width = the minimum width for a one-lane ramp should not be less than 6.6 m (22 ft).
- Ramp design speed = 25 to 40 km/h (15 to 25 mph).
- Ramp location = should be located a sufficient distance from the adjacent signalized intersection to avoid queue spill back from the signal.
- Access = No access should be permitted to the ramp.
- Right-turn radius at cross street = A minimum radius of 10.5 m (35 ft) should be used from the right-turn movement from the ramp to the cross street. This movement should be channelized.

Signing at jughandle intersections is critical, as drivers need to be given an indication that they must exit to the right to make a left turn. Figure 82 gives an example of signing used in New Jersey. Because jughandles are relatively common in New Jersey, the signing employed is perhaps more minimal than might be considered in other areas where jughandles are more novel.

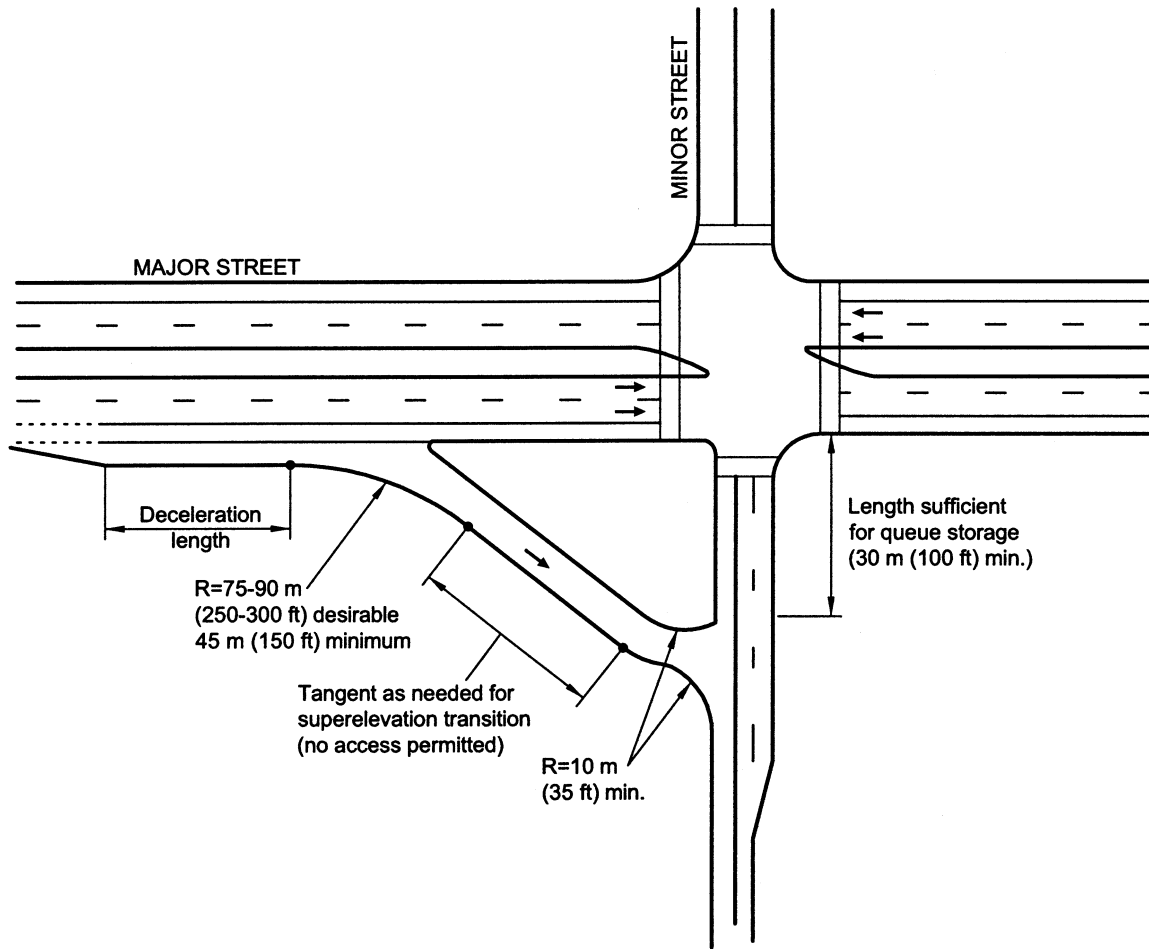


Figure 80. Design layout of near-side jughandle. (adapted from 144)

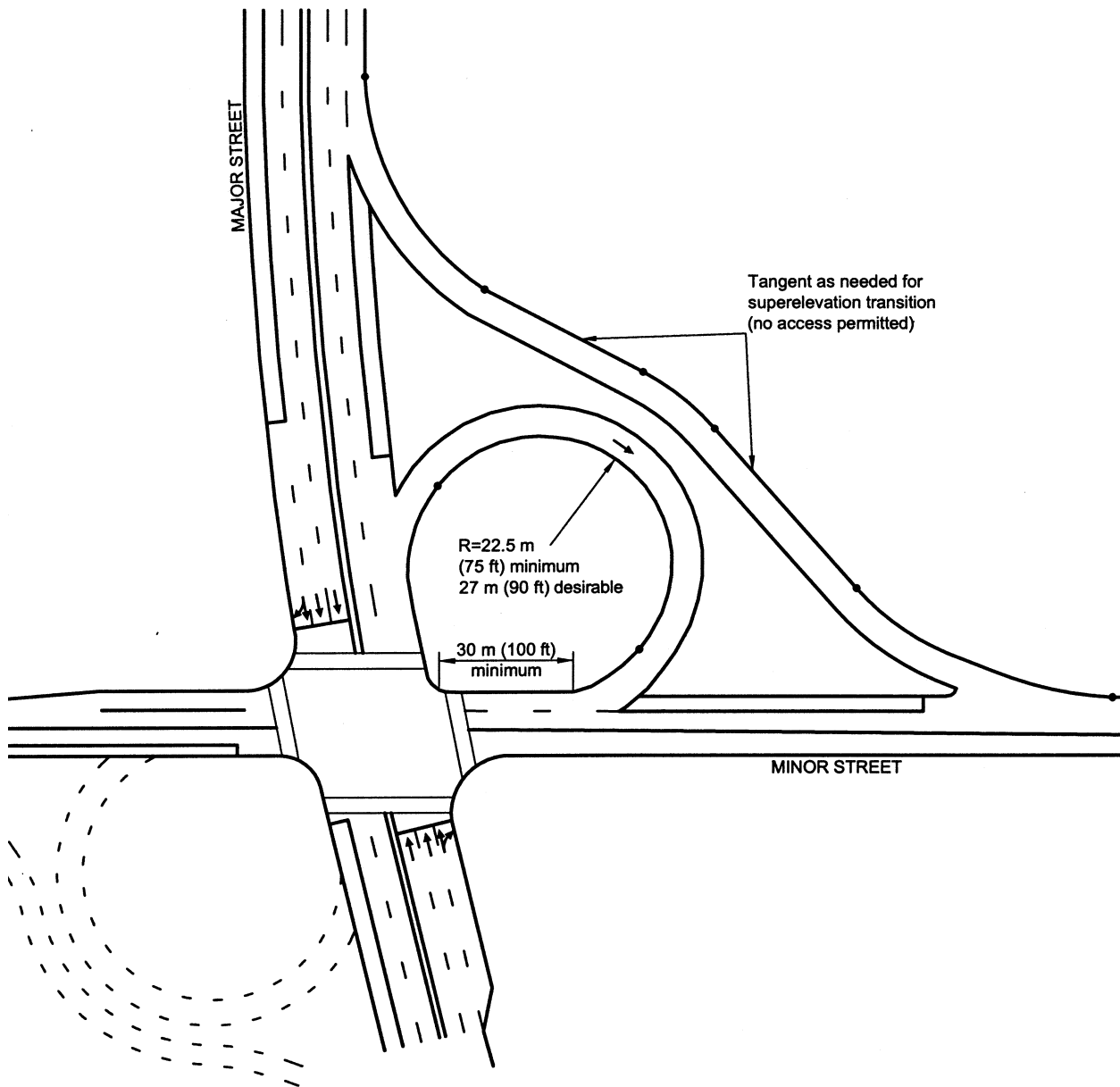


Figure 81. Design layout of far-side jughandle. (adapted from 144)



Photograph Credit and Copyright: Arthur Eisdorfer, 2002.

Figure 82. Example of jughandle and associated signing.

Operational Features

The jughandle should operate with stop control at the minor street approach. Right turns onto the cross street may operate with yield control. Signing is needed in advance of the jughandle ramp to indicate that motorists destined to the left need to exit the roadway from the right-hand lane.

With the removal of left-turn lanes at the signalized intersection location, the signal can be operated with either two or three phases, as shown in figure 83. The third phase would be needed to accommodate minor street left-turn movements. The reduction in phases allows for either shorter cycle times or allocation of green times to the major street through movements. Shorter cycle lengths should be considered to minimize vehicle queues on the cross street.

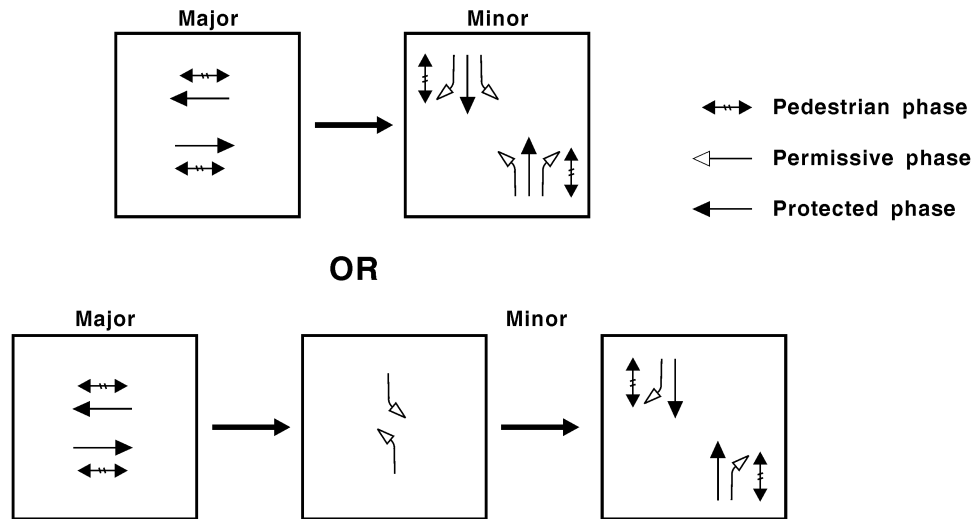


Figure 83. Signal phasing of a jughandle intersection.

Safety Performance

Jughandles remove left-turning vehicles from the through lanes and thus are likely to reduce crashes as long as sufficient signing is provided to help eliminate driver confusion. The NJDOT has constructed many jughandle intersections; these are considered to be safe. No significant increase in crashes has been experienced since the implementation of the jughandles, though a decrease in crashes is not reported, either.⁽¹⁴⁶⁾

Driver confusion may result when jughandles are first constructed in an area. Also, areas with significant numbers of unfamiliar drivers may experience problems related to driver confusion, even after the jughandles are no longer new. Signing should be used to inform drivers how to make turns. A public information campaign leading up to the opening of the new ramp(s) may be appropriate.

Visual cues can reduce the amount of driver confusion. A raised concrete median barrier, installed to separate opposing directions of travel, may lead drivers to expect that turns from the left are not possible, and may explain why the collision experience at New Jersey jughandles has been good.⁽¹⁴⁶⁾

Pedestrians on the cross street will have to cross the ramp terminal, thus increasing their exposure to potential conflict. The main intersection, however, will maintain a minimum width, and crossing distance will not increase (as it would with construction of a left-turn lane).

Table 71 shows the number of conflict points at a four-leg signalized intersection as compared to a four-leg signalized intersection with two jughandles. A four-leg signalized intersection with two jughandles would have fewer crossing (left-turn) conflict points. Figure 84 shows the conflict point diagram for a four-leg signalized intersection with two jughandles.

Table 71. Number of conflict points at a four-leg signalized intersection compared to a four-leg signalized intersection with a jughandle.

Conflict Type	Four-Leg Signalized Intersection	Four-Leg Signalized Intersection with Two Jughandles
Merging/diverging	16	16
Crossing (left turn)	12	6
Crossing (angle)	4	4
Total	32	26

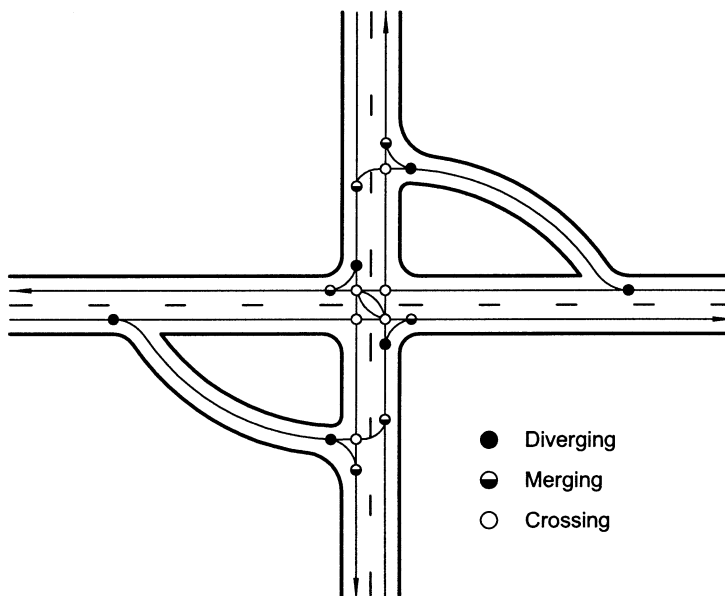


Figure 84. Conflict point diagram for a four-leg signalized intersection with two jughandles.

Table 72 summarizes the expert opinion of the authors with regard to the safety benefits of a conversion of a four-leg signalized intersection to four-leg signalized intersection with two jughandles.

Table 72. Safety benefits of converting a four-leg signalized intersection to a four-leg signalized intersection with two jughandles: Expert opinion.

Treatment	Surrogate	Implication
Convert signalized four-leg intersection to signalized four-leg intersection with two jughandles	Conflict points	Offers the potential for significant decrease in left-turn collisions.

Operational Performance

The operations of a jughandle are best represented through the use of microsimulation models. A microsimulation model reflects the queue interaction between the signalized intersection and the minor street/ramp terminal intersection. An isolated intersection analysis can be used to determine the appropriate phases and signal timing parameters for the signalized intersection.

General findings regarding the operational performance of jughandles are summarized below:

- Simulation studies using a range of intersection configurations (number of through lanes on the major and minor street) and volumes from intersections in Virginia and North Carolina suggest a reduction in overall travel time through the intersection when compared to a conventional intersection: –6 to +51 percent during off-peak conditions, and +4 to +45 percent during peak conditions. The studies also show a large increase in the overall percent of stops when compared to a conventional intersection: +15 to +193 percent during off-peak conditions, and +19 to +108 percent during peak conditions.⁽¹⁴⁵⁾
- Because left-turning vehicles must travel a longer distance through the intersection, jughandle intersections do not allow for better travel times for left turns than conventional intersections with the same conditions. They may lead to longer delay and travel distances than other indirect left-turn alternatives. However, the overall delay for the intersection may be lower than that for a conventional intersection.
- The ramp terminals are typically stop-controlled for left turns. This leads to more stops for left-turning vehicles. If cross-street volumes are high, it is possible that the queue of vehicles on the cross street will block the ramp terminal, increasing delay for vehicles at the terminal waiting to turn left onto the cross street.
- The operations and green time requirements for minor-street through volumes should be evaluated with and without the jughandle to ensure that the benefits realized by the main line through movements are not offset by the impact of additional minor-street through traffic.

Multimodal Impacts

With jughandle ramps in place, left-turn lanes are not needed along the mainline; this may reduce the roadway cross section and reduce the amount of pedestrian crossing distance. The elimination of the major street left-turn phase may enable shorter cycle lengths that reduce the amount of delay for pedestrians.

Bicycle lanes should remain at the outside lane and include dotted lines where right-turning vehicles are required to cross to enter the jughandle. Conflicts are reduced at the intersection given that right turns have already been separated from the through travel lane.

Because of the close proximity of the jughandle ramps to the main intersection, transit stops should be located outside the influence area of the intersection, including the jughandle ramps. This will minimize potential queuing conflicts.

Physical Impacts

The amount of land required for construction of a jughandle ramp depends on the storage and super elevation requirements of the ramp. The NJDOT design manual recommends a minimum of 30 m (100 ft) between the ramp terminal intersection at the cross street and the stop bar for the signalized intersection.⁽¹⁴⁴⁾ Hummer and Reid suggest that each jughandle typically requires a triangle 120 m (400 ft) by 90 m (300 ft).⁽¹⁴¹⁾

The infield area created by the ramp may be used as a drainage basin; however, the water surface should be located outside the clear zone.⁽¹⁴⁴⁾ Additional landscaping maintenance may be required for the infield area.

An option that may have fewer impacts is to implement a virtual jughandle by using an existing grid network to divert traffic around the block rather than permitting left turns at the major street intersection.

Summary

Table 73 summarizes the issues associated with jughandles.

Table 73. Summary of issues for jughandles.

Characteristic	Potential Benefits	Potential Liabilities
Safety	Potential reduction in left-turn collisions.	None identified.
Operations	Potential reduction in overall travel time and stops.	Longer travel time and more stops for left-turning vehicles using the jughandle.
Multimodal	Pedestrian crossing distance may be less due to lack of left-turn lanes on the major street. Pedestrian delay may be reduced due to potentially shorter cycle lengths.	Increased exposure for pedestrians crossing the ramp terminal. Ramp diverges may create higher speed conflicts between bicyclists and motor vehicles. Transit stops may need to be relocated outside the influence area of the intersection.
Physical	None identified.	Additional right-of-way may be required.
Socioeconomic	None identified.	None identified.
Enforcement, Education, and Maintenance	None identified.	Education may be needed unless good visual cues are provided.

10.2.2 Median U-Turn Crossover

Median U-turn crossovers eliminate left turns at intersections and move them to median crossovers beyond the intersection. For median U-turn crossovers located on the major road, drivers turn left off the major road by passing through the intersection, making a U-turn at the crossover, and turning right at the cross road. Drivers wishing to turn left onto the major road from the cross street turn right onto the major road and make a U-turn at the crossover.

Figure 85 illustrates a median U-turn configuration, and figure 86 illustrates some of the vehicle movements at such an intersection.

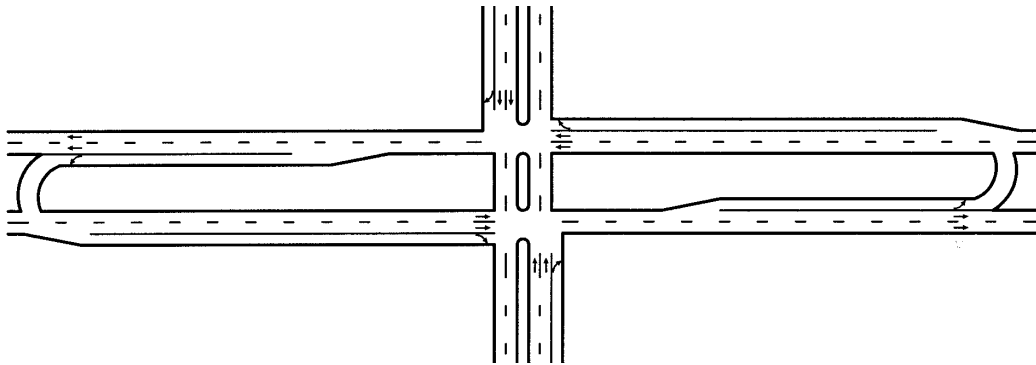


Figure 85. Diagram of a median U-turn crossover from the main line. ^(adapted from 145)

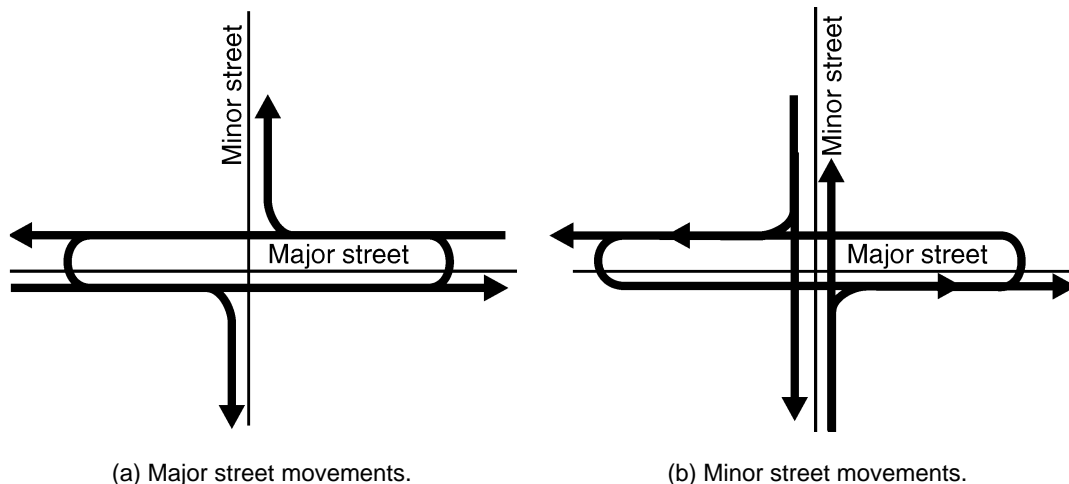


Figure 86. Vehicular movements at a median U-turn intersection.

The median crossover may also be located on the minor road. In this case, drivers wishing to turn left from the major road turn right on the minor road, and left through the median crossover. Minor road vehicles turn left onto the major road by proceeding through the intersection, making a U-turn, and turning right at the major road. Median U-turn crossovers also may be provided on both the major and minor roads at an intersection.

Median U-turn crossovers are very common in Michigan, and drivers are very familiar with them. They have been in use for more than 30 years, and the signing has evolved to become more user friendly.⁽¹⁴¹⁾ Figure 87 shows an example of median U-turn signing used in Michigan.



Photograph Credit: Lee Rodegerdts, 2002

Figure 87. Example of median U-turn signing in Michigan.

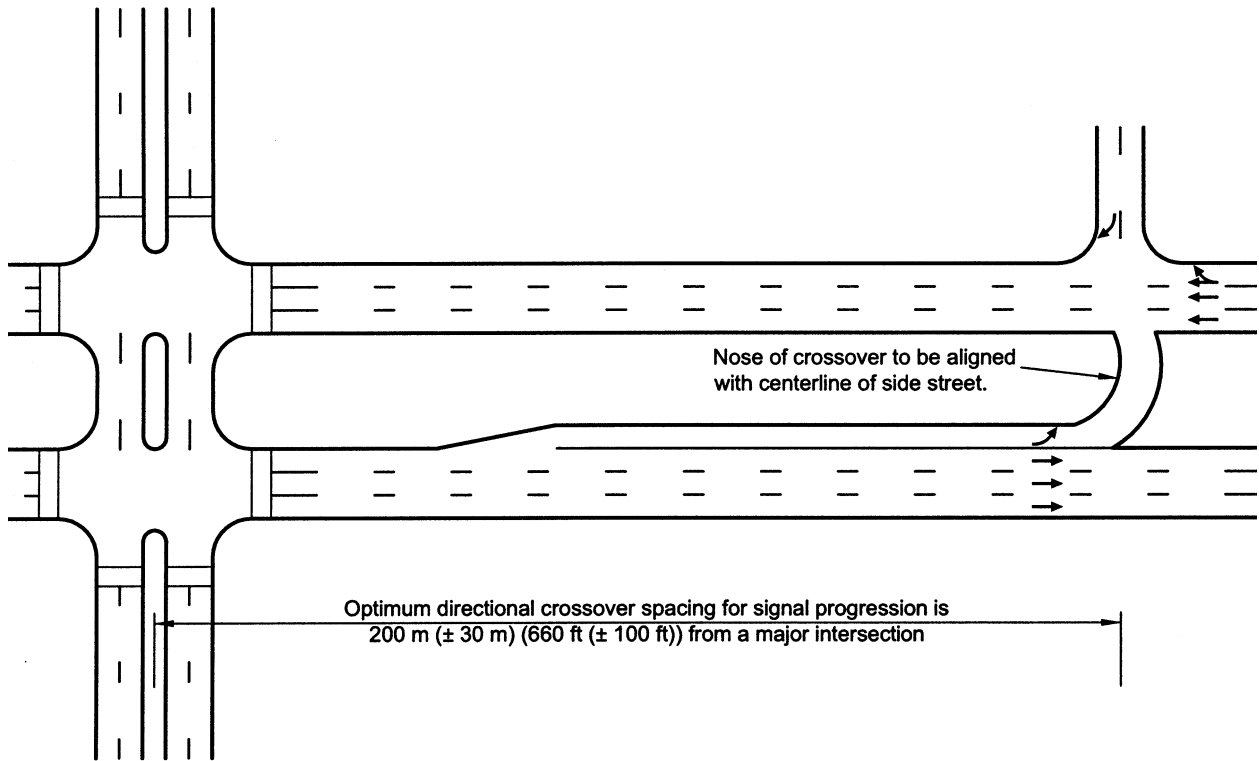
Applicability

Due to the design, median U-turn crossovers require a wide median to enable the U-turn movement. Median U-turns may be appropriate at intersections with high major-street through movements, low-to-medium left turns from the major street, low-to-medium left turns from the minor street, and any amount of minor street through volumes.⁽¹⁴¹⁾ Locations with high left-turning volumes may not be good candidates because the out-of-direction travel incurred and the potential for queue spill back at the median U-turn location could outweigh the benefits associated with removing left-turns from the main intersection.⁽¹⁴¹⁾ Median U-turns can be applied on a single approach.

Design Features

Key design features of median U-turns identified in the literature are summarized below:

- Median U-turn lanes should be designed to accommodate the design vehicle.
- Appropriate deceleration lengths and storage lengths should be provided based on the design volume and anticipated traffic control at the median U-turn.
- The Michigan Department of Transportation advises that the optimum location for the crossover is 170 to 230 m (560 to 760 ft) from the main intersection as shown in figure 88.⁽¹⁴⁷⁾
- To accommodate a semi-trailer combination design vehicle, AASHTO policy recommends that the median on a four-lane arterial should be 18 m (60 ft) wide.⁽³⁾ If design vehicles do not have enough space to turn, additional pavement should be added outside the travel lane to allow these vehicles to complete the maneuver, as shown in figure 89.



The number of crossovers per mile is determined by need. Generally, 200 m (660 ft) spacing is used in urban areas, and 400 m (1320 ft) spacing is used in rural areas.

Figure 88. Diagram of general placement of a median U-turn crossover. (adapted from 147)

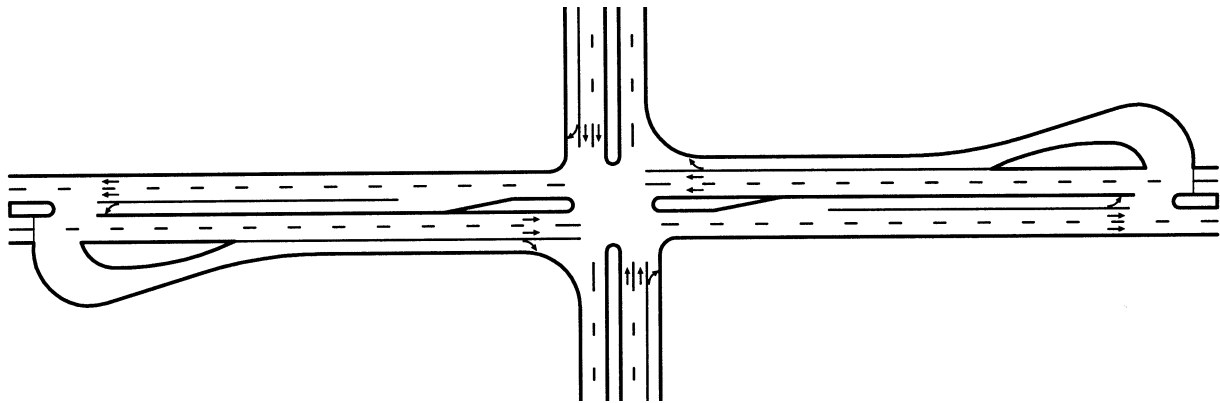


Figure 89. Diagram of a median U-turn crossover from the main line with a narrow median. (adapted from 148)

Operational Features

Key items regarding the operational features of median U-turns are summarized below:

- Median U-turn crossovers allow for two-phase signal operation. This can reduce signal cycle length and delays for through vehicles. Left-turning vehicles have to travel further

to complete the turn, which may offset some operational benefits achieved for through vehicles.

- Signing is needed to alert motorists of the presence of median U-turns and the restriction of left-turn movements at the signalized intersection.
- Installing traffic signals at median U-turn locations requires additional storage for the U-turn movement and requires coordination with adjacent signalized intersections.
- The reduction in phases at the signalized intersection improves the ability to coordinate traffic signals along a corridor.

Safety Performance

According to NCHRP 420, the collision rate along road sections having directional median openings (facilitating U-turn and left turns) versus road sections having full median openings (facilitating all movements) was 49 to 52 percent less for signalized corridors having more than one traffic signal per mile.⁽⁸⁵⁾

Table 74 shows the number of conflict points at a four-leg signalized intersection as compared to a four-leg signalized intersection with a median U-turn crossover. A median U-turn crossover configuration eliminates all crossing (left turn) conflict points. It also reduces the number of merge/diverge conflict points as compared to a four-leg signalized intersection. Figure 90 shows the conflict point diagram for a four-leg signalized intersection with a median U-turn crossover configuration.

Table 74. Number of conflict points at a four-leg signalized intersection compared to a four-leg signalized intersection with a median U-turn crossover configuration.

Conflict Type	Four-Leg Signalized Intersection	Median U-Turn Crossover Configuration
Merging/diverging	16	12
Crossing (left turn)	12	0
Crossing (angle)	4	4
Total	32	16

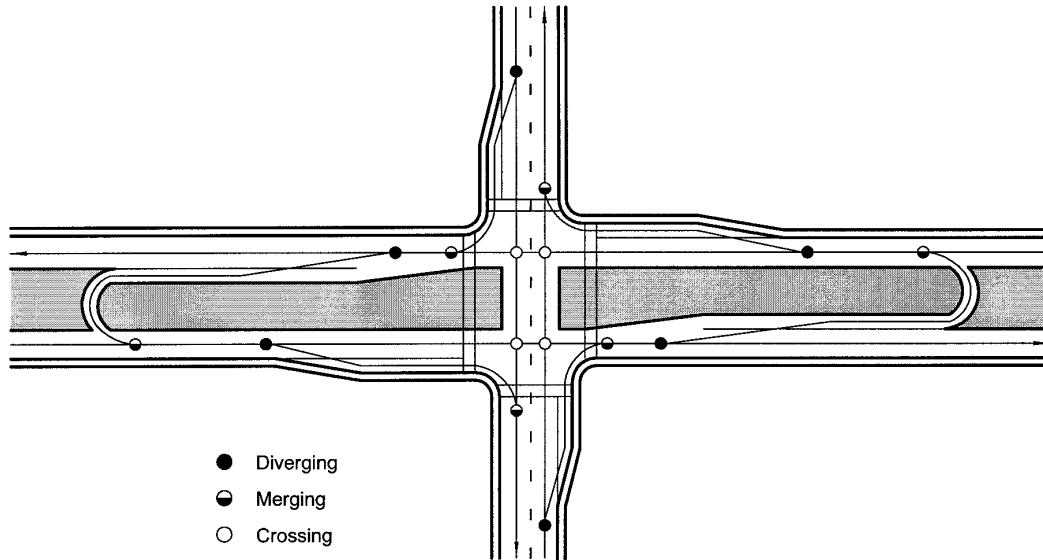


Figure 90. Conflict diagram for a four-leg signalized intersection with median U-turns.

Table 75 summarizes the expert opinion of the authors with regard to the safety benefits of a conversion of a four-leg signalized intersection to a median U-turn crossover configuration.

Table 75. Safety benefits of converting a four-leg signalized intersection to median U-turn crossover configuration: Expert opinion.

Treatment	Surrogate	Implication
Convert signalized four-leg intersection to a median U-turn crossover configuration	Conflict points	Offers the potential for a minor decrease in merging/diverging collisions Offers the potential for a major decrease in left-turn collisions

Operational Performance

Key elements regarding the operational performance of median U-turns are summarized below:

- Median U-turns reduce the number of stops for mainline through movements.⁽¹⁴¹⁾
- The median crossovers can be signalized or unsignalized. Signalized crossovers can be synchronized with the other signals in a corridor to provide progression. If a traffic signal is installed at a median U-turn, the median should be designed to accommodate the maximum design queue to avoid spillover to the main line.
- The operations of a median U-turn should be evaluated using a microsimulation model to determine the effect of progression and queue interaction from the signalized intersection.
- A study on a Michigan corridor used simulation to compare median U-turn crossovers with two-way left-turn lanes (TWLTL). The study showed that during peak hours, the corridor with median U-turn crossovers had a lower travel time by 17 percent and a 25 percent higher average speed than the same corridor with a TWLTL. However, vehicles made more stops on the arterial with median U-turn crossovers. In nonpeak hours, the median U-turn crossovers had the same efficiency as the TWLTL, even though a higher

delay for left-turning vehicles had been expected due to the higher travel distance a vehicle must cover to turn left using a median crossover.⁽¹⁴⁹⁾

- Simulation studies using a range of intersection configurations (number of through lanes on the major and minor street) and volumes from intersections in Virginia and North Carolina suggest a reduction in overall travel time for all movements through the intersection when compared to a conventional intersection: -21 to -2 percent during off-peak conditions, and -21 to +6 percent during peak conditions. The studies also show a general increase in the overall percent of stops when compared to a conventional intersection: -20 to +76 percent during off-peak conditions, and -2 to +30 percent during peak conditions.⁽¹⁴⁵⁾
- Results from a simulation analysis using TRANSYT-7F and CORSIM found that the percentage of stops was reduced for the median U-turn configuration compared with a conventional intersection.⁽¹⁴⁸⁾

Multimodal Impacts

Roadways with median U-turns generally have a greater cross section width resulting in an increased crossing distance for pedestrians. The number of movements that conflict with pedestrians at intersections with upstream/downstream median U-turns is reduced.

Turning paths of the median U-turn should be evaluated to ensure that vehicle paths do not encroach on bike lanes.

Socioeconomic Impacts

Access should be restricted on facilities within the influence of median U-turn locations. Local property owners may oppose such restrictions, particularly if the access already exists.

Education, Enforcement, and Maintenance

Education and enforcement are needed to ensure that vehicles are not making illegal left turns at the main intersection.

Summary

Table 76 summarizes the issues associated with median U-turn crossovers.

Table 76. Summary of issues for median U-turn crossovers.

Characteristic	Potential Benefits	Potential Liabilities
Safety	Potential major reduction in left-turn collisions. Potential minor reduction in merging/diverging collisions.	None identified.
Operations	Potential reduction in overall travel time. Reduction in stops for mainline through movements. Mixed findings with respect to overall stops.	Mixed findings with respect to overall stops.
Multimodal	Number of conflicting movements at intersections is reduced.	Increased crossing distance for pedestrians. Turning paths of the median U-turn may encroach in bike lanes.
Physical	None identified.	May be additional right-of-way needs depending on width of existing median.
Socioeconomic	None identified.	Access may need to be restricted within the influence of the median U-turn locations.
Enforcement, Education, and Maintenance	None identified.	Enforcement and education may be necessary to prevent illegal left turns at the main intersection.

10.2.3 Continuous Flow Intersection

Continuous flow intersections (CFI), both full and partial, have recently been constructed in a small number of locations in the United States. Although too new for a full evaluation of the effect on operations and safety, continuous flow intersections are gaining in popularity. CFI are also sometimes referred to as crossover-displaced left-turn (XDL) intersections.

Description

A CFI removes the conflict between left-turning vehicles and oncoming traffic by introducing a left-turn bay placed to the left of oncoming traffic. Vehicles access the left-turn bay at a midblock signalized intersection on the approach where continuous flow is desired. Figure 91 shows the design of a CFI with crossover displaced left turns, and figure 92 illustrates some of the vehicle movements at such an intersection. As can be seen, the left turns potentially stop three times: once at the midblock signal on approach, once at the main intersection, and once at the midblock signal on departure. However, careful signal coordination can minimize the number of stops. Examples of implemented sites are shown in figures 93 and 94. Note that this section describes an at-grade CFI; a grade-separated version of the CFI was patented (U.S. Patent No. 5,049,000), but the patent expired in 2003.

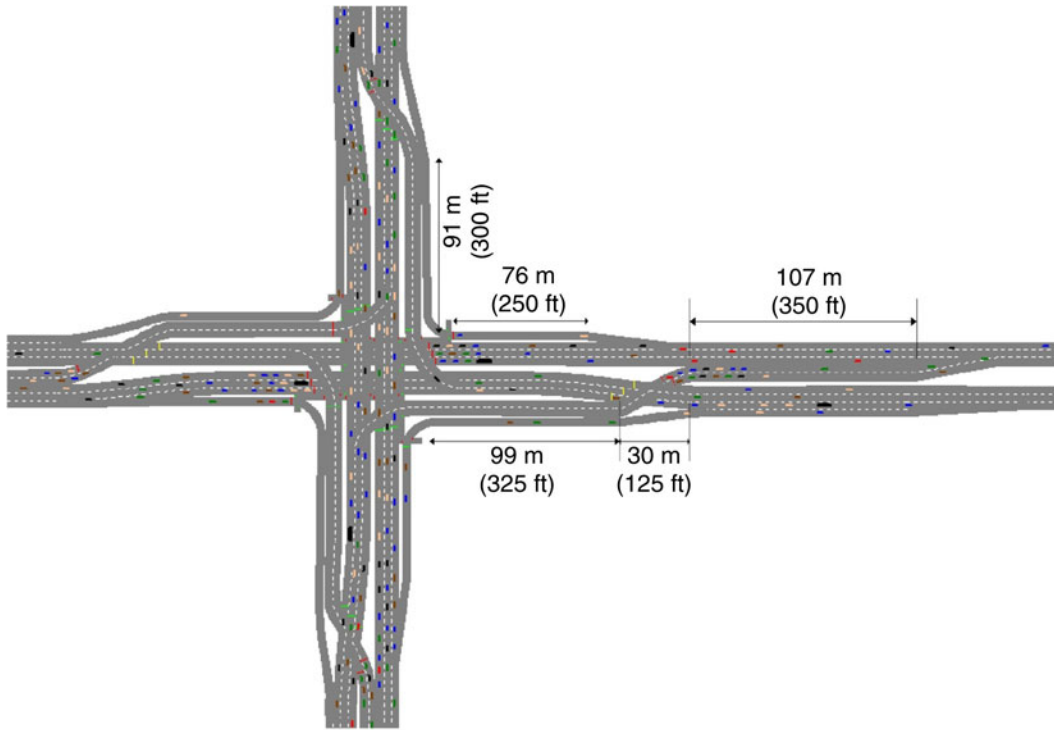


Figure 91. Diagram of a continuous flow intersection.⁽¹⁵⁰⁾

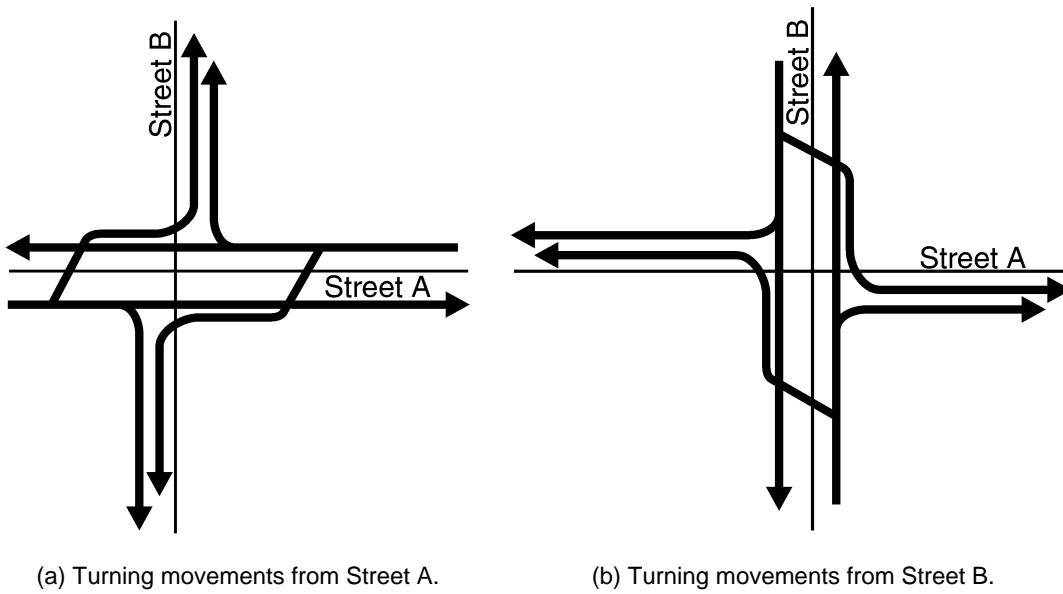


Figure 92. Vehicular movements at a continuous flow intersection.



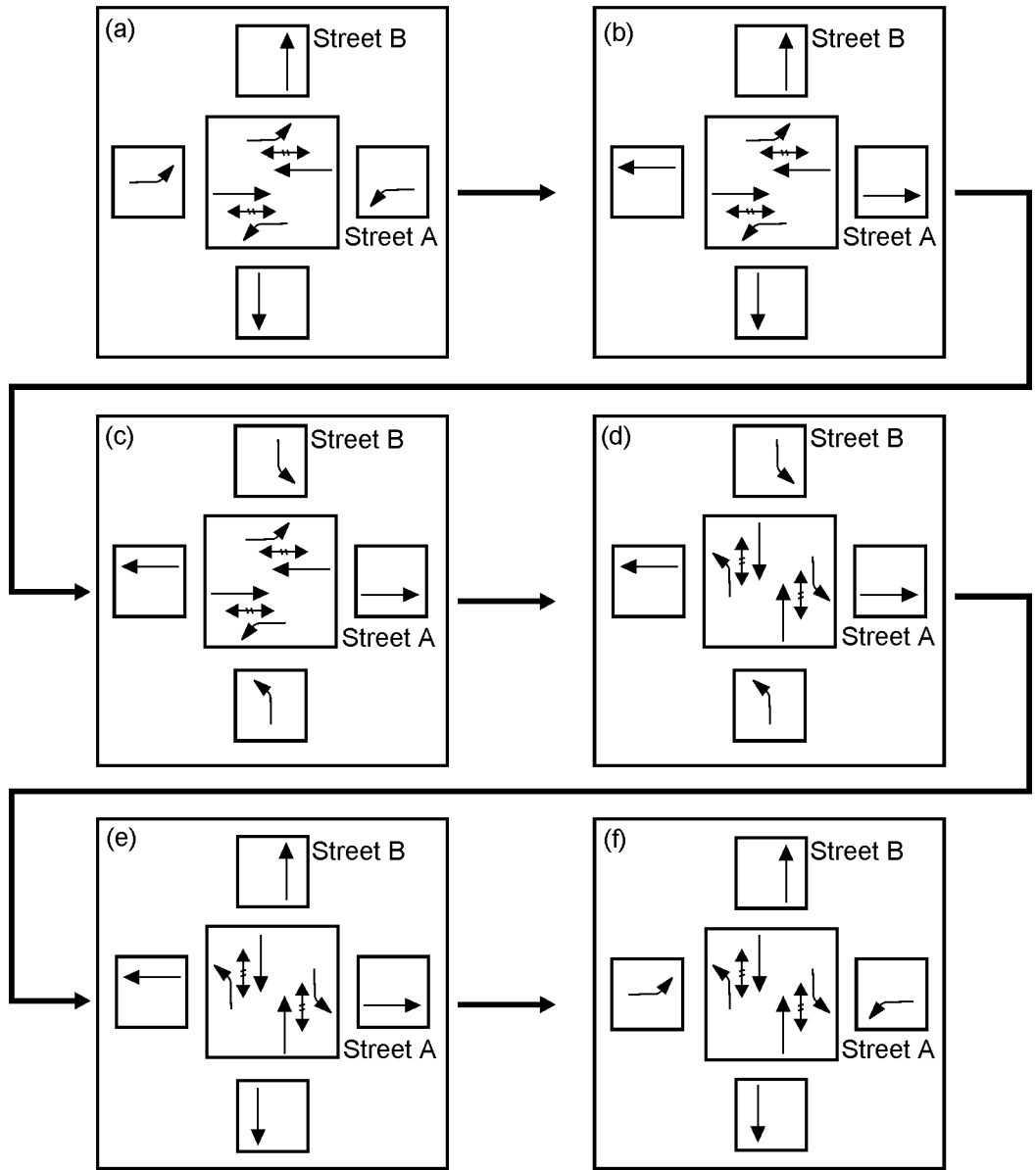
Figure 93. Continuous flow intersection.



Photograph Credit and Copyright: Francisco Mier, 1999

Figure 94. Displaced left turn at a continuous flow intersection.⁽¹⁵¹⁾

The complete CFI design operates as a set of two-phase signals. As part of the first phase, traffic is permitted to enter the left-turn bay by crossing the oncoming traffic lanes during the signal phase serving cross-street traffic. The second signal phase, which serves through traffic, also serves the protected left-turn movements. Figure 95 shows the signal phase sequence used at a CFI.



- a. Street A movements at the major intersection, left turns on the advance intersections on Street A, and through movements on the advance intersections on Street B.
- b. Street A movements at the major intersection and through movements at all advance intersections.
- c. Street A movements at the major intersection, through movements on the advance intersections on Street A, and left turns on the advance intersections on Street B.
- d. Street B movements at the major intersection, left turns on the advance intersections on Street B, and through movements on the advance intersections on Street A.
- e. Street B movements at the major intersection and through movements at all upstream intersections.
- f. Street B movements at the major intersection, through movements on the advance intersections on Street B, and left turns on the advance intersections on Street A.

Figure 95. Signal phasing of a continuous flow intersection. (adapted from 150)

Intersections with high through and left-turn volumes may be appropriate sites for continuous flow intersections. There should be a low U-turn demand because U-turns are restricted with this design. Right-of-way adjacent to the intersection is needed for the left-turn ramps.

Left-turning vehicles make more stops than at conventional intersections, and may experience a slightly higher delay. Through traffic benefits greatly from this design.

Safety Performance

Safety improvements may be experienced by the left-turn movement due to the relocation of the turn lane; rear-end crashes with through vehicles may be reduced. Congestion-related collisions (mainly rear ends) may also decrease if stop-and-go conditions occur less often.

Table 77 shows the number of conflict points at a four-leg signalized intersection as compared to a continuous flow intersection. The number of merging/diverging conflict points is the same at a continuous flow intersection as compared to a conventional four-leg signalized intersection. All left-turn (crossing) conflicts are removed. However, the number of angle (crossing) conflicts would triple. Figure 96 shows the conflict point diagram for a continuous flow intersection.

Table 77. Number of conflict points at a four-leg signalized intersection compared to a continuous flow intersection with displaced left turns on the major street only.

Conflict Type	Four-Leg Signalized Intersection	Continuous Flow Intersection
Merging/diverging	16	14
Crossing (left turn)	12	6
Crossing (angle)	4	10
Total	32	30

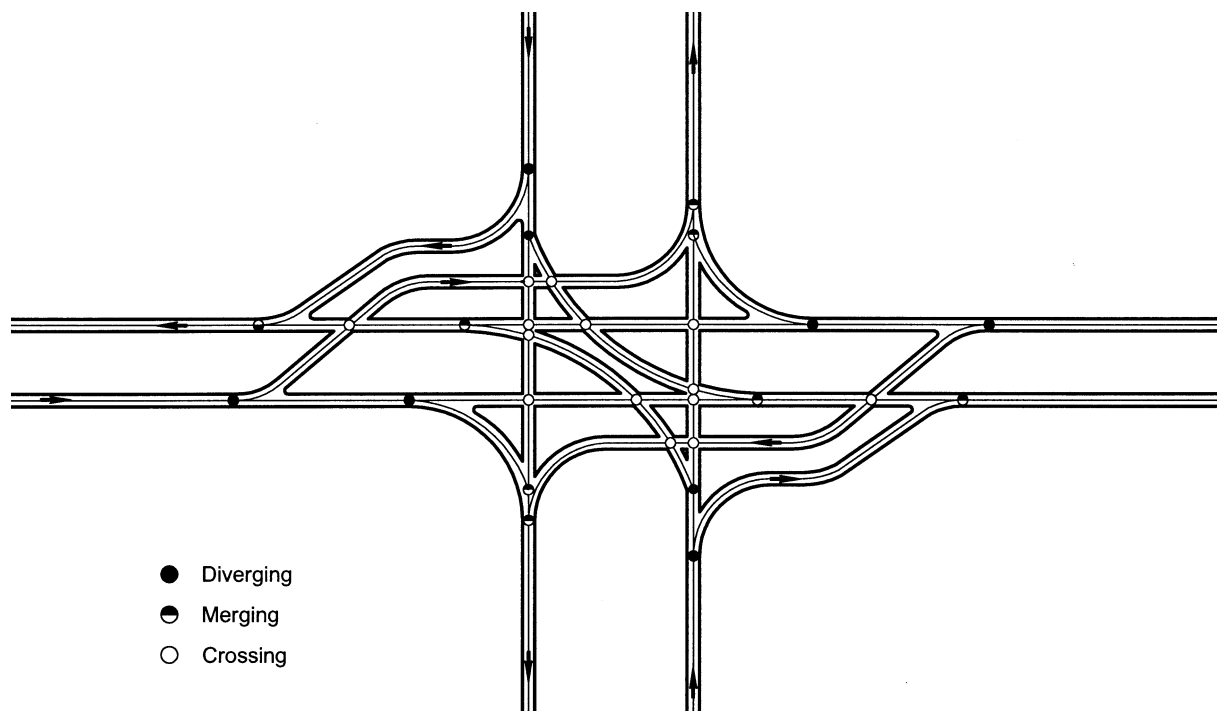


Figure 96. Conflict diagram for a continuous flow intersection with displaced left turns on the major street only.

Table 78 summarizes the expert opinion of the authors with regard to the safety benefits of changing a four-leg signalized intersection to a CFI.

Table 78. Safety benefits of converting a four-leg signalized intersection to a CFI: Expert opinion.

Treatment	Surrogate	Finding
Convert signalized four-leg intersection to continuous flow intersection	Conflict points	Offers the potential for a major reduction in left-turn collisions Offers the potential for a major increase in angle collisions

Operational Performance

The key operational benefit of this intersection is that multiphase signal operation is not required to provide protected left-turn movements. This benefits through traffic. Continuous flow intersections provide an at-grade intersection solution that can improve traffic operations beyond the capabilities of other conventional at-grade solutions.⁽¹⁵²⁾

Jagannathan and Bared evaluated three different CFI configurations (four-leg intersection with displaced left on all approaches; four-leg intersection with displaced left on two approaches; and T intersection with displaced left on one approach) against a conventional intersection for a range of high entering volumes using VISSIM.⁽¹⁵⁰⁾ Operational benefits of the CFI were realized for all three CFI intersection configurations. For the case of the four-leg intersection with displaced left turns on all approaches, the following findings were documented:

- Average delay was reduced with the CFI by 48 to 85 percent compared to the conventional intersection, with the lower value applying to an undersaturated case and the upper value applying to an oversaturated case.
- The average number of stops with the CFI was reduced by 15 to 30 percent for undersaturated traffic flows and 85 to 95 percent for saturated traffic flow conditions at the conventional intersection.
- Queue lengths with the CFI were reduced by 62 to 88 percent compared to the conventional intersection, with the lower value applying to an undersaturated case and the upper value applying to an oversaturated case.

Goldblatt, Mier, and Friedman evaluated the performance of traffic at CFI designs by comparing it with the performance of conventional intersections under multiphase signal control.⁽¹⁵²⁾ Traffic demand was assumed equal on each approach leg to the intersection and turn movements were also assumed equal on each approach (15 percent left turns, 11 percent right turns). Traffic demand volumes for each approach were examined at 1,500, 2,000, and 3,000 vehicles per hour (veh/h). Key findings are as follows:

- At the 1,500 veh/h demand level, the demand was processed by both conventional and continuous flow intersections.
- At the 2,000 veh/h demand level, the capacity of the conventional intersection was exceeded (approximately by 20 percent) and the CFI serviced the entire demand.
- At the 3,000 veh/h demand level, the capacity of both the conventional intersection and the continuous flow intersection were exceeded. However, the capacity of the CFI nearly 50-percent greater than the conventional intersection.
- The advantages of the CFI are most pronounced when the demand approaches exceed the capacity of conventional designs and when heavy left-turn movements require protected phases.

In 1994 (the date of publication of Goldblatt, Mier, and Friedman), no known CFIs had been constructed.⁽¹⁵²⁾ Conclusions were drawn solely from operational simulation modeling. Actual

operational experience with CFIs are not widely available, but should become more so as more CFIs are built and evaluated.

Abramson, Bergen, and Goldblatt also note the potential for improved arterial performance with CFIs.⁽¹⁵³⁾ Because left-turn signal phasing is effectively removed with a CFI, expanded green bands along the arterial can be achieved.

Simulation studies using a range of intersection configurations (number of through lanes on the major and minor street) and volumes from intersections in Virginia and North Carolina suggest mixed results in overall travel time through the intersection when compared to a conventional intersection: -1 to +25 percent during off-peak conditions, and -12 to +27 percent during peak conditions. The studies also show a general increase in the overall percent of stops when compared to a conventional intersection: +21 to +87 percent during off-peak conditions, and +12 to +49 percent during peak conditions.⁽¹⁴⁵⁾

Multimodal impacts

Pedestrian safety is improved with the CFI design, according to Goldblatt et al.⁽¹⁵²⁾ Pedestrians cross at times when there are no conflicts with turning vehicles. Pedestrians do not require two sequential signal phases to complete a street crossing. However, the layout and operation of the intersection may not be immediately apparent to pedestrians, particularly those with visual disabilities. As a result, pedestrians with visual disabilities may have challenges in way-finding through the intersection. The unconventional flows of vehicles will disrupt the audible cues that visually impaired pedestrians use; therefore, accessible pedestrian signals should be considered for use with this intersection configuration.

Physical Impacts

The footprint of a continuous flow intersection is greater than that of a conventional intersection because it requires right-turn lanes and acceleration lanes in each quadrant. It takes less space than an interchange, however.

Socioeconomic Impacts

According to Goldblatt et al., the construction cost of a CFI may be two to three times the cost of a standard intersection design due to increased right-of-way costs, and the need for additional, coordinated signal controllers.⁽¹⁵²⁾

Enforcement, Education, and Maintenance

Additional potential roadblocks to continuous flow intersections include:

- Pedestrian acceptance (cross only at main intersection—no midblock crossing).
- Driver acceptance (vehicles may be opposed by traffic on both sides).
- Snow removal issues.
- Breakdown of vehicles.
- Providing access to adjacent parcels.
- With less intersection delay, improvements in air quality can be realized.

A public information campaign may be needed to educate drivers on the operation of the intersection. Abramson, Bergen, and Goldblatt provide a summary of a human factors study of continuous flow intersection operations.⁽¹⁵³⁾ Survey questionnaires were used to assess the learning curve of drivers utilizing a CFI in New York. Results indicated a positive response rate of 80 percent for first-time users of the design. After about a week of use, 100 percent of daily drivers expressed positive comments about the design. The basic conclusion is that unfamiliar drivers easily negotiate the intersection form and, after a short break-in period, nearly all drivers can become familiar and comfortable with the design. Key negative comments received in the survey dealt with adequate advance signing that must be provided. The authors detail the experience with one intersection only (and only one leg of the intersection had been designed as a CFI).

The use of extensive special directional signing is key to maximizing driver understanding and acceptance.

Summary

Table 79 summarizes the issues associated with CFI.

Table 79. Summary of issues for continuous flow intersections.

Characteristics	Potential Benefits	Potential Liabilities
Safety	Left turns removed from main intersection.	None identified.
Operations	More green for through.	More stops and delay for left turns.
Multimodal	No conflicts during pedestrian crossing.	Two-stage pedestrian crossing. Layout may not be immediately apparent, especially for visually impaired pedestrians.
Physical	Smaller footprint than interchange alternative.	Right-of-way needed. Larger footprint than conventional intersection. Access management.
Socioeconomic	Air quality.	Construction cost. Access management.
Enforcement, Education, and Maintenance	None identified.	Public information campaign may be needed.

10.2.4 Quadrant Roadway Intersection

A quadrant roadway intersection includes an extra roadway between two legs of the intersection (see figure 97). Drivers who wish to turn left from either the major or minor road will travel further to do so, but all left turns will be removed from the main intersection, as shown in figure 98. This design creates two additional intersections, which operate as three-phase signals, but the signal at the main intersection can operate as a two-phase signal, as shown in figure 99.

The signals at the quadrant ramps should be located a sufficient distance upstream of the main intersection to eliminate the potential for queue spillback. Reid identified a length of 150 m (500 ft) for his CORSIM evaluation.⁽¹⁵⁴⁾

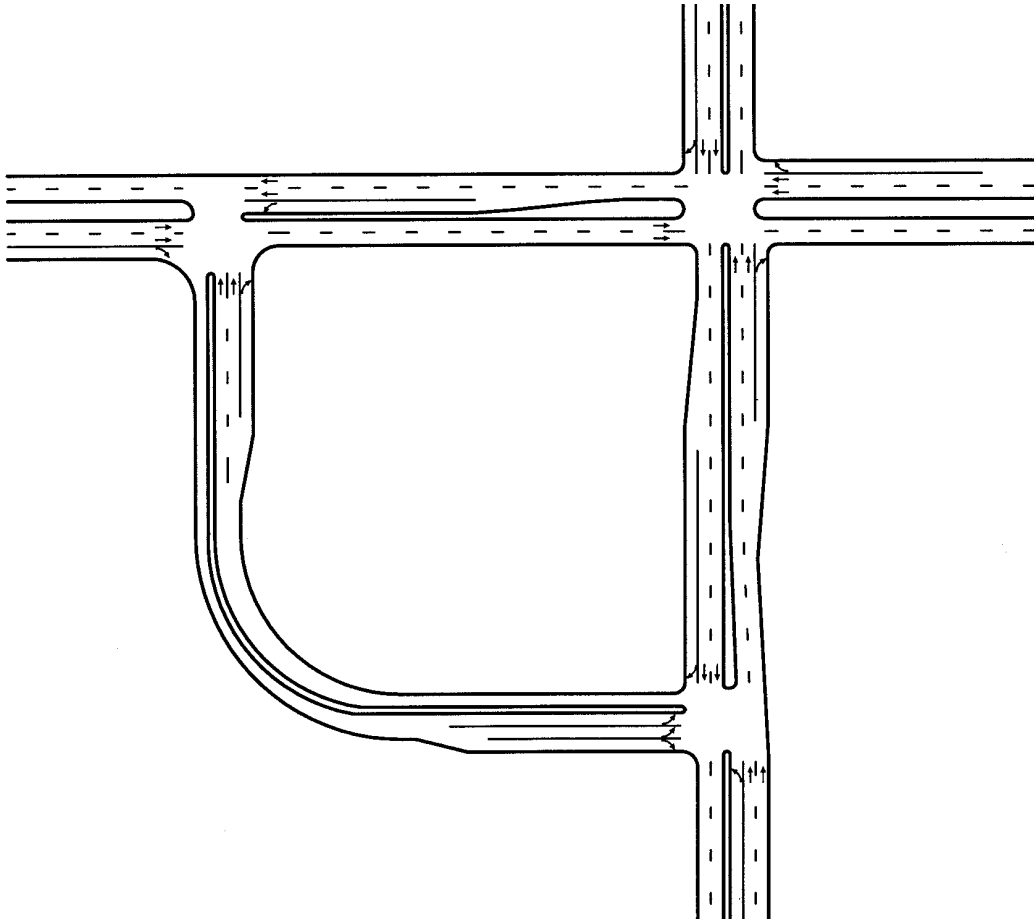


Figure 97. Diagram of a quadrant roadway intersection. (adapted from 145)

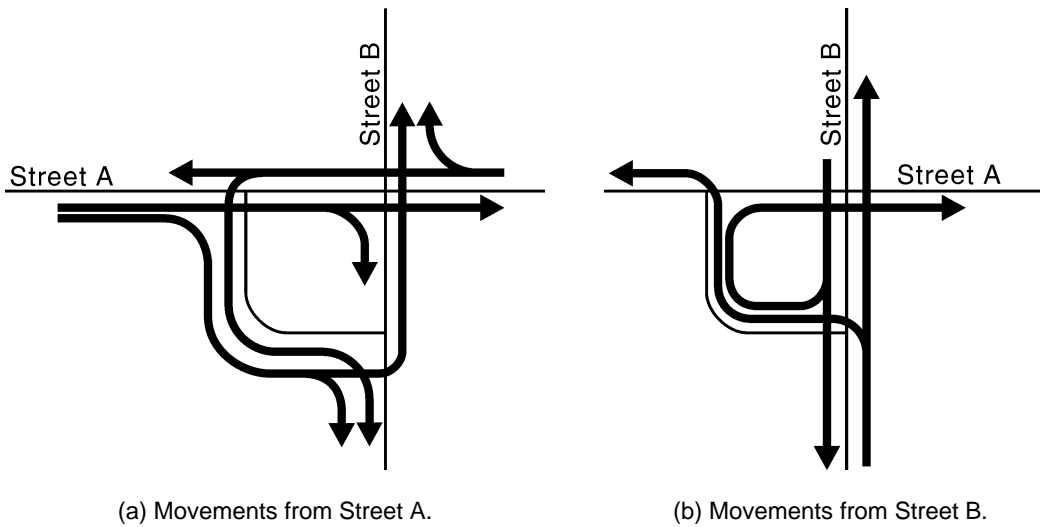


Figure 98. Vehicular movements at a quadrant roadway intersection. (adapted from 145)

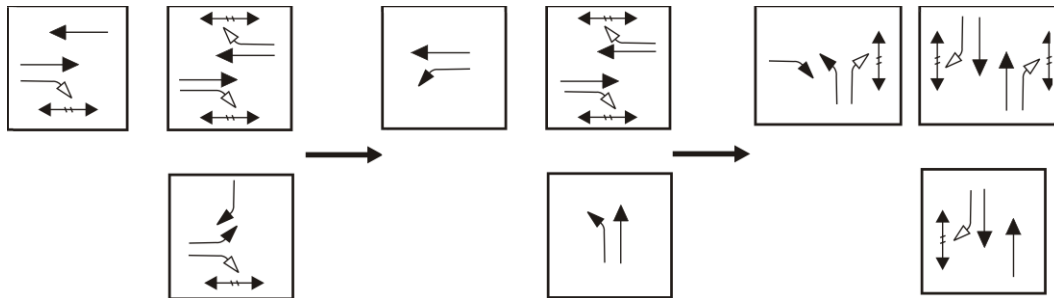


Figure 99. Signal phasing of a quadrant roadway intersection. (adapted from 141)

Applicability

Intersections of roadways with high through and turn movements may benefit from a quadrant roadway intersection design. If protected left turns at the main intersection are not necessary, more green time can be allocated to the through movements. This application can be useful where right-of-way is limited and there is an existing bypass street on any of the quadrants.

Safety Performance

Table 80 shows the number of conflict points at a four-leg signalized intersection as compared to a four-leg signalized intersection with a quadrant roadway. The number of merging/diverging conflict points would increase when a quadrant roadway is added. However, the number of crossing (left-turn) conflicts would decrease, provided that midblock restrictions are implemented at the original signalized intersection. Figure 100 shows the conflict point diagram for a four-leg signalized intersection with a quadrant roadway.

Table 80. Number of conflict points at a four-leg signalized intersection compared to a four-leg signalized intersection with a quadrant roadway

Conflict Type	Four-Leg Signalized Intersection	Four-Leg Signalized Intersection with a Quadrant Roadway
Merging/diverging	16	20
Crossing (left turn)	12	4
Crossing (angle)	4	4
Total	32	28

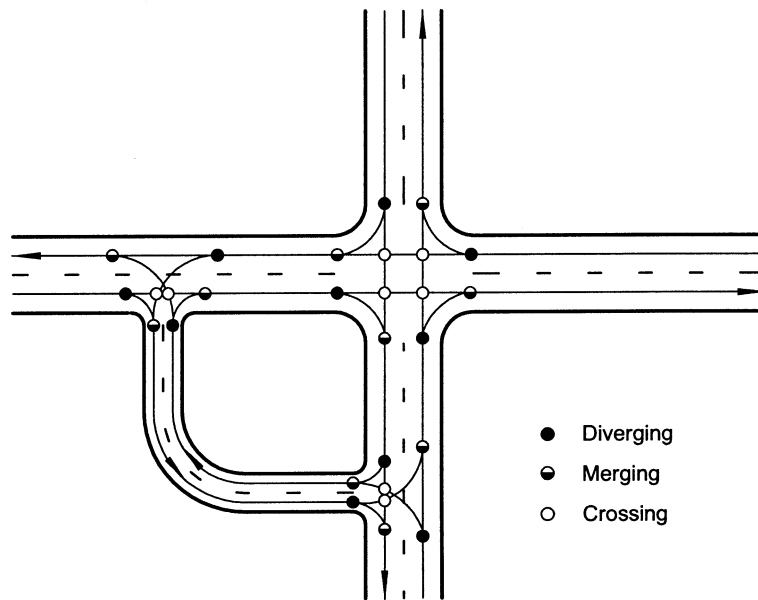


Figure 100. Conflict point diagram for four-leg signalized intersection with quadrant roadway.

Table 81 summarizes the expert opinion of the authors with regard to the safety benefits of adding a quadrant roadway to a four-leg signalized intersection.

Table 81. Safety benefits of adding a quadrant roadway to a four-leg signalized intersection: Expert opinion.

Treatment	Surrogate	Finding
Convert signalized four-leg Intersection to a quadrant roadway configuration	Conflict points	Offers the potential for a minor increase in rear-end collisions Offers the potential for a major decrease in left-turn collisions

Operational Performance

Compared with conventional intersections, quadrant roadway intersections have less total intersection delay and less queuing. There are conflict points at the primary intersection, which may result in lower crash rates for left-turn- and head-on-related crashes. The potential for driver confusion at these intersections is greater than that for conventional intersections, as it is with any alternative design. This can be addressed with advance signing.

A study that compared simulation of a quadrant roadway intersection with a conventional intersection showed a 22-percent reduction in system travel time. It is important that signals at these intersections be fully coordinated. The quadrant roadway intersection performed best under higher volumes.⁽¹⁴¹⁾

Simulation studies using a range of intersection configurations (number of through lanes on the major and minor street) and volumes from intersections in Virginia and North Carolina suggest a reduction in overall travel time through the intersection when compared to a conventional intersection: -21 to +1 percent during off-peak conditions, and -21 to -1 percent during peak conditions. The studies also show a general increase in the overall percent of stops when

compared to a conventional intersection: –12 to +96 percent during off-peak conditions, and –3 to +33 percent during peak conditions.⁽¹⁴⁵⁾

Summary

Table 82 summarizes the issues associated with quadrant roadways.

Table 82. Summary of issues for quadrant roadways.

Characteristic	Potential Benefits	Potential Liabilities
Safety	Potential major decrease in left-turn collisions.	Potential minor increase in rear-end collisions.
Operations	Potential reduction in delay and queuing.	None identified.
Multimodal	Pedestrian crossing distance at each intersection may decrease.	Number of intersections to cross increases.
Physical	None identified.	If the quadrant roadway does not exist, may be high construction and right-of-way costs.
Socioeconomic	None identified.	None identified.
Enforcement, Education, and Maintenance	None identified.	Greater potential for driver confusion.

10.2.5 Super-Street Median Crossover

The super-street median crossover improves operation of the main road through maneuver, and also reduces delay for left turns off the major road.

Description

The super-street median crossover design, shown in figure 101, is similar to the median U-turn crossover in that an indirect maneuver is accomplished with a U-turn in the median. With a super-street median crossover, crossroad drivers cannot proceed straight through the intersection, as can be seen in figure 102. A through movement is accomplished by turning right onto the major road, turning left through the crossover, and turning right again back onto the minor road. Also, as with the median U-turn design, drivers are not able to turn left from the crossroad onto the major road, and a median U-turn is used to accomplish the left-turn maneuver. Left turns from the major road are direct.

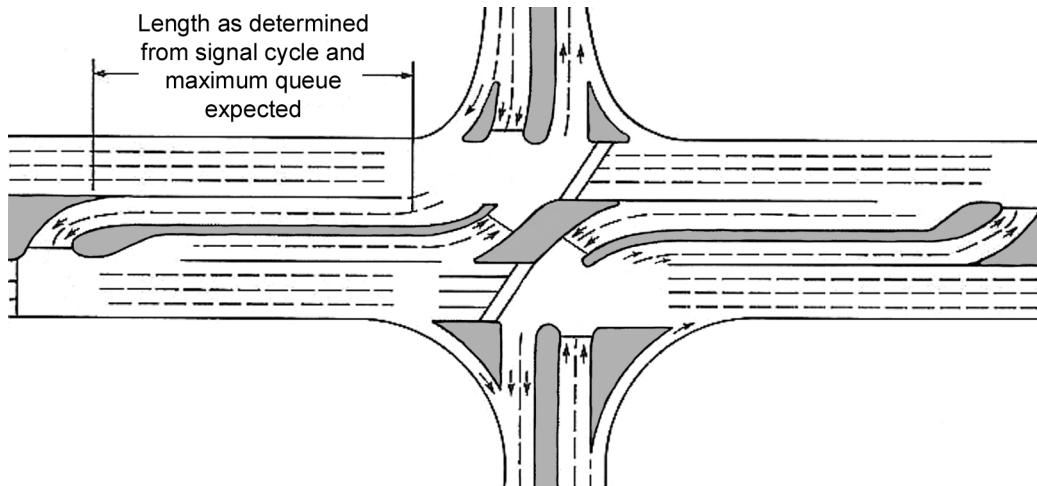


Figure 101. Illustration of super-street median crossover. (adapted from 155)

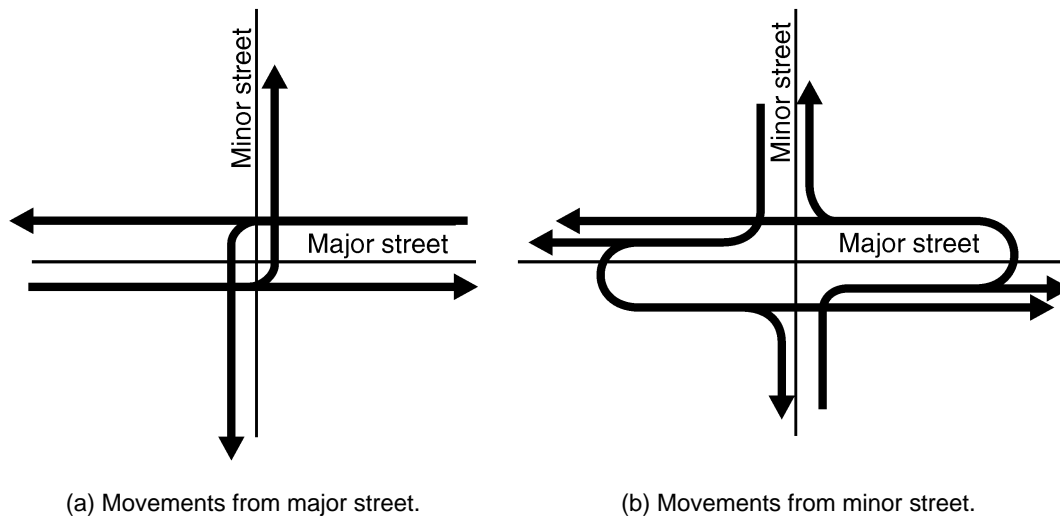


Figure 102. Vehicular movements at a super-street median crossover.

The design of a super-street median crossover is similar to that of a median U-turn crossover. Crossovers should be located approximately 180 m (600 ft) from the main intersection. A semi-trailer combination design vehicle would need a median width of 18 m (60 ft) to accommodate a U-turn. Additional right-of-way would not be required to construct this treatment where the major streets already have a wide median.

Two two-phase traffic signals are required at the main intersection—one for each minor street approach. Because no minor street through or left-turn movements are allowed, these two signals can operate independently with different signal cycle lengths, if desired. A typical phasing diagram is shown in figure 103, which shows the phasing for each of the two-phase signals on each half of the intersection. In addition, a traffic signal may be needed at each of the upstream median crossover locations; these signals would also have only two phases. Because the two halves of the intersection operate independently, it is possible to achieve a maximum amount of traffic progression in both directions along the major street.

There are fewer conflict points with this intersection design than with conventional intersections. Though this design may cause confusion for pedestrians, there is less opportunity for conflicts with vehicles. The crossing is a two-stage process.

This design is appropriate in situations where there are high through volumes on the major road but only relatively low volumes of through traffic on the cross road, since this through movement is interrupted. For crossroads with higher through volumes, offset super-street crossover design can be used. With this design, the approaches on the crossroad are offset, and are at the same location as the median crossovers. This allows minor road through vehicles to proceed straight from the crossover to the crossroad without turning.

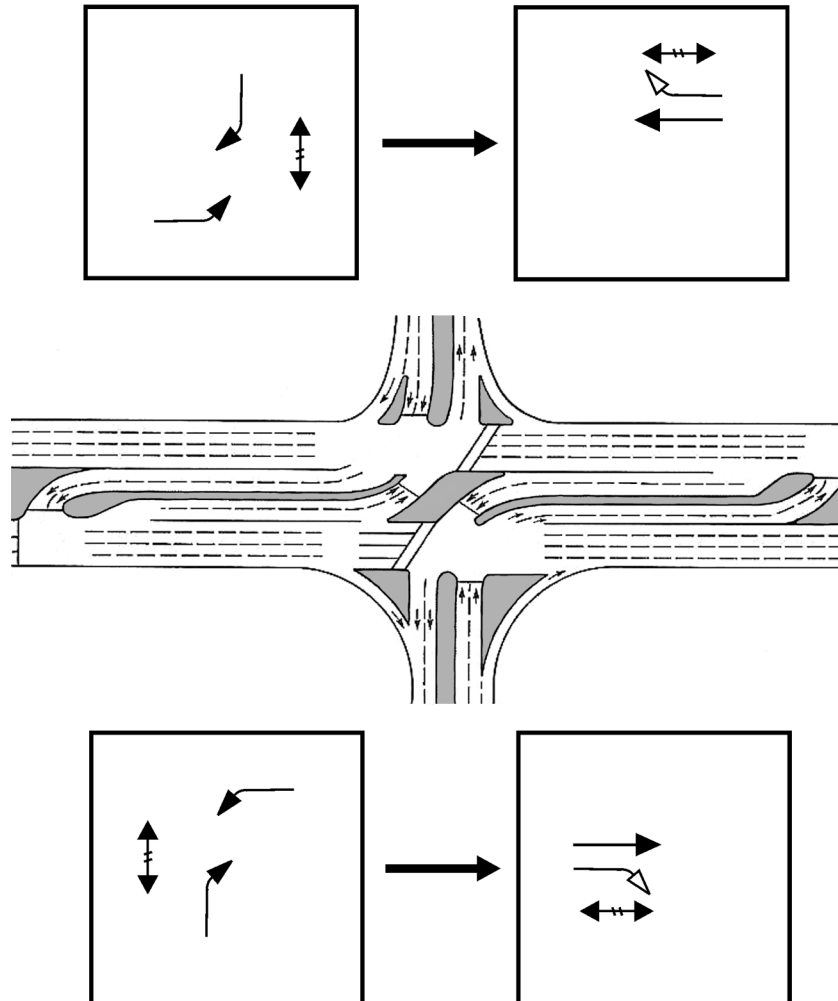


Figure 103. Signal phasing of a super-street median crossover.

Safety Performance

Table 83 shows the number of conflict points at a four-leg signalized intersection as compared to a super-street median crossover. The number of left-turn crossing conflicts would be reduced to two at a super-street median crossover. No crossing (angle) conflict points exist at a super-street median crossover. Figure 104 shows the conflict point diagram for a super-street median crossover.

Table 83. Number of conflict points at a four-leg signalized intersection compared to a super-street median crossover.

Conflict Type	Four-Leg Signalized Intersection	Super-Street Median Crossover
Merging/diverging	16	18
Crossing (left turn)	12	2
Crossing (angle)	4	0
Total	32	20

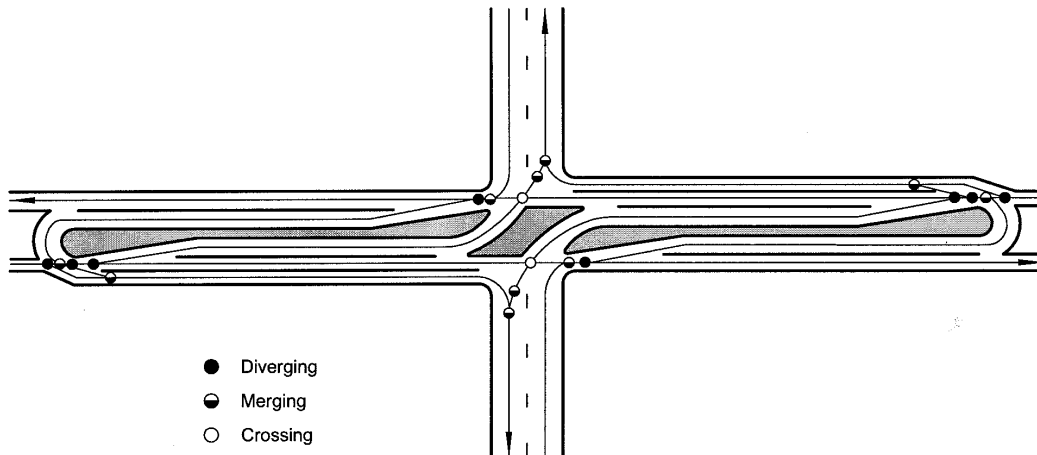


Figure 104. Conflict diagram for a super-street median crossover.

Table 84 summarizes the expert opinion of the authors with regard to the safety benefits of changing a four-leg signalized intersection to a super-street median crossover.

Table 84. Safety benefits of converting a four-leg signalized intersection to a super-street median crossover: Expert opinion.

Treatment	Surrogate	Finding
Convert signalized Four-leg intersection to super-street median crossover	Conflict points	Offers the potential for a major reduction in midblock collisions Offers the potential for a major reduction in angle collisions

Operational Performance

This design can result in more stops for through vehicles than other designs. It also creates out-of-direction travel for cross street through and left-turn movements, which limits their capacity and increases their travel times. Left turns from the major road experience less delay, however.

Simulation studies using a range of intersection configurations (number of through lanes on the major and minor street) and volumes from intersections in Virginia and North Carolina suggest mixed results in overall travel time through the intersection when compared to a conventional intersection: -8 to +18 percent during off-peak conditions, and -10 to +71 percent during peak conditions. The studies also show a substantial increase in the overall percent of stops when compared to a conventional intersection: -8 to +187 percent during off-peak conditions, and +16 to +146 percent during peak conditions.⁽¹⁴⁵⁾

A study of a Michigan corridor comparing TWLTL to median U-turn crossovers also looked at super-street median crossovers. The study showed that during peak hours, travel time on the

corridor with super-street median crossovers decreased by 10 percent; average speed was 15 percent higher than in the same corridor with a TWLTL. In nonpeak hours, the super-street median crossovers had the same efficiency as the TWLTL, even though a higher delay for left-turning vehicles had been expected due to the higher travel distance for a vehicle to turn left using a median crossover.⁽¹⁴⁹⁾

While travel time and delay will increase for cross street through and left-turn traffic, the major road through and left-turn movements will experience an improvement in intersection operations. Driver opinions and acceptance of the intersection design may vary according to which maneuver a driver typically makes at the intersection.

Enforcement, Education, and Maintenance

Super-street median crossovers have not been constructed in nearly as many locations as median U-turn crossovers. This treatment has not been implemented for an entire corridor. Therefore, opportunities for public response to the crossovers are low.

Little enforcement will be needed for this design. It may be necessary to occasionally provide enforcement of traffic control devices at the median crossovers.

There is a potential for driver and pedestrian confusion with this design. A public information campaign may be desirable in order to prepare drivers for the opening of the new intersection. Signs guiding drivers through the intersection will be appropriate, especially in areas where super-street median crossovers are not common.

Summary

Table 85 summarizes the issues associated with the super-street median crossover.

Table 85. Summary of issues for super-street median crossovers.

Characteristic	Potential Benefits	Potential Liabilities
Safety	Fewer conflict points.	None identified.
Operations	Improved delay for major street movements.	Longer travel distance and time for minor street movements.
Multimodal	None identified.	Two-stage pedestrian crossing. Potential way-finding challenges.
Physical	None identified.	Wide median needed.
Socioeconomic	None identified.	May result in restrictions to access.
Enforcement, Education, and Maintenance	None identified.	Potential for driver and pedestrian confusion.

10.3 GRADE SEPARATION TREATMENTS

Grade separation treatments should be considered when at-grade intersection treatments are no longer feasible. Grade separation is costly, has substantial impacts on traffic during construction, and substantially affects pedestrians, bicyclists, and adjacent land uses. Grade separation does provide a significant benefit to the operations of through movements given that conflicts with opposing and adjacent traffic are eliminated. The reduction of conflicts also improves safety performance.

The following sections discuss the split intersection and diamond interchange forms. Although the split intersection is an at-grade form, it is a logical intermediate stage to complete grade separation and thus is discussed in this section.

10.3.1 Split Intersection

Description

A split intersection, shown in figure 105, requires that the major road approaches to an intersection be converted into two one-way streets. Essentially, the split intersection becomes an at-grade diamond configuration. Rather than one intersection that would operate as a four-phase signal (assuming protected left-turn phasing), two intersections are created that can operate as three-phase signals. The split intersection can be a potential “stage” to constructing a diamond (or other) interchange. According to Bared and Kaiser, the split intersection facilitates smoother traffic flows with less delay and also may improve safety by reducing the number of intersection conflict points.⁽¹⁵⁶⁾

Applicability

A split intersection may be considered where:

- Significant delays occur.
- A high number of left-turn collisions occur.

Safety Performance

According to two studies split intersections can have the following safety benefits:^(156,157)

- Separation of intersection conflict points.
- Possible safety improvement because of separation of conflicts and reduction in signal phases (reduction in phases is related to likelihood that drivers will violate the traffic signal).

However, with the split intersection design, there is the possibility of wrong-way movements.

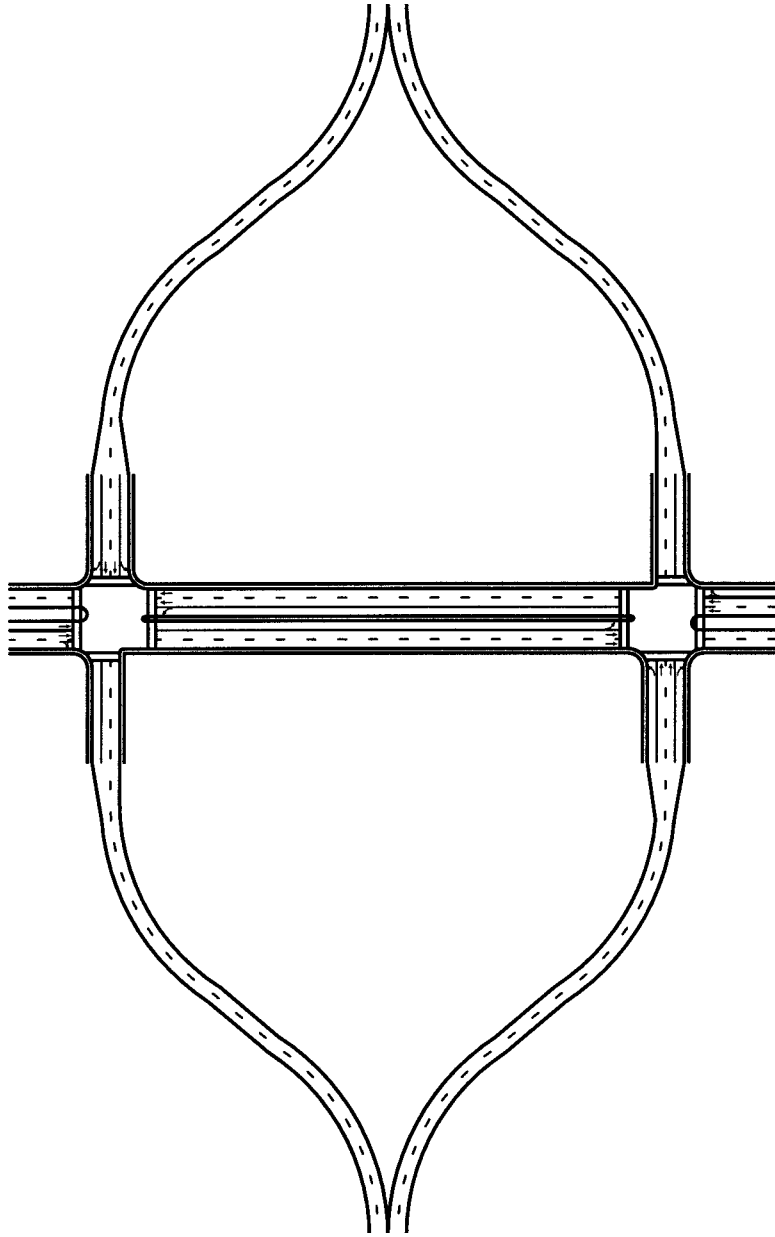


Figure 105. Illustration of a split intersection. (adapted from 145)

Table 86 shows the number of conflict points at a four-leg signalized intersection as compared to a split intersection. A split intersection would have the same number of merging/diverging and crossing (angle) conflict points as a four-leg signalized intersection. However, there are only 6 crossing (left-turn) conflict points at a split intersection, compared to 12 at a four-leg signalized intersection. Figure 106 shows the conflict point diagram for a split intersection.

Table 86. Number of conflict points at a four-leg signalized intersection compared to a split intersection.

Conflict Type	Four-Leg Signalized Intersection	Split Intersection
Merging/diverging	16	12
Crossing (left turn)	12	6
Crossing (angle)	4	4
Total	32	22

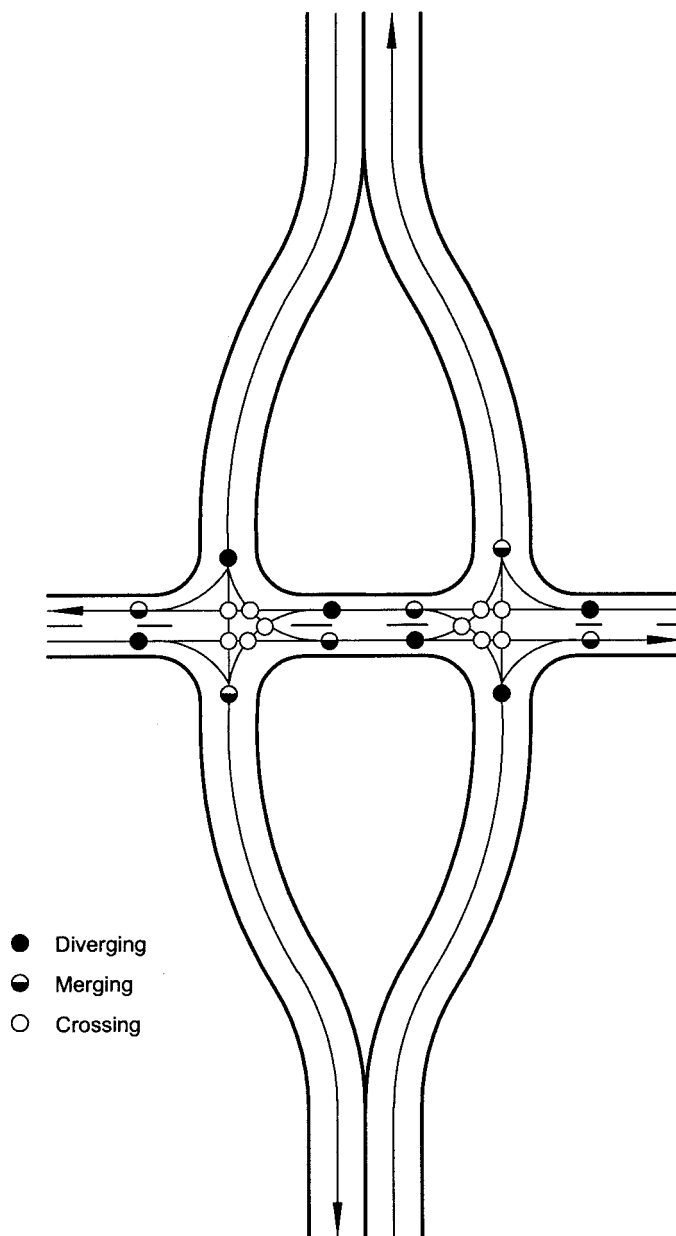


Figure 106. Conflict point diagram for a split intersection.

Table 87 summarizes the expert opinion of the authors with regard to the safety benefits of a conversion of a four-leg signalized intersection to a split intersection.

Table 87. Safety benefits of converting a four-leg signalized intersection to a split intersection: Expert opinion.

Treatment	Surrogate	Implication
Convert signalized four-leg intersection to a split intersection	Conflict points	Offers the potential for a significant decrease in left-turn collisions

Operational Performance

Conversion to a split intersection (versus a standard intersection) can result in substantial increases in effective green time available to traffic.⁽¹⁵⁷⁾ This increase becomes even larger when the percentage of left-turning traffic rises. The minimum recommended spacing is 50 m (165 ft) and increases as a function of signal cycle length and left-turning volume.

Bared and Kaisar performed a traffic simulation (using CORSIM) to compare a standard four-leg intersection and a split intersection.⁽¹⁵⁶⁾ Optimum traffic signal timing plans for both intersection configurations were developed using PASSER[®]. Results of the CORSIM analysis reveal that the split intersection is able to handle higher traffic volumes with less delay per vehicle than is a single intersection. As the entering volume and proportion of left-turning vehicles increases, the advantage of the split intersection relative to the standard intersection increases (in terms of reducing delay). Average delays for both intersections are similar for intersections with a total entering flow of 4,000 veh/h and less. At higher entering volumes (5,000 to 6,000 veh/h), the reduction in delay with a split intersection was on the order of 40 to 50 percent. This increases as the percent of left-turning traffic increases from 15 to 30 percent of the total traffic.

A limited number of split intersections have been constructed (none known in the United States). As such, operational experience with split intersections is limited. Operational experience and public response to one constructed in Israel has been positive.⁽¹⁵⁶⁾ Other split intersections in Israel have been converted to grade-separated interchanges. The majority of conclusions regarding split intersections have been gained from computer simulation runs of anticipated traffic operations.

Simulation studies using a range of intersection configurations (number of through lanes on the major and minor street) and volumes from intersections in Virginia and North Carolina suggest a general reduction in overall travel time through the intersection when compared to a conventional intersection: -20 to -8 percent during off-peak conditions, and -15 to +9 percent during peak conditions. The studies also show an increase in the overall percent of stops when compared to a conventional intersection: +21 to +87 percent during off-peak conditions, and +12 to +49 percent during peak conditions.⁽¹⁴⁵⁾

Split intersections can have the following operational benefits:^(156,157)

- Increase capacity and reduce delay relative to a standard intersection.
- Provide a stage to construction of a grade-separated interchange.

Operational liabilities are the likelihood that the design will require two stops (versus one) in a poorly coordinated system.

Multimodal Impacts

At split intersections, pedestrian crossing distances (for the cross street) are significantly reduced. Because these types of intersections have the look and feel of a grade-separated interchange, pedestrians may find them intimidating, and motorists may be less aware of pedestrians' presence.

Physical Impacts

These types of intersections would have a high initial construction cost yet provide a preliminary stage to eventual grade separation.

Socioeconomic Impacts

A split intersection would have additional right-of-way requirements.

Summary

Table 88 summarizes the issues associated with constructing a split intersection.

Table 88. Summary of issues for split intersections.

Characteristic	Potential Benefits	Potential Liabilities
Safety	Reduced left-turn collisions.	Wrong-way movements.
Operations	Frees up green time for through movements.	None identified.
Multimodal	Shorter crossing distance.	May not be perceived as being pedestrian friendly.
Physical	Preliminary stage to grade separation.	High initial construction costs.
Socioeconomic	None identified.	Right-of-way requirements.
Enforcement, Education, and Maintenance	None identified.	None identified.

10.3.2 Diamond Interchange

Description

A diamond interchange is a treatment where the through movements on the major street are physically separated from the other turning movements, which are typically served by one or two intersections (ramp terminals) on the minor street. On- and off-ramps connect the major street to these ramp terminals, forming the shape of a diamond. Diamond interchanges have a variety of forms, and their function depends on the separation between the two ramp terminals and the associated traffic control strategy. Two of the more common types of diamond interchanges used in constrained urban environments are the single-point diamond and compressed diamond. Additional information on other interchange forms can be found in the AASHTO policy.⁽³⁾

A single-point diamond interchange (also referred to as a single-point urban interchange, or SPUI, although these interchanges are not inherently restricted to urban environments) operates as a single signalized intersection. Left turns from the ramps and on the cross street are aligned such that they oppose each other, eliminating a potential source of conflict. Because of the layout of the interchange, at-grade movements are served by a three-phase signal, although relatively long cycle lengths are typical. This is in part due to the fact that longer clearance intervals are required for a single-point interchange to allow vehicles to depart the intersection. Figure 107 shows a typical single-point interchange.

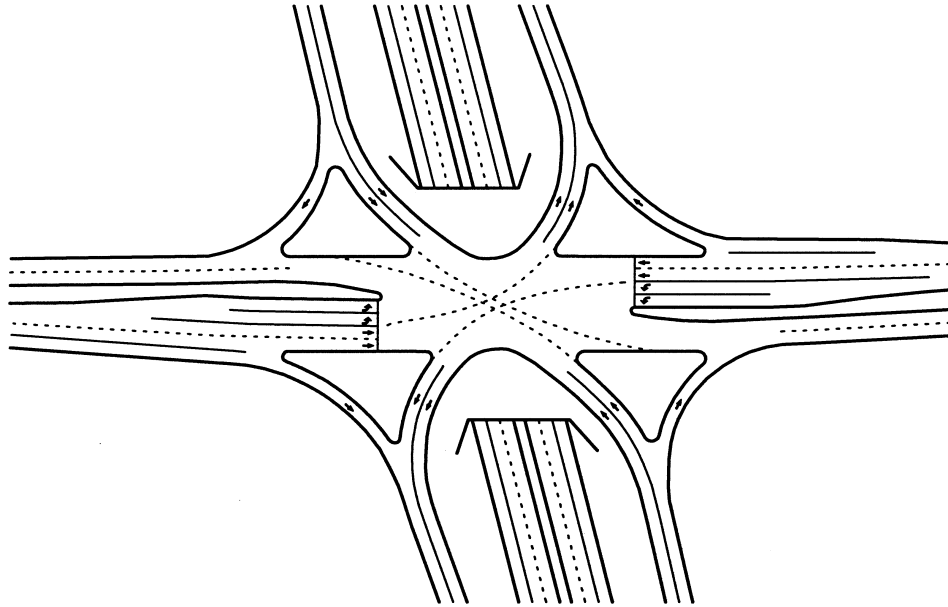


Figure 107. Diagram of a single-point interchange. (adapted from 158)

A compressed diamond interchange (also referred to as a tight diamond interchange) operates as two closely spaced intersections, typically controlled by four-phase overlap signal phasing system for the two intersections. Layout of the left turns on the cross street are back to back, resulting in an increased cross section across/under the bridge relative to a single-point interchange. Even with this increased cross section, there is less open pavement area at a compressed diamond interchange relative to a single-point interchange, which allows for shorter clearance intervals. Figure 108 shows a typical compressed diamond interchange.

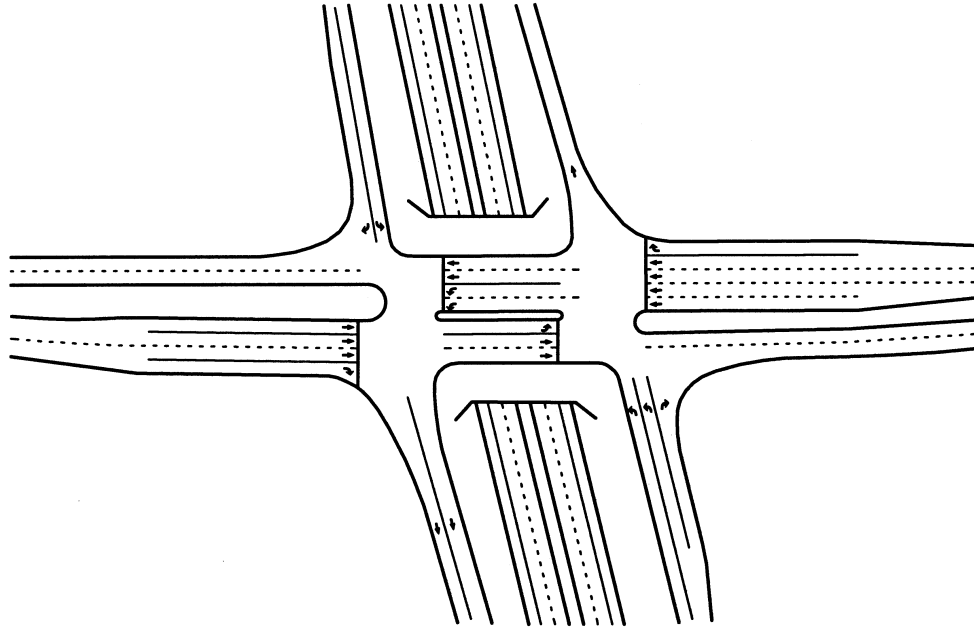


Figure 108. Diagram of a compressed diamond interchange. ^(adapted from 158)

A single-point interchange can operate with three or four phases; a three-phase signal phasing scheme is illustrated in figure 109. As can be noted from the phasing diagram, pedestrian movements across the arterial street or through movements on the ramp (as with frontage roads) cannot be accommodated without adding a fourth phase.

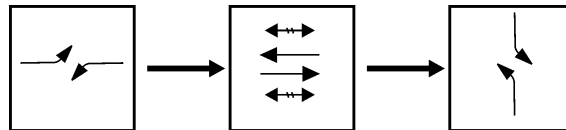


Figure 109. Typical signal phasing of a single-point interchange.

The compressed diamond interchange can operate with three or four phases; a four-phase signal phasing scheme is illustrated in figure 110. The figure shows the coordinated operation of the signals on each side of the interchange. This phasing scheme can accommodate pedestrians in all directions.

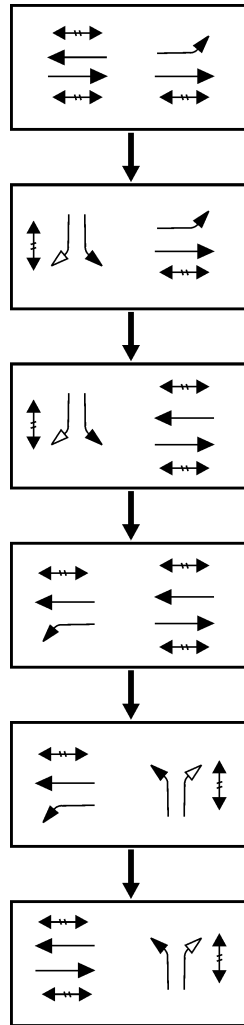


Figure 110. Typical signal phasing of a compressed diamond interchange.

Applicability

Inconsistent findings relating to the single-point and compressed diamond interchange forms relate primarily to the operational and safety performance of each form. As analysis procedures and site conditions differ for each interchange application, it is difficult to draw firm conclusions regarding the merits of a particular interchange form without appropriately studying the specific conditions of a site.

Safety Performance

Safety information on the single-point interchange is limited. Smith and Garber report some safety findings, but indicate the findings may be more representative of changing design details than of true safety differences.⁽¹⁵⁹⁾ Leisch, Urbanik, and Oxley suggest that the potential for higher crash experience is present at single-point interchanges because of the large, uncontrolled pavement area and the opposing left turns.⁽¹⁶⁰⁾ No crash data are provided, however.

Smith and Garber report that driver unfamiliarity with the new single-point interchange design was not a major factor in crash occurrence at the interchange, although there were complaints of confusion at single-point interchanges shortly after it was opened.⁽¹⁵⁹⁾ Rear-end crashes on the off-ramp were the predominant crash type. A study by Messer et al. indicated that the single-point

interchange design does not lead to a higher number of crashes than found in a typical at-grade intersection.⁽¹⁶¹⁾

Table 89 shows the number of conflict points at a four-leg signalized intersection as compared to a compressed diamond and single-point diamond interchange. The compressed diamond interchange would have a greater number of merging/diverging conflict points as compared to a four-leg signalized intersection. Both the compressed diamond and single-point diamond interchange would have fewer crossing (left-turn) conflict points. The single-point diamond interchange would have no crossing (angle) conflict points. Figures 111 and 112 show the conflict point diagrams for a single-point diamond and compressed diamond interchange, respectively. Table 90 summarizes the expert opinion of the authors with regard to the safety benefits of a conversion of a four-leg signalized intersection to a compressed diamond and single-point diamond interchange.

Table 89. Number of conflict points at a four-leg signalized intersection compared to a compressed diamond and single-point diamond interchange.

Conflict Type	Four-Leg Signalized Intersection	Compressed Diamond	Single-Point Diamond
Merging/diverging	16	20	16
Crossing (left turn)	12	6	8
Crossing (angle)	4	4	0
Total	32	30	24

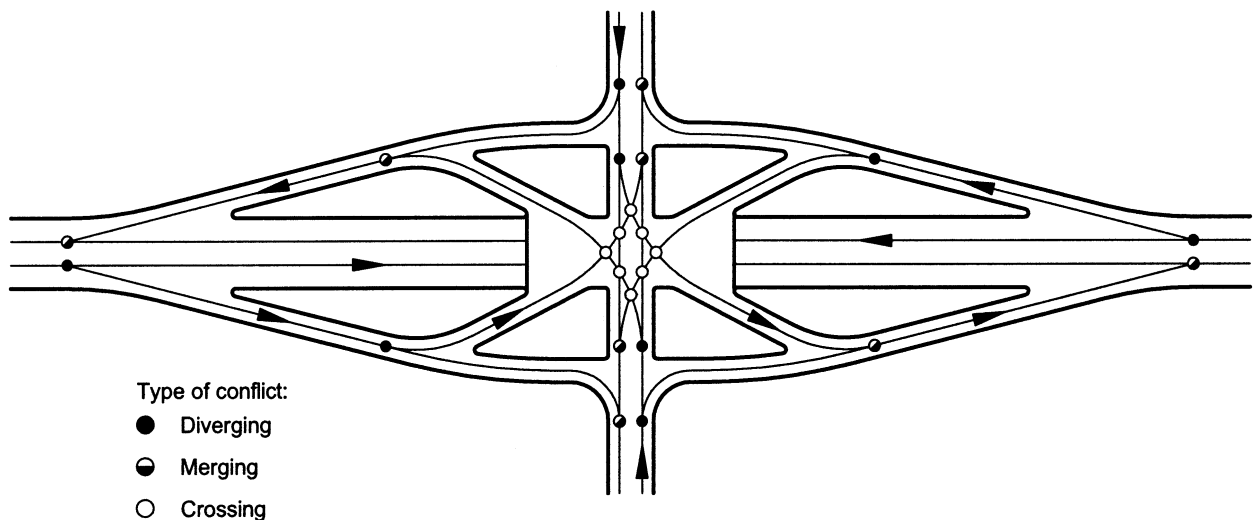


Figure 111. Single-point diamond interchange conflict point diagram.

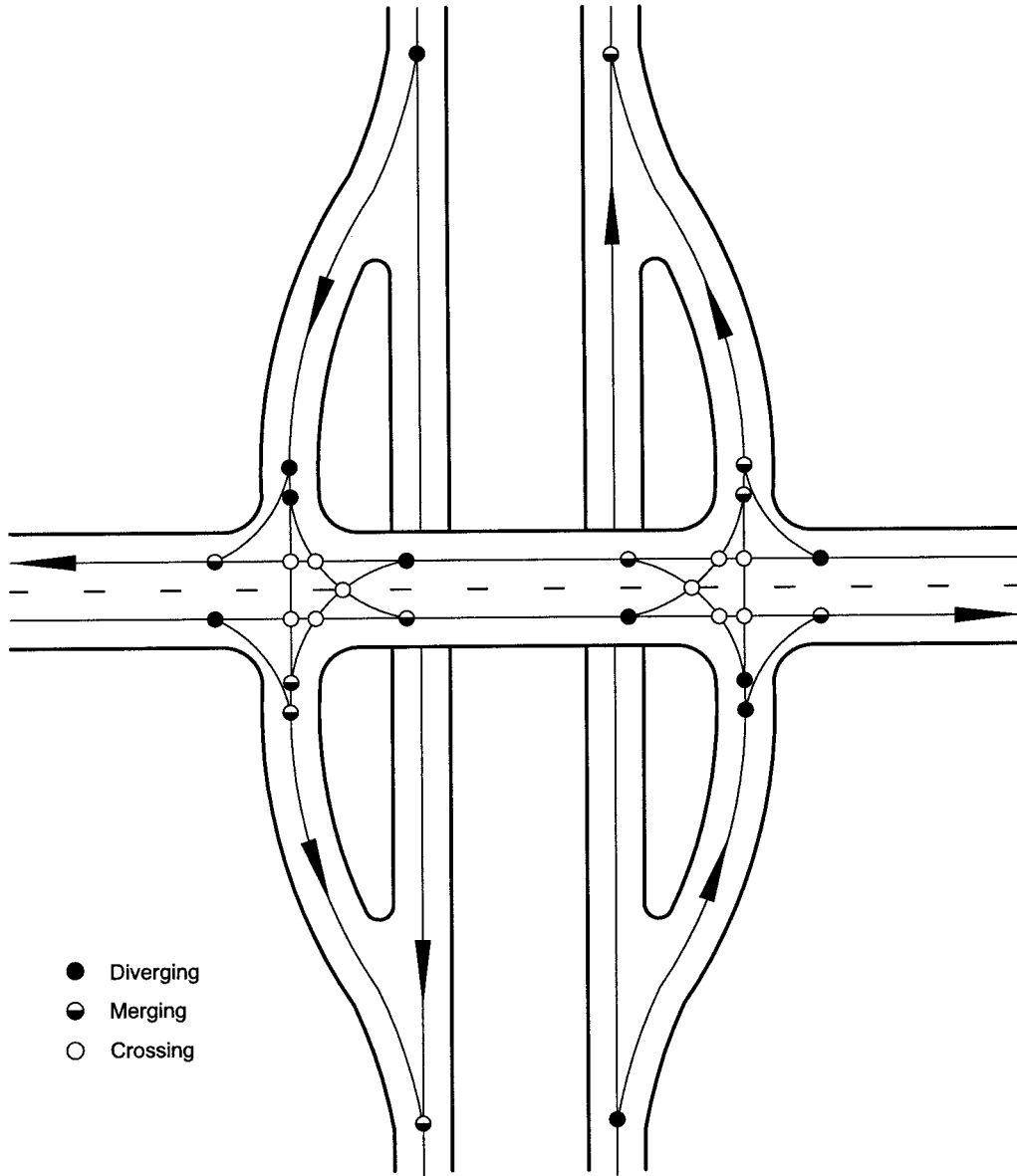


Figure 112. Compressed diamond interchange conflict point diagram.

Table 90. Safety benefits of converting a four-leg signalized intersection to a compressed diamond and single-point diamond interchange: Expert opinion.

Treatment	Surrogate	Implication
Convert signalized four-leg intersection to a compressed diamond interchange	Conflict points	Offers the potential for a significant decrease in collisions involving major street through traffic Offers the potential for a minor increase in merge/diverge collisions Offers the potential for a significant decrease in midblock collisions
Convert signalized four-leg intersection to a single-point diamond interchange	Conflict points	Offers the potential for a significant decrease in collisions involving major street through traffic Offers the potential for a significant decrease in midblock collisions Offers the potential for a major decrease in angle collisions

Operational Performance

With regard to the single-point interchange, left turns off the cross street are typically accommodated at 135-degree angles, while left turns at the ramps are typically 45 to 60 degrees. Because the left turns from the ramps are at a relatively shallow angle, these movements can take place at higher speeds and at higher saturation flow rates relative to a compressed diamond interchange. Saturation flow rates for the left turns from the ramp at a single-point interchange approach those for a through movement.⁽¹⁶²⁾

Similar to the single-point interchange, a compressed diamond interchange can be constructed in a relatively confined right-of-way while serving high traffic demand volumes. A more conventional structure can be used to allow future modifications, if needed. In addition, the compressed diamond design can serve pedestrians effectively and work in combination with frontage roads without a substantial decrease in the efficiency of the interchange.

A single-point interchange combined with a frontage road would also decrease the overall efficiency of the interchange, as additional phases are required at the signal to serve traffic movements.

Operational analyses of the two types of interchanges are mixed, with some studies reporting the single-point interchange as superior to the compressed diamond interchange in most circumstances, some reporting the opposite, and others reporting no significant difference. Several simulation-based studies have been performed that indicate that the single-point interchange performs better than a compressed diamond interchange for many volume scenarios.^(158,163) Fowler reports that in most traffic scenarios, the single-point interchange provides more capacity than a compressed diamond interchange and that the capacity of the compressed diamond interchange is more sensitive to traffic volumes than is the single-point interchange.⁽¹⁶²⁾ The performance of the compressed diamond interchange improves relative to the single-point interchange when the:

- Directional split of the cross-street through volume increases.
- Volume of the cross-street left turns increases.
- Off-ramp left turns become more unbalanced.

On the other hand, Leisch, Urbanik, and Oxley found that the compressed diamond is more efficient than the single-point interchange for most traffic volume/pattern situations.⁽¹⁶⁰⁾ Bonneson and Lee found similar results when frontage roads are present.⁽¹⁶⁴⁾ Both studies show that the compressed diamond interchange can accommodate a greater variability of traffic patterns than the single-point interchange, and the cycle length requirements are shorter for the compressed diamond than the single-point interchange. Because of these wide variations in recommendations,

no simple conclusion regarding operational performance can be made, and case-by-case analysis is therefore recommended.

Multimodal Impacts

Pedestrian issues are sensitive at a single-point interchange. At a single-point interchange, there is no phase to provide for pedestrian movements. Pedestrians will need two phases to cross the roadway (and require an adequate refuge area). Addition of an exclusive pedestrian phase would decrease the overall efficiency of the interchange.

Physical Impacts

An advantage of the single-point interchange is that the interchange can be constructed in a relatively confined right-of-way while serving high traffic demand volumes. However, deep span lengths are required with both overpass and underpass designs. The structure for a single-point interchange can be more difficult to modify to meet future needs than that for a compressed diamond interchange.

Socioeconomic Impacts

The primary disadvantage of a single-point interchange is the high construction cost of the bridge structure.

Summary

Table 91 summarizes the issues associated with constructing a single-point or compressed diamond interchange.

Table 91. Summary of issues for single-point and compressed diamond interchanges.

Characteristic	Potential Benefits	Potential Liabilities
Safety	Single-point: Potential for decrease in all types of collisions. Compressed diamond: Potential for decrease in major-street through movement and left-turn collisions.	Compressed diamond: Potential for minor increase in merge/diverge collisions.
Operations	Mixed results.	Mixed results.
Multimodal	Compressed diamond: All pedestrian movements can be served.	Single-point: Pedestrians cannot be served on all movements without adding a pedestrian phase.
Physical	Single-point: May be constructable in confined right-of-way.	Compressed diamond: May require more right-of-way.
Socioeconomic	Compressed diamond: Likely has a lower cost due to the structure.	Single-point: Likely has a higher cost due to the structure.
Enforcement, Education, and Maintenance	None identified.	None identified.

CHAPTER 11

APPROACH TREATMENTS

TABLE OF CONTENTS

11.0	APPROACH TREATMENTS	279
11.1	Signal Head Placement and Visibility	279
11.1.1	Convert to Mast Arm or Span Wire Mounted Signal Heads	280
11.1.2	Add Near-Side Signal Heads	281
11.1.3	Increase Size of Signal Heads	282
11.1.4	Use Two Red Signal Sections	284
11.1.5	Increase Number of Signal Heads	286
11.1.6	Provide Backplates	288
11.1.7	Provide Advance Warning	290
11.2	Signing and Speed Control Treatments	292
11.2.1	Improve Signing	292
11.2.2	Reduce Operating Speed	294
11.3	Roadway Surface Improvements	294
11.3.1	Improve Pavement Surface	294
11.3.2	Provide Rumble Strips	297
11.3.3	Improve Cross Section	298
11.3.4	Remove Obstacles from Clear Zone	300
11.4	Sight Distance Treatments	301
11.4.1	Improve Sight Lines	301

LIST OF FIGURES

<u>Figure</u>		<u>Page</u>
113	Signal head with a double red signal indication	285
114	Lane-aligned signal heads	287
115	Illustration of sight distance triangles	302

LIST OF TABLES

<u>Table</u>		<u>Page</u>
92	Summary of approach treatments	279
93	Safety benefits associated with using mast arms: Selected findings	280
94	Summary of issues for using mast arm/span wire mounted signal heads	281
95	Summary of issues for supplemental near-side traffic signal heads	282
96	Safety benefits associated with using 300-mm (12-inch) signal lenses: Selected findings	283
97	Summary of issues for increasing the size of signal heads	284
98	Safety benefits associated with using a double red indication (red "T") display: Selected findings	285
99	Summary of issues for using two red signal sections	286
100	Safety benefits associated with addition of a signal head: Selected findings	288
101	Summary of issues for adding a signal head	288
102	Safety benefits associated with the use of signal backplates: Selected findings	289
103	Summary of issues for using signal head backplates	290
104	Safety benefits associated with advance warning signs and flashers: Selected findings	291
105	Summary of issues related to advance warning treatments	292
106	Safety benefits associated with sign treatments: Selected findings	293
107	Summary of issues for improving signing	294

CHAPTER 11 TABLES, CONTINUED

<u>Table</u>	<u>Page</u>
108 Safety benefits associated with nonskid treatments, drainage improvements, or resurfacing: Selected findings	296
109 Summary of issues for pavement treatments	297
110 Safety benefits associated with rumble strips: Selected findings	297
111 Summary of issues for rumble strips.	298
112 Summary of issues for cross section improvements	300
113 Summary of issues for removing obstacles from the clear zone	301
114 Expected reduction in number of crashes per intersection per year by increased sight distance	303
115 Safety benefits associated with sight distance improvements: Selected findings.....	303
116 Summary of issues for visibility improvements.....	304

11. APPROACH TREATMENTS

Approaches are critical components of a signalized intersection. It should be obvious to someone approaching by motor vehicle, bicycle, or on foot that an intersection is ahead, and the traffic control device is a traffic signal. Adequate signing and pavement marking is required to provide the driver with sufficient information to determine the appropriate lane to choose and direction to travel. The pavement on the approaches should provide the driver with a smooth, skid-resistant surface, with adequate drainage. The approaches ideally should meet at right angles and should be at grade and free of unnecessary clutter and obstacles. Sight distance for all approaches should be adequate for drivers proceeding through the intersection, particularly those making a left turn.

This chapter will discuss various treatments related to signalized intersection approaches, as summarized in table 92.

Table 92. Summary of approach treatments.

Approach Treatment Type	Treatment
Traffic control	Mast arm and span wire mounts Near-side traffic signal heads Larger traffic signal heads Two red signal sections Increase number of signal heads Backplates Advanced warning flashers Dilemma zone protection Operating speed Prohibit U-turns
Pavement/cross section improvements	Skid resistance Rumble strips Improved cross section Removal of obstacles
Visibility	Improved sight distance

11.1 SIGNAL HEAD PLACEMENT AND VISIBILITY

Traffic signals should be placed so the signal heads are visible at a distance upstream of the intersection and from all lanes on the approach. Approaches with poorly placed traffic signals are likely to experience an increase of rear-end conflicts and collisions. At intersections with a higher proportion of heavy trucks, drivers in adjacent lanes or following a heavy vehicle may not be able to see the signal indication, which may lead to inadvertent red light running. Many red light runners claim they did not see the traffic signal, and often the reason is the poor placement of traffic signal heads or a failure to make the traffic signal head visually prominent.

Approach treatments that improve signal visibility will aid drivers in making decisions at the intersection and forewarn them of a signalized intersection. Subsequently, the probability of driver error, such as inadvertently running a red light and being involved in a collision, is lower.

The following sections identify traffic control treatments that can be applied to improve the visibility of signal heads.

11.1.1 Convert to Mast Arm or Span Wire Mounted Signal Heads

Description

Three major types of signal head placement are in popular use today: pedestal, span wire, or mast arm mounted. Merits and drawbacks of each were discussed in chapter 4. For a signalized intersection experiencing safety problems related to the placement or visibility of a pedestal-mounted signal head, the traffic engineer may wish to consider either replacing signal heads or supplementing signal heads on existing mast arms or span wire. Replacing or supplementing signal heads may be considered when:

- An approach where a pedestal-mounted traffic signal head is located against a backdrop with a considerable amount of visual clutter.
- An approach where heavy truck traffic habitually prevents adjacent and following drivers from viewing a pedestal-mounted traffic signal head.

Both mast arms and span wire mounted traffic signals improve the signal head's prominence upstream of the intersection.

Application

This treatment should be considered:

- At intersections where a high number of rear-end collisions occur.
- At intersections where a high number of angle collisions occur that may be attributable to inadvertent red light runners.

Safety Performance

The impact of mast arm mounted signal heads and all-red intervals on safety at six intersections was evaluated in Kansas City, MO. Results showed that upgrading to mast-mounted signals on wide streets and implementing an all-red interval are cost-effective improvements that reduce the number of collisions at intersections. The upgrade was found to be particularly effective for intersections with pedestal-mounted signals that experienced a larger number of right-angle collisions, resulting in an overall 25 percent reduction in collisions and a 63 percent reduction in right-angle collisions.⁽¹⁶⁵⁾

Safety benefits of signal upgrades from pedestal to mast arm are shown in table 93.

Table 93. Safety benefits associated with using mast arms: Selected findings.

Treatment	Finding
Replace pedestals with mast arms ⁽¹⁶⁶⁾	49% estimated reduction in all collisions. 44% estimated reduction in fatal/injury collisions. 51% estimated reduction in property-damage-only (PDO) collisions. 74% estimated reduction in right angle collisions. 41% estimated reduction in rear-end collisions. 12% estimated reduction in left-turn collisions.

Operational Performance

Signal head placement has a negligible effect on intersection capacity.

Multimodal Impacts

The placement of traffic signal heads on span wires or mast arms will be particularly advantageous for heavy vehicles, giving them additional time to decelerate and come to a full stop.

Physical Impacts

Span wire mounted signal heads have an advantage over mast arm mounted signal heads. At larger intersections, the length of the mast arm may limit its use.

Socioeconomic Impacts

Span wire installations are generally considered less aesthetically pleasing than mast arms because of overhead wires.

Enforcement, Education, and Maintenance

Span wire installations generally have higher maintenance costs than mast arms. Both types may need additional reinforcements if installed in a location known for strong winds.

Summary

Table 94 summarizes the issues associated with using mast arm or span wire mounts for signal heads.

Table 94. Summary of issues for using mast arm/span wire mounted signal heads.

Characteristic	Potential Benefits	Potential Liabilities
Safety	Increases signal visibility. Decreases angle collisions.	None identified.
Operations	Negligible effect.	None identified.
Multimodal	Heavy vehicles have more time to stop.	None identified.
Physical	Greater flexibility in placement of span wire poles.	Less flexibility in placement of mast arm poles.
Socioeconomic	None identified.	Span wires not aesthetically pleasing.
Enforcement, Education, and Maintenance	None identified.	Span wires typically require more maintenance than mast arms.

11.1.2 Add Near-Side Signal Heads

Description

Supplemental pole mounted traffic signals may also be placed on the near side of the intersection. This may be particularly useful if:

- Sight distance is an issue, such as on approaches to intersections on curves.
- The intersection is particularly wide, so that a far-side signal cannot be placed within MUTCD sight distance requirements for approaching drivers.⁽¹⁾

Applicability

Near-side pole placements may be considered where there may be limited sight distance or at a particularly wide intersection with a high number of rear-end or angle collisions. Refer to section 4D.15 of the MUTCD for guidance on the location of signal heads.⁽¹⁾

Safety Performance

Supplemental pole-mounted traffic signals appear to reduce the number of fatal and injury collisions at an intersection, according to the limited research that has been done on their effectiveness at preventing collisions.

Operational Performance

Additional signal poles, when placed on the near side of an intersection have a negligible effect on intersection capacity.

Multimodal Impacts

A near-side placement of a traffic signal on a median benefits heavy trucks by giving them additional warning.

The placement of the traffic signal should not interfere with the movement of pedestrians across the intersection or along the sidewalk.

Physical Impacts

As a pedestal traffic signal is mounted on the near side of an intersection, a median must be present in that location. Additional costs are likely required to provide electricity and conduit to connect to the traffic controller.

Summary

Table 95 summarizes the issues associated with supplemental near-side traffic signal poles.

Table 95. Summary of issues for supplemental near-side traffic signal heads.

Characteristic	Potential Benefits	Potential Liabilities
Safety	Increases signal visibility. Decreases angle collisions.	None identified.
Operations	Negligible.	None identified.
Multimodal	Heavy trucks have more time to stop.	May interfere with movement of crossing pedestrians.
Physical	None identified.	None identified.
Socioeconomic	None identified.	Moderate costs.
Enforcement, Education, and Maintenance	None identified.	None identified.

11.1.3 Increase Size of Signal Heads

Description

Two diameter sizes are currently in use for signal lenses: 200 mm (8 inches) and 300 mm (12 inches). Of these, 300-mm (12-inch) signal faces for red, amber, and green indications are commonly used at medium- and high-volume intersections. A goal many jurisdictions are working toward is to limit use of 200-mm (8-inch) signal heads to only low-speed locations without confusing/complex backgrounds. The MUTCD indicates 300-mm (12-inch) signal faces shall be used (section 4D.15):⁽¹⁾

- Where road users view both traffic control and lane-use control signal heads simultaneously.
- If the nearest signal face is between 35 m (120 ft) and 45 m (150 ft) beyond the stop line, unless a supplemental near-side signal face is provided.
- For signal faces located more than 45 m (150 ft) from the stop line.

- For approaches to all signalized locations for which the minimum sight distance cannot be obtained.
- For arrow signal indications.

Due to the large size and high speeds of many high-volume signalized intersections, the use of 300-mm (12-inch) signal faces is recommended as a general practice for these intersections.

Application

Using a 300-mm (12-inch) lens, in particular for the red indication, should improve visibility for the driver, and as such should reduce red light running and associated angle collisions.

Safety Performance

As part of a safety improvement program conducted in Winston-Salem, NC, 300-mm (12-inch) signal lenses were installed on at least one approach at 58 intersections. The result was a 47-percent drop in right angle collisions and a 10-percent drop in total collisions.⁽¹³⁵⁾ A before-and-after study was undertaken to assess the effectiveness of larger (300 mm (12 inches)) and brighter signal head displays in British Columbia. Results from an EB analysis showed the frequency of total crashes was reduced by approximately 24 percent with the proposed signal displays. The results were found to be consistent with previous studies and laboratory tests that showed increased signal visibility results in shorter reaction times by drivers and leads to improved safety.⁽¹⁶⁷⁾

References regarding the safety benefits of installing 300-mm (12-inch) signal lenses are shown in table 96.

Table 96. Safety benefits associated with using 300-mm (12-inch) signal lenses: Selected findings.

Treatment	Finding
Install 300-mm (12-inch) signal lenses, use higher wattage bulbs ⁽¹⁶⁷⁾	24% estimated reduction in all collisions.
Install 300-mm (12-inch) signal lenses ⁽¹³⁵⁾	47% estimated reduction in right angle collisions. 10% estimated reduction in all collisions.

Operational Performance

This treatment has a negligible effect on intersection capacity.

Socioeconomic Impacts

Using 300-mm (12-inch) lenses costs nominally more than 200-mm (8-inch) lenses.

Summary

Table 97 summarizes the issues associated with increasing the size of signal heads.

Table 97. Summary of issues for increasing the size of signal heads.

Characteristic	Potential Benefits	Potential Liabilities
Safety	Potential reduction in collisions.	None identified.
Operations	None identified.	None identified.
Multimodal	None identified.	None identified.
Physical	None identified.	None identified.
Socioeconomic	None identified.	Larger signal heads cost nominally more than smaller signal heads.
Enforcement, Education, and Maintenance	None identified.	None identified.

11.1.4 Use Two Red Signal Sections

Description

This treatment involves doubling the red signal indication on a signal head, which is permissible by the MUTCD (section 4D.16).⁽¹⁾ A possible arrangement is shown in figure 113.

Note that the use a double red lens in any face does not eliminate the need for a second signal head with at least 2.4 m (8 ft) of horizontal separation between the two heads (section 4D.15).⁽¹⁾



Figure 113. Signal head with a double red signal indication.

Application

This treatment should be considered in situations where an unusually high number of angle collisions occur involving a red light running vehicle.

Safety Performance

Two red signal sections in a single signal head will also increase the conspicuity of the red display and further increase the likelihood that the driver will see the signal. This improvement has had success in Winston-Salem, NC, where red “T” displays were associated with a drop in right-angle collisions (33 percent) and total collisions (12 percent).⁽¹³⁵⁾

Table 98. Safety benefits associated with using a double red indication (red “T”) display:
Selected findings.

Treatment	Finding
Red “T” display ⁽¹³⁵⁾	12% estimated reduction in all collisions. 33% estimated reduction in right-angle collisions.

Operational Performance

This treatment has a negligible effect on intersection capacity.

Socioeconomic Impacts

The additional cost of using two red signal sections is minimal.

Summary

Table 99 summarizes the issues associated with using two red signal sections.

Table 99. Summary of issues for using two red signal sections.

Characteristic	Potential Benefits	Potential Liabilities
Safety	Potential for reduction in collisions, especially rear-end collisions.	None identified.
Operations	Negligible impact.	None identified.
Multimodal	None identified.	None identified.
Physical	No physical impacts.	None identified.
Socioeconomic	None identified.	Minor cost.
Enforcement, Education, and Maintenance	None identified.	None identified.

11.1.5 Increase Number of Signal Heads

Description

The number of signal heads may be increased so one signal head is over each lane of traffic on an approach. Current MUTCD requirements for signal head placement state “a minimum of two signal faces shall be provided for the major movement on the approach, even if the major movement is a turning movement” (section 4D.15).⁽¹⁾ In addition, at least one signal head must be not less than 12 m (40 ft) beyond the stop line and not more than 55 m (180 ft) beyond the stop line unless a supplemental near-side signal face is provided. Finally, at least one and preferably both of the signal faces must be within the 20-degree cone of vision.

Placement of traffic signal heads on a mast arm above each lane is commonly used. Figure 114 shows an example of an approach with dual left-turn lanes, two through lanes, and a right-turn lane with lane-aligned signal heads.



Figure 114. Lane-aligned signal heads.

Application

This treatment should be considered in situations where an unusually high number of angle collisions occur because a vehicle runs a red light.

Safety Performance

Increasing the number of signal heads is expected to decrease the occurrence of red light running at an intersection in situations where driver fail to see a red signal. In one study in Winston-Salem, NC where such an improvement was undertaken, the addition of signal heads was associated with a decrease in right-angle collisions by 47 percent.⁽¹³⁵⁾ A Canadian study also found that adding a primary signal head decreased collisions of all severities; right-angle collisions dropped 15 to 45 percent.⁽¹⁶⁸⁾

However, the same Winston-Salem, NC study found that collisions increased overall by 15 percent.⁽¹³⁵⁾ This may be due to drivers' unfamiliarity with such a treatment; more rear-end collisions may have occurred due to sudden braking on the approach as the indication turns red.

Table 100 summarizes selected findings relating to the safety benefits of adding a signal head.

Table 100. Safety benefits associated with addition of a signal head: Selected findings.

Treatment	Finding
Add a signal head ⁽¹³⁵⁾	15% estimated increase in all collisions. 47% estimated reduction in right-angle collisions.
Add a primary signal head ⁽¹⁶⁸⁾	10 to 25% estimated reduction in fatal/injury collisions. 30 to 35% estimated reduction in PDO collisions. 15 to 45% estimated reduction in right-angle collisions. 0 to 45% estimated reduction in rear-end collisions.

Operational Performance

This treatment has a negligible effect on intersection capacity.

Socioeconomic Impacts

The capital cost of adding an extra signal head is minimal if the existing mounting and pole can be used. If a new mast arm and/or pole is required, for instance, the costs could be significant. Additional maintenance and electricity costs are incurred over time.

Summary

Table 101 summarizes the issues associated with adding a signal head.

Table 101. Summary of issues for adding a signal head.

Characteristic	Potential Benefits	Potential Liabilities
Safety	General reduction in collisions.	One study reported minor increase in collisions.
Operations	Negligible impact.	None identified.
Multimodal	None identified.	None identified.
Physical	None identified.	May require new signal pole and foundation.
Socioeconomic	None identified.	Costs may be high if a new mast arm and pole is required.
Enforcement, Education, and Maintenance	None identified.	None identified.

11.1.6 Provide Backplates

Description

Backplates are a common treatment for enhancing the visibility of a signal head. There are two main types of backplates:

- Those having a dull black finish, to enhance the contrast between the signal head and surrounding.
- Those with a strip of yellow retroreflective tape around the outside edge of the backplate (currently considered “experimental” by the MUTCD).⁽¹⁾

Applicability

Both types of backplates serve to increase the contrast between the signal head and its surroundings, drawing the attention of approaching drivers, therefore increasing the likelihood that they will stop on a red indication. Both should be used in situations where a high number of angle collisions occur.

The two different types of backplates are used in very different applications. Black backplates may be useful on east-west approaches where the sun often is low in the sky, or against bright or confusing backgrounds. Conversely, yellow retroreflective tape on a backplate may be helpful to improve conspicuity, particularly at night.

Operational Features

Backplates with a yellow retroreflective strip around the outside edge highlight the presence of the traffic signal. This is an advantage particularly during power outages.

Safety Performance

A study of black backplates in Winston-Salem, NC, found a 32-percent drop in right-angle collisions at intersections where backplates were installed.⁽¹³⁵⁾ A British Columbia study involving a comparison of collision frequency using the EB analysis before and after installation of backplates with a yellow retroreflective strip around the outside edge at a number of intersections concluded that they were effective at reducing the number of automobile insurance claims by 15 percent.⁽¹⁶⁹⁾

However, the Winston-Salem, NC study indicated that collisions appear to increase overall at intersections where black backplates were used.⁽¹³⁵⁾ The overall increase in collisions may be due to drivers' unfamiliarity with such a treatment, causing more rear-end collisions due to sudden braking on the approach as the indication turns red.

A summary of selected findings into the safety benefits of the use of backplates is shown in table 102.

Table 102. Safety benefits associated with the use of signal backplates: Selected findings.

Treatment	Finding
Backplates ⁽¹³⁵⁾	12% estimated increase in all collisions. 32% estimated reduction in right-angle collisions.

Operational Performance

This treatment has a negligible effect on intersection capacity.

Socioeconomic Impacts

The cost of installing signal backplates on a signal head is minimal. In addition, extra wind loading caused by backplates may necessitate larger (more costly) support poles for both span wires and mast arms.

Education/Enforcement/Maintenance

Due to their larger size, signal heads with backplates may be more prone to movement during high winds. This may pose a particular problem if they are mounted on a span wire, leading to maintenance issues.

Summary

Table 103 summarizes the issues associated with using signal head backplates.

Table 103. Summary of issues for using signal head backplates.

Characteristic	Potential Benefits	Potential Liabilities
Safety	General reduction in collisions.	One study reported minor increase in collisions.
Operations	Negligible impact.	None identified.
Multimodal	None identified.	None identified.
Physical	None identified.	None identified.
Socioeconomic	None identified.	Minor cost for backplates. Possible increased pole cost for increased wind loads.
Enforcement, Education, and Maintenance	None identified.	None identified.

11.1.7 Provide Advance Warning

Description

Two treatments used to provide advance warning to motorists are those that:

1. Provide a general warning of a signalized intersection ahead.
2. Provide a specific warning of an impending traffic signal change (from green to red) ahead.

Treatments that provide a general warning include static signs (SIGNAL AHEAD) and continuous advance-warning flashers. These flashers consist of a sign mounted on a pole with an amber flashing light. The sign may read BE PREPARED TO STOP or show a schematic of a traffic signal. This type of flasher flashes regardless of what is occurring at the signal. Both treatments are placed upstream of the traffic signal at a distance sufficient to allow drivers time to react to the signal.

The second type of treatment provides a specific warning of an impending traffic signal change ahead. These advance-warning flashers inform drivers of the status of a downstream signal. This type is activated showing yellow flashing lights or illuminating an otherwise blank changeable message such as "Red Signal Ahead" for several seconds.

The sign and the flashers are placed a certain distance from the stop line as determined by the speed limit on the approach.

Applicability

The SIGNAL AHEAD sign and advance warning flasher are recommended by the MUTCD in cases where the primary traffic control is not visible from a sufficient distance to permit the driver to respond to the signal. Advance warning flashers may be an effective countermeasure for:

- Rear-end collisions where a driver appears to have stopped suddenly to avoid running a red light and was struck from behind.
- Angle collisions caused by inadvertent red light running.
- Queues from a red signal occurring at a location where approaching traffic cannot see it due to a vertical or horizontal curve.

Advance-warning flashers are appropriate for high-speed, rural, isolated intersections where the signalized intersection may be unexpected or where there may be sight distance issues. They

appear to be most beneficial in situations where the minor approach volumes exceed 13,000 AADT or greater.⁽¹⁷⁰⁾

Operational Features

A key factor in operating an advance-warning flasher is determining an appropriate time for coordinating the onset of flash with the onset of the yellow interval at the traffic signal. The recommended practice is to time the onset of flash as a function of posted speed for the distance from the flasher to the stop bar. Timing the onset of flash for speeds greater than the posted speed encourages speeding to clear the intersection before the onset of the red interval.

Safety Performance

The introduction of advance-warning flashers on the approaches to a signalized intersection appears to be associated with a reduction in right-angle collisions.

Right-angle collisions were reduced by 44 percent at 11 signalized intersections in where a SIGNAL AHEAD sign was installed on one or more approaches.⁽¹³⁵⁾

A study conducted in Minnesota involving the installation of an advance-warning flasher on one approach found a 29 percent reduction in the number of red light running events, in particular those involving trucks (63 percent). The study did not use a control or comparison group of intersection approaches.⁽¹⁷¹⁾

Results from a study of 106 signalized intersections in British Columbia show that intersections with advance-warning flashers have a lower frequency of crashes than similar locations without flashers. The results were not statistically significant at the 95th-percent confidence level. Benefits were found primarily for moderate-to-high traffic volumes on the minor approach.⁽¹⁷⁰⁾

Table 104 shows selected references to safety benefits of advance-warning devices.

Table 104. Safety benefits associated with advance warning signs and flashers: Selected findings.

Treatment	Finding
Post SIGNAL AHEAD warning signs—urban ⁽⁹⁸⁾	16 to 35% estimated decrease in all collisions.
Post SIGNAL AHEAD warning signs—rural ⁽⁹⁸⁾	16 to 40% estimated decrease in all collisions.
Post SIGNAL AHEAD signs ⁽¹³⁵⁾	44% estimated decrease in right-angle collisions.
Advance-warning flasher ⁽¹⁷²⁾	44% estimated decrease in all fatal/injury collisions. 53% estimated decrease in PDO collisions. 73% estimated decrease in all fatal/injury-angle collisions. 67% estimated decrease in all fatal/injury left-turn collisions. 82% estimated increase in all rear-end fatal/injury collisions.

Operational Performance

Advance warning flashers have no documented effect on intersection capacity.

Multimodal Impacts

Flashers may be particularly useful for larger commercial vehicles, which need a greater distance to stop on intersection approaches.

Socioeconomic Impacts

Advance-warning flashers that activate before the onset of the yellow phase may be costly to install.

Enforcement, Education, and Maintenance

Another study investigated the effect of advance flashing amber signs at two intersection approaches. Results showed that only a few drivers responded to the start of flashing by slowing down. The majority of vehicles increased their speed; many significantly exceeded the speed limit. Fifty percent of drivers who saw the flashing amber within the first 3 seconds it was displayed continued through the stop line. Driver education and police enforcement should be applied to ensure that drivers respond appropriately to signal-activated advance warning flashers.⁽¹⁷³⁾

Summary

Table 105 summarizes the issues associated with advance warning treatments.

Table 105. Summary of issues related to advance warning treatments.

Characteristics	Potential Benefits	Potential Liabilities
Safety	Decreases angle collisions.	May induce some drivers to try to beat the light.
Operations	Negligible effect.	None identified.
Multimodal	Heavy vehicles given more time to stop.	None identified.
Physical	None identified.	Activated advance-warning flashers require link to traffic controller at intersection.
Socioeconomic	Signage and continuous advance-warning flashers have low cost.	Activated advance-warning flashers have significant costs.
Enforcement, Education, and Maintenance	None identified.	Enforcement may be needed to ensure compliance with the signal indications.

11.2 SIGNING AND SPEED CONTROL TREATMENTS

11.2.1 Improve Signing

Description

For some intersections, the use of signs beyond the minimum required by the MUTCD may be beneficial in improving either safety or operations.⁽¹⁾

Application

Signing treatments to consider at signalized intersections include:

- Increase the size of signs. Signs located on wide streets are more difficult to read from the far lane. Likewise, signs located overhead on mast arms appear smaller to drivers and therefore need to be substantially larger than ground-mounted signs to have the same target visibility.⁽⁶²⁾
- Use overhead lane-use signs. These provide improved visibility and may help correct a problem with sideswipe crashes on approach due to last-minute lane changes. These are especially important for treatments involving indirect turning movements

that may violate driver expectation. In addition, ground-mounted signs may be less visible in a typical urban environment due to visual clutter.

- Use large street name signs on mast arms. These signs, either retroreflective or internally illuminated, are visible from a greater distance.
- Use advance street name signs that include the legend NEXT SIGNAL.

Safety Performance

No studies are available to document specific benefits of the use of advance signing. Advance lane-use signs may improve safety by reducing last-minute lane changes.

Selected findings of safety benefits of other types of improved signage at signalized intersections are shown in table 106.

Table 106. Safety benefits associated with sign treatments: Selected findings.

Treatment	Finding
Install larger signs ⁽⁹⁸⁾	15% decrease in all collisions.
Overhead lane-use signs ⁽¹⁷⁴⁾	10% decrease in rear-end collisions. 20% decrease in sideswipe collisions.

Operational Performance

Advance lane use signing may improve lane utilization at the intersection and therefore improve capacity, if the affected movement is critical.

Physical Impacts

Sign supports are obstacles that could injure bicyclists, motorcyclists, pedestrians, and drivers.⁽⁶²⁾ Therefore, each sign should be carefully located to minimize the potential hazard. In addition, large advance signs can be difficult to locate in areas with tight right-of-way or where a sidewalk would be adversely affected by the sign or its support.

Socioeconomic Impacts

Advance signs, particularly if they are mounted overhead on a mast arm or sign bridge, can significantly add to the cost of the intersection.

Summary

Table 107 summarizes the issues associated with improving signing.

Table 107. Summary of issues for improving signing.

Characteristic	Potential Benefits	Potential Liabilities
Safety	Larger signs or overhead lane-use signs may reduce collisions.	None identified.
Operations	Advance signing may improve lane utilization and capacity of the intersection.	None identified.
Multimodal	None identified.	None identified.
Physical	None identified.	Sign supports must be designed to minimize potential hazard.
Socioeconomic	None identified.	Advance signs mounted overhead may add significantly to the cost of the intersection.
Enforcement, Education, and Maintenance	None identified.	None identified.

11.2.2 Reduce Operating Speed

Excessive speed on an approach may lead to drivers' running a red light, braking suddenly to avoid a signal change, or losing control of the vehicle while attempting a left or right turn. Reducing the operating speed on an intersection approach cannot be accomplished through simply lowering the posted speed limit. Research suggests that drivers use the road and the surrounding road environment in choosing the operating speed of their vehicle, as opposed to a posted speed limit.

Possible countermeasures that may reduce the operating speed of vehicles are landscaping, rumble strips, medians, narrow travel lanes, bike lanes, on-street parking, and curb radii reductions. Several of these treatments are discussed elsewhere in the guide; the reader is encouraged to refer to those sections for more information.

11.3 ROADWAY SURFACE IMPROVEMENTS

11.3.1 Improve Pavement Surface

Description

An important objective of highway design is ensuring that pavement is skid resistant and provides for adequate drainage. A polished pavement surface, a surface with drainage problems, or a poorly maintained road surface can contribute to crashes at or within intersections. Within an intersection, the potential for vehicles on adjacent approaches to be involved in crashes contributes to the likelihood of severe (angle) crashes, particularly in crashes where the driver is unable to stop in time.

Water can accumulate on pavement surfaces due to rutted wheel paths, inadequate crown, and poor shoulder maintenance. These problems can also cause skidding crashes and should be treated when present. While there is only limited research on such site-specific programs, the results provide confidence that pavement improvements are effective in decreasing crashes related to wet pavement. The effectiveness will vary with respect to location, traffic volume, rainfall intensity, road geometry, temperature, pavement structure, and other factors

Vehicles often experience difficulties in coming to a safe stop at intersections because of reduced friction on wet or slippery pavement. A vehicle will skid during braking and maneuvering when frictional demand exceeds the friction force that can be developed between the tire and the

road surface; friction is greatly reduced on a wet and slippery surface, which has 20 to 30 percent less friction than a dry road surface.⁽¹⁷⁵⁾

Water pooling on or flowing across the roadway can prevent smooth operation of an intersection if vehicles are forced to decelerate or swerve in order to proceed safely through the intersection. It is necessary to intercept concentrated storm water at all intersection locations before it reaches the highway and to remove over-the-curb flow and surface water without interrupting traffic flow or causing a problem for vehicle occupants, pedestrians, or bicyclists. Improvements to storm drainage may be needed to improve intersection operations and safety. Potholes, if present on an approach, increase the likelihood of drivers' swerving or braking to avoid damage to their vehicles. A rough surface may also allow water to pool, and in colder environments, can cause black ice to form on an intersection approach.

Proper drainage and a high-quality surface will prevent problems related to pooled water and lack of skid resistance. Skid resistance is an important consideration in pavement design, and polished pavement surfaces should be addressed to reduce the potential for skidding. Both vehicle speeds and pavement condition affect the surface's skid resistance. Improving the pavement condition, especially for wet weather conditions, can be accomplished by providing adequate drainage, grooving existing pavement, or overlaying existing pavement.

Improvements to pavement condition should have high initial skid resistance, ability to retain skid resistance with time and traffic, and minimum decrease in skid resistance with increasing speed.

Applicability

Improvements related to skid resistance, drainage problems, and pavement surface should be considered when:

- A high number of wet road surface collisions occur.
- Angle collisions occur and many involve one or more vehicles' skidding into the intersection and striking another vehicle.
- Single-vehicle collisions occur where the driver lost control due to skidding.
- Rear-end or sideswipe collisions occur when drivers swerve or brake to avoid potholes or puddles.

Safety Performance

Several pavement treatments appear to reduce the number of skidding collisions. An early 1974 before-and-after study showed an 85 percent drop in wet pavement collisions after longitudinal grooving was applied to pavement.⁽¹⁷⁶⁾ Grooves carry off water from the road surface and increase the coefficient of friction between tires and pavement. Another more contemporary paper describes a noncarbonate surface treatment used at a wide range of sites as part of a comprehensive Skid Accident Reduction Program. Wet pavement collisions dropped by 61 to 82 percent; fatal and injury wet pavement collisions dropped by 73 to 84 percent.⁽¹⁷⁷⁾ It should be noted the collision reduction described in both studies includes both road segments and intersections.

Apart from addressing wet road surface collisions, resurfacing the approaches to an intersection will likely reduce the number of rear-end or sideswipe collisions caused when vehicles swerve or slow to avoid potholes. It may, however, lead to a higher operating speed and an overall shift in the collision profile toward collisions of greater severity.

References to safety benefits associated with nonskid treatments, drainage improvements or resurfacing are shown in table 108.

Table 108. Safety benefits associated with nonskid treatments, drainage improvements, or resurfacing: Selected findings.

Treatment	Finding
Groove pavement ⁽¹³²⁾	25% estimated reduction in all collisions. 60% estimated reduction in wet pavement collisions.
Overlay pavement ⁽¹⁷⁸⁾	27% estimated reduction in all collisions. 29% estimated reduction in fatal collisions. 16% estimated reduction in injury collisions. 32% estimated reduction in PDO collisions.
Resurfacing ⁽¹³²⁾	25% estimated reduction in all collisions. 45% estimated reduction in wet pavement collisions.
Improve pavement texture ⁽¹⁷⁹⁾	5% estimated reduction in all collisions.
Noncarbonate surface treatment ⁽¹⁷⁷⁾	61 to 82% estimated reduction in wet pavement collisions. 73 to 82% estimated reduction in fatal/injury collisions on wet pavement.
Drainage improvement ⁽⁹⁸⁾	20% estimated reduction in all collisions.

Operational Performance

A pavement in poor condition can result in lower saturation flow rates and, consequently, reduce the capacity of the intersection. If vehicles need to proceed at slow speeds through an intersection or deviate from the travel path to avoid potholes, pooled water, or ice, operations likely will degrade.

Pavement resurfacing and drainage improvements usually improve intersection operations, although no known research conclusively indicates the expected capacity benefit of these treatments.

Multimodal Impacts

If road improvements are being carried out, sidewalks and bike paths adjacent to the intersection should be considered for skid-resistant treatments, checked for adequate drainage, and repaired if uneven surfaces exist due to cracking, frost heaves, etc. This will reduce pedestrian tripping hazards and the likelihood of bicyclists' swerving into traffic to avoid potential roadside hazards.

Enforcement, Education, and Maintenance

Pavement improvements (particularly resurfacing) may convey the message to drivers that they can now travel at higher speeds. Speeds on the approaches to the intersection should be monitored to ensure that the speed profile has not increased significantly in the post-implementation period. If speed has increased significantly and this is leading to degradation in safety, police speed enforcement should be considered.

Summary

Table 109 summarizes the issues associated with pavement treatments.

Table 109. Summary of issues for pavement treatments.

Characteristic	Potential Benefits	Potential Liabilities
Safety	Wet-weather collisions reduced. Angle collisions due to skidding reduced. Rear-end/sideswipe collisions due to swerving/braking reduced.	Higher speed profile a possible byproduct.
Operations	Improved traffic flow, less swerving.	None identified.
Multimodal	None identified.	Adjacent sidewalks should be considered as well.
Physical	No additional requirements.	None identified.
Socioeconomic	Relatively low costs associated with improvements.	None identified.
Enforcement, Education, and Maintenance	None identified.	Enforcement may be needed to control speeds.

11.3.2 Provide Rumble Strips

Description

Rumble strips are warning devices that can be used to alert drivers to the presence of a traffic signal, thereby reducing the likelihood that the motorist will run a red light. They can also help reduce speeds on approaches. Rumble strips are a series of intermittent, narrow, transverse areas of rough-textured, slightly raised or depressed road surfaces. Rumble strips provide an audible and vibro-tactile warning to the driver. They are often used in conjunction with pavement markings.

Application

Rumble strips may be considered in rural areas, on approaches to signalized intersections where the traffic signal is not visible from a distance, and in situations where a high number of angle collisions occur. They generally result in too much noise in urban areas.

Safety Performance

Rumble strips may reduce the likelihood of a right angle collision by alerting the driver to the traffic signal. References to safety benefits associated with rumble strips are shown in table 110.

Table 110. Safety benefits associated with rumble strips: Selected findings.

Treatment	Finding
Rumble strips ⁽¹³²⁾	25% estimated reduction in all collisions.

Operational Performance

This treatment will increase the time headway between vehicles at an intersection, thus decreasing the capacity of the intersection and increasing delays and queuing. This will not be an issue if the application is for a high-speed rural intersection with lower volumes. However, the treatment may not be applicable to an urban intersection already experiencing congestion.

Multimodal Impacts

Rumble strips should not extend all of the way to the paved shoulder, because they would affect the safety of bicyclists traveling there.

Socioeconomic Impacts

Rumble strips may not be appropriate in residential areas due to the noise generated by vehicles traveling over them.

Summary

Table 111 summarizes the issues associated with rumble strips.

Table 111. Summary of issues for rumble strips.

Characteristics	Potential Benefits	Potential Liabilities
Safety	Angle collisions associated with inadvertent red light running should be reduced.	None identified.
Operations	None identified.	May not be desirable at intersections with a lower level of service
Multimodal	None identified.	May negatively impact bicyclists.
Physical	No physical requirements.	None identified.
Socioeconomic	None identified.	May not appropriate for residential areas.
Enforcement, Education, and Maintenance	None identified.	None identified.

11.3.3 Improve Cross Section

Description

Roadways should intersect on as flat a grade as possible to prevent difficulty in vehicle handling, especially when vehicles will likely need to wait for their turn to enter the intersection (as with left-turn lanes). However, it is not always feasible to design a level intersection, so consideration should be given to the profiles of the roadways as they intersect. The profiles and crowns of the roadways should be examined to determine whether the intersection of these slopes contributes to vehicle handling difficulties. Generally, the pavement of the minor road is warped so that the crown is tilted to the same plane as the major road profile. Another option is to flatten the cross sections of both roadways so that they are each inclined to intersect with the profile of the other road. This method can create a large pavement area, which in turn can lead to drainage problems; therefore, this design should only be used on smaller intersections or where the drainage problem can be solved. A third option involves maintaining constant cross sections on both roadways, and altering the centerline profiles to provide smooth pavement. This is a less desirable option than the previous two discussed, given that drivers from both directions must pass over three grade breaks at the intersection.⁽³⁾

In addition to the benefits to vehicles, pedestrians and bicyclists benefit from improvements to the cross section of an intersection. Severe grades and cross slopes can be difficult for bicyclists and pedestrians to negotiate. For example, flatter uphill grades allow bicyclists to more easily accelerate from a complete stop. Low cross slopes of no more than 2 percent are essential for pedestrians with mobility impairments per ADAAG, as severe cross slopes can make a roadway inaccessible.⁽³³⁾

Application

This treatment may be applicable at intersections where the grades of intersecting roads are greater than 3 percent and one or both of the following is true:

- A high number of rear-end collisions are occurring due to driver hesitation on the approaches and while making left or right turns.
- A high number of left-turn collisions are occurring due to poor sight distance.

Safety Performance

Cross section improvements discussed above will improve sight distance, and therefore should decrease left-turn conflicts with through vehicles. It will also allow a more uniform operating speed through the intersection on the major road approaches, reducing rear-end conflicts.

Operational Performance

Cross section improvements discussed above may reduce the time headway between vehicles and increase the capacity of the intersection.

Multimodal Impacts

Larger commercial vehicles and transit buses will particularly benefit from cross section improvements to the intersection. If the intersection is being reconstructed, the engineer must include improvements to the adjacent sidewalks if pedestrian facilities exist and are being used.

Social-economic impacts

Cross section improvements may have moderate costs. They may be difficult to implement in areas where there is little or no right-of-way. Coordination with adjacent landowners may be needed.

Education/Enforcement/Maintenance

Cross section improvements may convey the message that drivers can now travel at higher speeds. Speeds on the approaches to the intersection should be monitored to ensure that the speed profile has not increased significantly in the post-implementation period. If speed has increased significantly and this is leading to degradation in safety, police speed enforcement may be considered. Note that cross section improvements on hilly roadways may actually result in a reduction in speeds.

The effectiveness of this treatment will likely be enhanced if performed in conjunction with a comprehensive and timely winter road maintenance program in colder climates.

Summary

Table 112 summarizes the issues associated with cross section improvements.

Table 112. Summary of issues for cross section improvements.

Characteristic	Potential Benefits	Potential Liabilities
Safety	Decrease in rear-end collisions due to driver braking. Decrease in left-and right-turning collisions involving inadequate sight distance.	Higher speed profile.
Operations	Better traffic flow.	None identified.
Multimodal	Improved driver handling of large trucks and transit. Sidewalks and curb ramps will be made more accessible by retrofitting to new cross section.	None identified.
Physical	None identified.	Significant right-of-way requirements.
Socioeconomic	None identified.	Moderate costs.
Enforcement, Education, and Maintenance	None identified.	Speed enforcement may be necessary. Winter maintenance may be needed.

11.3.4 Remove Obstacles from Clear Zone

Description

Roadside objects can be a particular hazard to motorists on high-speed approaches. Utility poles, luminaires, traffic signal poles, bus shelters, signs, and other street furniture should be moved back from the edge of the road if possible and feasible. In general, a signalized intersection and the entire area within the right-of-way should be kept free of visual clutter, particularly illegally placed commercial signs.

Application

Obstacles should be routinely removed from the clear zone on intersection approaches. Removing objects should be considered an immediate priority when:

- There is an unusually high number of run-off-the-road injury and fatal collisions involving roadside obstacles.
- There is evidence in the collision police report that drivers claim distraction by unnecessary or illegally placed signage or other visual clutter.

Safety Performance

This treatment should decrease the frequency of run-off-the-road injury and fatal collisions involving roadside obstacles. The number of collisions involving distracted drivers (such as rear-end collisions) should also decrease.

Physical Impacts

Moving objects further away from the roadside may be difficult to implement in built-up areas where right-of-way is limited.

Enforcement, Education, and Maintenance

Traffic engineers should coordinate with their equivalents in the planning department and maintenance staff to ensure that the entire right-of-way surrounding the intersection and its approaches stays free of obstacles and extraneous signage.

Summary

Table 113 summarizes the issues associated with removing obstacles from the clear zone.

Table 113. Summary of issues for removing obstacles from the clear zone.

Characteristic	Potential Benefits	Potential Liabilities
Safety	Potential reduction in single-vehicle collisions.	None identified.
Operations	None identified.	None identified.
Multimodal	None identified.	None identified.
Physical		Obstacle removal may be difficult in built-up areas with limited right-of-way.
Socioeconomic	None identified.	None identified.
Enforcement, Education, and Maintenance		Ongoing maintenance will be needed to ensure that the clear zone remains free of obstacles.

11.4 SIGHT DISTANCE TREATMENTS

11.4.1 Improve Sight Lines

Description

Adequate sight distance for drivers contributes to the safety of the intersection. In general, sight distance is needed for left-turning vehicles to see opposing through vehicles approaching the intersection in situations where a permissive left-turn signal is being used. Also, where right turns on red are permitted, right-turning vehicles need adequate sight distance to view vehicles approaching from the left on the cross street, as well as opposing vehicles turning left onto the cross street. AASHTO's *A Policy on Geometric Design of Highways and Streets* recommends providing adequate sight distance for all movements at signalized intersections where the signal operates on flash at times.⁽³⁾

Figure 115 shows sight distance triangles in each direction for drivers on the minor approach to an intersection.

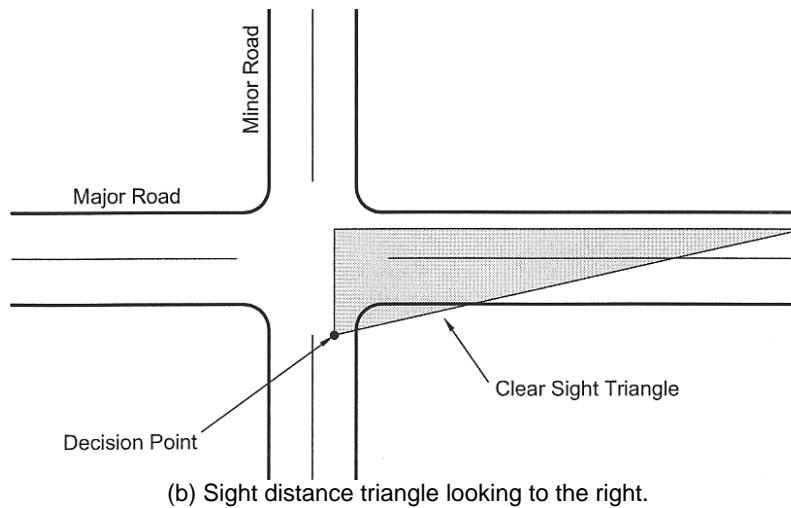
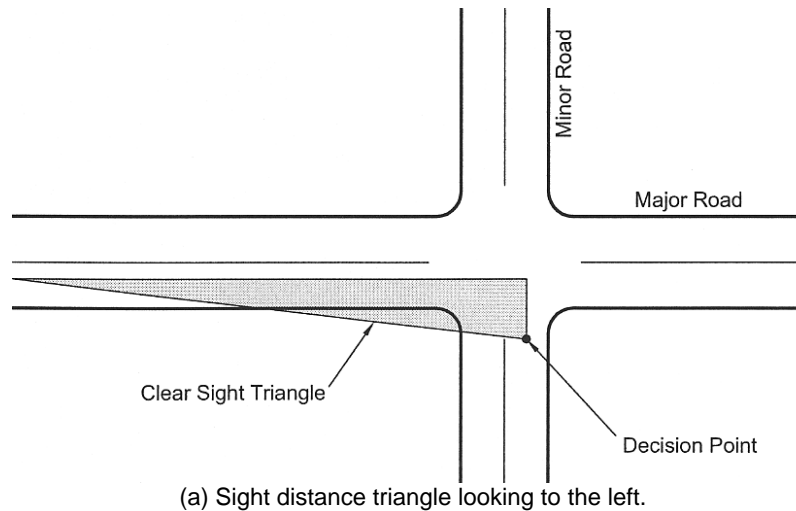


Figure 115. Illustration of sight distance triangles.⁽³⁾

Landscaping also must be carefully considered at signalized intersections, otherwise it will prevent motorists from making left and right turns safely due to inadequate sight distances. Care should be taken to ensure that traffic signs, pedestrian crossings, and nearby railroad crossing and school zones are not obstructed. Median planting of trees or shrubs greater than 0.6 m (2 ft) in height should be well away from the intersection (more than 15 m (50 ft)). No plantings having foliage between 0.6 m (2 ft) and 2.4 m (8 ft) in height should be present within sight triangles. Low shrubs or plants not exceeding a height of 0.6 m (2 ft) are appropriate on the approaches to a signalized intersection, either on the median, or along the edge of the roadway. The 1990 FHWA Guide, *Vegetation Control for Safety: A Guide for Street and Highway Maintenance Personnel*, provides additional guidelines and insight on vegetation control with regard to sight distance issues.⁽⁸⁴⁾

Application

Visibility improvements at a signalized intersections should be considered when:

- Inadequate sight distance exists between vehicles and/or pedestrians due to vegetation and other obstacles within sight triangles.

- A high number of left- and right-turn collisions are occurring.

Safety Performance

It is expected that crashes related to inadequate sight distance (specifically, angle- and turning-related) would be reduced if sight distance problems were improved. Intersections with sight distance problems will experience higher collision rates.⁽¹⁶⁷⁾ Older drivers are likely to have problems at intersections with limited sight distances, as they may need more time to perceive and react to hazards. Table 114 shows the expected reduction in number of collisions per intersection per year, based on an FHWA report.⁽¹⁸⁰⁾

Table 114. Expected reduction in number of crashes per intersection per year by increased sight distance.⁽¹⁸⁰⁾

AADT* (1000s)	Increased Sight Distance		
	6 m–15 m (20 ft–49 ft)	15 m–30 m (50 ft–99 ft)	> 30 m (> 100 ft)
< 5	0.18	0.20	0.30
5-10	1.00	1.30	1.40
10-15	0.87	2.26	3.46
> 15	5.25	7.41	11.26

* Annual average daily traffic entering the intersection

A more recent FHWA report cites sight distance improvements as being one of the most cost-effective treatments (see table 115). Fatal collisions were reduced by 56 percent and nonfatal injury collisions were reduced by 37 percent at intersections having sight distance improvements.⁽¹⁸¹⁾

Table 115. Safety benefits associated with sight distance improvements: Selected findings.

Treatment	Implication
Sight distance improvements ⁽¹⁸¹⁾	56% estimated reduction in fatal collisions. 37% estimated reduction in injury collisions.

Socioeconomic Impacts

Sight distance improvements can often be achieved at relatively low cost by clearing sight triangles of vegetation or roadside appurtenances.

The most difficult aspect of this strategy is the removal of sight restrictions located on private property. The legal authority of highway agencies to deal with such sight obstructions varies widely, and the time (and possibly the cost) to implement sight distance improvements by clearing obstructions may be longer if those obstructions are located on private property than if they are on public property. If the object is mature trees or plantings, then environmental issues may arise. Larger constructed objects (i.e., bus shelters, buildings) may not be feasibly removed. In these situations, other alternatives should be considered.

Multimodal Impacts

The appropriate use of landscaping can visually enhance a road and its surroundings. Landscaping may act as a buffer between pedestrians and motorists, and reduce the visual width of a roadway, serving to reduce traffic speeds while providing a more pleasant environment. However, landscaping should not interfere with the movement of pedestrians along sidewalks, nor should it block the motorist's view of the pedestrian, or the pedestrian's view of the motorist.

Enforcement, Education, and Maintenance

All plantings should have an adequate watering and drainage system, or should be drought resistant. This will minimize the amount of maintenance required and reduce the exposure of maintenance staff to traffic. Plantings should not be allowed to obstruct pedestrians at eye height or overhang the curb onto the pavement.

Summary

Table 116 summarizes the issues associated with visibility treatments.

Table 116. Summary of issues for visibility improvements.

Characteristics	Potential Benefits	Potential Liabilities
Safety	Left- and right-turning collisions involving inadequate sight distance.	None identified.
Operations	Negligible.	None identified.
Multimodal	Provides additional warning for heavy vehicles making left and right turns. Appropriate landscaping will provide a more pleasant environment for pedestrians.	None identified.
Physical	None identified.	May be significant right-of-way requirements.
Socioeconomic	Appropriate landscaping will visually enhance intersection and surroundings.	None identified.
Enforcement, Education, and Maintenance	None identified.	Landscaping may require extensive maintenance.

CHAPTER 12

INDIVIDUAL MOVEMENT TREATMENTS

TABLE OF CONTENTS

12.0	INDIVIDUAL MOVEMENT TREATMENTS	307
12.1	Left-Turn Treatments	307
12.1.1	Add Single Left-Turn Lane	307
12.1.2	Multiple Left-Turn Lanes	318
12.1.3	Turn Prohibition	322
12.2	Through Lane Treatments	324
12.2.1	Provide Auxiliary Through Lanes	324
12.2.2	Delineate Through Path	326
12.3	Right-Turn Treatments	328
12.3.1	Add Single Right-Turn Lane	328
12.3.2	Provide Double Right-Turn Lanes	333
12.3.3	Provide Channelized Right-Turn Lane	334
12.4	Variable Lane Use Treatments	336
12.4.1	Provide Reversible Lanes	336
12.4.2	Provide Variable Lane Use Assignments	338

LIST OF FIGURES

<u>Figure</u>		<u>Page</u>
116	Diagram of a single left-turn lane	308
117	Narrow (2.4-m (8-ft) left-turn lanes may be used effectively in retrofit situations	311
118	Example of positive offset	312
119	Intersection with turn paths delineated for dual left-turn lanes in Tucson, AZ (Kolb Road/ 22nd Street), June 1998	321
120	Diagram of an auxiliary through lane	324
121	Example of delineated paths	327
122	Diagram of a typical right-turn lane	328
123	Narrow (2.4-m (8-ft) right-turn lanes may be used effectively in retrofit situations	330
124	Example illustration of a channelized right-turn lane	334
125	Example use of variable lane use sign to add a third left-turn lane during certain times of day	339
126	Example use of variable lane use sign to add a second right-turn lane along a corridor during certain times of day	339

LIST OF TABLES

<u>Table</u>		<u>Page</u>
117	Rule-of-thumb intersection capacities assuming various exclusive left-turn treatments	309
118	Guidelines for use of left-turn phasing	313
119	Guidelines for selection of type of left-turn phasing	314
120	Minimum recommended sight distance for allowing permissive left turns	315
121	Safety benefits associated with left-turn lane design improvements: Selected findings	316
122	Summary of issues for left-turn lanes	317
123	Safety benefits associated with multiple left-turn lanes: Selected findings	319
124	Summary of issues for multiple left-turn lanes	322
125	Safety benefits associated with left-turn operational treatments: Selected findings	323
126	Summary of issues for turn prohibitions	324
127	Summary of issues for auxiliary through lanes	326

CHAPTER 12 TABLES, CONTINUED

<u>Table</u>	<u>Page</u>
128 Summary of issues for path delineation	327
129 Right-turn lane volume warrants.....	329
130 Safety benefits associated with right-turn improvements: Selected findings	331
131 Summary of issues for right-turn lanes	332
132 Summary of issues for double right-turn lanes	334
133 Safety benefits associated with right-turn channelization: Selected findings	335
134 Summary of issues for channelized right-turn lanes.....	336
135 Summary of issues for reversible lanes.....	338
136 Summary of issues for variable lane use.....	340

12. INDIVIDUAL MOVEMENT TREATMENTS

This section identifies treatments for vehicle movements at signalized intersections: left- and U-turn movements, through movements, and right-turn movements. In addition, this section addresses the use of variable lane use. The treatments in this section primarily address the following safety and operational deficiencies:

- An overrepresentation of rear-end collisions under congested conditions.
- An overrepresentation of collisions involving left-turning vehicles.
- An overrepresentation of bicycle and/or pedestrian crashes.
- Excessive queuing and/or delay for one (or more) approach movements.

12.1 LEFT-TURN TREATMENTS

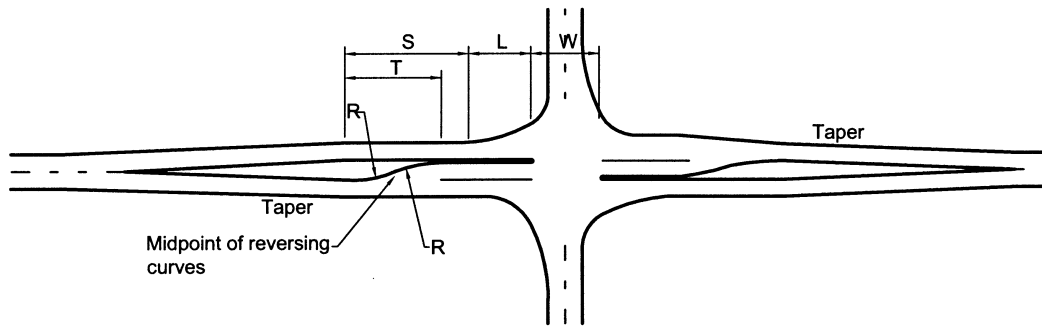
This section discusses the key safety, operational, and design characteristics associated with left-turn treatments, including the addition of a single left-turn lane, multiple left-turn lanes, and left-turn prohibition.

Left-turning vehicles encounter safety problems from several sources of conflict: pedestrians; bicyclists; opposing through traffic; through traffic in the same direction; and crossing traffic. These conflict types often lead to angle, sideswipe same direction, and rear-end crashes. Left-turn-related crashes typically account for a high percentage of total crashes at an intersection.

The demand for a left-turn movement also affects the amount of green time that can be allocated to additional movements. Operational treatments may be justified to minimize the amount of green time that is allocated to left-turn movements to serve additional critical movements at an intersection.

12.1.1 Add Single Left-Turn Lane

Adding a single left-turn lane at an approach that currently has shared through and left-turn movements is applicable when the delay caused to through vehicles adversely affects the operations and/or safety of an approach. An example is shown in figure 116. A disproportionately high amount of rear-end crashes involving left-turning vehicles followed by through vehicles is an indication that a left-turn lane may be appropriate. Physically separating turning vehicles from the through stream removes slow or decelerating vehicles from through traffic, thus reducing the potential for rear-end collisions. Left-turn lanes also increase the capacity of the approach by adding an additional approach lane; they allow for a wider variety of phasing options. On the other hand, depending on how the left-turn lane is added, the left-turn lane may add distance, time, and exposure for pedestrians and may increase the overall intersection cycle length, adding delay to all users.



- L = Storage length
- R = Radius of reversing curve
- S = Stopping sight distance for a speed of $(0.7)(\text{design speed of highway})$
- T = Tangent distance required to accommodate reversing curve
- W = Minimum distance of 12 m (40 ft)

Figure 116. Diagram of a single left-turn lane. ⁽¹⁸²⁾

Applicability

The adopted guidelines and practices of local agencies should be reviewed to determine whether left-turn lane warrants are in place for a particular roadway. Key elements that should be considered when determining whether a left-turn lane is warranted include:

- **Functional classification.** A left-turn lane should be considered for higher class facilities (i.e., arterials and principal arterials) for consistency (if other similar class facilities have left-turn lanes) and to accommodate an expected growth in traffic volumes.
- **Prevailing approach speeds.** An increase in speed differentials between through and slower-speed left-turning vehicles may lead to an increase in rear-end collisions.
- **Capacity of an intersection.** The addition of a left-turn lane increases the number of vehicles the intersection can serve.
- **Proportion of approach vehicles turning left.** Higher volumes of left-turn traffic result in increased conflicts and delay to through vehicles.
- **Volumes of opposing through vehicles.** High volumes of opposing vehicles reduce the number of gaps available for a left-turn movement (assuming permissive phasing), thus increasing conflicts and delay with approaching through movements.
- **Design conditions.** A left-turn lane may be needed to improve sight distance.
- **Crash history associated with turning vehicles.** A left-turn lane should be considered if there is a disproportionate amount of collisions involving left-turning vehicles on the approach.

In the absence of site-specific data, the *HCM 2000* indicates the probable need for a left-turn lane if the left-turn volume is greater than 100 vehicles in a peak hour, and the probable need for dual left-turn lanes if the volume exceeds 300 vehicles per hour.⁽²⁾ The HCM also indicates a left-turn lane should be provided if a left-turn phase is warranted.

Table 117 highlights several rule-of-thumb intersection capacities for various scenarios where exclusive left-turn treatments may be required on one or both approaches to an intersection. In general, exclusive left-turn lanes are needed when a left-turn volume is greater than 20 percent of

total approach volume or when a left-turn volume is greater than 100 vehicles per hour in peak periods.⁽⁴¹⁾

Table 117. Rule-of-thumb intersection capacities assuming various exclusive left-turn treatments.

Case I: No Exclusive Left-Turn Lanes				
Assumed critical signal phases*		2		
Left-turn volumes		Critical major approach:** ≤ 125 veh/hr Critical minor approach: ≤ 100 veh/hr		
Planning-level capacity (veh/hr), sum of critical approach volumes***		Number of basic lanes,**** major approach		
		2	3	4
Number of basic lanes, minor approach	1	1,700	2,300	—
	2	2,400	3,000	—
	3	—	—	—

Case II: Exclusive Left-Turn Lane on Major Approaches Only				
Assumed critical signal phases		3		
Left-turn volumes		Critical major approach: 150-350 veh/hr Critical minor approach: ≤ 125 veh/hr		
Planning-level capacity (veh/hr), sum of critical approach volumes		Number of basic lanes, major approach		
		2	3	4
Number of basic lanes, minor approach	1	1,600	2,100	2,300
	2	2,100	2,600	2,800
	3	2,700	3,000	3,200

Case III: Exclusive Left-Turn Lane on Both Major and Minor Approaches				
Assumed critical signal phases		4		
Left-turn volumes		Critical major approach: 150-350 veh/hr Critical minor approach: 150-250 veh/hr		
Planning-level capacity (veh/hr), sum of critical approach volumes		Number of basic lanes, major approach		
		2	3	4
Number of basic lanes, minor approach	1	1,500	1,800	2,000
	2	1,900	2,100	2,400
	3	2,200	2,300	2,800

Notes: *Critical signal phases are nonconcurrent phases
 **A critical approach is the higher of two opposing approaches (assumes same number of lanes)
 ***Use fraction of capacity for design purposes (e.g., 85 or 90 percent)
 ****Basic lanes are through lanes, exclusive of turning lanes
 Adapted from NCHRP 279, figure 4-11⁽⁴¹⁾

Key Design Features

Key design elements of an exclusive left-turn lane include: entering taper, storage length, lane width, and offset. Design criteria for left-turn lanes are presented in the AASHTO *A Policy on Geometric Design for Highways and Streets* as well as in the policies of individual highway agencies.⁽³⁾

Entering taper. Entering tapers should be designed to: (1) allow vehicles to depart the through travel lane with minimum braking; and (2) provide adequate length to decelerate and join the back of queue. An appropriate combination of deceleration and taper length will vary according to the situation at individual intersections. A relatively short taper and a longer deceleration length may be applicable at busier intersections where speeds are slower during peak hours. This allows more storage space during peak hours and reduces the potential for spillover into the adjacent through lane. However, off-peak conditions should be considered when vehicle speeds may be higher, thus requiring a longer deceleration length.

AASHTO indicates a taper rate of 8:1 to 15:1 is common for high-speed roadways. Using a taper that is too short may require a vehicle to stop suddenly, thus increasing the potential for rear-end collisions. Using a taper that is too long may result in drivers' inadvertently drifting into the left-turn lane, especially if located within a horizontal curve. AASHTO indicates that municipalities and urban counties are increasingly adopting the use of taper lengths such as 30 m (100 ft) for a single-turn lane.⁽³⁾

Storage length. The length of the left-turn bay should be sufficiently long to store the number of vehicles likely to accumulate during a critical period so the lane may operate independent of the through lanes. The storage length should be sufficient to prevent vehicles spilling back from the auxiliary lane into the adjacent through lane. Storage length is a function of the cycle length, signal phasing, rate of arrivals and departures, and vehicle mix. As a rule-of-thumb, the left-turn lane should be designed to accommodate one and one-half to two times the average number of vehicle queues per cycle, although methods vary by jurisdiction. The *Highway Capacity Manual* can also be used to estimate queues, as noted in chapter 7.⁽²⁾

Lane width. Lane width requirements for left-turn lanes are largely based on operational considerations. Generally, lane widths of 3.6 m (12 ft) are desirable to maximize traffic flow; however, right-of-way or pedestrian needs may dictate use of a narrower lane width. For situations where it is not possible to achieve the standard width for a left-turn lane, providing a less-than-ideal lane is likely an improvement over providing no left-turn lane. Lane widths less than 2.7 m (9 ft) are not recommended for new design, but in some very constrained retrofit situations on lower speed roadways, lane widths as low as 2.4 m (8 ft) for some left-turning movements may be a better choice than not providing any left-turn lane or having too few left-turn lanes. Achieving more lanes through restriping from 3.6-m (12-ft) lanes to narrower lanes should be considered where appropriate.^(50,183) Figure 117 shows an example from Montgomery County, MD, where a narrow left-turn lane has been used effectively.



Figure 117. Narrow (2.4-m (8-ft)) left-turn lanes may be used effectively in retrofit situations.

Offset. A left-turning driver's view of opposing through traffic may be blocked by left-turning vehicles on the opposite approach. When left-turning traffic has a permissive green signal phase, this can lead to collisions between vehicles turning left from the major road and through vehicles on the opposing major-road approach. Offset left-turn lanes position vehicles on approaches further to the left, which removes the vehicles from the sight lines of the opposing left-turners. This helps improve safety and operations of the left-turn movement by improving driver acceptance of gaps in opposing through traffic and eliminating the potential for vehicle path overlap. This is especially true for older drivers who have difficulty judging gaps in front of oncoming vehicles. AASHTO policy recommends that medians wider than 5.4 m (18 ft) should have offset left-turn lanes. One method for laterally shifting left-turning vehicles is to narrow the turn-lane width using pavement markings. This is accomplished by painting a wider stripe or buffer area at the right side of the left-turn lane, which causes left-turning vehicles to position closer to the median. Wider lane lines were implemented at six intersections in Nebraska with positive results.⁽¹⁸⁴⁾ The width of these lines ranged from 150 mm to 900 mm (0.5 ft to 3 ft). The wider the left-turn lane line used to offset vehicles, the greater the effect on improving sight distance.

Offset left-turn lanes should remain parallel to the through travel route. A tapered left-turn design positions a turning vehicle at an angle. If struck from behind, the left-turn vehicle could be pushed into the oncoming through lane. Figure 118 illustrates a positive offset of left-turn lanes at an intersection.⁽¹²⁾

Miscellaneous. In constrained areas, through lanes are sometimes converted to left-turn lanes. In this situation, it is important that through lanes converted to turn lanes do not appear to be through lanes. Making the driver aware of this situation using lane markings and/or signs is important. One study indicates that the incidence of rear-end crashes increases in these situations.⁽¹⁸⁵⁾ The design of the left-turn lane is critical to its effectiveness as a safety or operational improvement strategy.

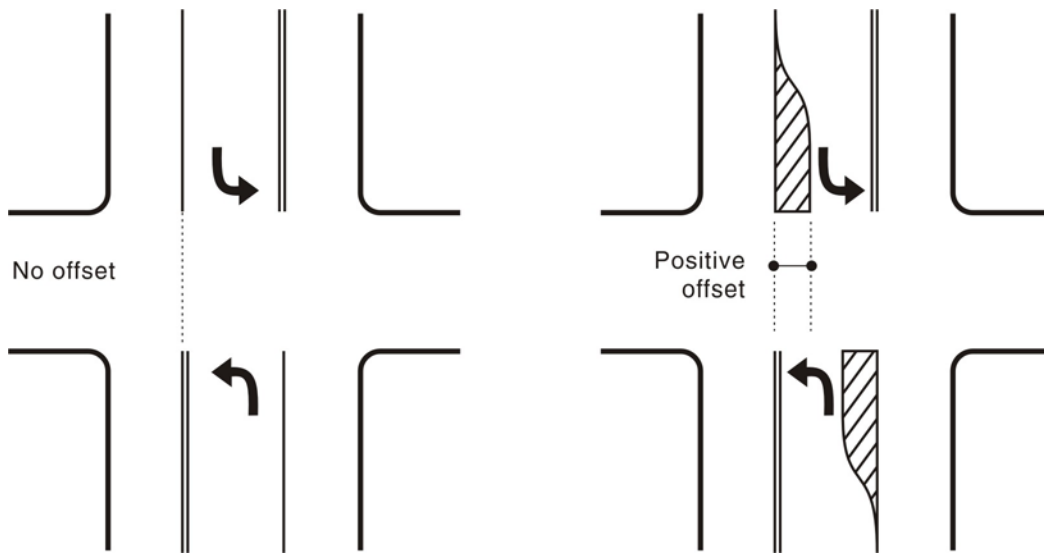


Figure 118. Example of positive offset. ^(adapted from 12)

Channelization

Physical channelization of left turns emphasizes separation of left-turning vehicles from the through traffic stream. It guides drivers through an intersection approach, increasing capacity and driver comfort.

A left-turn channelization design should incorporate consideration of the design vehicle, roadway cross section, traffic volumes, vehicle speeds, type and location of traffic control, pedestrians, and bus stops. In addition to these design criteria, consideration should be given to the travel path; drivers should not have to sharply change direction in order to follow the channelization. Channelizing devices should not cause drivers to make turns with angles that vary greatly from 90 degrees. If median treatments are used to channelized the left turn, pedestrian needs identified in chapter 8 should be considered. Additional guidance is provided in the AASHTO policy.⁽³⁾

Channelization can be provided using curbed concrete or painted islands, or delineators. The appropriateness of raised or flush medians depends on conditions at a given intersection. Painted channelization provides guidance to drivers without presenting an obstruction in the roadway, and would be more appropriate where vehicles may be proceeding through the intersection at high speeds. However, paint is more difficult to see at night, especially at intersections that are not lighted.

Raised curbed islands should provide guidance in the intersection area but should not present a significant obstruction to vehicles. Safety advantages of left-turn lanes with raised channelization include:

- Turning paths are clearly defined within an expansive median opening.
- Improved visibility for left-turning drivers.
- Simultaneous opposing left-turn lanes are offset from one another.
- Sideswipe collisions due to motorists' changing from left to through lanes or vice versa are prevented.

Raised pavement markings and “flex-post” delineators should be considered when use of raised channelization is not possible.

Operational Features

The type of signal phasing used for a left-turn movement directly affects safety and operational performance of the turn. In general, less-restrictive phasing schemes are preferable where appropriate because they result in lower delay to all users of the intersection.

Table 118 presents suggested guidelines for determining whether left-turn phasing is appropriate, and table 119 presents suggested guidelines for determining the type of left-turn phasing. In addition, table 120 presents the minimum recommended sight distance for permissive left turns. Note that many agencies have adopted guidelines such as these with localized variations to reflect State policy. Examples of deviations include the following:

- Some States have a policy to always use protected-only left-turn phasing where the left-turn movement crosses three lanes, while other States allow the use of permissive phasing or protected-permissive phasing in those situations.
- Some States use values in the criteria that are more conservative than provided here, such as lower crash frequency thresholds for protected-only left-turn phasing.
- At least one municipality (Tucson, AZ) allows the use of protected-permissive phasing at double left turns, while most States use protected-only phasing for those locations.

Table 118. Guidelines for use of left-turn phasing.^(186,187)

Left-turn phasing (protected-permissive, permissive-protected, or protected-only) should be considered if any one of the following criteria is satisfied:

1. A minimum of 2 left-turning vehicles per cycle and the product of opposing and left-turn hourly volumes exceeds the appropriate following value:
 - a. Random arrivals (no other traffic signals within 0.8 km (0.5 mi))
One opposing lane: 45,000 Two opposing lanes: 90,000
 - b. Platoon arrivals (other traffic signals within 0.8 km (0.5 mi))
One opposing lane: 50,000 Two opposing lanes: 100,000
 2. The left-turning movement crosses 3 or more lanes of opposing through traffic.
 3. The posted speed of opposing traffic exceeds 70 km/h (45 mph).
 4. Recent crash history for a 12-month period indicates 5 or more left-turn collisions that could be prevented by the installation of left-turn signals.
 5. Sight distances to oncoming traffic are less than the minimum distances in table 119.
 6. The intersection has unusual geometric configurations, such as five legs, when an analysis indicates that left-turn or other special traffic signal phases would be appropriate to provide positive direction to the motorist.
 7. An opposing left-turn approach has a left-turn signal or meets one or more of the criteria in this table.
 8. An engineering study indicates a need for left-turn signals. Items that may be considered include, but are not necessarily limited to, pedestrian volumes, traffic signal progression, freeway interchange design, maneuverability of particular classes of vehicles, and operational requirements unique to preemption systems.
-

Table 119. Guidelines for selection of type of left-turn phasing.^(186,187)

The type of phasing to use can be based on the following criteria:

1. Permissive left-turn phasing may be considered at sites that do not satisfy any of the left-turn phasing criteria listed in table 118.
 2. Protected-permissive left-turn phasing may be considered at sites that satisfy one or more of the left-turn phasing criteria listed in table 118 but do not satisfy the phasing criteria for protected-only phasing (see criterion 4 below). Protected-permissive phasing is not appropriate when left-turn phasing is installed as a result of an accident problem.
 3. Permissive-protected left-turn phasing may be considered at sites that satisfy the criteria for protected-permissive phasing and one of the following criteria:
 - a. The movement has no opposing left turn (such as at a “T” intersection) or the movement is prohibited (such as at a freeway ramp terminal).
 - b. A protected-permissive signal display is used that provides the left-turning vehicle with an indication of when the driver must yield to opposing traffic, such as the “Dallas” display, flashing yellow arrow, or other such devices.
 4. Protected-only left-turn phasing should be considered if any one of the following criteria is satisfied:
 - a. A minimum of 2 left-turning vehicles per cycle and the product of opposing and left-turn hourly volumes exceeds 150,000 for one opposing lane or 300,000 for two opposing lanes.
 - b. The posted speed of opposing traffic exceeds 70 km/h (45 mph).
 - c. Left-turning crashes per approach (including crashes involving pedestrians) equal 4 or more per year, or 6 or more in 2 years, or 8 or more in 3 years.
 - d. The left-turning movement crosses three or more lanes of opposing through traffic.
 - e. Multiple left-turn lanes are provided.
 - f. Sight distances to oncoming traffic are less than the minimum distances in table 120.
 - g. The signal is located in a traffic signal system that may require the use of lead-lag left-turn phasing. This criterion does not apply if:
 - i. An analysis indicates lead-lag phasing is not needed.
 - ii. An analysis indicates that protected-permissive phasing reduces total delay more than lead-lag phasing.
 - iii. A protected-permissive signal display is used that allows a permissive left turn to operate safely opposite a lagging protected left-turn phase (see chapter 2 for discussion of left-turn trap).
 - h. An engineering study indicates a need for left-turn signals. Items that may be considered include, but are not necessarily limited to, pedestrian volumes, traffic signal progression, freeway interchange design, maneuverability of particular classes of vehicles, and operational requirements unique to preemption systems.
-

Table 120. Minimum recommended sight distance for allowing permissive left turns.

Metric		U.S. Customary	
Design Speed (km/h)	Design Intersection Sight Distance for Passenger Cars* (m)	Design Speed (mph)	Design Intersection Sight Distance for Passenger Cars* (ft)
30	50	20	165
40	65	25	205
50	80	30	245
60	95	35	285
70	110	40	325
80	125	45	365
90	140	50	405
100	155	55	445
110	170	60	490
120	185	65	530

* For a passenger car making a left turn from an undivided highway. For other conditions and design vehicles, the time gap should be adjusted and the sight distance recalculated. Source: Adapted from (3), exhibit 9-67

Safety Performance

Installation of a left-turn lane can be expected to decrease rear-end crashes and red light running crashes. NCHRP 279 reports a California study that found a 15 percent reduction in all crashes when left-turn lanes were constructed at signalized intersections without a protected left-turn signal phase, and a 35 percent reduction of crashes when a left-turn phase is provided.⁽⁴¹⁾ A separate study found that the installation of a left-turn lane on one major-road approach at signalized intersections reduces total crashes by 18 percent, and by 33 percent when left-turn lanes are installed on both major-road approaches.⁽¹⁸⁸⁾

The presence of a left-turn lane could create situations where vehicles are more likely to off-track. Large trucks and buses are more likely to off-track than passenger cars. Off-tracking increases the likelihood of sideswipe and head on crashes between left-turning and adjacent through vehicles and between opposing left-turning vehicles.

In providing left-turn lanes, vehicles in opposing left-turn lanes may block their respective drivers' view of approaching vehicles in the through lanes. This potential problem can be resolved by offsetting the left-turn lanes.

Table 121 shows safety benefits of left-turn geometric improvements. All collision modification factors suggest safety improvements associated with providing a left-turn lane at a signalized intersection. Collision types that would particularly benefit from a left-turn lane are rear-end and left-turn collisions. Provision of a left-turn lane in conjunction with protected left-turn phasing would appear to provide the most benefit.

Table 121. Safety benefits associated with left-turn lane design improvements: Selected findings.

Treatment	Finding
Left-turn lane—physical channelization ⁽¹²³⁾	26% estimated reduction in all collisions. 79% estimated reduction in head-on/sideswipe collisions.
Left-turn lane—painted channelization ⁽¹²³⁾	45% estimated reduction in all collisions. 63% estimated reduction in right-angle collisions. 39% estimated reduction in rear-end/overtaking collisions. 35% estimated reduction in left-turn collisions.
Left-turn lane with signal upgrade ⁽¹⁶⁶⁾	62% estimated reduction in all collisions. 67% estimated reduction in injury/fatal collisions. 58% estimated reduction in PDO collisions. 51% estimated reduction in right-angle collisions. 63% estimated reduction in rear-end collisions. 78% estimated reduction in left-turn collisions.
Left-turn lane, urban ⁽¹⁸⁹⁾	26% estimated reduction in all collisions. 66% estimated reduction in left-turn collisions.
Left-turn lane, no phase ⁽¹³²⁾	25% estimated reduction in all collisions. 45% estimated reduction in left-turn collisions.
Left-turn lane and phasing ⁽¹⁹⁰⁾	58% estimated reduction in all collisions.
Left-turn lane, left-turn phase ⁽¹⁷⁹⁾	35% estimated reduction in all collisions.

Operational Performance

The addition of a left-turn lane increases capacity for the approach by removing left-turn movements from the through traffic stream. The addition of a left-turn lane may allow for the use of a shorter cycle length or allocation of green time to other critical movements.

The additional pavement width associated with the left-turn lane increases the crossing width for pedestrians and may increase the minimum time required for pedestrians to cross. In addition, the wider roadway section likely will increase the amount of clearance time required for the minor street approach. Restriping the roadway with narrower lanes can minimize this problem.

If a left-turn lane is excessively long, through drivers may enter the lane by mistake without realizing it is a left-turn lane. Effective signing and marking of the upstream end of the left-turn lane should remedy this problem.

Multimodal Impacts

For cases where widening is required to add a left-turn lane, the crossing distance and conflict area for pedestrians will increase. For wide roadway sections, pedestrian refuges (along with push buttons) should be considered.

The design of a left-turn lane should consider the volumes of truck and bus traffic that would be using the lane.

Physical Impacts

Addition of a left-turn lane will increase the footprint of the intersection if no median is currently present, except when the approach is restriped with narrower lanes. The approach to the intersection will be wider to accommodate the auxiliary lane.

Designers should also use caution when considering restriping a shoulder to provide or lengthen a left-turn lane. Part of the safety benefits of installing the turn lane may be lost due to a loss of shoulder, less proximity to roadside objects, and a reduction in intersection sight distance. In addition, the shoulder may not have been designed and constructed to a depth that will support considerable traffic volumes and may require costly reconstruction.

Socioeconomic Impacts

The potential reduction in travel time and in vehicle emissions is a benefit of left-turn lanes. A certain degree of comfort is provided to drivers when they are able to wait to turn outside of the through traffic stream, since they are not delaying other vehicles and can wait for a comfortable gap.

The cost of construction and the accompanying signing and striping are one of the main economic disadvantages to installing a left-turn lane. Also, access to properties adjacent to the intersection approach may need to be restricted when a left-turn lane is installed.

Enforcement, Education, and Maintenance

Periodic enforcement may be needed to prevent red light running.

Given that left-turn lanes are common at signalized intersections, no education should be needed to prepare drivers for installation of a lane at an intersection.

Maintenance issues for left-turn lanes will be the same as for other areas of the intersection. Pavement markings and signs should be kept visible and legible. Pavement skid resistance should be maintained.

Summary

Table 122 provides a summary of the issues associated with left-turn lanes.

Table 122. Summary of issues for left-turn lanes.

Characteristic	Potential Benefits	Potential Liabilities
Safety	Separation of left-turn vehicles from through movements.	Increased pedestrian exposure.
Operations	Additional capacity. Potential for shorter cycle lengths and/or allocation of green to other movements.	None identified.
Multimodal	Left-turn lane may result in shorter pedestrian delays due to shorter cycle length.	Depending on design, may result in longer crossing time and exposure for pedestrians.
Physical	None identified.	Increased intersection size.
Socioeconomic	Travel time reduced. Vehicle emissions reduced.	Right-of-way and construction costs. Access restrictions to property.
Enforcement, Education, and Maintenance	None identified.	None identified.

* Applies to situations where the left-turn lane is added by physical widening rather than restriping.

12.1.2 Multiple Left-Turn Lanes

Multiple left-turn lanes are becoming more widely used at signalized intersections where traffic volumes have increased beyond the design volume of the original single left-turn lane.

Multiple left-turn lanes can be used to address left-turn volumes that exceed or are expected to exceed a single turn lane. Multiple left-turn lanes allow for the allocation of green time to other critical movements or use of a shorter cycle length.

Applicability

Double and triple left-turn lanes are appropriate at intersections with significantly high left-turn volumes that cannot be adequately served in a single lane. As a rule of thumb, dual left-turn lanes are generally considered when left-turn volumes exceed 300 vehicles per hour (assuming moderate levels of opposing through traffic and adjacent street traffic). A left-turn demand exceeding 600 vehicles per hour indicates a triple left-turn may be appropriate.

While effective in improving intersection capacity, double or triple lefts are not appropriate where:

- A high number of vehicle-pedestrian conflicts occur.
- Left-turning vehicles are not expected to evenly distribute themselves among the lanes.
- Channelization may be obscured.
- Sufficient right-of-way is not available to provide for the design vehicle.

Design Features

The design of multiple left-turn lanes is similar to that of single turn lanes. In addition, the interaction between vehicles in adjacent lanes and also width of the receiving lanes should be considered. The following are design considerations for triple left-turn lanes provided by Ackeret.⁽¹⁹¹⁾ These same considerations apply for double left-turn lanes:

- Widths of receiving lanes.
- Width of intersection (to accommodate three vehicles abreast).
- Clearance between opposing left-turn movements during concurrent maneuvers.
- Pavement marking visibility.
- Placement of stop bars for left-turning and through vehicles.
- Weaving movements downstream of turn.
- Potential for pedestrian conflict.

The previous section provided criteria for selecting the type of signal phasing to be used. In general, protected-only left-turn phasing is used for most double-lane and triple-lane left-turn movements, although some agencies have used protected-permissive phasing for double left turns.

Operational Features

Drivers may be confused when attempting to determine their proper turn path on an approach with multiple left-turn lanes. Providing positive guidance for the driver in the form of pavement markings can help eliminate driver confusion and eliminate vehicle conflict by channeling vehicles in their proper turn path.

Delineation of turn paths is especially useful to drivers making simultaneous opposing left turns, as well as in some cases where drivers turn right when a clear path is not readily apparent. This strategy is also appropriate when the roadway alignment may be confusing or unexpected.

Delineation of turn paths is expected to improve intersection safety, though the effectiveness has not been well evaluated. The additional guidance in the intersection will help separate vehicles making opposing left turns, as well as vehicles turning in adjacent turn lanes.

Additional operational features of dual and triple left-turn lanes are identified below.

- Prominent and well-placed signing should be used with triple left-turn movements, especially in advance of the intersection.
- The excess green time for left-turn movements resulting from the additional lane should be allocated to other critical movements or removed from the entire cycle to reduce the cycle length.
- See tables 118 and 119 for left-turn phasing guidelines.

Safety Performance

A literature review shows that dual left-turn lanes with protected-only phasing generally operate with minimal negative safety impacts. Common crash types in multiple turn lanes are sideswipes between vehicles in the turn lanes. Turn path delineation guides drivers through their lane and can help reduce sideswipes at left-turn maneuvers.

A study of double and triple left-turn lanes in Las Vegas, NV, showed that about 8 percent of intersection-related sideswipes occur at double lefts, and 50 percent at triple lefts.⁽¹⁹²⁾ These sideswipes are 1.4 and 9.2 percent of all crashes at the intersections with double and triple lefts, respectively. Turn path geometry and elimination of downstream bottlenecks are important considerations for reducing sideswipes.

One study indicates that triple left-turn lanes have been shown to operate well, and drivers do not have trouble understanding the triple left turns.⁽¹⁹³⁾ In addition, construction of triple left-turn lanes has not resulted in unexpected or unacceptable crash experiences. Another study showed that 10 percent of the crashes at intersections with triple lefts occurred in the approach for the triple left. These are angle crashes that occur when left-turning vehicles collide with through traffic on the cross street. These crashes are attributed to short clearance intervals and limited sight distance, not operation of the triple left. Public education of the proper use of triple left turns will be necessary where these are being considered at an intersection.

Table 123 presents selected findings of the safety benefits of multiple left-turn lanes.

Table 123. Safety benefits associated with multiple left-turn lanes: Selected findings.

Treatment	Finding
Double left-turn lane ⁽¹⁷²⁾	29% estimated reduction in all fatal/injury collisions. 26% estimated reduction in all PDO collisions. 29% estimated reduction in fatal/injury rear-end collisions. 47% estimated reduction in fatal/injury left-turn collisions. 20% estimated reduction in angle fatal/injury collisions.

Operational Performance

Multiple left-turn lanes can improve intersection operations by reducing the time allocated to the signal phase for the left-turn movement. Triple left-turn lanes have been constructed to meet the left-turn capacity demand without having to construct an interchange. This configuration can accommodate left-turn volumes of more than 600 vehicles per hour. Vehicle delays, intersection queues, and green time for the left-turn movement are all reduced, improving operation of the entire intersection.

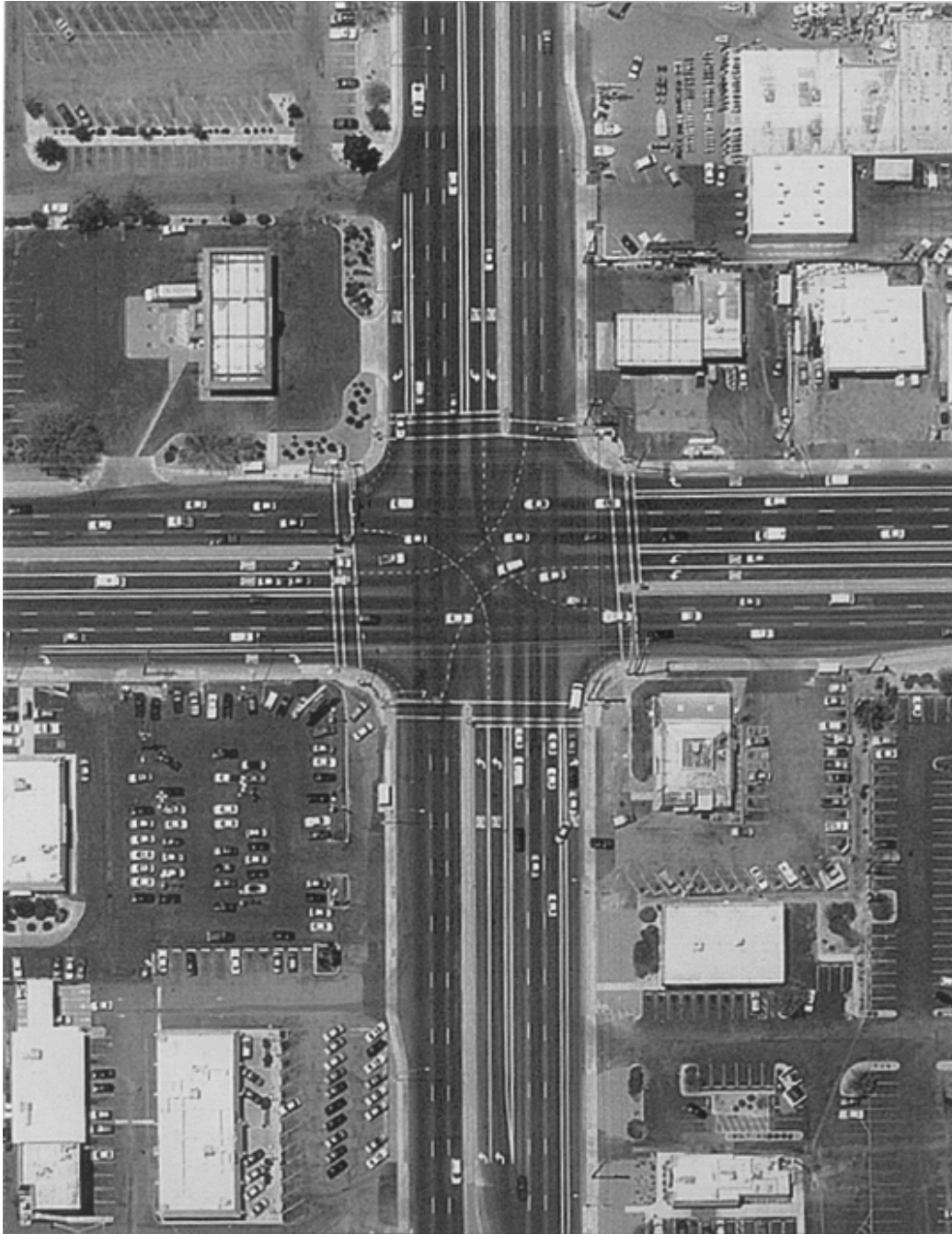
While dual left-turn lanes are largely operated with protected-only phasing, some agencies use protected-permissive signal phasing. This signal phasing improves capacity for the left-turn movements, particularly during nonpeak times when opposing traffic volumes are lower. Many agencies have safety concerns regarding permissive left-turns in a double turn lane. In fact, many

agencies only allow dual left-turn lanes to be run as protected-only phasing. However, some agencies overcome this concern by offsetting the dual left turn lanes.

Tucson, AZ, uses protected-permissive offset dual left-turns at approximately 30 intersections. The city has been using this treatment for about 30 years with limited reported problems, and continues to install them where needed. The protected-permissive "offset" dual lefts are used on very high volume city streets (with ADTs exceeding 80,000). The capacity of the left-turn movement increases 75 to 80 percent and left-turn crashes increase only insignificantly with the protected-permissive phasing is implemented. One potential issue is sight distance for the left-turning vehicles. The City of Tucson addresses this concern by offsetting the far lane by 1.2 to 1.5 m (4 to 5 ft) so that it has the same sight distance as a single left-turn lane, enabling drivers to see beyond the opposing left-turn vehicles, as shown in figure 119.⁽¹⁹⁴⁾

For protected-permissive dual lefts, Tucson, AZ, also uses a lagging left-turn phase operation. The Arizona Insurance Information Association studied this operation in 2002.⁽¹⁹⁵⁾ The study found that Tucson, AZ, had lower crash rates than the leading left-turn operations in the Phoenix, AZ, area, and this benefit was attributed in part to the use of lagging left phases.

On the other hand, in a study of four non-offset intersections with dual left-turn lanes in Atlanta, GA, operating with protected-permissive signal phasing, it was shown that this signal phasing needs to be carefully considered.⁽¹⁹⁶⁾ The advantage of increased capacity compared to the disadvantage of increased vehicle conflicts illustrated that this type of phasing may not be appropriate. This study was based on a limited data set, and more sites should be studied to verify these results.



Photograph Credit and Copyright: City of Tucson, Arizona, 1998

Figure 119. Intersection with turn paths delineated for dual left-turn lanes and offsets in Tucson, AZ (Kolb Road/22nd Street), June 1998.

Multimodal Impacts

Adding turn lanes increases the crossing distance for pedestrians, as well as their exposure to potential conflicts if roadway widening is required.

Physical Impacts

Installation of a second or third turn lane will increase the footprint of the intersection, except when additional lanes can be accommodated through restriping. As with single left-turn lanes, right-of-way costs and access to adjacent properties are significant issues to consider.

Socioeconomic Impacts

A shorter green time for left-turning vehicles, made possible by multiple turn lanes, can provide more green time to other movements. As this reduces delay, it will also reduce vehicle emissions.

Enforcement, Education, and Maintenance

Little or no education should be needed for multiple left-turn lanes that operate with protected-only or split phasing other than lane assignment signing and markings. Some public information may be needed to educate drivers regarding a permissive movement at a double left-turn lane.

Summary

Table 124 summarizes the issues associated with multiple left-turn lanes.

Table 124. Summary of issues for multiple left-turn lanes.

Characteristic	Potential Benefits	Potential Liabilities
Safety	Potential reduction in collisions.	None identified.
Operations	Potential improvement in capacity.	None identified.
Multimodal	None identified.	Longer crossing distance and more exposure.
Physical	None identified.	Multiple turn lanes may increase the footprint of the intersection.
Socioeconomic	Potential reduction in vehicle emissions due to lower delay.	None identified.
Enforcement, Education, and Maintenance	None identified.	Some education may be needed for double left-turn lanes with permissive phasing.

12.1.3 Turn Prohibition

Safety and operations at some signalized intersections can be enhanced by restricting turning maneuvers, particularly left turns, during certain periods of the day (such as peak traffic periods) or by prohibiting particular turning movements altogether. Signing or channelization can be implemented to restrict or prohibit turns at intersections.

Prohibiting or restricting left turns should practically eliminate crashes related to the affected turning maneuver. Alternative routes should be analyzed to ensure that crash rates and operational problems do not increase due to diversion of traffic to these alternatives. Also, the benefit of restricting turns may be reduced by an increase in accidents related to formation of queues (rear-end collisions).

U-turning vehicles proceed through an intersection at a slower speed than left-turning vehicles and can have an adverse effect on both operations and safety at the intersection. Prohibition of U-turns may be appropriate at intersections with high volumes for movement with which U-turns interfere. Slower moving U-turning traffic will reduce the capacity of a left-turn movement. Drivers attempting to make a U-turn during a permitted left-turn phase may interfere

with opposing through traffic. Rear-end crashes involving U-turning vehicles followed by left-turning or through vehicles may be a sign of operational problems with the U-turn maneuver.

Sight distance limitations should be considered. If opposing left-turning vehicles waiting in a turn lane block a U-turning driver's view of oncoming through traffic, prohibition of U-turn (as well as left-turn) maneuvers on a permissive left-turn phase may be appropriate.

The turning radius of the design vehicle should be accommodated by the combination of the median and receiving lane width. A shorter turn radius will cause slower speeds for U-turning vehicles, and will result in more delay to following vehicles.

Due to the adverse effect U-turns have on intersection capacity and safety, it is sometimes preferable to prohibit U-turns, especially at busy intersections. U-turning vehicles have a greater operational effect on succeeding vehicles than do left-turning vehicles. One study suggests adjusting for U-turns differently from left-turns when determining saturation flow rates of left-turn lanes, to account for their larger effect on operations.⁽¹⁹⁷⁾

Prohibition of a U-turn is typically implemented with signing. Enforcement may be necessary to ensure the prohibition is obeyed.

Selected findings of the safety benefits for various left-turn operational treatments are presented in table 125.

Table 125. Safety benefits associated with left-turn operational treatments: Selected findings.

Treatment	Finding
Add protected left-turn ⁽¹²³⁾	56% estimated reduction in right-angle collisions. 35% estimated reduction in rear-end/overtaking collisions. 46% estimated reduction in left-turn collisions.
Add protected left-turn ⁽¹⁹⁸⁾	64% estimated reduction in all collisions.
Left-turn phasing ⁽¹⁸⁹⁾	12% estimated reduction in all collisions. 38% estimated reduction in left-turn collisions.
Add protected-permissive left-turn phase ⁽¹³²⁾	10% estimated reduction in all collisions. 40% estimated reduction in left-turn collisions.
Prohibit left turns ⁽¹⁴⁰⁾	50% estimated reduction in rear-end collisions. 50% estimated reduction in turning collisions. 50% estimated reduction in loss-of-control collisions.

Summary

Table 126 summarizes the issues associated with turn prohibitions.

Table 126. Summary of issues for turn prohibitions.

Characteristic	Potential Benefits	Potential Liabilities
Safety	Potential reduction in collisions.	None identified.
Operations	Potential increase in capacity and reduction in delay due to reduction of the number of phases.	None identified.
Multimodal	Fewer conflicts with turning vehicles. Lower delay to all users.	None identified.
Physical	None identified.	None identified.
Socioeconomic	None identified.	None identified.
Enforcement, Education, and Maintenance	None identified.	Enforcement of turn restrictions may be needed.

12.2 THROUGH LANE TREATMENTS

12.2.1 Provide Auxiliary Through Lanes

Auxiliary through lanes (i.e. additional through lanes with limited length) can be added at signalized intersections to provide added capacity for through movements. The amount of added capacity achieved depends on the extent to which through vehicles use the auxiliary lane. Various factors (such as the length of the auxiliary lane, turn volumes, and overall operation of the intersection) contribute to how many vehicles will use an auxiliary lane.

Description

Auxiliary lanes are generally provided on the approaches of a signalized intersection in advance of the intersection and dropped downstream of the intersection. Right-turn traffic may share the outside lane with a portion of the through vehicles, or there may be a separate exclusive right-turn lane. The auxiliary lane also provides an acceleration lane for vehicles turning right from the adjacent approach. Figure 120 illustrates an auxiliary through lane.

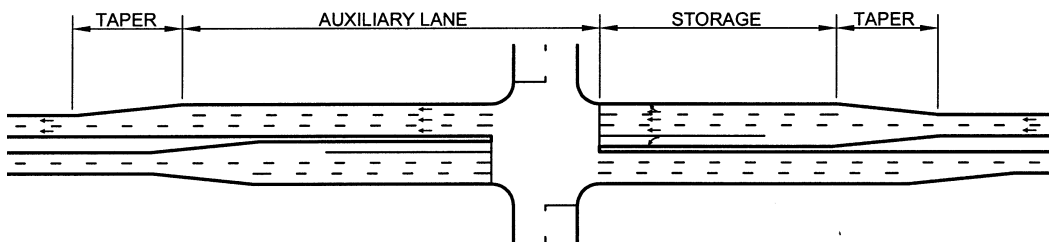


Figure 120. Diagram of an auxiliary through lane. ^(adapted from 199)

Applicability

Auxiliary lanes are applicable for arterials that have adequate capacity along midblock segments but require additional capacity at signalized intersection locations. The full benefit of an auxiliary lane will not be realized if a bottleneck or constraint exists on the arterial upstream or downstream of the intersection.

Design Features

The length of the auxiliary lane on both sides of an intersection is a determining factor in whether the lane will be used; longer lanes get more use by through vehicles than do shorter ones.⁽²⁰⁰⁾ Ideally, the lane should be long enough to allow vehicles turning right off the road to decelerate, and vehicles turning right onto the road to accelerate and merge.

Operational Features

Unless a separate right-turn lane is provided, both through and right-turning vehicles may use the additional lane. More vehicles are likely to use the auxiliary lane if there is not adequate green time to clear the signal from the inside through lane. Using relatively short green times for the approach will clear vehicle queues and likely result in a higher utilization of the outside auxiliary lane.

Safety Performance

Based on the subjective assessment of the authors, the safety experience of an intersection with auxiliary through lanes should not be significantly different from conventional intersections without the additional lane. The downstream merge maneuver that this design requires may lead to an increase in merge-related collisions (sideswipes), but studies have not evaluated this.

Operational Performance

Tarawneh summarized research performed on auxiliary through lanes and concludes:⁽²⁰⁰⁾

- Auxiliary lane use by through vehicles increases with the increase in lane length downstream of the intersection and with the increase in delay experienced by the through/right-turning vehicles.
- Auxiliary lane use by through vehicles decreases with an increase in right-turning vehicles (right-turn volume greater than 15 percent of the approach volume renders the auxiliary lane useless to through vehicles) unless there is a separate right-turn lane.
- Auxiliary lane length, intersection delay, and the proportion of right-turning vehicles work together in determining the utility of an auxiliary through lane.
- Lane utilization factors observed in this study (0.73 to 0.82) are less than HCM default values (0.91 for a three lane group).⁽²⁾

Hurley introduces the concept of captive and choice users of an auxiliary through lane.⁽¹⁹⁹⁾ These concepts are described above. Sites were studied in Tennessee to identify the factors that affect the choice of using an auxiliary lane. These factors were:

- Through flow rate.
- Right turns off the facility in the last 150 m (500 ft) of an auxiliary lane.
- Downstream auxiliary lane length.
- Size of urban area.

Multimodal Impacts

Wider intersections result in longer crossing times for pedestrians and bicyclists, as well as increased exposure to vehicle conflicts.

Physical Impacts

Adding an auxiliary through lane will increase the footprint of the intersection if no median is currently present. The approach to the intersection will be wider to accommodate the auxiliary lane.

Socioeconomic Impacts

Driver perception of the benefits of the auxiliary through lane will determine how often the lane is used by through vehicles. If right-turn volumes are high enough that drivers do not benefit from using the lane, capacity of the through movement will not improve significantly.

The cost of construction and the accompanying signing and striping are among the main economic disadvantages to installation of an auxiliary lane. Also, access to properties adjacent to the intersection approach may need to be restricted when another lane is constructed. Property owners affected by the restrictions, especially business owners, may be opposed to the auxiliary lanes.

Enforcement, Education, and Maintenance

Auxiliary through lanes do not present any special enforcement issues.

No public education should be needed to inform drivers how to proceed through the intersection. Signs and pavement markings describing the lane arrangements should be sufficient.

Maintenance issues for through auxiliary lanes will be the same as for other areas of the intersection. Pavement markings and signs should be kept visible and legible.

Summary

Table 127 summarizes the issues associated with auxiliary through lanes.

Table 127. Summary of issues for auxiliary through lanes.

Characteristic	Potential Benefits	Potential Liabilities
Safety	None identified.	Potential for sideswipes downstream of merge.
Operations	Decreased delay for through vehicles.	None identified.
Multimodal	None identified.	Longer pedestrian crossing time and exposure.
Physical	None identified.	Larger intersection footprint.
Socioeconomic	None identified.	Construction costs. Driver perception of delay. Access to properties.
Enforcement, Education, and Maintenance	None identified.	None identified.

12.2.2 Delineate Through Path

At complex intersections where the correct path through the intersection may not be immediately evident to drivers, pavement markings may be needed to provide additional guidance. The same markings are used to delineate turning paths through intersections for multiple turn lanes. These markings are a continuation of the longitudinal lane stripes, but have a different stripe and skip pattern. An example of these markings is given in figure 121.

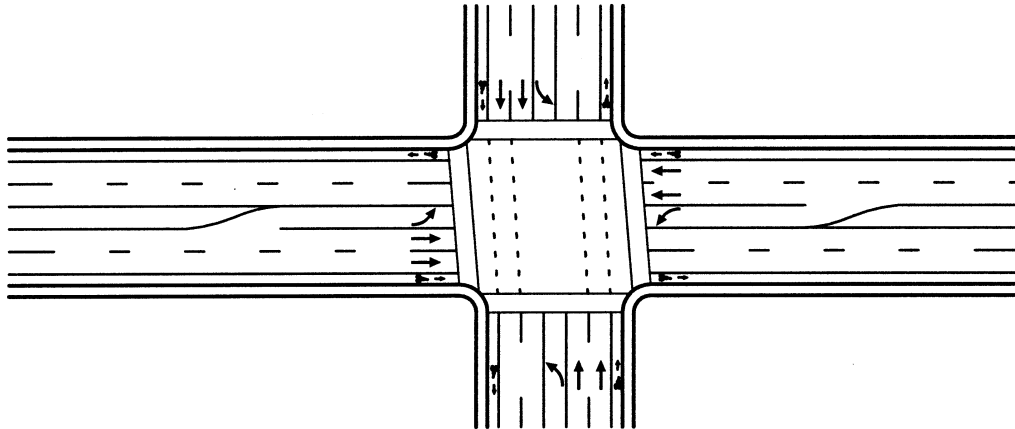


Figure 121. Example of delineated paths.

Intersections where through vehicles cannot proceed through the intersection in a straight line may benefit from pavement markings that guide drivers along the appropriate path. Skewed intersections, intersections where opposing approaches are offset, and multileg intersections may all present situations where additional guidance can improve safety and operations.

Delineation of the through path should help reduce driver confusion in the intersection, which will reduce erratic movements as drivers steer into or out of the appropriate path. This would reduce the potential for sideswipe, rear-end, and head-on crashes.

Pavement markings through the intersection should account for off-tracking of large (design) vehicles. The markings should be spaced far enough apart to allow off-tracking without crossing over the markings.

The cost of installing and maintaining the pavement markings should be the only costs of this treatment, and should be similar to that of other pavement markings on the approaches.

Summary

Table 128 summarizes the issues associated with path delineation.

Table 128. Summary of issues for path delineation.

Characteristic	Potential Benefits	Potential Liabilities
Safety	Fewer erratic maneuvers.	None identified.
Operations	Fewer erratic maneuvers.	None identified.
Multimodal	None identified.	Potential off-tracking of large vehicles.
Physical	None identified.	Installation costs.
Socioeconomic	None identified.	Maintenance costs.
Enforcement, Education, and Maintenance	None identified.	None identified.

12.3 RIGHT-TURN TREATMENTS

The treatments in this section are: addition of a right-turn lane, double right-turn lanes, and a channelized right-turn lane.

12.3.1 Add Single Right-Turn Lane

Significant volumes of right-turning traffic can have an adverse effect on both intersection operations and safety. The deceleration of the turning vehicles creates a speed differential between them and the through vehicles. This can lead to delay for the through vehicles, as well as rear-end crashes involving both movements.

In addition to providing safety benefits for approaching vehicles, right-turn lanes at signalized intersections can be used to reduce vehicular delay and increase intersection capacity.

Figure 122 illustrates the design features of a right-turn lane.

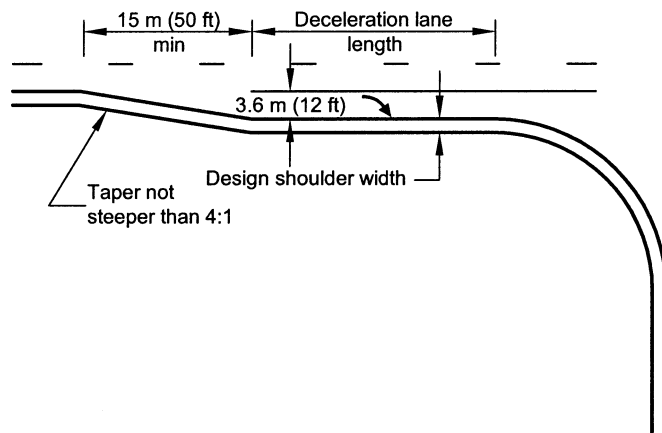


Figure 122. Diagram of a typical right-turn lane. (adapted from 201)

Right-Turn Lane Warrants

Similar to left-turn lane warrants, adopted guidelines and practices from local agencies should be reviewed when determining if a right-turn lane is warranted. Factors that should be considered include vehicle speeds, turning and through volumes, percentage of trucks, approach capacity, desire to provide right-turn-on-red operation, type of highway, arrangement/frequency of intersections, crash history involving right turns, pedestrian conflicts, and available right-of-way.

NCHRP 279 identifies warrants for right-turn lanes on four-lane, high-speed roadways, shown in table 129.⁽⁴¹⁾ These warrants are based on the percentage of vehicles turning right (as a percentage of through vehicles) during the peak period.

Table 129. Right-turn lane volume warrants.⁽⁴¹⁾

State	Conditions Warranting Right-Turn Lane off Major (Through Highway)		
	Through Volume	Right-Turn Volume	Highway Conditions
Alaska	N/A	DHV = 25 vph	
Idaho	DHV = 200 vph	DHV = 5 vph	2 lanes
Michigan	N/A	ADT = 600 vpd	2 lanes
Minnesota	ADT = 1,500 vpd	All	Design speed > 70 km/h (45 mph)
Utah	DHV = 300 vph	Crossroad ADT = 100 vpd	2 lanes
Virginia	DHV = 500	DHV = 40 vph	2 lanes
	All	DHV = 120 vph	Design speed > 70 km/h (45 mph)
	DHV = 1,200 vph	DHV = 40 vph	4 lanes
	All	DHV = 90 vph	
West Virginia	DHV = 500 vph	DHV = 250 vph	Divided highways
Wisconsin	ADT = 2,500 vpd	Crossroad ADT = 1,000 vpd	2 lanes

Notes: DHV = design hourly volume; ADT = average daily traffic; vph = vehicles per hour; vpd = vehicles per day

Design features

The key design criteria for right-turn lanes are: entering taper; deceleration length; storage length; lane width; corner radius; and sight distance. Design criteria for selecting an appropriate right-turn lane length are presented in *A Policy on Geometric Design for Highways and Streets* as well as in the policies of individual highway agencies.⁽³⁾

Entering taper and deceleration length. The entering taper and deceleration length should be determined based on vehicle speed. The length of storage should be designed to accommodate the maximum vehicle queue expected for the movement under design year conditions. From a functional perspective, the entering taper should allow for a right-turning vehicle to decelerate and brake outside of the through traffic lanes. This is particularly important at higher vehicle speeds. In urban areas, this is often difficult to achieve and some deceleration of a turning vehicle is expected to occur in the through travel lane.

Storage length. A right-turn lane should be sufficiently long to store the number of vehicles likely to accumulate during a critical period. The storage length should be sufficient to prevent vehicles from spilling back from the auxiliary lane into the adjacent through lane. At signalized intersections, the storage length required is a function of the cycle length, signal phasing arrangement, and rate of arrivals and departures. As a rule of thumb, the auxiliary lane should be designed to accommodate one and one-half to two times the average number of vehicle queues per cycle, although methods vary by jurisdiction. See chapter 7 for additional discussion regarding methodologies for estimating queue lengths/storage requirements.

In some cases, a right-turn lane may already be provided, but an increase in traffic volumes may necessitate lengthening it, which can help improve operations and safety by providing additional storage for right-turning vehicles. If the length of a right-turn lane is inadequate, right-turning vehicles will spill back into the through traffic stream, thus increasing the potential for rear-end collisions. Longer entering tapers and deceleration lengths can reduce this potential.

Lane width. Lane width requirements for right-turn lanes are largely based on operational considerations. Generally, lane widths of 3.6 m (12 ft) are desirable to maximize traffic flow; however, right-of-way or pedestrian needs may dictate use of a narrower lane width. Achieving more lanes through restriping from 3.6 m (12 ft) lanes to narrower lanes should be considered

where appropriate.⁽⁵⁰⁾ Figure 123 shows an example from Montgomery County, MD, where a narrow right-turn lane has been used effectively.



Figure 123. Narrow (2.4-m (8-ft)) right-turn lanes may be used effectively in retrofit situations.

Corner Radius. The corner radius influences the turning speed of vehicles. Large corner radii allow vehicles to turn at higher speeds. If low-speed, right-turn movements are desired, particularly in locations where pedestrian crossings occur, the curb radius should be minimized, yet still accommodate the turning path of the design vehicle. Pedestrian crossing distances will be minimized if curb radius is minimized. In addition, lower vehicle speeds can reduce the probability of a crash.

A larger curb radius is appropriate for situations where it is desirable for right-turning vehicles to exit the through traffic stream quickly. The right turn may operate as a free-flow movement if an acceleration lane is provided on the cross street, or the movement may be controlled by a yield sign where the turning roadway enters the cross street.

Increasing the turning radius can reduce the potential for sideswipe or rear-end collisions by reducing lane encroachments as a vehicle approaches a turn and as it enters the cross street. Also, some older drivers and drivers of large vehicles may have difficulty maneuvering; the rear wheels of their vehicles may ride up over the curb or swing out into other lanes where traffic may be present. For situations where a large turning radius is desired, the use of a channelization island may be appropriate to reduce unused pavement area. Unused pavement area contributes to driver confusion regarding the appropriate path through the intersection.

Sight distance. Adequate sight distance should be provided for vehicles in the right-turn lane or channelized right-turn movement. If right turns on red are permitted, drivers turning right should be able to view oncoming traffic from the left on the crossroad.

Safety Performance

Right-turn lanes are often used to preclude the undesirable effects resulting from the deceleration of turning vehicles. ITE's *Transportation and Land Development* indicates that a vehicle traveling on an at-grade arterial at a speed 16 km/h (10 mph) slower than the speed of the normal traffic stream is 180 times more likely to be involved in a crash than a vehicle traveling at the normal traffic speed.⁽⁸⁶⁾ Right-turn channelization has been shown to reduce right-turn angle crashes. However, the addition of a right-turn lane may result in an increase in sideswipe crashes. From a vehicular operations standpoint, larger curb radii generally result in vehicle turning paths that are in line with the pavement edge. In addition, larger curb radii produce higher vehicle speeds that can negatively impact the safety of pedestrians and bicyclists.

The provision of right-turn lanes minimizes collisions between vehicles turning right and following vehicles, particularly on high-volume and high-speed major roads. A right-turn lane may be appropriate in situations where there is an unusually high number of rear-end collisions on a particular approach. Installation of a right-turn lane on one major road approach at a signalized intersection is expected to reduce total crashes by 2.5 percent, and crashes are expected to decrease by 5 percent when right-turn lanes are constructed on both major-road approach.⁽¹⁸⁸⁾

Selected findings of safety benefits associated with various right-turn lane improvements are given in table 130.

Table 130. Safety benefits associated with right-turn improvements: Selected findings.

Treatment	Implication
Increase turn lane length ⁽¹³²⁾	15% estimated reduction in all collisions.
Add right-turn lane on multilane approach ⁽⁶⁸⁾	40% estimated reduction in fatal/injury collisions. 10% estimated reduction in PDO collisions.
Acceleration/deceleration lanes ⁽¹³²⁾	10% estimated reduction in all collisions.
Increase turning radii ⁽¹³²⁾	15% estimated reduction in all collisions.

Operational Performance

Right-turn lanes will remove decelerating and slower-moving vehicles from the through traffic stream, which will reduce delay for following through vehicles. Lin concluded that a right-turn lane may reduce vehicle delays substantially, even with the percentage of right-turns as low as 10 percent.⁽²⁰²⁾

It is possible that installation of a right-turn lane could create other safety or operational problems at the intersection. For example, vehicles in the right-turn lane may block the cross street drivers' view of through traffic; this would be a significant issue where right turns on red are permitted on the cross street. If a right shoulder is restriped to provide a turn lane, there may be adverse impacts on safety due to the decrease in distance to roadside objects. Delineation of the turn lane should be carefully considered to provide adequate guidance through the intersection.

If a right-turn lane is excessively long, through drivers may enter the lane by mistake without realizing it is a right-turn lane. Effective signing and marking the upstream end of the right-turn lane may remedy this.

Also, if access to a right-turn lane is blocked by a queue of through vehicles at a signal, drivers turning right may block the movement of through traffic if the two movements operate on separate phases. This could lead to unsafe lane changes and added delay.

Multimodal Impacts

The speed of turning vehicles is a risk to pedestrian safety.

The addition of a turn lane increases the crossing distance for pedestrians and may require additional time for the flashing DON'T WALK phase. Other issues to consider when designing a right-turn lane include potential conflicts between turning vehicles and cyclists proceeding through the intersection.

Transit stops may have to be relocated from the near side of an intersection, due to possible conflicts between through buses and right-turning vehicles.

Physical Impacts

Addition of a right-turn lane will increase the footprint of the intersection, unless the shoulder is restriped to create a turn lane. The approach to the intersection will be wider to accommodate the auxiliary lane.

Designers should use caution when considering restriping a shoulder to provide or lengthen a right-turn lane. Part of the safety benefits of installing the turn lane may be lost due to loss of shoulder, the greater proximity of traffic to roadside objects, and a possible reduction in intersection sight distance.

Socioeconomic Impacts

Installing or lengthening a right-turn lane on an intersection approach may involve restricting right turns in and out of driveways on that approach. Techniques include signing or construction of a raised median.

The cost of construction (including relocation of signal equipment) and right-of-way acquisition is the main disadvantage to installation of a turn lane. Also, access to properties adjacent to the intersection approach may need to be restricted when a turn lane is installed.

Enforcement, Education, and Maintenance

Periodic enforcement may be needed to prevent red-light violations, especially if right turns on red are prohibited.

Right-turn lanes are common, and minimal education should be needed to prepare drivers for their installation. Drivers may need a reminder that they should be watching for pedestrians crossing the departure lanes.

Maintenance issues for right-turn lanes will be the same as for other areas of the intersection. Pavement markings and signs should be kept visible and legible. Pavement skid resistance should be maintained.

Summary

Table 131 summarizes the issues associated with right-turn lanes.

Table 131. Summary of issues for right-turn lanes.

Characteristic	Potential Benefits	Potential Liabilities
Safety	Separation of right-turn vehicles.	None identified.
Operations	Higher right-turn capacity. Shorter green time. Less delay for following through vehicles. Additional storage for approach queues.	Potential for off-tracking of large vehicles.
Multimodal	None identified.	Longer pedestrian crossing distance, time, and exposure. Higher speed of right-turning vehicles increases risk to pedestrians. May require transit stop relocation.
Physical	None identified.	Larger intersection footprint.
Socioeconomic	None identified.	Right-of-way/construction costs. Access restrictions to property.
Enforcement, Education, and Maintenance	None identified.	Periodic enforcement may be needed to prevent red light violations, especially if right turns on red are prohibited.

12.3.2 Provide Double Right-Turn Lanes

High volumes of right-turning vehicles may support double right-turn lanes to increase capacity for the turns and reduce delay for other movements at the intersection. Double right-turn lanes can reduce both the length needed for turn lanes and the green time needed for that movement.

Approaches with right-turn volumes that cannot be accommodated in a single turn lane without excessively long green times (and delays for other approaches) may be appropriate locations for double turn lanes. Also, locations where right-of-way is not available to provide a long turn lane but there is space for two shorter turn lanes may be ideal for double turn lanes. Clearly, multiple turn lanes are not appropriate where only one receiving lane is available; however, consideration may be given to providing a departing auxiliary lane to allow for double right turns with a downstream merge.

As with single right-turn lanes, the design vehicle should be considered when determining length, width, and taper of the turn lane. The receiving lane should accommodate the turning radius of a large vehicle. Delineation of the turn path will guide drivers through the maneuver and help reduce crossing over into adjacent lanes while turning.

Typically, right turns on red are only permitted on the outside right-turn lane, if at all. NO TURN ON RED signing with appropriate lane-specific legends should be placed in a location visible to drivers (such as overhead), especially those in the inside turn lane.

Based on the subjective assessment of the authors, the safety experience of double right-turn lanes should be similar to that of single right-turn lanes. Rear-end collisions of decelerating right-turn vehicles and following through vehicles may be reduced after construction of the additional turn lane, because the turn lanes have a higher capacity for the slower vehicles. Even though the double turn lanes increase capacity, some deceleration may occur in the through lanes, depending on the length of the turn lanes. This could lead to rear-end crashes.

Sideswipes between turning vehicles are a possibility at double turn lanes. This is especially an issue if the turn radius is tight and large vehicles are likely to be using the turn lanes. Delineation of turn paths should help address this.

Construction of an additional right-turn lane can be reasonably expected to improve the operation of the intersection, provided that the affected right-turn movement is a critical movement. The additional deceleration and storage space should help prevent spillover into adjacent through lanes. Less green time should be needed for right-turn traffic, and this time thus can be allocated to other movements. However, a double turn lane will result in a wider footprint for the intersection and increase the distance pedestrians must cross, which increases their exposure to potential conflicts with vehicular traffic.

Acquisition of right-of-way to provide an additional turn lane may be expensive. If a departure auxiliary lane is to be constructed to allow for a downstream merge, this may also increase right-of-way costs. Access to adjacent properties may need to be restricted to provide a merge area. Owners of adjacent property should be involved in early discussions regarding the plans.

Lane use signing and signs prohibiting right turns on red from the inside turn lane should convey all the information that drivers would need. Periodic enforcement may be needed to ensure drivers obey any right turn on red prohibitions.

Summary

Table 132 summarizes the issues associated with double right-turn lanes.

Table 132. Summary of issues for double right-turn lanes.

Characteristics	Potential Benefits	Potential Liabilities
Safety	Separation of right-turn vehicles.	Potential for sideswipes.
Operations	Higher right-turn capacity. Shorter green time. Less delay for following through vehicles.	Off-tracking of large vehicles.
Multimodal	None identified.	Longer pedestrian crossing distance, time, and exposure.
Physical	Potentially shorter intersection footprint than needed for single turn lane.	Wider intersection footprint.
Socioeconomic	None identified.	Right-of-way costs. Access restrictions to property.
Enforcement, Education, and Maintenance	None identified.	None identified.

12.3.3 Provide Channelized Right-Turn Lane

Channelization of the right turn with a raised or painted island can provide larger turning radii and allow for higher turning speeds, and also can provide an area for pedestrian refuge. Figure 124 illustrates a channelized right-turn lane.

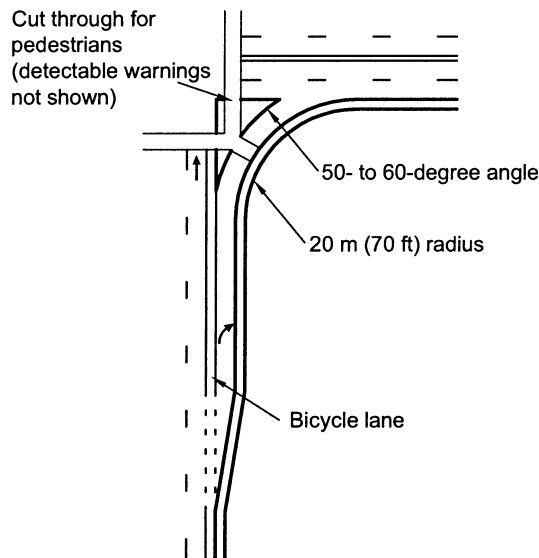


Figure 124. Example illustration of a channelized right-turn lane.

Applicability

Channelized right-turn lanes are applicable for intersections with a high volume of right-turning vehicles that experience excessive delay due to the traffic signal. The larger the turn radius, the higher vehicle speeds can be. An important consideration is the desired speed of the turning vehicles as they enter the crossroad. The turn radius can be used to control speed,

especially if the speed varies greatly from the road the vehicle is turning from. Larger turn radii and higher speeds are a safety issue for pedestrians.

A channelized right-turn lane will have a larger footprint than an intersection with a conventional right-turn lane. Additional right-of-way may be needed to accommodate the larger corner radius. Constructing a departure auxiliary lane to allow for a downstream merge may also increase right-of-way costs.

Key Design Features

Channelizing islands can be raised or flush with the pavement. A Georgia study evaluated the effects of right-turn channelization in the form of painted islands, small raised islands, and large raised islands.⁽²⁰³⁾ Results show that traffic islands appear to reduce the number of right-turn angle crashes, and the addition of an exclusive turn lane appears to correspond to an increased number of sideswipe crashes given the introduction of a lane change.

Operational Features

The right turn may operate as a free flow movement if an acceleration lane is provided on the cross street, or the movement may be controlled by a YIELD sign where the turning roadway enters the cross street. Periodic enforcement may be needed to ensure drivers obey any traffic control devices used for the right-turn roadway (such as a YIELD sign).

Visibility of channelizing islands is very important. Islands can be difficult for drivers to see, especially at night and in inclement weather. This is particularly true for older drivers. Raised islands have been found to be more effective than flush painted islands at reducing nighttime collisions, because they are easier to see.

Older drivers, in particular, benefit from channelization as it provides a better indication of the proper use of travel lanes at intersections. However, older drivers often find making a right turn without the benefit of an acceleration lane on the crossing street to be particularly difficult.

Safety Performance

A reduction in rear-end collisions involving right-turning vehicles and following through vehicles could be expected after construction of a right-turn roadway. Turning vehicles will not need to decelerate as much as they would for a standard right-turn lane, and therefore the speed differentials between turning and through vehicles would not be as great.

The potential for rear-end and sideswipe crashes on the departure lanes may increase as the vehicles turning onto the crossroad merge with the vehicles already on the road.

Higher speeds and a possibly longer crossing distance and exposure could lead to an increase in crashes involving pedestrians, and the resulting crashes will likely have more serious consequences.

Safety benefits of right-turn channelization are shown in table 133.

Table 133. Safety benefits associated with right-turn channelization: Selected findings.

Treatment	Finding
Channelization ⁽¹³²⁾	25% decrease in all collisions. 50% decrease in right-turn collisions.

Operational Performance

Through vehicles will experience less delay if right-turning vehicles do not have to decelerate in a through lane. If the volume of right turns is significant enough that the right turn is the critical movement on an approach, provision of a right-turn roadway may increase capacity enough that more green time can be provided for other movements.

Multimodal Impacts

Curbed islands offer a refuge for pedestrians. Crossing paths should be clearly delineated, and the island itself should be made as visible as possible to passing motorists.

Right-turn roadways can reduce the safety of pedestrian crossings if an area is not provided for pedestrian refuge. Crossing distances are increased, as is pedestrian exposure to traffic. Elderly and mobility-impaired pedestrians may have difficulty crossing intersections with large corner radii. Right-turn channelization also makes it more difficult for pedestrians to cross the intersection safely, adequately see oncoming traffic that is turning right, and know where to cross. Proper delineation of the turning roadway may help, particularly at night.

Larger turn radii result in higher vehicle speeds. In areas with significant pedestrian traffic, consideration should be given to minimizing the curb radii while still accommodating the turning path of the design vehicle. Minimizing the curb radii will reduce vehicular turning speeds, minimize pedestrian crossing distances, and reduce the potential severity of vehicle-pedestrian collisions.

Socioeconomic Impacts

Access to adjacent properties may need to be restricted to provide a merge area. Owners of adjacent property should be involved in early discussions regarding the plans.

Summary

Table 134 summarizes the issues associated with channelized right-turn lanes.

Table 134. Summary of issues for channelized right-turn lanes.

Characteristics	Potential Benefits	Potential Liabilities
Safety	Separation of decelerating right-turn vehicles.	Potential for sideswipes and rear-end collisions on departure leg.
Operations	Higher right-turn capacity. Shorter green time. Less delay for following through vehicles.	None identified.
Multimodal	Pedestrian refuge area.	Longer pedestrian crossing distance and exposure. Higher vehicle speeds.
Physical	None identified.	Larger intersection footprint.
Socioeconomic	None identified.	Right-of-way costs. Access restrictions to property.
Enforcement, Education, and Maintenance	None identified.	None identified.

12.4 VARIABLE LANE USE TREATMENTS

12.4.1 Provide Reversible Lanes

Reversible lanes are used along a section of roadway to increase capacity without additional widening when flows during peak periods are highly directional. These peak periods could be regular occurrences, as with normal weekday morning and evening peak traffic, or with special events, as with roadways near major sporting venues. Reversible lanes often extend for a considerable length of an arterial through multiple signalized intersections.

According to the MUTCD, reversible lanes are governed by signs (section 2B.25) and/or the following lane use control signals (section 4J.02):⁽¹⁾

- DOWNWARD GREEN ARROW.
- YELLOW X.
- WHITE TWO-WAY LEFT-TURN ARROW.
- WHITE ONE-WAY LEFT-TURN ARROW.
- RED X.

At least three sources provide good information on the implementation of reversible lanes. First, the MUTCD provides guidance on the allowable applications of these lane use control signs and signals, as well as when lane use signals should be used instead of signs. Second, the *Traffic Control Devices Handbook* provides additional information on signal control transition logic that can be used when reversing the directional flow of a lane or changing a lane to or from two-way left-turn operation.⁽⁶¹⁾ Third, the *Traffic Safety Toolbox* provides further discussion on planning and implementation considerations, in addition to a discussion of the effects on capacity and safety.⁽⁹⁵⁾

Safety Performance

Reversible lanes help reduce congestion and thus are likely to reduce rear-end collisions. As reported in the *Traffic Safety Toolbox*, “Studies of a variety of locations where reversible lanes have been implemented have found no unusual problem with head-on collisions compared to other urban facilities. Typically, the reversible lanes will have either no effect on safety conditions or will achieve small but statistically significant reductions in accident rates on the facility.”^(95, p. 130)

Reversible lanes may preclude the use of median treatments as an access- management technique along an arterial street.

Operational Performance

Reversible lanes directly benefit operational performance by allowing better matching of the available right-of-way to peak direction demands.

Multimodal Impacts

The operation of a reversible lane precludes the use of a fixed median to physically separate opposing travel directions. Therefore, reversible lane operation precludes the use of medians as a refuge area for pedestrians, thus requiring pedestrians to cross the arterial in one stage.

Physical Impacts

Reversible lanes may postpone or eliminate the need to widen a facility.

Socioeconomic Impacts

Reversible lanes are a relatively low-cost treatment compared to the cost of physically widening a facility.

Summary

Table 135 summarizes of the issues associated with reversible lanes.

Table 135. Summary of issues for reversible lanes.

Characteristics	Potential Benefits	Potential Liabilities
Safety	Typically achieves small but statistically significant accident reductions due to reduced congestion.	May preclude access management techniques.
Operations	Provides additional capacity to accommodate peak direction flows.	None identified.
Multimodal	None identified.	Reversible lanes may prevent the use of median pedestrian refuges.
Physical	May postpone or eliminate the need to widen a facility.	None identified.
Socioeconomic	Relatively low cost.	None identified.
Enforcement, Education, and Maintenance	None identified.	None identified.

12.4.2 Provide Variable Lane Use Assignments

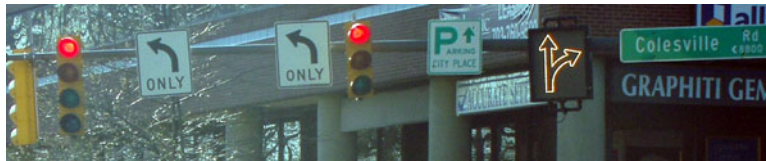
The concept of variable lane use treatments at signalized intersections is similar to that of the reversible lane but is typically applied locally to a single intersection. Variable treatments change individual lane assignments at a signalized intersection by time of day and thus can be used to accommodate turning movements with highly directional peaking characteristics.

Issues to consider when implementing variable lane use signs include:⁽⁵⁰⁾

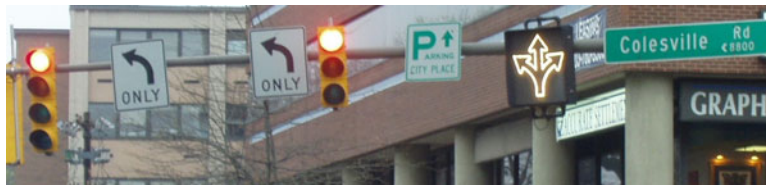
- Adequate turning radius for the number of turning lanes intended during each mode of operation.
- Adequate receiving lanes for each mode of operation.
- Compatible signal phasing to accommodate each lane configuration.
- The use of similar variable advance lane use signs to provide adequate notice to drivers of the lane use in effect.

Signal phasing requires special attention when using variable lane use signs. While not necessary for all variable lane use operations, split phasing allows any legal combination of lanes to be implemented, provided that the other factors cited above are accommodated. Other techniques that could be used include variable left-turn phasing treatments (e.g., protected-only operation during some times of day, and protected-permissive operation during others).

Figures 125 and 126 provide examples from Montgomery County, MD, where variable lane use signs have been provided for additional left and right turns, respectively. These signs have been employed in conjunction with advance variable lane use signs provided several hundred feet before the intersection. The signs are compliant with the MUTCD, which allows changeable message signs to use the reverse color pattern when displaying regulatory messages (sections 2A.07 and 6F.52).⁽¹⁾ They are reported as being well received by the public and effective in reducing peak-period queuing.⁽⁵⁰⁾



(a) Double left turn during morning peak and off-peak periods.



(b) Triple left turn during evening peak period.

Figure 125. Example use of variable lane use sign to add a third left-turn lane during certain times of day.



Figure 126. Example use of variable lane use sign to add a second right-turn lane along a corridor during certain times of day.

Summary

Table 136 summarizes the issues associated with variable lane use.

Table 136. Summary of issues for variable lane use.

Characteristics	Potential Benefits	Potential Liabilities
Safety	None identified.	None identified.
Operations	Improved peak-period utilization of existing right-of-way. Reduced queuing during peak periods.	None identified.
Multimodal	None identified.	None identified.
Physical	Reduces or eliminates need for additional right-of-way.	None identified.
Socioeconomic	Lower cost than adding lanes.	None identified.
Enforcement, Education, and Maintenance	None identified.	None identified.

REFERENCES

1. Federal Highway Administration (FHWA). *Manual on Uniform Traffic Control Devices*. Washington, DC: U.S. Department of Transportation (USDOT), FHWA, 2003.
2. Transportation Research Board (TRB). *Highway Capacity Manual 2000*. Washington, DC: TRB, National Research Council (NRC), 2000.
3. American Association of State Highway and Transportation Officials (AASHTO). *A Policy on Geometric Design of Highways and Streets*. Washington, DC: AASHTO, 2001.
4. National Highway Traffic Safety Administration (NHTSA). *Traffic Safety Facts 2002: A Compilation of Motor Vehicle Crash Data from the Fatality Analysis Reporting System and the General Estimates System*. Washington, DC: USDOT, NHTSA, 2003.
5. FHWA. Safety and Operations Electronic Reading Room. <http://www.fhwa.dot.gov/tfhrc/safety/intro.htm>. Accessed May 2004.
6. Robinson, B.W., L. Rodegerdts, W. Scarbrough, W. Kittelson, R. Troutbeck, W. Brilon, L. Bondzio, K. Courage, M. Kyte, J. Mason, A. Flannery, E. Myers, J. Bunker, and G. Jacquemart. *Roundabouts: An Informational Guide*. Report No. FHWA-RD-00-067. Washington, DC: USDOT, FHWA, June 2000.
7. Americans with Disabilities Act (ADA). Public Law 226, 101st Congress. July 26, 1990.
8. Alexander, G. J., and H. Lunenfeld. *Driver Expectancy in Highway Design and Operations*. Report No. FHWA-TO-86-1. Washington, DC: USDOT, FHWA, May 1986.
9. Institute for Transportation Engineers (ITE). *Traffic Safety Toolbox: A Primer on Traffic Safety*. Washington, DC: ITE. 1993.
10. Smiley, A., C. MacGreger, and R. Dewar. *Evaluation of Prototype Highway Tourist Signs for Ontario*. Prepared by Human Factors North for the Ontario Ministry of Transportation, Research and Development Branch. Ontario, Canada: June 1996.
11. Treat, J., N. Tumbas, S. McDonald, D. Shinar, R. Hume, R. Mayer, R. Stansfin, and N. Castellen. *Tri-level Study of the Causes of Traffic Accidents*. Report No. DOT-HS-034-3-535-77 (TAC), Indiana, 1977.
12. Staplin, L., K. Lococo, S. Byington, and D. Harkey. *Highway Design Handbook for Older Drivers and Pedestrians*. Report No. FHWA-RD-01-103. Washington, DC: USDOT, FHWA, 2001.
13. Alicandri, E. "Human Factors and Highway Safety," Intersection Safety Workshop, Milwaukee, WI, November 14-16, 2001.
14. Insurance Institute for Highway Safety, Fatality Facts, Passenger Vehicles http://www.highwaysafety.org/safety_facts/fatality_facts/passenger_vehicles.pdf. Accessed September 2002.
15. Insurance Institute for Highway Safety, Fatality Facts, Large Trucks http://www.highwaysafety.org/safety_facts/fatality_facts/large_trucks.pdf. Accessed September 2002.
16. Bureau of Transportation Statistics (www.bts.gov), 2002.
17. Bureau of Transportation Statistics (www.bts.gov), 2001.
18. Highway Safety Information System (HSIS). California database, 1994-1998.

19. Mohamedshad, Y., L. Chen, and F. Council. *Association of Selected Intersection Factors with Red-Light-Running Crashes*. Report No. FHWA-RD-00-12. Washington, DC: USDOT, FHWA, 2000.
20. Stutts, J., D. Reinfurt, L. Staplin, and E. Rodgman. *The Role of Driver Distraction in Traffic Crashes*. Prepared for American Automobile Association Foundation for Traffic Safety, 2001.
21. AASHTO. *Guide for the Development of Bicycle Facilities*. Washington, DC: AASHTO, 1999.
22. FHWA. *Selecting Roadway Design Treatments to Accommodate Bicycles*. Report No. FHWA-RD-92-073. Washington, DC: USDOT, FHWA, January 1994.
23. Pein, W. E. *Trail Intersection Design Guidelines*. Prepared for State Bicycle/Pedestrian Program, State Safety Office, Florida Department of Transportation. Highway Safety Research Center, University of North Carolina. September 1996.
24. Danish Road Directorate. *Collection of Cycle Concepts*. Copenhagen, Denmark: Road Directorate: 2000.
25. NHTSA. *Traffic Safety Facts 2001: Pedalcyclists*. <http://www-nrd.nhtsa.dot.gov/pdf/nrd-30/ncsa/tsf2001/2001pedal.pdf>. 2001.
26. FHWA. *Injuries to Pedestrians and Bicyclists: An Analysis Based on Hospital Emergency Department Data*. Report No. FHWA-RD-99-078. Washington, DC: USDOT, FHWA, 1999.
27. FHWA. *Pedestrian and Bicycle Crash Types of the Early 1990s*. Report No. FHWA-RD-95-163. Washington, DC: USDOT, FHWA, 1995.
28. Geary, R. R. "U.S. Bicycle Traffic Fatalities: Trends and Characteristics." Presented at Vélo Mondial 2000, The Versatile Approach, Amsterdam, The Netherlands, June 19-22, 2000. <http://www.velomondial.net/velomondial2000/>.
29. Tomlinson, D. "Conflicts between cyclists and motorists in Toronto, Canada." Presented at Vélo Mondial 2000, The Versatile Approach, Amsterdam, The Netherlands, June 19-22, 2000. <http://www.velomondial.net/velomondial2000/>.
30. Ho, G; and S. Hemsing. "A Review of Motor Vehicle-Bicycle Collisions in British Columbia." ITE Joint Conference, 1997.
31. USDOT. *Nationwide Personal Transportation Survey*, <http://nhts.ornl.gov/2001/index.shtml>. 2001.
32. Fruin, J. J. *Pedestrian Planning and Design*. New York: Metro Association of Urban Designers and Environmental Planning, 1971.
33. U.S. Architectural and Transportation Barriers Compliance Board (U.S. Access Board). *Americans with Disabilities Act Accessibility Guidelines for Buildings and Facilities (ADAAG)*. 36 CFR Part 1191. As amended through September 2002.
34. Kirschbaum, J. B., P. W. Axelson, P.E. Longmuir, K. M. Mispagel, J. A. Stein, and D. A. Yamada. *Designing Sidewalks and Trails for Access, Part II of II: Best Practices Design Guide*. Report No. FHWA-EP-01-127. Washington, DC: USDOT, FHWA, September 2001.
35. Zegeer, C.V., C. Seiderman, P. Lagerway, M. Cynecki, M. Ronkin, and R. Schneider. *Pedestrian Facilities Users Guide—Providing Safety and Mobility*. Report No. FHWA-RD-01-102. Washington, DC: USDOT, FHWA, 2002.
36. National Center for Statistics and Analysis (NCSA). *Pedestrian Roadway Fatalities*. USDOT, NCSA, April 2003.

37. Leaf, W.A., and D.F. Preusser. *Literature Review on Vehicle Travel Speeds and Pedestrian Injuries*. Report No. DOT-HS-809-021. Washington, DC: USDOT, NHTSA, October 1999.
38. Florida Department of Transportation, *Florida Pedestrian Planning and Design Handbook*, April 1999.
39. Taoka, G.T. "Statistical Evaluation of Brake Reaction Time," *Compendium of Technical Papers*, 52nd Annual Meeting of ITE, Chicago, IL, pp. 30-36, August 1982.
40. Hooper, K. and McGee, H. "Driver Perception-Reaction Time: Are Revisions to Current Specification Values in Order?" *Transportation Research Record 904*, pp. 21-30, 1983.
41. Neuman, T.R. NCHRP Report 279: *Intersection Channelization Design Guide*. National Cooperative Highway Research Program (NCHRP), TRB, NRC. Washington, DC: National Academy Press, 1985.
42. Woodson, W.E., B. Tillman, and P. Tillman. *Human Factors Design Handbook: Information and Guidelines for the Design of Systems, Facilities, Equipment, and Products for Human Use*, Second Edition. New York: McGraw-Hill, Inc., 1992.
43. Gattis, J. L., and S. T. Low. *Intersection Angle Geometry and the Driver's Field of View*. Final Technical Report 1073. University of Arkansas, 38 pp., March 1998.
44. U.S. Architectural and Transportation Barriers Compliance Board (U.S. Access Board). *Draft Guidelines on Accessible Public Rights-of-Way*. <http://www.access-board.gov/rowdraft.htm>. June 17, 2002.
45. U.S. Architectural and Transportation Barriers Compliance Board (U.S. Access Board), Public Rights-of-Way Access Advisory Committee. *Building a True Community*. <http://www.access-board.gov/prowac/commrept/index.htm>. January 2001.
46. University of North Carolina Highway Safety Research Center. *Florida Pedestrian Planning and Design Handbook*. Prepared for the Florida Department of Transportation. April 1999.
47. City of Portland (Oregon). *City of Portland Pedestrian Design Guide*. Portland, OR: Office of Transportation, June 1998.
48. Seymour, E., J. Green, and J. Black. "The Permitted Lead-Lag Left-Turn Display." In *1994 Compendium of Technical Papers*, ITE, 64th Annual Meeting, La Jolla, CA, 1994.
49. Brehmer, C., K. Kacir, D. Noyce, and M. Manser. *NCHRP Report 493: Evaluation of Traffic Signal Displays for Protected/Permissive Left-turn Control*. NCHRP, TRB, NRC. Washington, DC: National Academies Press, 2003.
50. Wainwright, W.S. "Tricks of the Trade: How to Get More Capacity at Your Signalized Intersections, at Low Cost and Without Compromising Safety." In *2003 Annual Meeting and Exhibit, CD Compendium*, ITE, 73rd Annual Meeting, Seattle, WA, August 24-27, 2003.
51. Bentzen, B.L., and L.S. Tabor. *Accessible Pedestrian Signals*. Document A-37. <http://www.access-board.gov/research&training/pedsignals/pedestrian.htm>. Washington, DC: U.S. Architectural and Transportation Barriers Compliance Board (U.S. Access Board), 1998.
52. Barlow, J.M., B.L. Bentzen, and L.S. Tabor. "Accessible Pedestrian Signals: Synthesis and Guide to Best Practice." *Research Results Digest Number 278*. http://gulliver.trb.org/publications/nchrp/nchrp_rrd_278.pdf. Washington, DC: NCHRP, July 2003. Also available online at <http://www.walkinginfo.org/aps/>.
53. Noyce, D.A., and J.M. Barlow. *Interfacing Accessible Pedestrian Signals (APS) with Traffic Signal Control Equipment*. <http://www.access-board.gov/research&training/APS/report.htm>.

- Washington, DC: U.S. Architectural and Transportation Barriers Compliance Board (U.S. Access Board), April 2003.
54. American Association of State Highway Transportation Officials (AASHTO). *Roadside Design Guide*. Washington, DC: AASHTO, 2002.
 55. FHWA. *Traffic Detector Handbook*, (final draft). Washington, DC: USDOT, FHWA, 2003.
 56. Kell, J.H., and I.J. Fullerton. *Manual of Traffic Signal Design*, 2nd edition. Washington, DC: ITE, 1998.
 57. FHWA. *Traffic Control Devices Handbook*. Washington, DC: FHWA, 1983.
 58. Bonneson, J.A., and P.T. McCoy. *Manual of Traffic Detector Design*, 1st edition. Washington, DC: ITE, 1994.
 59. Wortman, R.H., and T.C. Fox. "A Reassessment of the Traffic Signal Change Interval." In *Transportation Research Record 1069*. Washington, DC: TRB, NRC, 1986.
 60. ITE. *Making Intersections Safer: A Toolbox of Engineering Countermeasures to Reduce Red-Light Running*. Washington, DC: ITE, 2003.
 61. ITE. *Traffic Control Devices Handbook*, J.L. Pline, editor. Washington, DC: ITE, 2001.
 62. ITE. *Traffic Signing Handbook*. Washington, DC: ITE, 1997.
 63. Illuminating Engineering Society of North America (IESNA). *American National Standard Practice for Roadway Lighting*. Standard RP-8-00. June 2000.
 64. ITE. *Statistical Evaluation in Traffic Safety Studies*. Washington, DC: ITE, 1999.
 65. State Farm Insurance. "10 Most Dangerous Intersections and Photos." As documented by Cable News Network. "List of 'most dangerous' intersections released." <http://www.cnn.com/2001/US/06/27/dangerous.intersections>. June 27, 2001.
 66. Alexander, G. *Positive Guidance in Maryland: Guidelines and Case Studies*, undated.
 67. Ho, G., S. Zein, and J. Nepomuceno. *Traffic Conflict Procedure Manual*, Second Edition. Vancouver, BC, Canada: G.D. Hamilton Associates Consulting Ltd., 1997.
 68. Washington State Department of Transportation (WSDOT). *Local Agency Safety Management System*. Olympia, WA: WSDOT, September 2000.
 69. De Leur, P, and T. Sayed. "Developing a Systematic Framework for Proactive Safety Planning." *Proceedings for the 81st TRB Annual Meeting*. Washington, DC: TRB, 2002.
 70. Akçelik, R. and M. Besley. *aaSIDRA User Guide*. Greythorn, Victoria, Australia: Akçelik & Associates Pty Ltd., February 2002.
 71. Teply, S., D.I. Allingham, D.B. Richardson, and B.W. Stephenson. *Canadian Capacity Guide for Signalized Intersections*, 2nd edition. S. Teply, ed. ITE, District 7—Canada. Washington, DC: ITE, June 1995.
 72. Peterson, B.E., A. Hansson, and K.L. Bang. *CAPCAL 2—Model Description of Intersection with Signal Control*. Borlänge, Sweden: Swedish National Road Administration, 1995.
 73. TRB. *Highway Capacity Manual*, Special Report 209. Washington, DC: TRB, 1985.
 74. Chang, G.L, and Joseph, J. *Empirical Investigation of Intersection Traffic Patterns Under Maryland Driving Populations—Analysis of the Critical-Lane Volume Method at Signalized Intersections*. College Park, MD: The University of Maryland at College Park. August 2001.
 75. TRB. *TCRP Report 100: Transit Capacity and Quality of Service Manual*, 2nd edition. Washington, DC: TRB, 2004.

76. TRB. *Transportation Research Circular 212: Interim Materials on Highway Capacity*. Washington, DC: TRB, 1980.
77. TRB. *Highway Capacity Manual*, Special Report 209, 1994 update. Washington, DC: TRB, 1994.
78. TRB. *Highway Capacity Manual*, Special Report 209, 1997 update. Washington, DC: TRB, 1997.
79. Harwood, D.W., M.T. Pietrucha, M.D. Wooldridge, R.E. Brydia, and K. Fitzpatrick. *NCHRP Report 375: Median Intersection Design*. NCHRP, TRB, NRC. Washington, DC: National Academy Press, 1995.
80. Radwan, A.E., K.C. Sinha, and H.L. Michael. *Development and Use of a Computer Simulation Model for the Evaluation of Design and Control Alternatives for Intersections of Minor Roads with Multilane Rural Highways*. Report Nos. FHWA-IN-79/8, FHWA-IN-79/9, and FHWA-IN-79/10. Joint Highway Research Project. West Lafayette, IN: Purdue University, July 1979.
81. Priest, R.V. "Statistical Relationships Between Traffic Volume, Median Width, and Accident Frequency on Divided Highway Grade Intersections." *Highway Research News*, No. 13. Washington, DC: Highway Research Board, NRC, June 1964.
82. Castronovo, S., P.W. Dorothy, and T.L. Maleck. "Investigation of the Effectiveness of Boulevard Roadways." In *Transportation Research Record 1635*. Washington, DC: TRB, NRC, 1998.
83. Dorothy, P.W., T.L. Maleck, and S.E. Nolf. "Operational Aspects of Michigan Design for Divided Highways." In *Transportation Research Record 1579*. Washington, DC: TRB, NRC, 1997.
84. FHWA. *Vegetation Control for Safety: A Guide for Street and Highway Maintenance Personnel*. Report No. FHWA-RT-90-003. Washington, DC: FHWA, 1990.
85. Gluck, J., H.S. Levinson, and V.G. Stover. *NCHRP Report 420: Impacts of Access Management Techniques*. NCHRP, TRB, NRC. Washington, DC: National Academy Press, 1999.
86. ITE. *Transportation and Land Development*, 2nd Edition. Washington, DC: ITE, 2002.
87. TRB. *Access Management Manual*. Washington, DC: TRB, 2003.
88. Xu, L. "Right Turns Followed by U-Turns vs. Direct Left Turns: A Comparison of Safety Issues." *ITE Journal*, November 2001, pp. 36-43.
89. Papayannoulis, V., J.S. Gluck, K. Feeney, and H.S. Levinson. "Access Spacing and Traffic Safety." In *Transportation Research Circular E-C019: Urban Street Symposium Conference Proceedings*, Dallas, TX, June 28-30, 1999. Washington, DC: TRB, NRC, December 2000.
90. McLean, J. *Transport Research Report 315: Practical Relationships for the Assessment of Road Feature Treatments*. Summary Report. Australian Road Research Board, 1997.
91. Colorado Department of Transportation. *Colorado Access Control Demonstration Project: Final Report*. Denver, CO: Colorado Department of Transportation, June 1985.
92. Maze, T., D. Plazak, P. Chao, J. K. Evans, E. Padgett, and J. Witmer. *Access Management Research and Awareness Program, Phase IV Final Report*. CTRE Management Project 97-1, November 1999.
93. McCoy, P.T., and J.E. Heimann. "Effect of Driveway Traffic on Saturation Flow Rates at Signalized Intersections." *ITE Journal*, February 1990, pp. 12-15.

94. Vargas, F.A., and Y. Gautam. "Problem: Roadway Safety vs. Commercial Development Access." In *1989 Compendium of Technical Papers*, ITE, 59th Annual Meeting, San Diego, CA. Washington, DC: ITE, 1989, pp. 46-50.
95. ITE. *The Traffic Safety Toolbox: A Primer on Traffic Safety*. Washington, DC: ITE, 1999.
96. Rakha, H., A. Medina, H. Sin, F. Dion, M. Van Aerde, and J. Jenq. "Traffic Signal Coordination Across Jurisdictional Boundaries: Field Evaluation of Efficiency, Energy, Environmental, and Safety Impacts." In *Transportation Research Record 1727*. Washington, DC: TRB, NRC, 2000.
97. Avgoustis, A. *Quantifying the Safety Impacts of Intelligent Transportation Systems*. Master of Engineering Thesis, Civil Engineering Department, Virginia Polytechnic Institute and State University, 1999
98. Southeast Michigan Council of Governments. *SEMCOG Traffic Safety Manual*, Third Edition. 1998
99. Colorado Department of Transportation. *Colorado Access Control Demonstration Project: Final Report*. Denver, CO: Colorado Department of Transportation, June 1985.
100. Collura, J., J. Chang, E.W. Willhaus, and J. Gifford. "Traffic Signal Preemption and Priority: Technologies, Past Deployments, and System Requirements." In *2001 ITS America Conference Proceedings*, Miami Beach, FL, 2001.
101. Zegeer, C.V., and C. Seiderman. "Designing for Pedestrians." In *2001 Compendium of Technical Papers*, ITE, 71st Annual Meeting, Chicago, IL. Washington, DC: ITE, 2001.
102. King, M. "Calming New York City Intersections." In *Transportation Research Circular E-C019: Urban Street Symposium Conference Proceedings*, Dallas, TX, June 28-30, 1999. Washington, DC: TRB, NRC, December 2000.
103. Retting, R.A., and R. Van Houten. "Safety Benefits of Advance Stop Lines at Signalized Intersections: Results of a Field Evaluation." *ITE Journal*, September 2000, pp. 47-49, 54.
104. Zegeer, C.V., and M.J. Cynecki. "Evaluation of Countermeasures Related to RTOR Accidents that Involve Pedestrians." In *Transportation Research Record 1059*. Washington, DC: TRB, NRC, 1986.
105. Lalani, N. and the ITE Pedestrian and Bicycle Task Force. *Alternative Treatments for At-Grade Pedestrian Crossings*. Washington, DC: ITE, 2001.
106. Lord, D., A. Smiley, and A. Haroun. "Pedestrian Accidents with Left-Turning Traffic at Signalized Intersections: Characteristics, Human Factors and Unconsidered Issues." Presented at TRB 77th Annual Meeting, 1998.
107. Zaidel, D.M., and I. Hocherman. "Safety of Pedestrian Crossings at Signalized Intersections." In *Transportation Research Record 1141*. Washington, DC: TRB, NRC, 1987.
108. Barlow, J. "Making Intersections Accessible for the Visually Impaired." In *2001 Compendium of Technical Papers*, ITE, 71st Annual Meeting, Chicago, IL. Washington, DC: ITE, 2001.
109. Van Houten, R., J.E.L. Malenfant, J. Van Houten, and R.A. Retting. "Auditory Pedestrian Signals Increase Pedestrian Observing Behavior at Signalized Intersections." Presented at TRB 77th Annual Meeting, 1998.
110. Allsbrook, L. "Pedestrian Signal Countdown Device." In *1999 Compendium of Technical Papers*, ITE, 69th Annual Meeting, Las Vegas, NV. Washington, DC: ITE, 1999.
111. Chester, D.C., and M. Hammond. "Evaluation of Pedestrians Understanding of Pedestrians Countdown Signals." In *1998 Compendium of Technical Papers*, ITE, 68th Annual Meeting, Toronto, Ontario, Canada. Washington, DC: ITE, 1998.

112. Bernier, L. *Economic Evaluation of Implementing a New Signalization System: Digital Countdown Device*. Quebec, Canada: Project de Transports, 1996.
113. Van Houten, R., R.A. Retting, J. Van Houten, C.M. Farmer, and J.E.L. Malenfant. "Use of Animation in LED Pedestrian Signals to Improve Pedestrian Safety." *ITE Journal*, February 1999, pp. 30-38.
114. Jolibois, S., J. Guerrier, D. Ospina, T. Baker, and L. Hermantin. *Interventions to Promote Pedestrian Safety at Urban Intersections*. Report No. WPI-0510760, Final Report; State Job 99700-3314-010; FIU Project 57-18-225-00. Florida International University, June 1997.
115. Van Houten, R., R.A. Retting, C.M. Farmer, and J. Van Houten. "Field Evaluation of a Leading Pedestrian Internal Signal Phase at Three Urban Intersections." Presented at TRB 77th Annual Meeting, 1998.
116. Zegeer, C, K. Opiela, and M. Cynecki. *Pedestrian Signalization Alternatives*. Report No. FHWA-RD-83-102. Washington, DC: USDOT, FHWA, 1983.
117. New Jersey Department of Transportation. *Pedestrian Compatible—Planning and Design Guidelines*. Trenton, NJ: New Jersey Department of Transportation, 2001.
118. Herrstedt, L., M.A. Nielsen, L. Agustson, K.M.L. Krogsgaard, E. Jørgensen, and N.O. Jørgensen. *Safety of Cyclists in Urban Areas: Danish Experiences*. Copenhagen, Denmark: Danish Road Directorate, 1994.
119. Jensen, S.U., and M.A. Nielsen. "The Marking of Bicycle Crossings at Signalized Intersections" (in Danish). Summarized in *Nordic Road & Transport Research*, No. 1, 1997, p. 27.
120. Leden, L., P. Garder, and U. Pulkkinen. "Measuring the Safety Effect of Raised Bicycle Crossings Using a New Methodology." Presented at the 1998 TRB Annual Meeting, Washington, DC, 1998.
121. Texas Transportation Institute. *TCRP Report 19: Guidelines for the Location and Design of Bus Stops*. Transit Cooperative Research Program, TRB, NRC. Washington, DC: National Academy Press, 1996.
122. Park, Y, and W.C. Kloos. "Applicability of Countermeasures to Implement Farside Travel Lane Bus Stops Case Study: Lloyd District Transit Hub, Portland, Oregon." In *1998 Compendium of Technical Papers*, ITE, 68th Annual Meeting, Toronto, Ontario, Canada. Washington, DC: ITE, 1998.
123. New York State Department of Transportation. *Accident Reduction Factors*. <http://www.dot.state.ny.us/traffic/files/rftab95a.pdf>. Accessed September 2002.
124. Wortman, R.H. and T.C. Fox. Final Report: Optimization of Traffic Signal Change Intervals. Report Number ATTI-85-2. Phoenix, AZ: Arizona Department of Transportation, 1985.
125. Eccles, K.A., and H.W. McGee. *A History of the Yellow and All-Red Intervals for Traffic Signals*. Washington, DC: ITE, 2001.
126. Zador, P.L., H.S. Stein, S.R. Shapiro, and P.J. Tarnoff. "Effect of Clearance Interval Timing on Traffic Flow and Crashes at Signalized Intersections." *ITE Journal*, November 1985, pp. 36-39.
127. Retting, R.A., and M.A. Greene. "Influence of Traffic Signal Timing on Red-Light Running and Potential Vehicle Conflicts at Urban Intersections." In *Transportation Research Record 1595*. Washington, DC: TRB, NRC, 1997.
128. ITE. "Determining Vehicle Change Intervals: A Proposed Recommended Practice." *ITE Journal*, May 1985, pp. 61-64.

129. Retting, R.A., J. Chapline, and A. Williams. *Changes in Crash Risk Following Re-Timing of Traffic Signal Change Intervals*. Insurance Institute for Highway Safety, 2000.
130. Brewer, M., J. Bonneson, and K. Zimmerman. "Engineering Countermeasures to Red-Light-Running." Presented at ITE 2002 Spring Conference, Palm Harbor, FL, March 2002.
131. Schattler, K.L., C. Hill, and T.K. Datta. "Clearance Interval Design and Red Light Violations." Presented at ITE 2002 Spring Conference, Palm Harbor, FL, March 2002.
132. Agent, K., N. Stamatiadis, and S. Jones. *Development of Accident Reduction Factors*. Kentucky Highway Research Program, Research Report KTC-96-13. Lexington, KY: University of Kentucky, 1996.
133. Ontario Ministry of Transportation. *Ontario Traffic Manual Book 12—Traffic Signals*. Toronto, Ontario, Canada: Ontario Ministry of Transportation, July 2001.
134. Gaberty, M.J. II and J.C. Barbaresso. "A Case Study of the Accident Impacts of Flashing Signal Operations Along Roadways." *ITE Journal*, July 1987, pp. 27-28.
135. Polanis, S. "Improving Intersection Safety Through Design and Operations." Presented at ITE 2002 Spring Conference, Palm Harbor, FL, March 2002.
136. Hasson, P., P. Lutkevich, B. Ananthanarayanan, P. Watson, and R. Knoblauch. "Field Test for Lighting to Improve Safety at Pedestrian Crosswalks." Presented at the 2004 TRB Annual Meeting, Washington, DC, 2004.
137. Ogden, K.W. *Safer Roads: A Guide to Road Safety Engineering*. Hampshire, England: Averbury Technical Press, 1996.
138. Mucsi, K., and A.M. Khan. "Effectiveness of Additional Lanes at Signalized Intersections." *ITE Journal*, January 2003, pp. 26-30.
139. Hanna, J.T., T.E. Flynn, and W.K. Tyler. "Characteristics of Intersection Accidents in Rural Municipalities." In *Transportation Research Record 601*. Washington, DC: TRB, NRC, 1976.
140. Department of Transport and Roads (Australia). Web page, www.dotars.gov.au/transprog/downloads/road_bs_matrix.pdf, Accessed September 2002.
141. Hummer, J.E., and J.D. Reid. "Unconventional Left-Turn Alternatives for Urban and Suburban Arterials: An Update." In *Transportation Research Circular E-C019: Urban Street Symposium Conference Proceedings*, Dallas, TX, June 28-30, 1999. Washington, DC: TRB, NRC, December 2000.
142. Hummer, J.E. "Unconventional Left-Turn Alternatives for Urban and Suburban Arterials—Part One." *ITE Journal*, September 1998, pp. 26-29.
143. Hummer, J.E. "Unconventional Left-Turn Alternatives for Urban and Suburban Arterials—Part Two." *ITE Journal on the Web* (accessed October 2003), <http://www.ite.org/membersonly/itejournal/pdf/JKA98B01.pdf> (access restricted to ITE members). November 1998, pp. 101-106.
144. New Jersey Department of Transportation. *Highway Design Manual*. <http://www.state.nj.us/transportation/cpm/RDMEnglish/>. Accessed October 2003.
145. Reid, J.D., and J.E. Hummer. "Travel Time Comparisons Between Seven Unconventional Arterial Intersection Designs." In *Transportation Research Record 1751*. Washington, DC: TRB, NRC, 2001.
146. Boone, J.L., and J.E. Hummer. *Unconventional Design and Operation Strategies for Oversaturated Major Suburban Arterials: Final Report*. Project 23241-93-9. North Carolina State University, Department of Civil Engineering, Center for Transportation Engineering Studies, April 1995.

147. Michigan Department of Transportation. *Bureau of Highways Design Guide for Crossovers*. <http://www.mdot.state.mi.us/tands/plans.cfm>. Accessed October 2003.
148. Bared, J.G., and E.I. Kaisar. "Median U-Turns Design as an Alternative Treatment for Left Turns at Signalized Intersections." *ITE Journal*, February 2002, pp. 50-54.
149. Reid, J.D., and J.E. Hummer. "Analyzing System Travel Time in Arterial Corridors with Unconventional Designs Using Microscopic Simulation." In *Transportation Research Record 1678*. Washington, DC: TRB, NRC, 1999.
150. Jagannathan, R., and J.G. Bared. "Design and Operational Performance of the Crossover Displaced Left-Turn (XDL) Intersection (Also Called Continuous Flow Intersection (CFI))." Presented at the 2004 TRB Annual Meeting, Washington, DC, 2004.
151. Fuess, M., C. Cadena, D. Szplett, and F. Mier. "Development and Application of an Intelligent Intersection: A Summary of the Benefits and Drawbacks." Unpublished paper.
152. Goldblatt, R., F. Mier, and J. Friedman. "Continuous Flow Intersections." *ITE Journal*, July 1994, pp. 35-42.
153. Abramson, P., C. Bergen, and R. Goldblatt. "Human Factors Study of the Continuous Flow Intersection at the Dowling College National Aviation and Transportation Center." Presented at Dowling College Transportation Symposium, Summer 1995.
154. Reid, J.D. "Using Quadrant Roadways to Improve Arterial Intersection Operations." *ITE Journal*, June 2000, pp. 34-36, 43-45.
155. Kramer, R.P. "New Combinations of Old Techniques to Rejuvenate Jammed Suburban Arterials." Strategies to Alleviate Traffic Congestion, Proceedings of the ITE's 1987 National Conference, ITE, Washington, DC, 1988.
156. Bared, J.G., and E.I. Kaisar. "Benefits of Split Intersections." In *Transportation Research Record 1737*. Washington, DC: TRB, NRC, 2000.
157. Polus, A. and R. Cohen. "Operational Impact of Split Intersections." In *Transportation Research Record 1579*. Washington, DC: TRB, NRC, 1997.
158. Bared, J.G., A. Powell, and E. Kaisar. "Traffic Planning Models for Single-point and Tight Diamond Interchanges." TRB Paper No. 03-3736. Presented at the 2003 TRB Annual Meeting, Washington, DC
159. Smith, M.J. and N.J. Garber. "Guidelines for Selecting Single-Point Urban and Diamond Interchanges: Nationwide Survey and Literature Review." In *Transportation Research Record 1612*. Washington, DC: TRB, NRC, 1998.
160. Leisch, J.P., T. Urbanik II, and J.P. Oxley. "A Comparison of Two Diamond Interchange Forms in Urban Areas." *ITE Journal*, May 1989, pp. 21-27.
161. Messer, C.J., J.A. Bonneson, S.D. Anderson, and W.F. McFarland. *NCHRP Report 345: Single-Point Urban Interchange Design and Operations Analysis*. NCHRP, TRB, NRC. Washington, DC: National Academy Press, December 1991.
162. Fowler, B.C. "An Operational Comparison of the Single-Point Urban and Tight-Diamond Interchanges." *ITE Journal*, April 1993, pp. 19-24.
163. Selinger, M.J., and W.H. Sharp. "Comparison of SPUI and TUDI Interchange Alternatives with Computer Simulation Modeling." In *2000 Compendium of Technical Papers*, ITE, 70th Annual Meeting, Nashville, TN. Washington, DC: ITE, 2000.
164. Bonneson, J.A., and S. Lee. "A Technique for Comparing the Operation of Alternative Interchange Types." TRB Paper Number 02-2090. Presented at the 2002 TRB Annual Meeting, Washington, DC, 2002.

165. Bhesania, R.P. "Impact of Mast-Mounted Signal Heads on Accident Reduction." *ITE Journal*, October 1991, p. 25-29.
166. Voss, L. "Accident Reduction Factors." *Missouri Valley Section Institute of Traffic Engineers (MOVITE) Journal*, Volume 38, No. 2, 1997.
167. Sayed, T., W. Abdelwahab, and J. Nepomuceno. "Safety Evaluation of Alternative Signal Head Design." In *Transportation Research Record 1635*. Washington, DC: TRB, NRC, 1998.
168. G.D. Hamilton Associates Consulting Ltd. *Safety Benefits of Additional Primary Signal Heads*. Vancouver, BC, Canada: G.D. Hamilton Associates Consulting Ltd., 1998.
169. Miska, E., P. de Leur, and T. Sayed. "Road Safety Performance Associated with Improved Traffic Signal Design and Increased Signal Conspicuity." In *2002 Compendium of Technical Papers*, ITE, 72nd Annual Meeting, Philadelphia, PA. Washington, DC: ITE, 2002.
170. Sayed, T., H. Vahidi, and F. Rodriguez. "Advance Warning Flashers: Do They Improve Safety?" In *Transportation Research Record 1692*. Washington, DC: TRB, NRC, 1999.
171. Farraher, B.A., B.R. Weinholzer, and M.P. Kowski. "The Effect of Advanced Warning Flashers on Red Light Running: A Study Using Motion Imaging Recording System Technology at Trunk Highway 169 and Pioneer Trail in Bloomington, Minnesota." In *1999 Compendium of Technical Papers*, ITE, 69th Annual Meeting, Las Vegas, NV. Washington, DC: ITE, 1999.
172. Minnesota Department of Transportation. *2001 Solicitation for Federal Transportation Funding*, Hazard Elimination Safety Program. June 2001.
173. Teply, S. "Safety Implications of Advanced Flashing Amber at Signalized Intersections." Presented at Traffic Safety Summit in Alberta VII, Annual Western Canada Traffic Association Conference, October 4-7, 1998.
174. Laughland, J.C., L.E. Haefner, J.W. Hall, and D.R. Clough. *NCHRP Report 162: Methods for Evaluating Highway Safety Improvements*. NCHRP, TRB, NRC. Washington, DC: National Academy Press, 1975.
175. Schaerer, P. *Engineering Studies for Snow Removal*. Highway Research Board (HRB), Special Report 115. Washington, DC: HRB, 1970.
176. Hatcher, C. "Grooving streets and highways can help stop skid crashes" *Traffic Engineering*, April 1974.
177. Bray, J. "The Role of Crash Surveillance and Program Evaluation: NYSDOT's Skid Accident Reduction Program (SKARP)." Presented at 28th International Forum on Traffic Records and Highway Information Systems, Orlando, FL, 2002.
178. North Carolina Department of Transportation. "Safety Project Development Guide." http://www.doh.dot.state.nc.us/preconstruct/traffic/safety/project_guide/. Accessed September 2002.
179. California Department of Transportation. "Chapter 9—Hazard Elimination Safety Program." *Local Assistance Program Guidelines*. California Department of Transportation, 1997.
180. David, N.A., and J.R. Norman. *Motor Vehicle Accidents in Relation to Geometric and Traffic Features of Highway Intersections: Volume II—Research Report*. Report No. FHWA-RD-76-129. Washington, DC: USDOT, FHWA, July 1975.
181. FHWA. *The 1996 Annual Report on Highway Safety Improvement Programs*. Report No. FHWA-SA-96-040. Washington, DC: USDOT, FHWA, 1996.
182. Oregon Department of Transportation. *Highway Design Manual*. Salem, OR: Oregon Department of Transportation, 2003.

183. Harwood, D. *NCHRP Report 330: Effective Utilization of Street Width*. NCHRP, TRB, NRC. Washington, DC: TRB, August 1990.
184. McCoy, P.T., P.S. Byrd, and G. Pesti. *Pavement Markings to Improve Opposing Left-Turn Lane Sight Distance*. Nebraska Department of Roads Project No. STPP-STWD(36) and City of Lincoln Project No. 700791. Mid-America Transportation Center, University of Nebraska, Lincoln, NE, September 1999.
185. Malone, B. and G. Forbes. "Reducing Crashes in Multiple Turn Lanes on One-Way Streets." In *1999 Compendium of Technical Papers*, ITE, 69th Annual Meeting, Las Vegas, NV. Washington, DC: ITE, 1999.
186. Agent, K.R., N. Stamatiadis, and B. Dyer. *Guidelines for the Installation of Left-Turn Phasing*. Research Report KTC-95-23. Lexington, KY: Kentucky Transportation Center, December 1995.
187. Oregon Department of Transportation. *Traffic Signal Policy and Guidelines*. Salem, OR: Oregon Department of Transportation, November 19, 1999.
188. Harwood, D.W., K.M. Bauer, I.B. Potts, D.J. Torbic, K.R. Richard, E.R. Kohlman Rabbani, E. Hauer, and L. Elefteriadou. *Safety Effectiveness of Intersection Left- and Right-Turn Lanes*. Report No. FHWA-RD-02-089. Washington, DC: USDOT, FHWA, 2002.
189. Polanis, S.F. "Low Cost Safety Improvements—An Update." In *2001 Compendium of Technical Papers*, ITE, 71st Annual Meeting, Chicago, IL. Washington, DC: ITE, 2001.
190. Thomas, G., and D. Smith. *Effectiveness of Roadway Safety Improvements*. Center for Transportation Research and Education, 2001.
191. Ackeret, K.W. "Criteria for the Geometric Design of Triple Left-Turn Lanes." *ITE Journal*, December 1994, pp. 27-33.
192. Ackeret, K.W., S.S. Nambisan, and R. Menon. "Evaluation of Side Swipe Crashes at Triple and Dual Turn Lanes in Las Vegas, Nevada." In *1999 Compendium of Technical Papers*, ITE, 69th Annual Meeting, Las Vegas, NV. Washington, DC: ITE, 1999.
193. Belluccia, A.G., Harter, G.L., and Rechoric, M.J. "Triple Left-turn Lanes: Getting the First One Approved." In *1998 Compendium of Technical Papers*, ITE, 68th Annual Meeting, Toronto, Ontario, Canada. Washington, DC: ITE, 1998.
194. Nassi, R., Tucson, AZ. Telephone conversation, October 3, 2002.
195. Frederickson, J. Letter to the Arizona Insurance Information Association. October 2000.
196. Tarrall, M.B. and K.K. Dixon. "Conflict Analysis for Double Left-turn Lanes with Protected-Plus-Permitted Signal Phases." In *Transportation Research Record 1635*. Washington, DC: TRB, NRC, 1998.
197. Tsao, S. M., and S. W. Ando. "A Study on Adjustment Factors for U-Turns in Left-Turn Lanes at Signalized Intersections." In *Journal of Advanced Transportation*, Volume 29, Issue 2, August 1995, pp. 183-192.
198. Shebeeb, O. "Safety and Efficiency for Exclusive Left-Turn Lanes at Signalized Intersections." *ITE Journal*, July 1995, pp. 52-59.
199. Hurley, J.W. "Utilization of Auxiliary Through Lanes at Signalized Intersections." In *Transportation Research Record 1484*. Washington, DC: TRB, NRC, 1995.
200. Tarawneh, M.S. "Utilization of Auxiliary Through Lanes at Intersections of Four-Lane, Two-Way Roadways." In *Transportation Research Record 1737*. Washington, DC: TRB, NRC, 2000.
201. Washington State Department of Transportation (WSDOT). *Highway Design Manual*. Olympia, WA: Environmental and Engineering Services Center, WSDOT, September 2002.

202. Lin, F.-B. "Right-Turn-on-Red Characteristics and Use of Auxiliary Right-Turn Lanes." In *Transportation Research Record 1010*. Washington, DC: TRB, NRC, 1985.
203. Dixon, K.K., J.L. Hibbard, and H. Nyman. "Right-Turn Treatment for Signalized Intersections." In *Transportation Research Circular E-C019: Urban Street Symposium Conference Proceedings*, Dallas, TX, June 28-30, 1999.

BIBLIOGRAPHY (OTHER REFERENCES)

- Axelson, P.W., D.Y. Chesney, D.V. Galvan, J.B. Kirschbaum, P.E. Longmuir, C. Lyons, and K.M. Wong. *Designing Sidewalks and Trails for Access, Part I of II: Review of Existing Guidelines and Practices*. Available at <http://www.fhwa.dot.gov/environment/bikeped/access-1.htm>. Washington, DC: U.S. Department of Transportation (USDOT), Federal Highway Administration (FHWA), July 1999.
- Bonneson, J.A. and M.D. Fontaine. *NCHRP Report 457: Engineering Study Guide for Evaluating Intersection Improvements*. National Cooperative Highway Research Program, Transportation Research Board (TRB), National Research Council (NRC). Washington, DC: National Academy Press, 2001.
- Cairney, P. *Pedestrian Safety in Australia*. Report No. FHWA-RD-99-093. Washington, DC: USDOT, FHWA, December 1999.
- City of Toronto (Ontario, Canada) Transportation Services Works and Emergency Services Department. *Intersection Operational Safety Review Manual*. August 16, 2002.
- Cottrell, B.H., Jr. "Evaluation of Strobe Lights in Red Lens of Traffic Signals." In *Transportation Research Record 1495*. Washington, DC: TRB, NRC, 1995.
- Institute for Transportation Engineers (ITE). *Design and Safety of Pedestrian Facilities*. Washington, DC: ITE, March 1998.
- . *Traffic Engineering Handbook, 5th Edition*, J. L. Pline, editor. Washington, DC: ITE, 1999.
- Jones, T.L. and P. Tomcheck. "Pedestrian Accidents in Marked and Unmarked Crosswalks: A Quantitative Study." *ITE Journal*, September 2000, pp. 42-46.
- McCoy, P.T. and J.R. Tobin. "Use of Additional Through Lanes at Signalized Intersections." In *Transportation Research Record 869*. Washington, DC: TRB, NRC, 1982.
- Ontario (Canada) Ministry of Transportation. *Ontario Traffic Manual Book 1c: Positive Guidance Toolkit*. Toronto, Ontario, Canada: Ontario Ministry of Transportation, July 2001.
- . *The Science of Highway Safety: Network Evaluation and Safety Conscious Procedures*. Toronto, Ontario, Canada: Ontario Ministry of Transportation, 1999.
- Staplin, L., K. Lococo, and S. Byington. *Older Driver Highway Design Handbook*, Report No. FHWA-RD-97-135, McLean, VA: USDOT, FHWA, December 1998.
- Stover, V.G. "Access Control Issues Related to Urban Arterial Intersection Design." In *Transportation Research Record 1385*. Washington, DC: TRB, NRC, 1993.
- Styles, W.J. *Evaluation of the Flashing Red Strobe Signal*. Report No. FHWA/MD-83/07. Washington, DC: FHWA, June 1982.
- Synectics Transportation Consultants. *Comprehensive Road Safety Action Plan Safety Assessment/Safety Audit Manual*, June 2002.

SIGNALIZED INTERSECTIONS:

INFORMATIONAL GUIDE