



PDHonline Course C361 (6 PDH)

Airport Terminal Facilities Planning and Design

Instructor: Vincent D. Reynolds, MBA, PE

2020

PDH Online | PDH Center

5272 Meadow Estates Drive
Fairfax, VA 22030-6658
Phone: 703-988-0088
www.PDHonline.com

An Approved Continuing Education Provider



U.S. Department
of Transportation
Federal Aviation
Administration

Advisory Circular

/REPRINT INCLUDES CHANGE 1/

**Subject: PLANNING AND DESIGN
GUIDELINES FOR AIRPORT
TERMINAL FACILITIES**

**Date: 4/22/88
Initiated by: AAS- 100**

**AC No: 150/5360-13
change:**

-
1. **PURPOSE.** This advisory circular (AC) provides guidelines for the planning and design of airport terminal buildings and related access facilities. ,
 2. **CANCELLATION.** The following advisory circulars are canceled:
 - a. **AC 150/5360-6**, Airport Terminal Building Development with Federal Participation, dated October 5, 1976.
 - b. **AC 150/5360-7**, Planning and Design Considerations for Airport Terminal Building Development, dated October 5, 1976.
 3. **RELATED READING MATERIAL.** Appendix 1 contains a listing of documents with supplemental material relating to the planning and design of airport terminal facilities and how they may be obtained.

Leonard E. Mudd
Director, **Office** of Airport Standards

CONTENTS

CHAPTER 1. INITIAL PLANNING CONSIDERATIONS

1. Introduction.....	1	
2. Airport Master Plans.....	1	
3. Factors Influencing Terminal Configuration and Size.....	1	
4. Terminal Siting Considerations.....	3	
5. Project Coordination.....	4	
6.-19. Reserved.....	4	

CHAPTER 2. DESIGN METHODOLOGIES

20. General.....	7	
21. Forecasts.....	7	
22. Translating Forecasts to Peak Demands.....	7	
23. Peak Daily Activity.....	7	
24. Peak Hourly Activity.....	7	
25. Equivalent Aircraft (EQA) Factors.....	11	
26. Base Year Total Gate EQA.....	12	
27. Future Total Gate EQA.....	12	
28. EQA Arrivals.....	13	
29. Forecast Reasonability Checks.....	13	
30. Reserved.....	14	

CHAPTER 3. FUNCTIONAL RELATIONSHIPS AND TERMINAL CONCEPTS

31. Major Terminal Components.....	1	5
32. Functional Relationships of Terminal Components.....	16	
33. Objectives in Selecting Terminal Concepts.....	16	
34. Centralized and Unit Terminals.....	19	
35. Alternative Terminal Building Concepts.....	19	
36. Single-Level/Multilevel Terminals.....	23	
37. Terminal Concept Combinations and Variations.....	23	
38. Concept-Evaluation.....	25	
39.-40. Reserved.....	28	

CHAPTER 4. TERMINAL APRON AREAS

41. General.....	29	
42. Terminal Apron Gate Types.....	29	
43. Estimating Aircraft Gate Positions.....	29	
44. Gate Parking Procedures.....	30	
45. Aircraft Gate Clearances.....	30	
46. Taxilanes.....	36	
47. Apron Gradients.....	36	
48. Aircraft Parking Guidance Systems.....	36	
49. Loading Bridges.....	36	

50. Transporters	46
51. Fixed Utilities.....	48
52. Apron Area Lighting	48
53. Blast Fences	51
54.-65. Reserved	51

CHAPTER 5. TERMINAL BUILDING SPACE AND FACILITY GUIDELINES

66. General	53
67. Gross Terminal Building Area Estimates	53
68. Space Allocations	53
69. Public Lobby Areas	53
70. Airline Ticket Counter/Offices	58
71. Outbound Baggage Facilities	63
72. Public Corridors	74
73. Security Inspection Stations	75
74. Departure Lounges	77
75. Baggage Claim Facilities	79
76. Airline Operations Areas	84
77. Food and Beverage Services	89
78. Concessionaire and Building Services	90
79.-90. Reserved	91

CHAPTER 6. FEDERAL INSPECTION SERVICES (FIS) FACILITIES

91. General	95
92. Federal Inspection Services	95
93. Passenger Flow Sequence	95
94. Preclearance Facilities.....	96
95. General Design Considerations and Requirements	96
96. INS Requirements	100
97. USCS Requirements	100
98. PHS Requirements	101
99. APHIS Requirements	102
100. Joint FIS Employee Requirements	102
101. Space and Facility Requirements.....	103
102. Approval of FIS Facility Plans.....	103
103.-115. Reserved	103

CHAPTER 7. ACCESSIBILITY TO INDIVIDUALS WITH DISABILITIES AND SPECIAL NEEDS USERS

116. General	105
117. Minimum Building Design Standards	105
118. Specific Requirements for Airport Terminals	105
119. Existing Terminals	106
120. Other Users With Special Needs	106
121.-130. Reserved	106

CHAPTER 8. MISCELLANEOUS DESIGN CONSIDERATIONS

131. Airport Security	107
132. Architectural Treatment	108
133. Energy Conservation	108

134. Seismic Safety	109
135-145. Reserved	109

CHAPTER 9. AIRPORT ACCESS SYSTEMS

146. General	111
147. Planning Studies	111
148. Circulations System Configurations	111
149. Airport Roads	114
150. Terminal Curb Areas	120
151. Public Parking Facilities	121
152. Employee and Tenant Parking	122
153. Public Transportation and Rental Car Areas	123
154. Access System Signs	124
155. Transit System Links and Automated People Mover (APM) Systems	124
156.-160. Reserved	124

CHAPTER 10. FEDERAL PARTICIPATION IN THE COSTS OF TERMINAL DEVELOPMENT

161. General	125
162. Background	125
163. Financial Assistance	125
164. Special Requirements	125
165. Proration of Terminal Building Development Costs	125
166. Bond Retirement	125
167. Application of Federal Guidance	126
168.-170. Reserved	126

APPENDICES

Appendix 1.	Bibliography (2 pages)
Appendix 2.	Project Planning and Design (16 pages)
Appendix 3.	Federal Inspection Services Approval Offices (1 page)

FIGURES

Figure 1-1	Terminal Siting/Runway Configuration Relationships	5
Figure 1-2	Functional View of an Airport	6
Figure 2-1	Hypothetical Aircraft Schedule and Arriving Passenger/Visitor Population Plot	8
Figure 2-2	Percent of Daily Operations in Peak Hour vs Annual Enplaned Passengers	10
Figure 2-3	Percent of Daily Passengers in Peak Hour vs Annual Enplaned Passengers	10
Figure 2-4	Estimated Peak Hour Operations vs Annual Enplaned Passengers	11
Figure 3-1	Functional Adjacency Diagram	17
Figure 3-2	Functional Adjacency Matrix	18
Figure 3-3	The Linear Concept	20
Figure 3-4	The Pier Concept	21
Figure 3-5	The Satellite Concept	22
Figure 3-6	The Transporter Concept	24
Figure 3-7	Concept Combinations and Variations	26

Figure 3-8	Matrix of Concepts Related to Airport Size	27	
Figure 4-1	Enplanements Per Gate (10-Year Forecast - Low Utilization)	31	
Figure 4-2	Enplanements Per Gate (10-Year Forecast - High Utilization)	32	
Figure 4-3	Enplanements Per Gate (20-Year Forecast - Low Utilization)	3	3
Figure 4-4	Enplanements Per Gate (20-Year Forecast - High Utilization)	34	
Figure 4-5	Estimated Gate Positions vs Annual Enplaned Passengers	35	
Figure 4-6	Aircraft Maneuvering Area Taxi-Out Configuration	37	
Figure 4-7	Aircraft Maneuvering Area Taxi-Out Configuration	38	
Figure 4-8	Linear Configuration Pushout Gate Positioning	39	
Figure 4-9	Pier Configuration Pushout Gate Positioning	40	
Figure 4-10	Typical Clearances Inboard Pier Gate	41	
Figure 4-1 1	Satellite Configuration Pushout Gate Positioning	42	
Figure 4-1 2	Transporter Configuration Taxi-Through or Pushout Gate Positioning	43	
Figure 4-13	Dual- vs Single-Taxilane Layout	44	
Figure 4- 14	Typical Passenger Loading Bridges	45	
Figure 4- 15	Aircraft Sill Heights	47	
Figure 4- 16	Transporter Requirements	49	
Figure 4- 17	Common Fixed Utility Locations - Composite Aircraft Parking Envelope	50	
Figure 5-1	Gross Terminal Area Per Gate - Intermediate Planning	54	
Figure 5-2	Gross Terminal Area Per Gate - Long-Range Planning	54	
Figure 5-3	Gross Terminal Area Space Distribution	55	
Figure 5-4	Ticket Lobby and Counter Area	56	
Figure 5-5	Waiting Lobby Area	57	
Figure 5-6	Linear Counter	59	
Figure 5-7	Flow-Through Counter	60	
Figure 5-8	Island Counter	61	
Figure 5-9	Typical AT0 Layouts - Single-Level Terminals	62	
Figure 5- 10	Terminal Counter Frontage	64	
Figure 5- 11	AT0 Office and Support Space	65	
Figure 5-12	Outbound Baggage Area - Less than Five EQA	66	
Figure 5-13	Outbound Baggage Area - Five or More EQA	67	
Figure 5-14	Outbound Baggage Room Typical Raw Belt Conveyor Installation	69	
Figure 5-15	Outbound Baggage Recirculating Belt - Parallel Parking	70	
Figure 5-16	Outbound Baggage Recirculating Sloping Bed - Perpendicular Parking	71	
Figure 5-17	Semiautomated Linear Belt Sorter	71	
Figure 5- 18	Tilt-Tray Sorter	72	
Figure 5-19	Destination-Coded Vehicle	73	
Figure 5-20	Public Corridor Effective Design Width	76	
Figure 5-2 1	Security Inspection Station Layouts	77	
Figure 5-22	Typical Departure Lounge Layout	80	
Figure 5-23	Typical Combined Security/Departure Lounge Layout	81	
Figure 5-24	Departure Lounge Passenger Processing Area	81	
Figure' 5-25	Departure Lounge Typical Seating/Aisle Layout	82	
Figure 5-26	Mechanized Claim Devices	83	
Figure 5-27	Inbound Baggage Claim Frontage - Less than Five EQA Arrivals in Peak 20 Minutes . .	85.	
Figure 5-28	Inbound Baggage Claim Frontage - Five or More EQA Arrivals in Peak 20 Minutes....	86	
Figure 5-29	Baggage Claim Area	87	
Figure 5-30	Non-Public Baggage Claim Input Area	88	
Figure 5-3 1	Food and Beverage Services	92	
Figure 5-32	Concessions and Building Services	93	
Figure6-1	FIS Facility Functional Adjacency Diagram	97	
Figure 6-2	FIS Preclearance Facility Functional Adjacency Diagram	99	
Figure 9-1	Outline of the Ground Access System Planning Process	112	
Figure 9-2	Centralized Ground Access Concept	113	
Figure 9-3	Segmented Ground Access Concept	115	

Figure 9-4	Decentralized Ground Access Concept	116
Figure 9-5	Unitized Ground Access Concept	117
Figure 9-6	Terminal Curb Area	119
Figure 9-7	Vehicular Island Curb	120
Figure 9-8	Estimated Requirements for Public Parking at U.S. Airports	122

TABLES

Table 1-1	Hub Classifications	2
Table 2-1	Base Year Total Gate EQA Computation	12
Table 2-2	Sample - Future Design Year Total Gate EQA Computation	13
Table 4-1	General Lighting Requirements	51
Table 5-1	Recommended Selection Criteria Outbound Baggage Equipment	74
Table 5-2	Corridor Capacity in Persons Per Unit Width Per Minute	75
Table 5-3	Departure Lounge Area Space Requirements	78
Table 6-1	FIS Space and Facility Requirements at International Airports	104
Table 9-1	Typical Curb Frontage Dwell Times and Vehicle Slot Lengths	121

CHAPTER 1. INITIAL PLANNING CONSIDERATIONS

1. INTRODUCTION.

a. This advisory circular (AC) presents guidance material for the planning and design of airport terminal buildings and related access facilities.

b. The material and nomographs included herein provide general guidelines and approximations for determining space and terminal facility requirements for planning purposes. It is not intended that they be used to replace the detailed **engineering** analyses necessary for the specific design of individual airport terminal facilities.

c. Much of the material contained in this AC appears in various documents listed in Appendix 1. Architectural, engineering, and planning consultants are advised to review the referenced documents, as they contain supplemental information and provide more in-depth treatment of much of this material. The Transportation Research Board's (TRB) Special Report 215, **Measuring Airport Landside Capacity**, is particularly recommended.

d. AC 150/5360-9, **Planning and Design of Airport Terminal Building Facilities at Nonhub Locations**, contains guidance material for use in planning terminal facilities at low activity airports. It may be used in lieu of or in conjunction with this document, as appropriate.

2. AIRPORT MASTER PLANS.

a. Prior to initiating an airport terminal building design project, the master **planning report** for the airport under study should be reviewed. Most airports will have such a report on file.

b. Airport master plans (see AC 150/5070-6, **Airport Master Plans**) contain considerable information useful to the terminal planner/designer. Typically, these plans will contain the following data and analyses: an inventory of relevant data pertaining to the service area and existing airport **facilities**; **activity** forecasts; capacity analyses; estimates of facility requirements; environmental studies; various plans on airport layout, land use, terminal area, and intermodal surface access; etc. Planning horizons for master planning studies usually cover 5, 10, and 20 years into the future.

c. The terminal plan contained in an airport master plan is normally **limited** to layouts and drawings delineating general location, overall area, and basic configuration of the terminal area. For new airports or terminals, this plan may be limited to conceptual studies, layouts, and schematic drawings depicting the basic flow of passengers, cargo, and the various modes of airport surface access.

d. In most cases, the planner/architect should design the terminal facility to conform to the broad framework and guidelines established in the master plan. However, the master plan should be reviewed periodically, reevaluated, and, if necessary, appropriately revised to account for subsequent developments or definitive planning.

3. **FACTORS INFLUENCING TERMINAL CONFIGURATION AND SIZE.** In addition to historical traffic volumes, each airport has its own combination of individual characteristics to be considered in configuring and sizing terminal facilities. Similarly, each airline serving an airport has internal procedures, policies, and staffing criteria which influence facility planning. Some of **the** basic considerations which may significantly impact the planning and design of an airport terminal are discussed in following paragraphs.

a. **Service Area.** A form of reference often used to describe an airport's service area is the air traffic hub structure developed by the Federal Aviation **Administration (FAA)** to measure the concentration of

civil air traffic. Air traffic hubs are not airports; they are the cities and **Standard Metropolitan Statistical Areas (SMSAs)** requiring aviation service. Individual communities fall into four hub classifications (see Table I-1) as determined by each community's percentage of the total U.S. enplaned domestic revenue passengers carried.

Table I-1. Hub Classifications

Hub size	Percent of total enplaned passengers	1991 enplanements
Large (L)	1.0 percent or more	4,886,665
Medium (M)	0.25 to 0.9999 percent	1,221,663 to 4,886,665
Small (S)	0.05 to 0.249 percent	244,333 to 1,221,663
Nonhub (N)	Less than 0.05 percent	Less than 244,333

The location and number of air traffic hubs can be obtained from the latest issue of the Department of **Transportation Airport Activity Statistics**. Apart from obvious influences, such as physical size and topography, some of the more significant characteristics of the airport service area which may influence the airport terminal design include: population and per capita income and their growth potential; geographic location and distance from other airports with similar or larger service areas; concentration of commercial activity that involves a relatively high propensity for air **transportation**; and proximity of major **vacation/recreation areas**.

b. Passenger Characteristics. Two basic categories of passengers are those who travel for business purposes and those traveling as tourists or for personal reasons. Business passengers are usually more travel **experienced**; arrive just prior to flight time; and are more apt to use the full range of public terminal services and concessions. On the other **hand**, **vacation** travelers are more likely to arrive much earlier, relative to flight departure time, compared to business travelers; depart from the destination airport later; and, generate a larger number of visitors/greeters. Consequently, significant variations in the characteristics and ratio of these two passenger types can influence space requirements and staffing. A small airport serving a vacation/ resort area with a relatively short season will involve different requirements than an airport handling comparable peak-month volumes of predominantly business travelers. Similarly, an airport close to a military installation, or serving a college town, may generate a significant volume of standby traffic, thus warranting additional facilities and services.

c. Airline Station Characteristics. The route structures of the scheduled airlines serving an airport influence its character and, consequently, its facility requirements. Airports can generally be categorized into three types on the basis of the route structures of the using airlines. These categories and their related characteristics are discussed in succeeding paragraphs. The peak hour movements per gate specified (**gate utilization factor**) are typical for airports averaging six or more daily departures per gate.

(1) **Origination/Termination Airport.** This category of airport usually involves a high **percentage (over 70 percent of total enplanements)** of originating passengers and a preponderance of turnaround flights. Ground times range from 45 to 90 minutes, or more. The high flow of passengers between aircraft and ground transportation vehicles generates a relatively high requirement for ticket counter area, curbside length, and parking spaces per enplaned passenger. Passengers will usually require maximum baggage-handling services for checking and claiming baggage. Typical domestic peaks will average about 0.9 to 1.1 hourly aircraft movements per gate. Boarding load factors at this category of airport often range between 65 and 80 percent.

(2) **Through Airport.** This category has a relatively high percentage of originating passengers combined with a low percentage of originating flights, resulting in the shortest aircraft ground times. Boarding load factors may be lower than **origination/termination airports** (ranging from 40 to 60 percent), thereby reducing departure lounge space requirements. Typical domestic peaks will average 1.5 to 2.0 hourly aircraft movements per gate.

(3) **Transfer Airport.** This Category of airport has a significant proportion of passengers, at least 30 percent of total enplanements, transferring between on-line and off-line flights. Aircraft ground servicing times average 30 to 60 minutes, depending upon connecting patterns and airline operating policies. Typical domestic peaks average 1.2 to 1.4 hourly aircraft movements per gate. Compared to the same volume of enplanements at the other two categories of airports, the transfer airport has less ground transportation activity and a lower requirement for curb frontage; less need for airline counter positions serving normal ticketing and baggage check-in (although more positions may be required for flight information and ticket changes); less requirement for baggage claim area; more space for baggage transfer (on-line and/or interline baggage); increased requirements for concessions and public services; and increased need for centralized security locations.

d. **Aircraft Mix.** The forecast mix of aircraft expected to use an airport can significantly impact terminal design. For instance, airports serving a large variety of aircraft types and sizes require terminal facilities more flexible and complex than those serving predominantly one class of aircraft. The latter are more conducive to standardizing the area and facilities at each gate position. Terminals at airports serving wide-body aircraft require the ability to accommodate the large passenger surges which normally occur when these aircraft load or unload.

e. **Nonscheduled Service.** In addition to scheduled operations, most airports serve a variety of non-scheduled operations such as charter flights, group tour flights, and air-taxi operations. At some airports, a relatively high volume of airline charter or other nonscheduled operations may warrant consideration of separate, modest, terminal facilities for supplemental carriers. Occasionally, scheduled carriers may desire separate apron hardstands and buildings to serve charter operations which exceed the capabilities of facilities required for normal scheduled operations. Any such proposal should be evaluated thoroughly, since a separate facility can often create inefficiencies in such aspects as logistics, staffing, and ground equipment utilization.

f. **International Service.** Airports with international flights may have other characteristics which influence terminal planning and design. One characteristic is a tendency toward higher aircraft activity peaks because of the heavy dependence on schedules for city pairs related to time zone crossing. Another characteristic is the relatively long ground service times (2 to 3 hours for turnarounds, 1 hour for through flights) required for long range aircraft servicing. The additional space requirements for Federal Inspection Services (FIS) facilities will also affect terminal planning and design. (See Chapter 6.)

4. **TERMINAL SITING CONSIDERATIONS.** Since most terminal development involves the expansion or modernization of an existing facility or terminal complex, its location will more or less be fixed. However, in the case of a new airport or major airport redevelopment, a new terminal site may be necessary or desirable. There are a number of basic considerations which will affect the ultimate terminal site selection. Some of the more important of these considerations include:

a. **Runway Configuration.** The runway configuration at an airport has a significant impact on the location of the apron-terminal complex. The terminal site should be located to minimize aircraft taxiing distances and times and the number of active runway crossings required between parking aprons and runways. At airports with a single runway or very simple runway configuration (for instance, airports with a primary plus crosswind runway or single set of parallel runways), this may dictate locating the passenger terminal centrally with respect to the primary runway(s). At airports with more complex runway configurations, siting may require detailed analyses to determine runway use, predominant landing and takeoff directions, location and configuration of existing taxiways, and the most efficient taxiway routings. The runway configuration may also restrict ground access to certain areas of the airport and thus limit alternative terminal sites. Figure 1-1 depicts the relationship between runway configurations, terminal locations, and ground access facilities.

b. **Access to Transportation Network.** While the motor vehicle will remain the major mode of ground transportation to and from the airport, other public transit modes are expected to assume an increasing role. The passenger terminal should be located, when possible, to provide the most direct/shortest routing to the access transportation system serving the population center generating the major source of passengers and freight. Adequate area and distance should be provided between the transportation access network and the

primary terminal building (and within the terminal building) to accommodate the ultimate terminal development and **necessary future** ground access systems and improvements.

c. Expansion Potential. To assure the long-term success of an airport terminal facility, potential expansion beyond forecast requirements should always be taken into consideration. In the planning stage, the terminal should **be** conceived in its ultimate form with reasonable allowance for growth and changes in operation beyond forecasted needs. Use of this principal in selecting a terminal site or expansion scheme will promote the provision of adequate space around the terminal (both on the **airside** and landside) for orderly construction of succeeding stages.

d. FAA Geometric Design Standards. Terminal facilities require a location which will assure adequate distances from present and future aircraft operational areas in order to satisfy FAA airport geometric design standards. These standards include such minimum separation distances as those between a runway centerline and aircraft parking aprons, buildings, and airport property lines; and those between a **taxiway** centerline and **fixed/movable objects** and other taxiways. Refer to AC 150/5300-13, Airport Design, for information on FAA airport geometric design standards.

e. Existing and Planned Facilities. Existing and planned structures and utilities should be carefully inventoried and taken into account when planning new or expanded terminal facilities. In some cases, existing facilities or utilities, which are not related to and are restrictive to terminal development, can be demolished, abandoned, or relocated to a more suitable area. In other instances, existing conditions may limit the number of possible alternative terminal sites. In all cases, existing or planned locations of a FAA control tower, navigational aids, weather equipment, etc., should be analyzed to assure that terminal development will not interfere with line-of-sight or other operational restrictions associated with these facilities.

f. Terrain. Topographical conditions should be considered in the selection of a terminal building site. For instance, potential drainage problems can be reduced if the terrain lends itself to naturally carrying water away from the building. Developing the terminal site on relatively flat land can prove economically advantageous by reducing grading or quantities of fill. However, an existing terrain feature, such as a grade differential between the landside of the terminal and an aircraft parking apron, can be incorporated into a multi-level terminal concept.

g. Environmental Impacts. The location of a terminal facility or major expansion of an existing one may result in significant environmental impacts which must be analyzed and weighed, if capacity is increased by 25 percent or more, in considering alternative terminal sites. The FAA airport layout plan (ALP) approval process associated with terminal facility planning includes necessary environmental assessment.

h. General. Figure 1-2 illustrates the terminal facility's role as the transfer mode from airport **landside** to airport **airside**.

5. PROJECT COORDINATION. Planning and designing an airport terminal complex requires considerable coordination and input involving a number of airport users and other interested parties. Participants in such a process include: airport management; the consultants engaged to perform the planning and/or design; tenant airlines; the FAA; Federal Inspection Services (FIS) representatives (if international service is involved); local governmental planning agencies; building concessionaires; and, other airport tenants. The requirements of each of these parties may differ somewhat and in some cases conflict with each other or with the design concept. These differences require resolution and/or compromise as early in the planning/design stage as possible. For this reason, it is advisable to establish a terminal facility advisory committee composed of representatives of airport management, planning consultants, airlines, and other principal airport tenants. This committee can meet periodically to **review** the terminal design and provide input as a project progresses.

6. - 19. RESERVED.

Figure 1-1. Terminal Siting/Runway Configuration Relationships

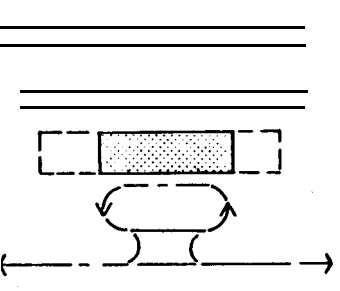
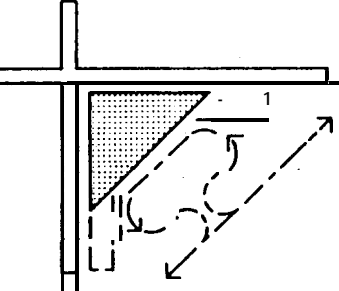
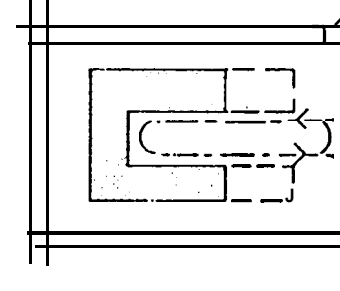
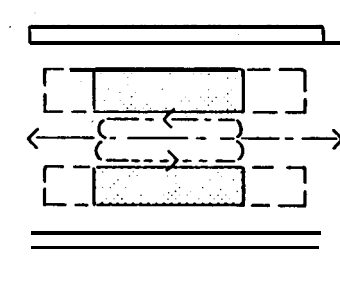
TERMINAL	GROUND-ACCESS CHARACTERISTICS	APRON-TERMINAL RELATIONSHIPS	LAYOUT
	ACCESS FROM SINGLE POINT USING ONE-WAY LOOP ROAD	SINGLE OR CLOSELY PLACED PARALLEL RUNWAYS: LIMITING APRON TERMINAL ON ONE SIDE	
	ACCESS FROM SINGLE POINT USING ONE-WAY LOOP ROAD	RUNWAYS WITH INTERSECTING AXES; LIMITING APRON TERMINAL ON TWO SIDES	
	ACCESS FROM SINGLE POINT USING ONE-WAY LOOP ROAD	WIDELY SPACED PARALLEL RUNWAYS WITH INTERSECTING CROSSWIND RUNWAY OR TAXIWAY ; LIMITING APRON TERMINAL ON THREE SIDES	
	POSSIBLE ACCESS FROM TWO POINTS USING TWO-WAY AXIAL ROAD WITH ONE-WAY LOOP ROADS SERVING EACH APRON-TERMINAL AREA	WIDELY SPACED PARALLEL RUNWAYS WITH NO INTERSECTING CROSSWIND RUNWAY ; LIMITING APRON TERMINAL ON TWO SIDES . EXCEPT AS LIMITED BY TAXIWAYS	

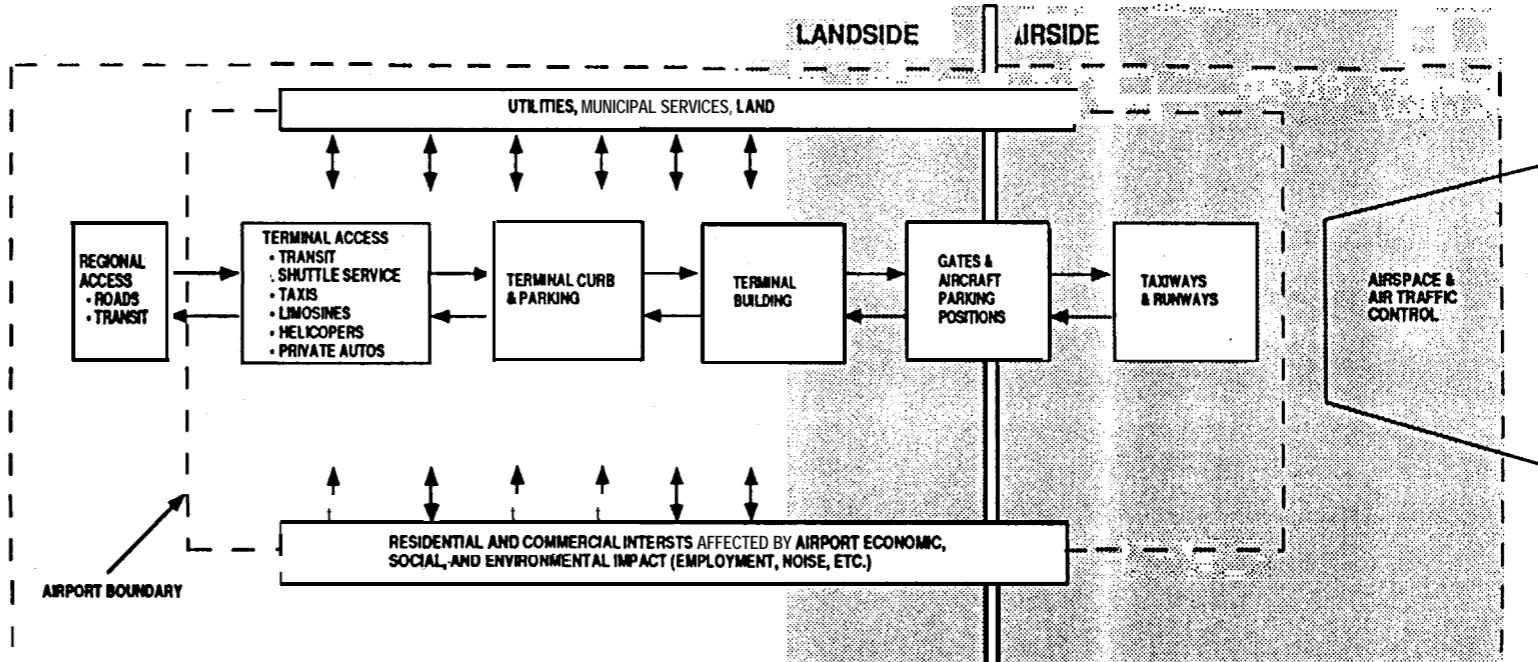

Figure 1-2. Functional View of an Airport

CHAPTER 2. DESIGN METHODOLOGIES

20. GENERAL. Effective planning and design of the terminal area involve the active participation of airport management, the airlines, concessionaires, and the consultants engaged by the parties. The process normally includes: compiling surveys, questionnaires, and forecasts, usually for short and intermediate periods; developing design day and peak hour activity tables; establishing passenger, aircraft, and vehicular traffic relationships; taking inventory and evaluating existing facilities; analyzing space requirements for alternative layouts; and estimating costs and developing financial plans. Sample forms for collecting design data are provided in Appendix 2. From this data collection, the designer can analyze alternative concepts and select the most economically feasible and practical terminal facilities.

21. FORECASTS. Airport terminal facilities are planned on the basis of activity forecasts. Depending on the various types of facilities being planned, the principal annual forecasts include passenger enplanements, passenger originations, and aircraft movements (by aircraft size). The most useful sources for this information include: the current airport master plan; the FAA published terminal area forecasts; forecasts developed by the Air Transport Association (**ATA**); and those forecasts developed by the individual airlines serving the airport. The airlines should be consulted for assumptions on trend changes in the ratio of originators to enplanements in scheduled service. Normally, nonscheduled operations are not considered the primary basis for terminal planning and should be evaluated separately.

22. TRANSLATING FORECASTS TO PEAK DEMANDS. Airport terminal facilities are planned, sized, and designed to accommodate peak passenger demands for a selected forecast period. Generally, the initial stage of construction is designed for a selected year (or years) within 5 to 10 years of the current period. Master plans look 20 years into the future. Planning for absolute peak demands, i.e., the greatest demands anticipated, will result in facilities impractically oversized and underutilized. Accordingly, the planner should be cautious in the use of data on absolute peak traffic volumes. Methodologies for converting annual forecast data to daily and hourly demand are discussed in paragraphs 23 and 24.

23. PEAK DAILY ACTIVITY. The Average Day/Peak Month (ADPM) represents the most common method of converting planning statistics to a daily and ultimately to an hourly demand baseline. A determination of the ADPM demand for the design year involves first identifying peak month enplanements as a percent of annual enplanements based on historical data. This percentage may be adjusted up or down as local circumstances and/or other factors dictate (seldom necessary). Applying this percentage to the annual enplanement forecast for the design year results in a peak month demand forecast for that year. Demand for the average day of the peak month of the design year is determined simply by dividing the peak month demand by the number of days in that month. The same ratio of annual originating passengers (or transfers) to annual enplanements can be assumed for ADPM passengers unless indicated otherwise by seasonal data or surveys. This ratio may vary during the peak hour at some airports.

24. PEAK HOURLY ACTIVITY. Many aspects of terminal facility planning require hourly volumes or statistics consistent with the average day baseline. An airport may have peak hour operations as high as 12 to 20 percent of daily total operations. As schedules increase, peaks tend to spread out over the day. A theoretical absolute low is 6.25 percent which assumes uniform distribution of domestic operations over 16 hours. Such a theoretical **low** normally never happens. In actual practice, some peaking will always occur, both in aircraft movements and, even more so, in passenger activity. The latter occurs even with a relatively uniform distribution of aircraft movements, since larger aircraft are normally scheduled in the prime hours of the day so as to best meet public demand. Several procedures for arriving at peak hour activities are discussed in the following paragraphs.

a. Hypothetical Design Day Activity Method. The recommended procedure for determining design peak hour activity statistics involves the use of aircraft movement data and load factors (historic and projections) obtained from the airline to develop a hypothetical design day activity table. This table is comprised of data columns depicting hypothetical arrival and departure clocktimes for the various airline flights, aircraft types, and passenger enplanements and deplanements for the average day/peak month of the selected design year. From these tables, passenger/visitor population plots can be developed for enplaning, deplaning, and total passengers. An example of an Enplaning Passenger/Visitor Population Plot is shown in Figure 2-1.

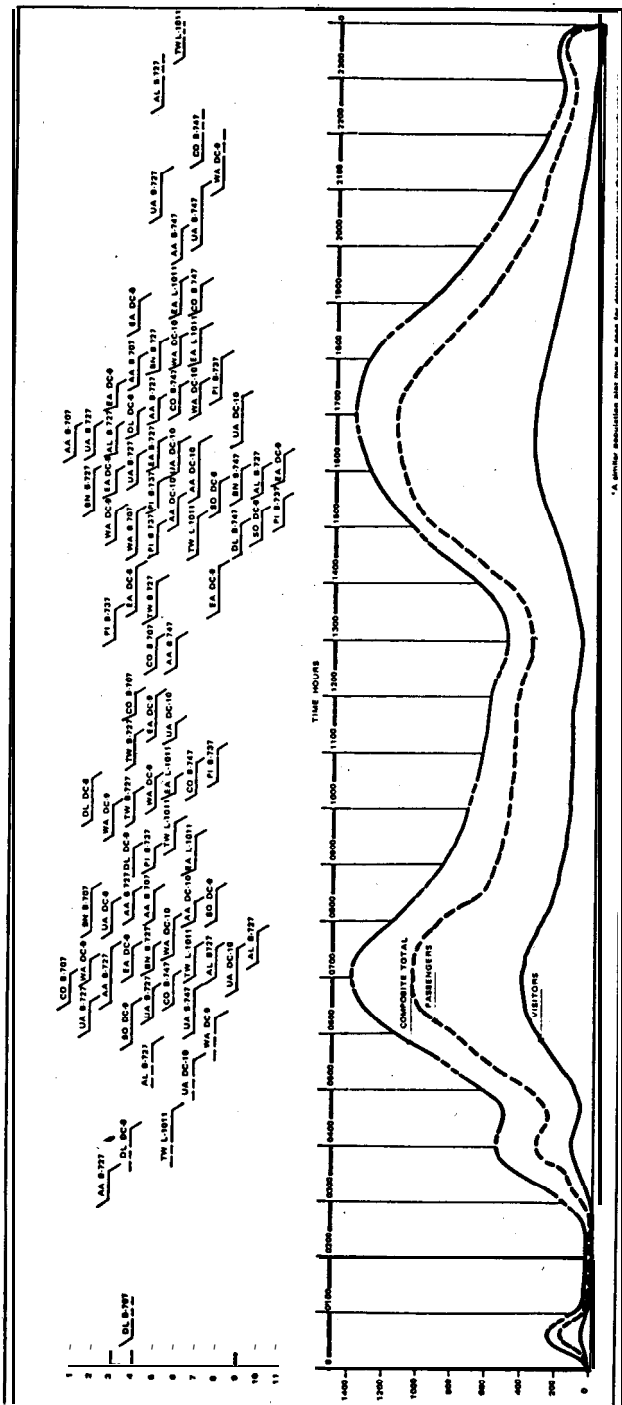

Figure 2-1. Hypothetical Aircraft Schedule and Arriving Passenger/Visitor Population Plot

b. Historical Peaking Factors.

(1) In lieu of developing a detailed design day activity analysis as discussed in the preceding paragraph, a simple method of estimating peak hour demand involves the use of the most recent data on peak hour demands at the airport under study. This information can be obtained from airline records of hourly enplanements and deplanements (total passengers) during the most recent peak month. If such information is not available, current data can be **collected for** a minimum 2-week period and then adjusted upward proportionately to correspond with the most recent peak month activity. From an analysis of the hourly counts obtained, a typical peak hour level of activity can be selected. This peak hour/peak month count can then be converted to a percentage (peaking factor) of the current ADPM enplanements. The peaking factor is then multiplied by the design year ADPM to arrive at a total passenger peak hour forecast for the design year.

(2) The peaking factor methodology requires judgment in application. Studies have shown that, with an increasing total passenger volume, the peak hour percentage decreases, since the peaks tend to spread out more over a day. Accordingly, a downward adjustment to the design peak hour count may be appropriate. This methodology is less accurate than the hypothetical design day activity (HDDA) method; The HDDA procedure is highly sensitive to passenger surges occurring in time increments of less than one hour (e.g., ticket counters, baggage systems, etc.). It also may be insensitive to the peaking conditions created by the future introduction of larger aircraft service which, in all likelihood, will be scheduled during peak hours.

c. Peaking Graphs. Peaking graphs have been developed for the purpose of making order-of-magnitude estimates of passenger and aircraft activity. *They are not satisfactory for design and/or detailed analyses of a particular airport.* Each has been developed largely by examining data from a number of airports and are representative of "averages." They *do not* represent an average condition for an individual airport and should not be used as such.

(1) Figure 2-2 provides a rough estimate of the percentage of peak day aircraft operations to be expected in the busiest hour of the day. The curve was developed from airline schedules. Airports with substantial international, tourist, and long-haul traffic often exhibit unusually high peak hour activity. Conversely, those with a large proportion of short-haul traffic and those with runway or gate capacity restrictions have less sharply defined peaks.

(2) The information shown in Figure 2-3 relates passenger peaking factors to annual **enplaned** passengers. Passenger peaking more or less parallels aircraft activity. However, passenger peaks may be more sharply defined than aircraft peaks because larger-than-average aircraft are introduced in prime times. The values shown were developed largely from reported passenger volumes, supplemented with values derived from aircraft operations at smaller airports.

(3) Figure 2-4 presents peak hour operations related to annual **enplaned** passengers. Shown are an average relationship based on 1975 schedules and one based on 10-year projected increases in average fleet seating and load factors. Since terminal development is generally sized for a forecasted passenger volume, it is important that changes in the average fleet size be considered.

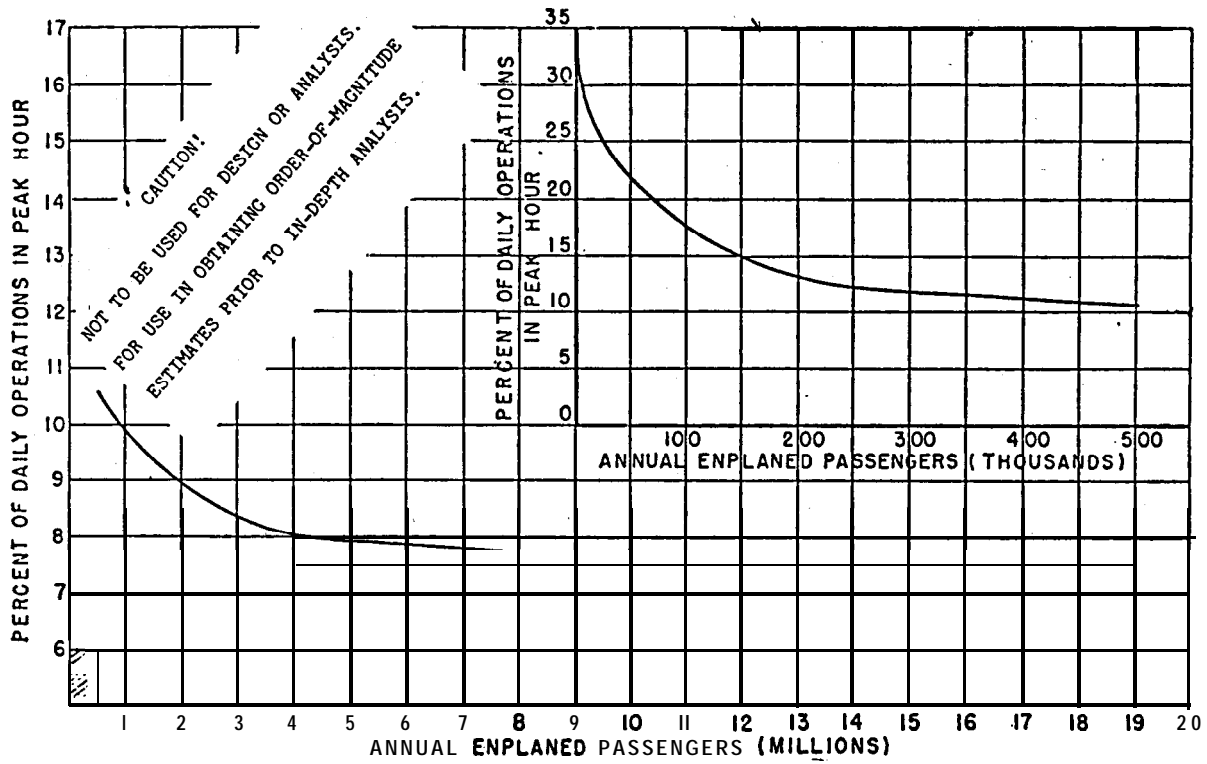

Figure 2-2. Percent of Daily Operations in Peak Hour vs. Annual Enplaned Passengers

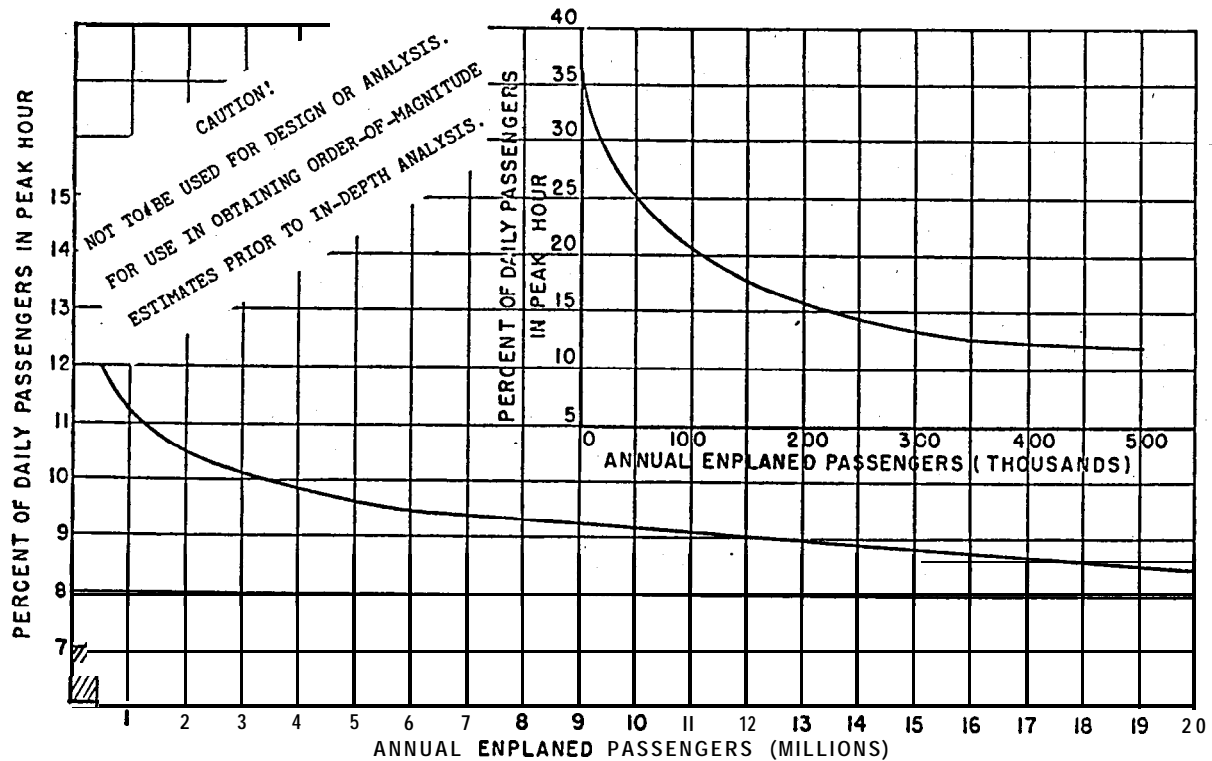

Figure 2-3. Percent of Daily Passengers in Peak Hour vs. Annual Enplaned Passengers

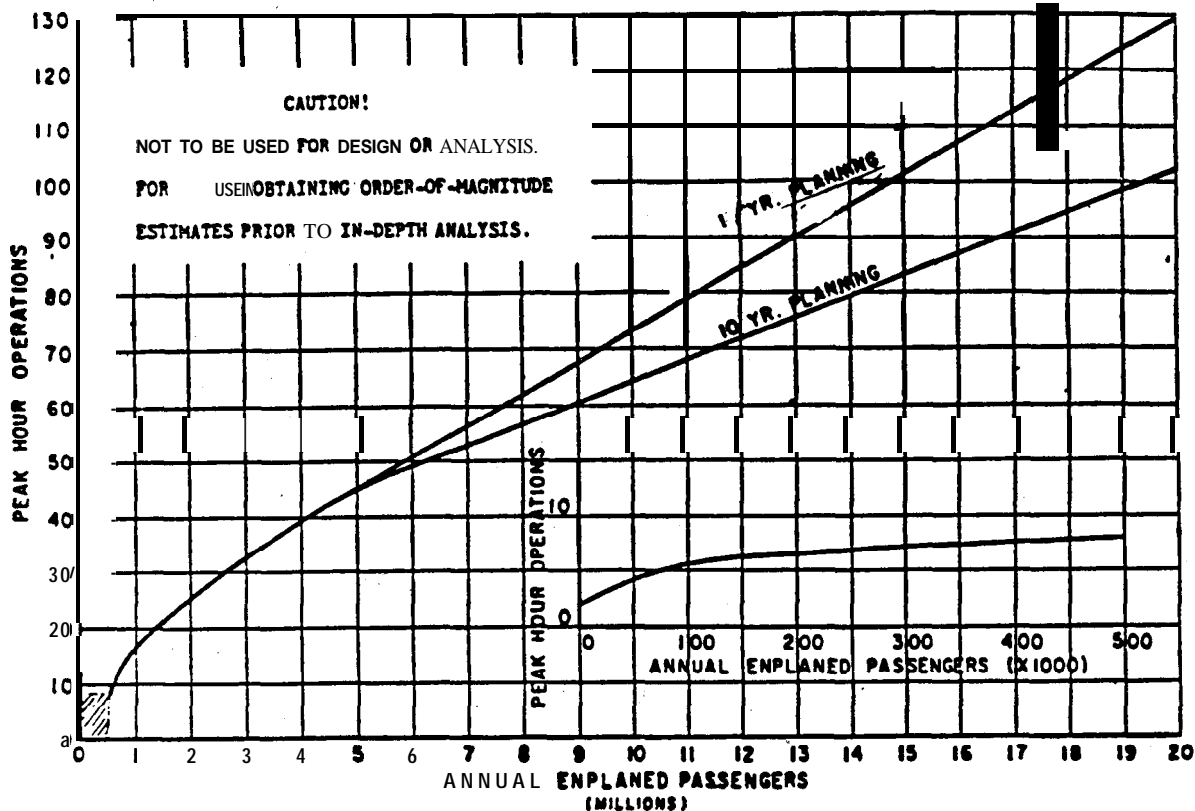

Figure 2-J. Estimated Peak Hour Operations vs. Annual Enplaned Passengers

d. **Rules-of-Thumb.** In the absence of historical data, the rules-of-thumb discussed in the following paragraphs may be used for roughly estimating activity levels. Their use should be similar to the “peaking” graphs, that is, they are *not intended* for a detailed design analysis of an individual report.

(1) Either peak hour enplaned or deplaned passengers may be assumed to represent approximately 60 to 70 percent of the total peak hour passengers.

(2) Peak month passengers may be approximated as 10 percent of the annual passengers.

(3) Average day-peak month aircraft operations may be estimated as 1.05 times the average daily activity for the year.

25. EQUIVALENT AIRCRAFT (EQA) FACTORS.

a. The sizing of most terminal elements is based on passenger volumes for a selected design hour or some part thereof--enplanements, deplanements, peak 20 minutes, etc. However, forecasts of these activities are not always readily available. When they are not, approximations can be developed by considering aircraft seating capacities, as estimated for the peak hour of the average day-peak month. Applying EQA factors, which represent the aircraft's passenger capacity (seats divided by 100) is useful in estimating the impact of future growth on various terminal components.

b. The EQA methodology is based on aircraft movements as the primary generators of passenger flows. The magnitude of each flow is related to aircraft seating capacities and load factors. However, average seats per aircraft movement increase in future years, often with larger aircraft being introduced first during peaks for prime time flights. Accordingly, it is reasonable to assume that boarding load factors and gate utilization will also increase in the future.

c. The EQA technique provides a common denominator for numbers of gates and aircraft seats useful for sizing terminal components and evaluating capacities in airport master planning. Specific sizing applications of EQA in this document include airline ticket office, ticket counter frontage areas, baggage areas, lobbies, departure lounges, etc., and are discussed in Chapter 5.

d. Tables and charts provided in this documentation for use in obtaining terminal facility sizing approximations require a knowledge of the following EQA factors: Base **Year Total Gate EQA**, Future Total Gate EQA; and, EQA Arrivals. The methods for calculating these factors are discussed in following paragraphs.

26. BASE YEAR TOTAL GATE EQA. To obtain this value, identify the appropriate category of aircraft seating capacity for each active gate position. Note that the number of base year active gate positions may be greater or less than the **number** of actual gates. Consistent double parking of aircraft at one gate should count as two active gate positions. Conversely, a new terminal facility may not have all its gates "active." Multiply the total number in each category by the appropriate EQA Conversion Factor, and sum the results. Table 2-1 illustrates this computation.

Table 2-1. Base Year Total Gate EQA Computation

Aircraft Seating Capacity	No. of Active Positions	EQA Conversion Factor ¹	GATE EQA	Aircraft Type
421 to 500	___	4.8	= ___	B747 (high dens./stretch)
341 to 420	___	3.9	= ___	B747
281 to 340	___	3.4	= ___	DC-10/L1011 (high dens./stretch)
221 to 280	___	2.7	= ___	B747-SP/DC-10/L1011
161 to 220	___	2.0	= ___	DC-8-61/A300/B767/B757
111 to 160	___	1.4	= ___	DC-8/B707/B727-200/DC-9-50
81 to 110	___	1.0	= ___	B737/DC-9-30/BAE-146-100&200
61 to 80	___	0.7	= ___	DC-9-10/BAC-111
1 to 60	___	0.5	= ___	CV-580/DHC-7/SD3-30&60/F-227/F-28
Base Year Total = GATE EQA				

¹ When actual seating is known, divide the number by 100 to determine the EQA Factor.

27. FUTURE TOTAL GATE EQA. To compute a future design year Total Gate EQA, it is first necessary to know the forecasted peak hour ADPM movements for each aircraft type (based on seating capacities). This information can either be obtained from ATA Airline Airport Demand Forecast Reports or from master planning studies, as appropriate. Additionally, the total number of forecast aircraft gates for the future design year must be known or calculated (see paragraph 43). To determine Future Total Gate EQA, first allocate future gates at one per peak hour movement for all seating capacity aircraft categories above 160. Then, proportionately allocate the remaining gates among the remaining categories. (Note that in the case where peak hour utilization is less than 1.0, the additional number of gates in excess of the peak hour movements are to be added to the aircraft groups with seating capacity > 160.) Then, multiply the number of gates by the EQA Conversion Factor for each aircraft seating group and add the products. Table 2-2 depicts a sample calculation.

Table 2-2. Sample — Future Design Year Total Gate EQA Computation

(Design Year — 1995; Forecast Gates — 21 ¹)

A/C Seating Capacity	1995 Per Hr ADPM Movements ²	No. Gates ³		EQA Conv. Factor ⁴	Gate EQA
421 to 500	—	—		—	—
341 to 420	—	—		—	—
281 to 340	1	—	x	3.4	3.4
221 to 280	4	—	x	2.7	10.8
161 to 220	3	—	x	2.0	6.0
111 to 160	9	—	x	1.4	9.8
81 to 110	6	—	x	1.0	4.0
31 to 80	3	2	x	0.7	1.4
1 to 60	—	—		—	—
Total	26	21			⁵ 35.4

¹ See paragraph 43.
² Source: **ATA** Airline Airport Demand Forecast.
³ Allocate one gate per movement for seating capacity categories > 160 and then allocate remaining gates proportionally to equal total of 21 gates.
⁴ Use actual conversion factors when available (seating capacity divided by 100).
⁵ Total Gate EQA for 1995.

28. EQA Arrivals. The term “EQA Arrivals” is synonymous with “EQA Inbound” and is used primarily for sizing baggage claim facilities. Passenger aircraft arrivals in periods of peak 20 minutes are the basis for these calculations. This can be approximated by assuming that 50 percent of the total gates are used in those periods for arriving aircraft. To determine EQA Inbound, allocate projected design year gates beginning with the largest aircraft until 50 percent of the gates are used. (This will ensure adequate facilities for the highest potential peak 20 minute passenger load.) The number of gates occupied by each aircraft type is then multiplied by the appropriate EQA Conversion Factor and the sum of these products is the EQA Inbound.

29. FORECAST REASONABILITY CHECKS. Activity forecasts and variables which influence sizing should be examined for reasonability. The following are key examples:

a. Passenger Traffic Growth (Scheduled Operations). Local airport growth should be compared against that forecast for the U.S. domestic market.

b. Ratio of Originating Passengers to Total Enplanements. Assumptions used in forecasting a change to the current ration should be explained. This information is particularly important for planning auto parking facilities, curb lengths, airline counters, and baggage claim areas.

c. Boarding Load Factor. The number of boarding passengers versus available seats should be compared. Any ADPM load factors outside the range of 55 percent to 60 percent should be reviewed with the airlines. Peak hour average load factors may be 15 to 25 percentage points higher.

d. Aircraft Growth Trends. Projected growth in aircraft seating capacities should be compared with boarding load factors.

e. Gate Utilization. Existing and forecast annual enplanements per gate and daily arrivals per gate should be identified and checked for reasonableness of any projected change.

13

f. Aircraft Movements. Peak hourly operations as a percent of daily operations for ADPM should be verified. Forecast changes up or down from the existing ratio, should be explained, recognizing that the ratio of peak hourly to daily operations tends to decline as traffic increases. The relationship between peak hourly passengers and daily passengers may not follow an identical trend, since larger aircraft are usually introduced into prime time or peak periods.

g. Nonscheduled Operation& The forecast ratio of passengers carried in nonscheduled operations versus those for scheduled service should be reviewed. Separate statistics should be kept when existing volumes or forecast growth represent a significant percentage of total operations. Assumptions used in forecasting a significant impact of nonscheduled traffic growth in terminal operations or in proposing separate facilities to accommodate this growth should be explained.

h. Number of Scheduled Carriers. Assumptions for any anticipated increase or decrease in the number of carriers require an explanation. The facilities needed by four airlines to serve 100,000 domestic enplanements will usually be more than those for two or three carriers handling the same volume.

30. RESERVED.



CHAPTER 3. FUNCTIONAL RELATIONSHIPS AND TERMINAL CONCEPTS

31. **MAJOR TERMINAL COMPONENTS.** The terminal complex functions as an area of interchange between ground and air transportation modes. To accomplish this interchange, the following major components are required:

a. **Apron.** The apron comprises the area and facilities used for aircraft gate parking and aircraft support and servicing operations. It includes the following sub-components:

(1) Aircraft Gate Parking Positions--used for parking aircraft to **enplane** and deplane passengers. The passenger boarding device is part of the gate position.

(2) Aircraft Service Areas--on or adjacent to an aircraft parking position. They are used by airline personnel/equipment for servicing aircraft and the staging of baggage, freight, and mail for loading and **un-**loading of aircraft.

(3) Taxilanes--reserved to provide taxiing aircraft with access to and from parking positions.

(4) Service/Fire Lanes--identified rights-of-way on the apron designated for aircraft ground service vehicles and tire equipment.

b. **Connector.** The connector consists of the structure(s) and/or facilities normally located between the aircraft gate position and the main terminal building. At low activity airports, i.e., less than approximately 200,000 annual **enplaned passengers**, this component is often combined with the terminal building component. It normally contains the following elements:

(1) Concourse--a passageway for circulation between aircraft gate parking positions and the main terminal building.

(2) Departure Lounge--an area for assembling and holding passengers prior to a flight departure. In some instances, it may be a mobile lounge also used to transport passengers to a parked aircraft.

(3) Security Inspection Station--a control point for passenger and baggage inspection and controlling public access to parked aircraft.

(4) Airline Operational Areas--areas set aside for airline personnel, equipment, and servicing activities related to aircraft arrivals and departures.

(5) Passenger Amenities--areas normally provided in both the connector as well as the terminal components, particularly at the busier airports with relatively long connectors. These amenities include rest rooms, snack bars, beverage lounges, and other concessions and passenger services.

(6) Building Maintenance and Utilities--areas often included in the connector component to provide terminal building maintenance and utilities.

c. **Main Terminal Building.** The following elements comprise this component:

(1) Lobbies--public areas for passenger circulation, services, and passenger/visitor waiting.

(2) Airline Ticket **Counters/Office** Areas--areas required for ticket transactions, baggage check-in, flight information, and administrative backup.

(3) Public Circulation Areas--areas for general circulation which include stairways, escalators, elevators, and corridors.

(4) Terminal Services--facilities, both public and nonpublic, which provide services incidental to aircraft flight operations. These facilities include rest rooms, restaurants and concessions, food preparation and storage areas, truck service docks, and miscellaneous storage.

(5) Outbound Baggage Facility--a nonpublic area for sorting and processing baggage for departing flights.

(6) Intraline and Interline Baggage Facility--a nonpublic area for processing baggage transferred from one flight to another.

(7) Inbound Baggage Facility-La nonpublic area for receiving baggage from an arriving flight and public areas for baggage pickup by arriving passengers.

(8) Federal Inspection Services--a control point for processing passengers arriving on international flights.

(9) Airport Administration and Services--areas set aside for airport management, operations, and maintenance functions.

d. Airport Access System. This component is composed of the functional elements which enable ground ingress and egress to and from the airport terminal facility. They include the following:

(1) Curb--platforms and curb areas (including median strips) which provide passengers and visitors with vehicle loading and unloading areas adjacent to the terminal.

(2) Pedestrian Walkways--designated lanes and walkways for crossing airport roads, including tunnels and bridges which provide access between auto parking areas and the terminal.

(3) Auto Parking--areas providing short-term and long-term parking for passengers, visitors, employees, and car rental.

(4) Access Roads--vehicular roadways providing access to the terminal curb, public and **employee** parking, and to the community roadway/highway system.

(5) Service Roads--public and nonpublic roadways and fire lanes providing access to various **sub**-elements of the terminal and other airport facilities, such as air freight, fuel tank stands, postal facility, and the like.

32. FUNCTIONAL RELATIONSHIPS OF TERMINAL COMPONENTS.

a. Activities within the terminal building can be categorized primarily into three functional areas: processing and servicing passengers; handling and processing of belly cargo (including passenger baggage); and, aircraft servicing. Consequently, a good terminal design necessitates a layout in which the various components are located in a sequence or pattern which coincides with the natural movement and services each requires, and those activities and operations which are functionally dependent on each other. Such a **design** will minimize passenger walking distances, airline servicing and processing times, and congestion caused by the intermingling of nonrelated activities.

b. Figure 3-1 presents the usual functional components of a typical terminal from curb to aircraft parking apron in terms of sequence of flow. For simplicity, only two relationships are used in the figure; that in which functional adjacency is essential for good design; and that in which it is merely recommended. The relationships, although graphically depicted in a single plane, apply equally to multilevel terminals. It should not be implied that every terminal should provide for all of the functions shown or that each function must have an individually defined area. For example, at low activity airports, one general space may suffice for multiple functions, such as a combined lobby, ticket counter area, and waiting lounge. Figure 3-2 shows these same functional adjacency relationships in a matrix format.

33. OBJECTIVES IN SELECTING TERMINAL CONCEPTS.

a. The objective of the terminal area plan should be to achieve an acceptable balance between passenger convenience, operating efficiency, facility investment, and aesthetics. The physical and psychological comfort characteristics of the terminal area should afford the passenger an orderly and convenient progress **from an** automobile or public transportation through the terminal to the aircraft and vice versa. Some of the objectives to be considered in the development of a terminal area plan are minimum walking distance, convenient auto parking, and convenient movement of passengers through the terminal complex. Conveyances such as moving walks and automated baggage handling systems should be considered for high volume airports.

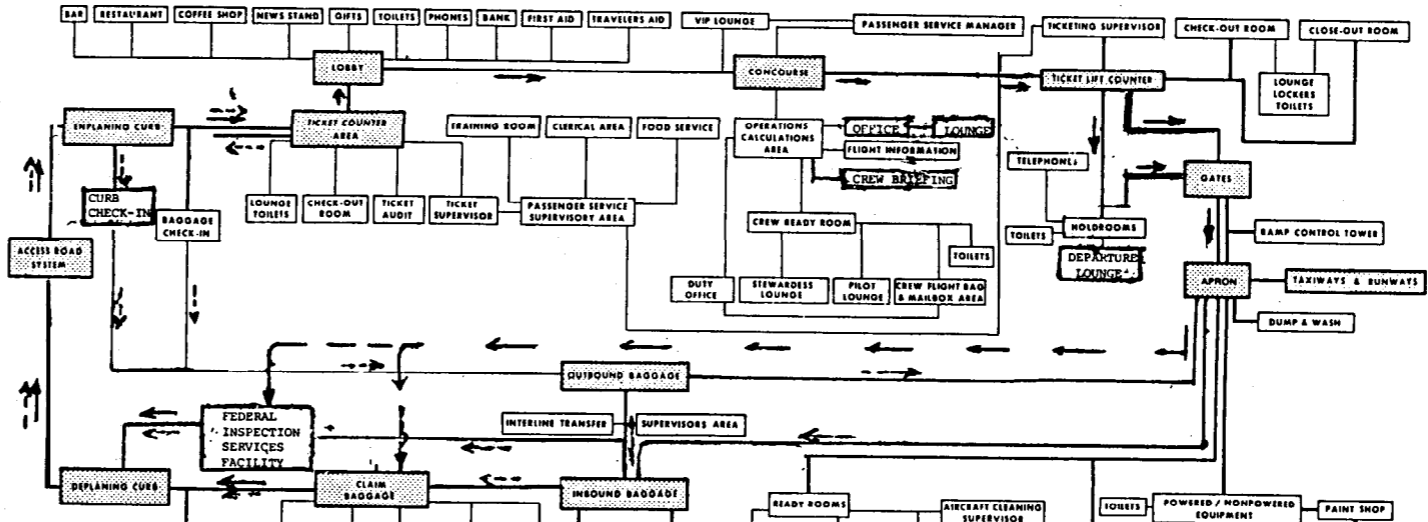

Figure 3-1. Functional Adjacency Diagram

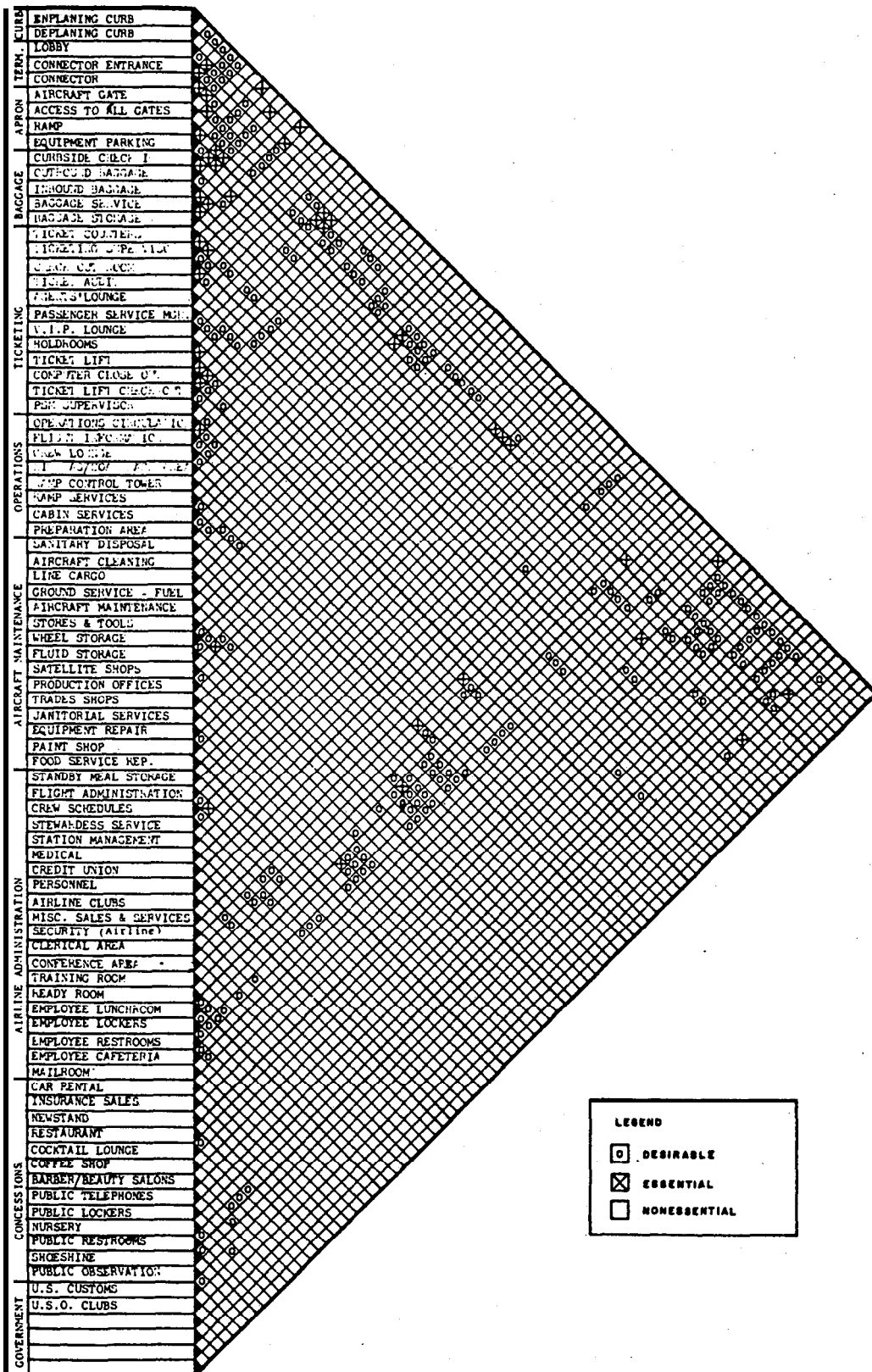

Figure 3-2. Functional Adjacency Matrix

18

b. The terminal complex's functional arrangement should be flexible enough for expeditiously handling passengers and ground-servicing aircraft to achieve minimum gate occupancy time and maximum airline operating economy. The ultimate plan should strive to meet these objectives within acceptable funding levels while considering not only capital investment but also maintenance and operating costs. Regardless of the scheme selected, the importance of complete planning flexibility to permit expansion both horizontally and vertically at minimum cost and with as little interference as possible to existing facilities cannot be over-emphasized.

34. **CENTRALIZED AND UNIT TERMINALS.** There are two basic concepts for the arrangement of the terminal area. In a centralized terminal, all passengers and baggage are processed in one building. Most airports utilize this arrangement. At some high activity airports, however, each airline (or several airlines combined) may be located in a separate terminal building. This is referred to as a unit terminal concept. These two design concepts are often combined in varying degrees. Examples of airports having a unit terminal concept include John F. Kennedy International, Kansas City International, and Dallas-Ft.Worth Regional airports. A single centralized terminal building has many advantages and for most situations is preferable. It represents a reasonably compact operation without the significant problem of transferring passengers and baggage between buildings. Building maintenance and operating costs for the centralized terminal will generally be significantly lower than the total costs for operating all unit terminals. A unit terminal concept can be justified only at the very high activity airports, particularly where the percentage of airline transfer passengers is relatively low. An efficient transportation system for passenger and baggage transfer between buildings is a must and should be incorporated in the design at an early stage.

35. **ALTERNATIVE TERMINAL BUILDING CONCEPTS.** A terminal building design can be categorized as one of five basic concepts or a variation or combination of them. The connector is the single element that distinguishes between the various concepts, since it is different in each case. Terminal building concepts are categorized in the following manner:

a. **Simple Terminal Concept.** The simple terminal consists of a single common waiting and ticketing area with exits leading to the aircraft parking apron. It is suitable at airports with low airline activity with an apron providing close-in parking for three to six commercial transport aircraft. A simple terminal normally consists of a single level structure with two to four gates with access to aircraft by walking across the aircraft parking apron. The layout of the simple terminal should take into account the possibility of pier or linear extensions for terminal expansion.

b. **Linear Concept.** In the linear concept (Figure 3-3), aircraft are parked along the face of the terminal building. Concourses connect the various terminal functions with the aircraft gate positions. This concept offers ease of access and relatively short walking distances if passengers are delivered to a point near gate departure by vehicular circulation systems. Expansion may be accomplished by linear extension of an existing structure or by developing two or more linear-terminal units with connectors.

c. **Pier Concept.** The pier concept (Figure 3-4) provides interface with aircraft along piers extending from the main terminal area. In the pier concept, aircraft are usually arranged around the axis of the pier in a parallel or perpendicular parked relationship. Each pier has a row of aircraft gate positions on both sides, with the passenger right-of-way or concourse running along the axis of the pier and serving as the circulation space for enplaning and deplaning passengers. Access to the terminal area is at the base of the connector (pier). If two or more piers are used, spacing for aircraft maneuvering between the piers by means of an apron taxilane(as discussed in paragraph 46, is required.

d. **Satellite Concept.** The satellite concept (Figure 3-5) consists of a building, surrounded by aircraft, which is separated from the terminal and usually reached by a surface, underground, or above-grade connector. Aircraft are normally parked in radial or parallel positions around the satellite. The satellite can have common or separate departure lounges. Since enplaning and deplaning of aircraft are accomplished from a common area, mechanical systems may be employed to transport passengers and baggage between the terminal and satellite.

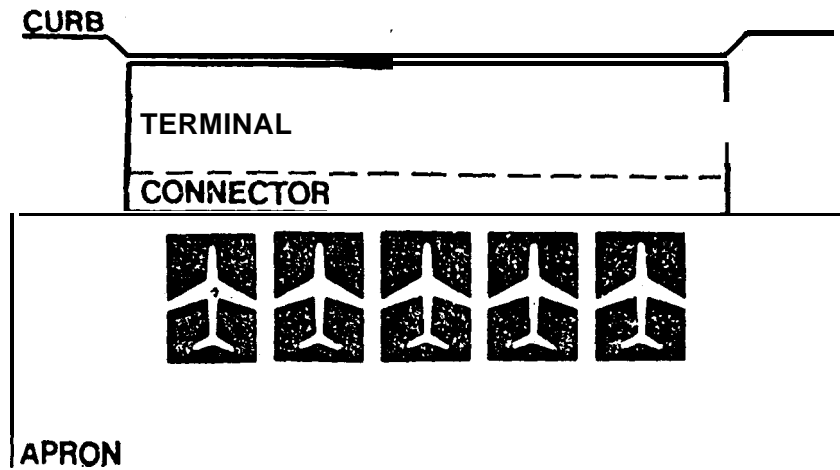

THE LINEAR CONNECTOR MAY CONSIST OF ONE OR BOTH OF THE FOLLOWING:

- A CONCOURSE, ENCLOSED AT THE FIRST OR SECOND LEVEL, CONNECTING TO THE TERMINAL ALONG A LINE OF PARKED AIRCRAFT WITH ACCESS TO THESE AIRCRAFT AT THE AIRCRAFT GATE POSITIONS
- A CONCOURSE CONNECTING TICKET POSITIONS, BAGGAGE CLAIM AREAS, ETC.

NOTE: DEPARTURE LOUNGES, CONCOURSE RELATED TO FUNCTIONAL AREAS.

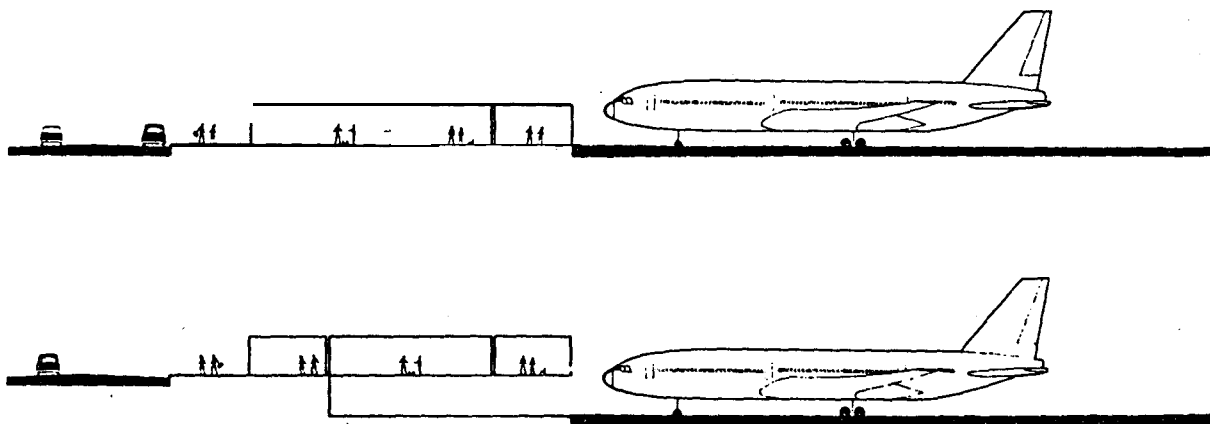

Figure 3-3. The Linear Concept

THE PIER CONNECTOR MAY CONSIST OF:

- A COVERED CONCOURSE AT GRADE LEVEL.
- A COVERED CONCOURSE ENCLOSED AT SECOND LEVEL.

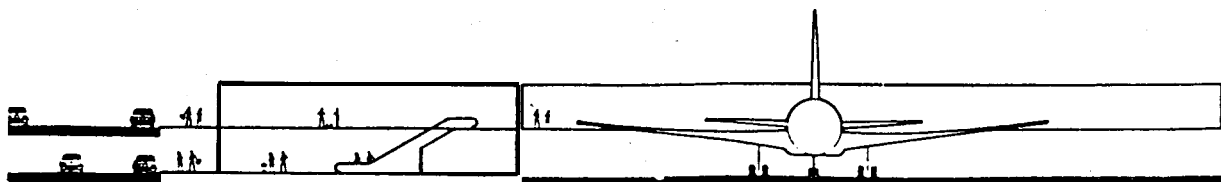
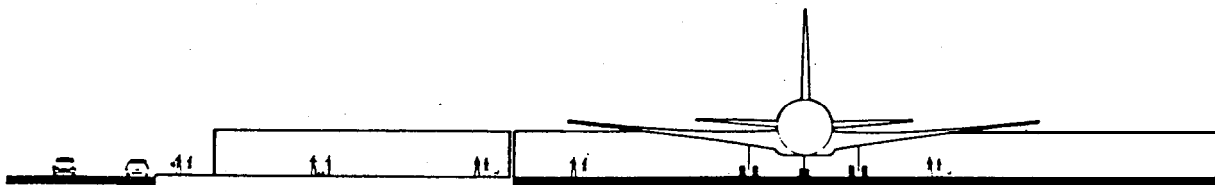
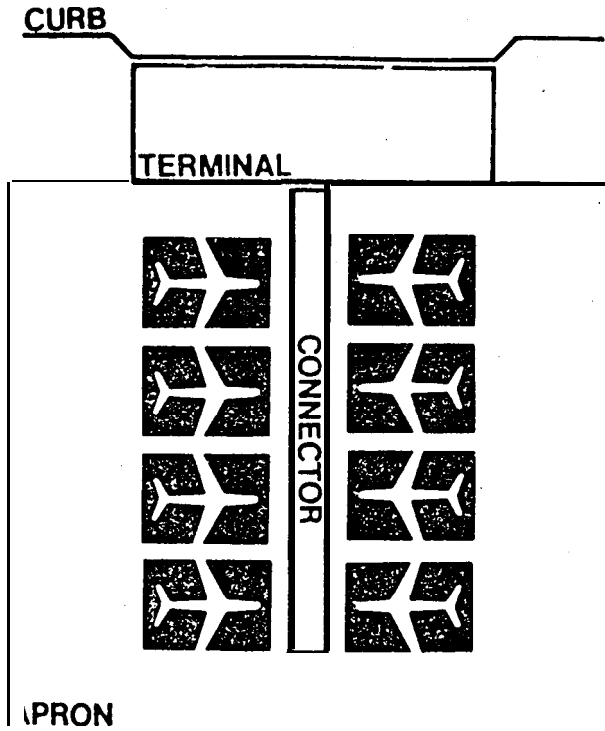

Figure 3-4. The Pier Concept



THE SATELLITE CONNECTOR MAY CONSIST OF:

- A CONCOURSE BELOW, AT OR ABOVE GRADE CONNECTING THE SATELLITE BUILDING WITH THE TERMINAL.

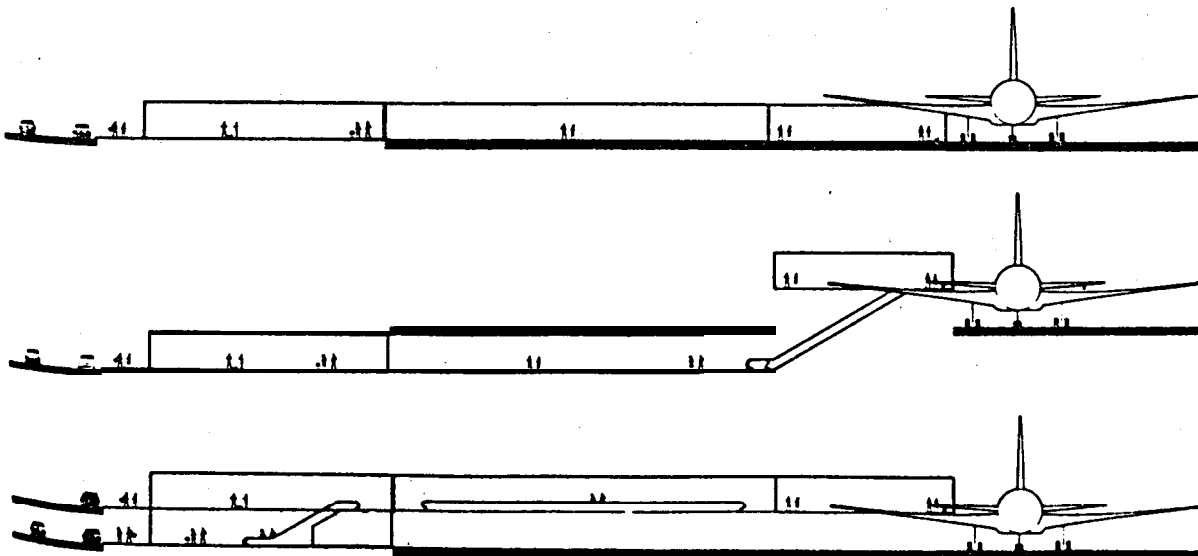
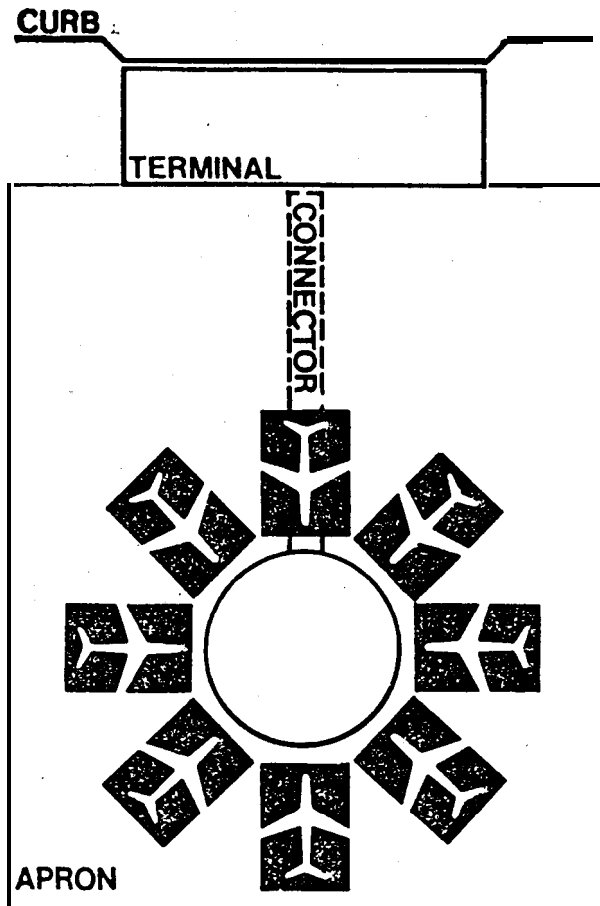

Figure 3-5. The Satellite Concept



e. Transporter Concept. Aircraft and aircraft-servicing functions in the transporter concept (Figure 3-6) are remotely located from the terminal. The connection to the terminal is provided by vehicular transport. The advantages of the transporter concept include flexibility in providing additional aircraft parking positions to accommodate increases in schedules; ease and speed in maneuvering aircraft in and out of parking positions under their own power; separation of aircraft servicing activities from the terminal; and reduced walking distances for passengers. Transporters may also be used in establishing remote gates for charter flights. The disadvantages mainly relate to the initial, operational, and maintenance costs associated with the transporter vehicles, although the increased transfer times required in changing airplanes can also be detrimental to airport efficiency.

36. SINGLE-LEVEL/MULTILEVEL TERMINALS. The decision on whether the terminal building design should incorporate single or multilevels for processing passengers and baggage is influenced primarily by the volume of traffic. **Variations** of these designs are shown in the bottom elevations depicted on Figures 3-3 through 3-6 and are discussed as follows:

a. Single-level Terminal. The single level terminal is the preferred design at the majority of small and **nonhub** airports. The processing of passengers and baggage takes place at the same level as the apron, and the entire layout is quite simple and economical.

b. Multilevel Terminal. At a traffic level of over 500,000 annual **enplaned** passengers, structures of more than one story should be investigated. In this concept, arriving and departing passengers are vertically separated. Enplaning passengers are usually processed on the upper level and deplaning passengers on the lower level. The fingers or piers leading to the aircraft are usually two stories, whereas, the terminal **enplaning** and deplaning curbs may be on single or multilevels, as discussed in the following paragraph. The principal advantage of a multilevel terminal is the reduction of congestion by segregating opposing flows of passengers and baggage. The disadvantages are the higher initial investment and the continuing higher operation and maintenance costs. In evaluating the design of a multilevel terminal, the physical limitations of the site, terrain, and airline station characteristics are important considerations.

c. Multilevel Curbs. While single level curbs may be utilized with all concepts and traffic volumes, multilevel curbs are appropriate only at multilevel terminals. Construction of multilevel curbs should be considered when passenger volumes exceed one million enplanements or when physical limitations within the terminal area or building frontage make curb separation desirable. Multilevel curbs, with their corresponding structural roads and ramps, are costly to construct and should be considered only after investigation of single-level alternatives.

d. Second Level Aircraft Boarding. Boarding and deplaning aircraft from the second story is the usual procedure at multilevel terminals for reasons of simplicity and efficiency, unless limited by terrain features. Conversely, for the same reasons, apron-level boarding is the norm for single-level terminals. However, severe or extreme weather conditions, or other considerations, may justify second-level boarding at a single-level terminal. In such cases, two story connectors, raised pier structures, or inclined loading bridges can be utilized. Airports with over 500,000 annual enplanements are candidates for second-level boarding installations. In some situations, a combination of apron and second-level boarding gates may be a desirable alternative.

37. TERMINAL CONCEPT COMBINATIONS AND VARIATIONS.

a. Combinations and variations of terminal concepts often result from the changing conditions experienced at an airport during its lifespan. An airport may have many types of passenger activity, varying from originating and terminating passengers using the full range of terminal services to passengers using limited services on commuter flights. The predominant type of activity usually affects the initial terminal concept selected. In time, **the amount of traffic** may increase, necessitating **modification** or expansion of the facilities. Growth of aircraft size, a new combination of aircraft types serving the airport, or a change in the type of service may affect the suitability of the initial concept. Similarly, physical limitations of the site may cause a pure conceptual form to be modified by additions or combinations of other concepts.

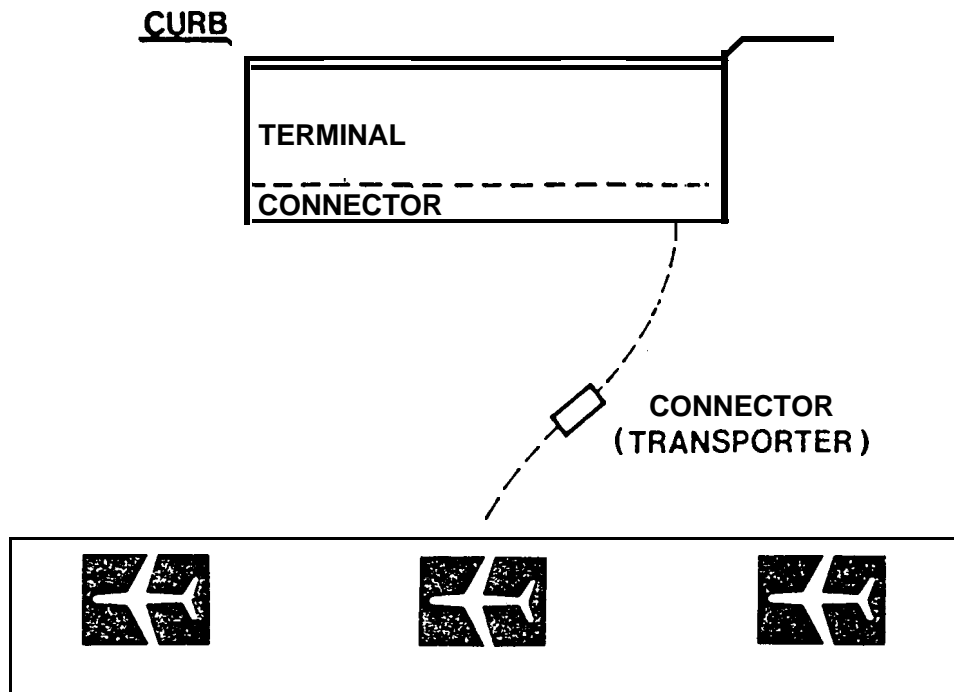

THE TRANSPORTER CONNECTOR MAY CONSIST OF:

- A NON-ELEVATING VEHICLE THAT PERMITS ENPLANING AND DEPLANING AT APRON LEVEL AT THE AIRCRAFT AND AT THE TERMINAL.
- AN ELEVATING VEHICLE THAT PERMITS DIRECT ENPLANING AND DEPLANING TO THE AIRCRAFT AND TERMINAL BY MOVING THE PASSENGER CAB VERTICALLY TO MATCH ENTRANCE LEVELS AT THE AIRCRAFT AND TERMINAL
- (DOTTED) A SECONDARY CONCOURSE CONNECTING TRANSPORTER POSITIONS.

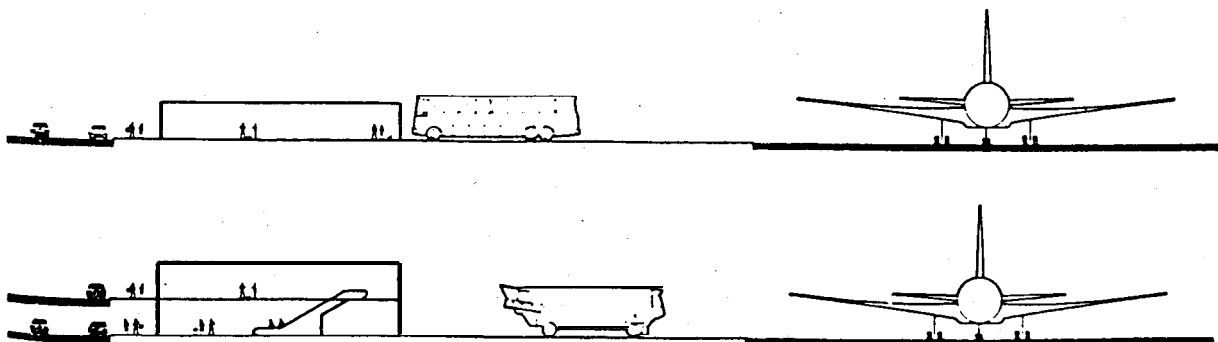

Figure 3-6. The Transporter Concept

b. Combined concepts acquire some of the advantages and disadvantages of each basic concept used. A combination of concept types can be advantageous where more costly **modifications** would be necessary to maintain the original concept. For example, while an airline may be suitably accommodated within an existing transporter concept terminal, a commuter operation with rapid turnovers is best served by a linear concept extension. In this case, concept combination is desirable. Thus, the appearance of concept variations and combinations in a total apron-terminal plan may reflect an evolving situation in which altering needs, growth, or physical limitations have determined the final terminal configuration. Figure 3-7 depicts concept combinations and variations typically utilized in airport terminal designs.

38. CONCEPT EVALUATION. Particularly at high activity locations, a thorough analysis of the type of terminal concept to be utilized at an airport should be conducted before a final decision is made. Initial evaluation efforts should narrow the choices down to two or more alternative schemes before development of preliminary layouts and drawings. The final choice should be made only after **indepth** analyses are completed. Quantifiable aspects of each concept (walking distances, areas required, etc.) should be compared; efficiency studies of passenger and aircraft flows, ground vehicular movements, and operational/functional sequences conducted; and cost estimates made. At very high activity airports with complex inter-relationships, the application of simulation techniques may be warranted. Some of the principal factors which should be considered in the overall evaluation of alternatives are discussed in following paragraphs. A more thorough discussion on concept evaluation may be found in Report No. FAA-RD-73-82, The Apron-Terminal Complex - Analysis of Concepts for Evaluation of Terminal Buildings.

a. Airport Design Activity Levels. Figure 3-8 provides a matrix for identifying applicable terminal concepts related to design activity levels. The rationale behind the formulation of this matrix is as follows:

(1) For airports with projected design activity levels up to 200,000 annual **enplaned** passengers, simple or linear concepts with varying degrees of complexity at the higher **enplanement** levels appear to be the most appropriate. Low activity airports warrant a simple, compact structure incorporating all activities, including airfreight. As traffic increases, consideration should be given to providing covered walkways from the terminal element.

(2) For a design activity level between 200,000 and one million annual **enplaned** passengers, linear, pier, and satellite concepts are used. The linear concept, however, begins to exhibit an increasing degree of decentralization. The result is greater connecting distances for transfer passengers, while passengers who departed on one airline and returned on another are placed at greater distances from their parked automobiles. In addition, the linear concept, after reaching this activity level, requires a sophisticated signing and graphics system for identifying airlines, gate positions, and other activity centers.

(3) When the activity level exceeds one million annual **enplaned** passengers, pier, satellite, and transporter concepts are applicable. The first two concepts offer an additional alternative of utilizing multiple terminal units or a larger centralized terminal to accommodate the entire traffic load. At transfer airports, a multiple unit terminal or transporter concept may be inappropriate. This is due to inefficiencies resulting from transferring passengers and baggage between aircraft (e.g., transporter) or between airlines (e.g., multiple unit terminal).

b. Passenger Walking Distances. In evaluating alternate terminal concepts and building designs, major consideration should be directed toward keeping passenger walking distances to a minimum. This is particularly important at locations where there is considerable transfer between aircraft. Under these circumstances, walking distances become more time critical. Relationships between passenger walking distances and terminal concept selections are discussed in following paragraphs.

(1) A passenger activity level up to one million annual enplanements represents approximately a six to eight gate simple or linear terminal, normally, serving an aircraft mix up to B-727 size, and requires an average overall gate width of 110 to 130 feet (33 to 40 m). Aircraft park in front of the terminal, usually in a taxi-in/power-out operating mode. The terminal itself provides the common areas for the main functions, such as ticket counters, waiting space with concessions, and baggage-claim areas. The total overall length is approximately 700 to 1,000 feet (210 to 300 m). This means that the walking distance from the general areas in the terminal to the farthest gate is not more than 350 to 500 feet (105 to 150 m).

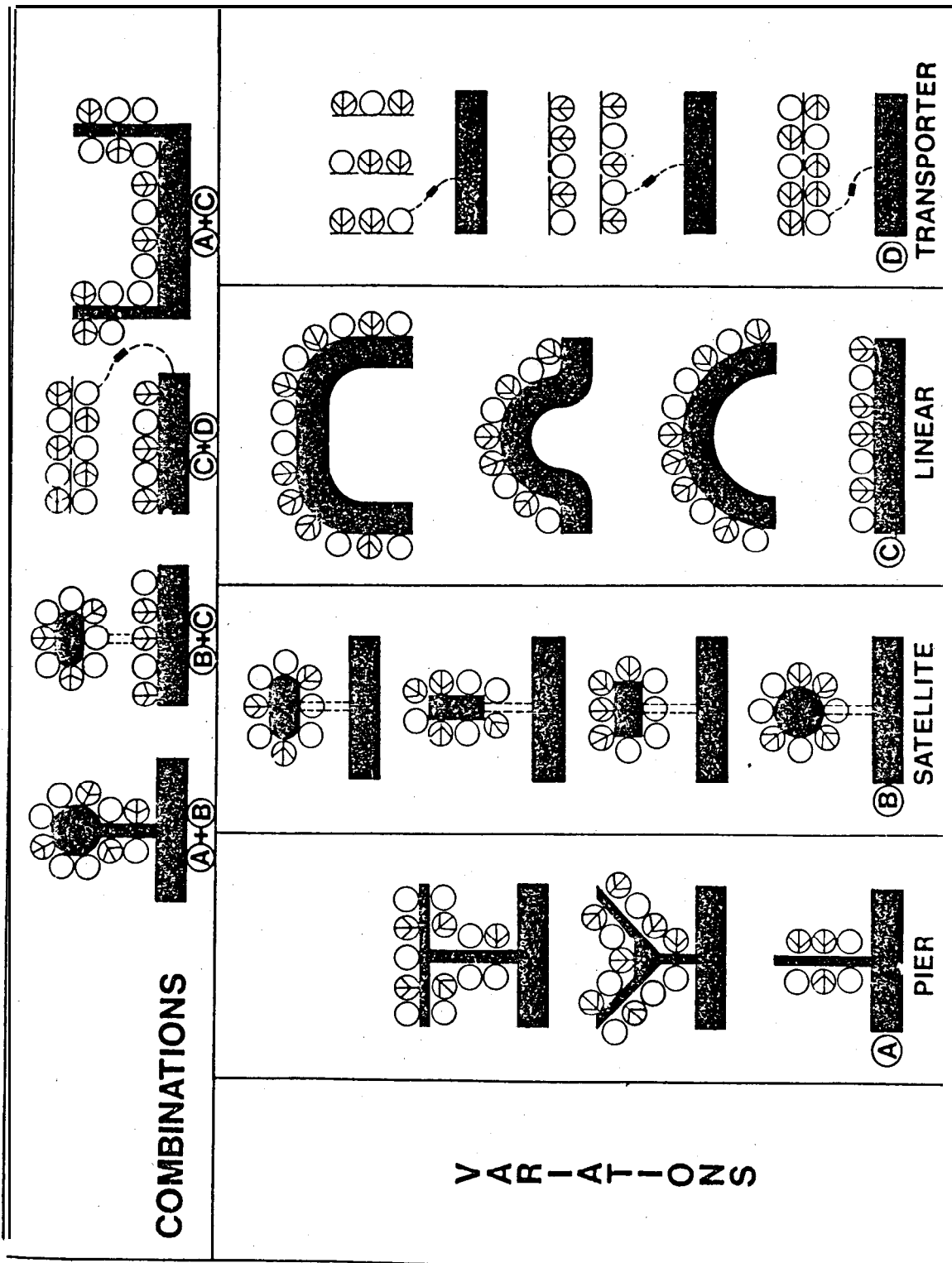

Figure 3-7. Concept Combinations and Variations



Airport Size by Annual Enplaned Passengers	CONCEPTS APPLICABLE				PHYSICAL ASPECTS OF CONCEPTS			MULTI LEVEL TERMINAL	SINGLE LEVEL CONNECTOR	MULTI LEVEL CONNECTOR	APRON LEVEL BOARDING	AIRCRAFT LEVEL BOARDING
	LINEAR	PIER	SATELLITE	TRANSPORTER	SINGLE LEVEL CURB	MULTI LEVEL CURB	SINGLE LEVEL TERMINAL					
FEEDER UNDER 25,000	X				X		X				X	
SECONDARY 25,000 TO 75,000	X				X		X				X	
75,000 TO 200,000	X				X		X		X		X	
200,000 TO 500,000	X	X			X		X		X		X	
PRIMARY OVER 75% PAX 0/D 500,000 TO 1,000,000	X	X	X		X		X		X	X	X	X
OVER 25% PAX TRANSFER 500,000 TO 1,000,000	X	X	X		X		X		X	X	X	X
OVER 75% PAX 0/D 1,000,000 TO 3,000,000		X	X	X	X	X		X	X	X	X	X
OVER 25% PAX TRANSFER 1,000,000 TO 3,000,000		X	X		X	X		X	X	X	X	X
OVER 75% PAX 0/D OVER 3,000,000		X	X	X	X	X		X	X	X	X	X
OVER 25% PAX TRANSFER OVER 3,000,000		X	X		X	X		X	X	X		X

Figure 3-8. Matrix of Concepts Related to Airport Size

(2) With an annual enplanement level between one million and three million, a mix of larger aircraft, including wide-body aircraft, will operate from the apron-terminal complex. Average gate widths will range from 150 to 180 feet (45 to 55 m). As a result, a unit of six to eight gates will reach an overall apron length of 1,000 to 1,500 feet (300 to 450 m). The overall walking distances will become even greater if aircraft are parked in a continuous single line, nose to tail. The common area will become individualized and walking distances and the distance between the terminal units will increase. Other concepts, such as the pier, satellite, and transporter, will become more appropriate for reducing walking distances.

(3) When the annual enplanement level reaches three million, with 25 percent or more transfer passengers, the transporter concept becomes less applicable since this concept increases the passenger transfer time between flights.

(4) When concept selection is limited, excessive walking distances can be made more tolerable by the installation of moving walkways, escalators, guideways, and other mechanized people moving systems.

c. Airline Station Characteristics. The characteristics of the route structure of the airlines serving the airport can be important factors influencing the selection of a terminal concept (e.g., transfer versus originating, domestic versus international, scheduled versus nonscheduled, etc.). Other factors include the size and type of aircraft used, aircraft ground and turnaround times, airline equipment and policies, and the like.

d. Physical Characteristics. The terminal concept selection is influenced by the physical characteristics of the terminal site such as the available area for expansion, existing facilities, terrain, airport layout, and access road systems.

e. Climatic Conditions. Extreme weather conditions of heat and cold, precipitation, wind, etc., can influence the selection of a terminal concept to provide optimum sheltering of passengers, baggage, and aircraft servicing areas.

f. Growth Potential. The potential for the growth of the airport requires considerable attention by the planner in choosing a terminal plan. Growth potential includes physical growth and airline growth. Airline growth takes into account future aircraft sizes, potential for increased flights, service equipment, and the introduction of new airlines.

39. - 40. RESERVED.

CHAPTER 4. TERMINAL APRON AREAS

41. **GENERAL.** Four primary considerations govern **efficient apron area** design: the movement and physical characteristics of the aircraft to be served; the maneuvering, staging, and location of ground service equipment and underground utilities; the dimensional relationships of **parked** aircraft to the terminal building; and, the safety, security, and operational **practices** related to apron control. **The primary** objective of **these** considerations is the ready accommodation of either a changing or static mix of aircraft. This **involves** maximizing the total **area in terms** of aircraft parking (interchangeability of types) with comparable relationships between these aircraft and the building. The optimum apron design for a specific airport will **depend upon** available space, aircraft mix, and terminal configuration.

42. **TERMINAL APRON GATE TYPES.** The terminal **gate types** used in this chapter relate to the wing spans and **fuselage** lengths of the aircraft which they **accommodate**. For dimensions of specific aircraft, refer to AC 150/5300-13, Airport Design. The aircraft **included** in **these gate types** make up the bulk of the U.S. commercial aviation fleet. These aircraft **serve** all types and lengths of **domestic** and international route structures. The four gate types are:

a. **Gate Type A.** The aircraft using this gate type are those found in Airplane Design Group III, wing span between 79 feet (24 m) and 118 feet (36 m). (Refer to AC 150/5300-13, for information on Airplane Design Groups.) The route structures of **these** aircraft vary from short **range/low** density to medium **range/ high** density.

b. **Gate Type B.** Airplane Design Group IV aircraft, wing span between 118 feet (36 m) and 171 feet (52 m), with a **fuselage** length less *than* 160 feet (49 m), use this gate type. These aircraft **serve** longer range routes than those served by aircraft using Gate Type A, but have similar **passenger** demands.

c. **Gate Type C.** This gate type **serves** Airplane Design Group IV aircraft with a **fuselage length greater than** 160 feet (49 m). The typical **route** structure is similar to that for those aircraft using Gate Type B, although with a **higher** passenger volume.

d. **Gate Type D.** Aircraft in Airplane Design Group V, wing span between 171 feet (52 m) and 213 feet (65 m), use this gate type. These aircraft operate on a long-range route **structure** and carry a high volume of **passengers**.

43. **ESTIMATING AIRCRAFT GATE POSITIONS.** The **required** number of aircraft gate positions will influence the **selection** of both the terminal **concept** and the building **design**. Similarly, the size and type of aircraft serviced at the airport and the airline parking arrangement and **procedures** will affect the apron area requirements and, ultimately, the size and layout of the terminal building. **Several** methodologies for estimating the number of required aircraft gate positions are discussed in succeeding paragraphs. These methodologies are applicable to domestic scheduled operations. **Gates** for international and commuter aircraft should be estimated separately. It is recommended that all of the first **three** methods be **utilized** for comparative **purposes** and appropriate judgment exercised on **estimating** the final number.

a. **Peak Hour Utilization.** The current (base year) peak hour gate utilization factor is obtained by dividing the **number** of peak hour movements by the number of **active gates**. (NOTE: See paragraph 26 concerning the counting of base year **active gates**.) Through discussions with the local airlines, a determination should be made on whether this base year utilization factor is applicable to the **design year** or **whether** an upward or downward adjustment is **warranted**. For rough **estimates**, the gate utilization factors **specified** in paragraph 3c can be used for the three basic airline stations. **These** factors are typical for airports with domestic operations averaging **six** or more daily departures **per gate**. **Future** total gates are **estimated** by dividing the **forecasted** design year peak hourly aircraft movements by the **selected** gate utilization factor.

b. **Daily Utilization.** Future total gate requirements can be **estimated** by dividing the forecast **design year** ADPM aircraft **departures** (one-half the aircraft movements) by a **projected** daily utilization factor. The latter is determined by dividing current ADPM aircraft departures by total active **gates** and applying a reasonable additional factor to account for greater **future gate** utilization. Industry increases normally **considered** appropriate **range** from 1.5 to 3.0 departures per gate for the 10 and 20 year **master planning forecasts**, respectively. These **increases** are

to be applied when the base year daily utilization is very low (four or less departures per gate). Generally, a daily utilization factor of 9 to 10 represents a ceiling for airport **master planning** purposes.

c. Annual Utilization. Future **gates** can be estimated from base year annual utilization and forecasted annual passenger enplanements by use of the nomographs in Figures 4-1 through 4-4. These figures provide intermediate (10 year) and long-range (20 year) forecasts of industry enplanements per active gate for high (Figures 4-2, 4-4) and low (Figures 4-1, 4-3) utilization airports. Low utilization averages **less** than six **daily departures** per gate and high utilization seven or more daily departures per gate for the average day of the peak month. After selecting the applicable **nomograph**, **determine** the current (base year) **annual** enplanements per active gate and enter this figure on the left side of the graph. On the right side, enter the ratio of forecast annual enplanements for the design year to the current year enplanements. A straight line **connecting** the two points will intersect the middle scale to estimate the design year **annual** enplanements per active gate. This number divided into the forecast design year annual enplanements will provide an estimate for total gate requirements.

d. Historical Data. Figure 4-5 provides a method for approximating gate requirements for initial planning and estimating purposes only. It is based on historic relationships between **annual enplaned** passengers and required gate positions.

44. **GATE PARKING PROCEDURES.** The parking procedures used by the airlines at an airport have considerable **effect** on the sizing and spacing requirements for gate positions.

a. Taxi-in, Push-out/Power-out Parking. This is **the** most common procedure used at high activity locations. It involves the taxiing of arriving aircraft directly into gate positions under their own power. Parking is generally nose-in and perpendicular to the building or pier finger. Departing aircraft either self power-out or are towed/pushed out by tractor/tug to a clear apron area **where** they can safely **proceed** under their own power. The procedure where an aircraft must be pushed or towed out is generally the most costly, from an operational standpoint. However, there are **offsetting** considerations which make its use both practical and advantageous at many locations. For one, it utilizes minimum gate area and therefore permits more gates for the same building or pier finger length. It also results in shorter loading **bridges** (**hence**, shorter passenger walking distances) and more efficient use of apron **space** and service equipment.

b. Taxi-in, Taxi-out Parking. This procedure is typically used at lower activity airports. Although it is less costly operationally, it requires more apron area and permits less gates **per pier finger/building** length. Aircraft taxi into and away from **gate** positions under their own power. Parking is either parallel to the building/pier finger or at **30, 45, or 60 degree** angles. The choice is influenced by airline **preference** and physical or other constraints. Angle parking requires less ramp frontage than parallel parking.

45. **AIRCRAFT GATE CLEARANCES.** **The** sizing and clearances required for the design of aircraft gate positions can vary considerably. Airline policies and procedures, type of towing and service equipment used, type of aircraft, and terminal configuration all play a role. However, for planning purposes, the following guidelines are provided:

a. Nose to Building Clearances. In the push-out/power-out configuration, the distance between the nose of an aircraft and the building may vary anywhere between 15 to 30 feet (4.5 to 9 m), or more. This dimension is dependent on **the** method of push-out employed and whether the building is single or multi-level. A minimal 15 to 20 feet (4.5 to 6 m) clearance is practical either when a tug **beneath** the aircraft pulls the aircraft from the gate or when tug maneuvering space is available in front of the aircraft beneath the second level of a building. Larger nose-to-building **dimensions** are frequently required when a tug must operate in front of the aircraft (pushing out). The actual dimension involved in each case **depends** on the aircraft nose gear's position relative to its nose, the tug length, and associated maneuvering or parking requirements. For **planning** purposes, 30 feet (9 m) should be used for gate type A; 20 feet (6 m) for gate types B and C; and 15 feet (4.5 m) for gate type D.

b. Nose to Tail Clearances. For taxi-in/out, in addition to **separation** for maneuvering, separation is required to accommodate the adverse effects of jet blast. Clearances on **the** order of up to 490 feet (149 m) for gate type D; 370 feet (113 m) for gate type C; and, 120 feet (37 m) for gate types A and B may **need** to be established to account for a 50 mph (80 km/h) jet blast. Use of **jet** blast **fences** and low break-away thrust operating procedures can considerably **reduce** these separations.

c. Wingtip to Wingtip Clearance. Clearances of 15 feet (4.5 m) for Gate Types B through D should be provided. At gates served by trans provided.

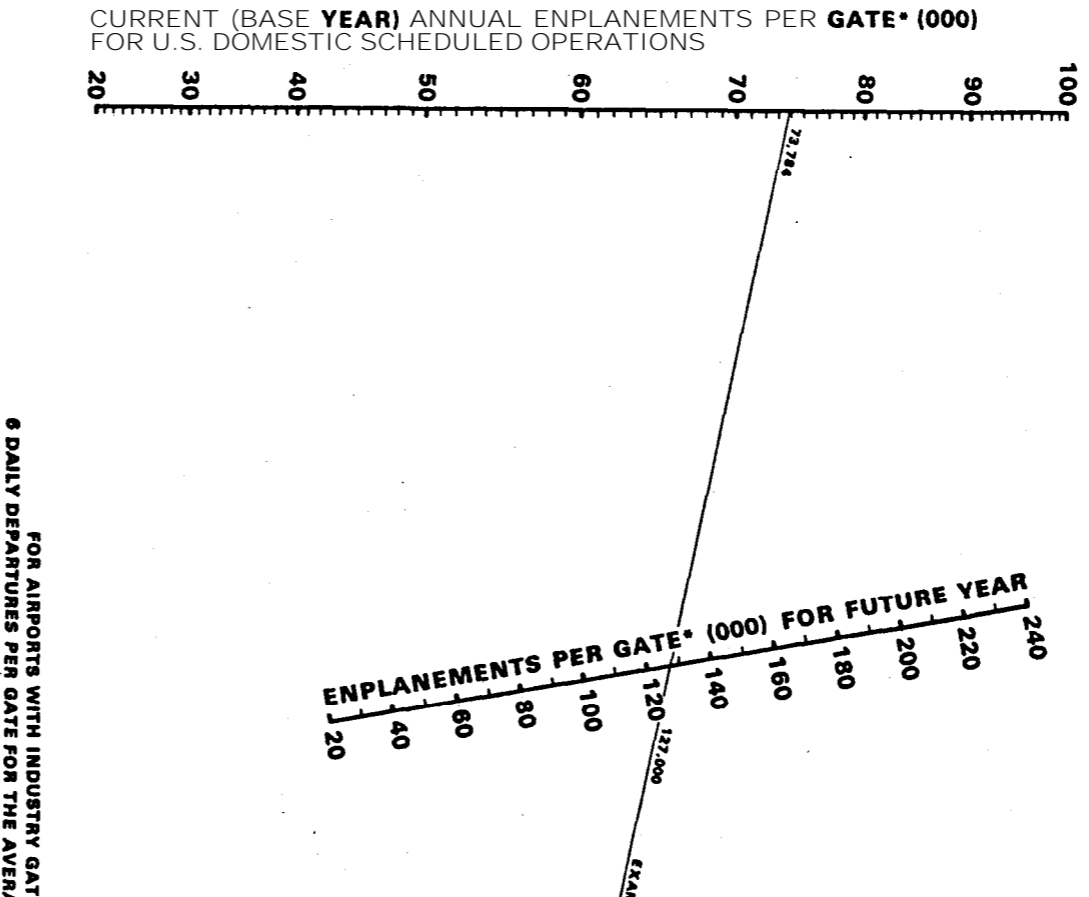
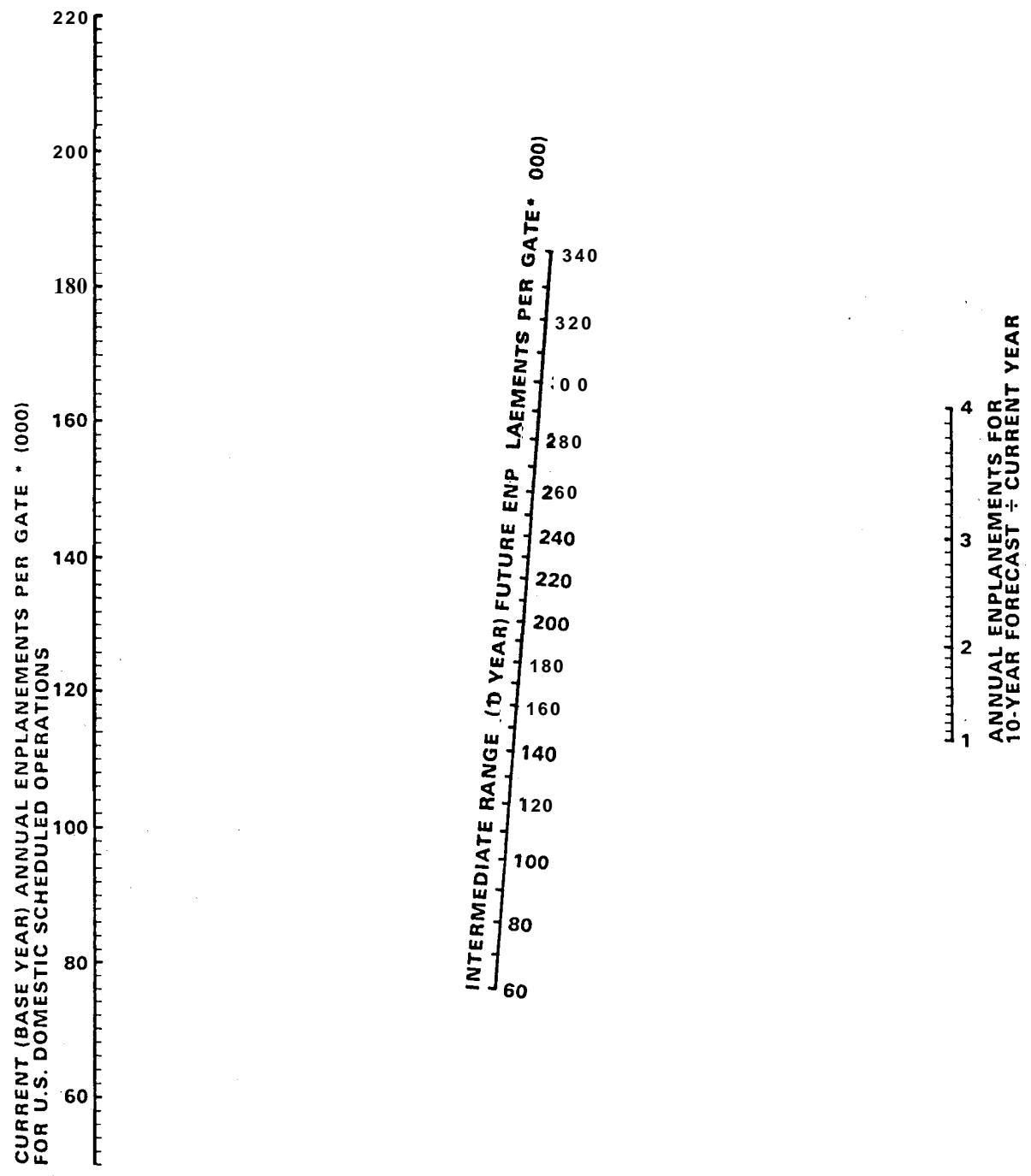

Figure 4-1. Enplanements Per Gate (10-Year Forecast - Low



FOR AIRPORTS WITH INDUSTRY GATE USE AVERAGING 6 OR MORE DAILY DEPARTURES PER GATE FOR THE AVERAGE DAY OF THE PEAK MONTH.
*ACTIVE POSITION

Figure 4-2. Enplanements Per Gate (10-Year Forecast - High Utilization)



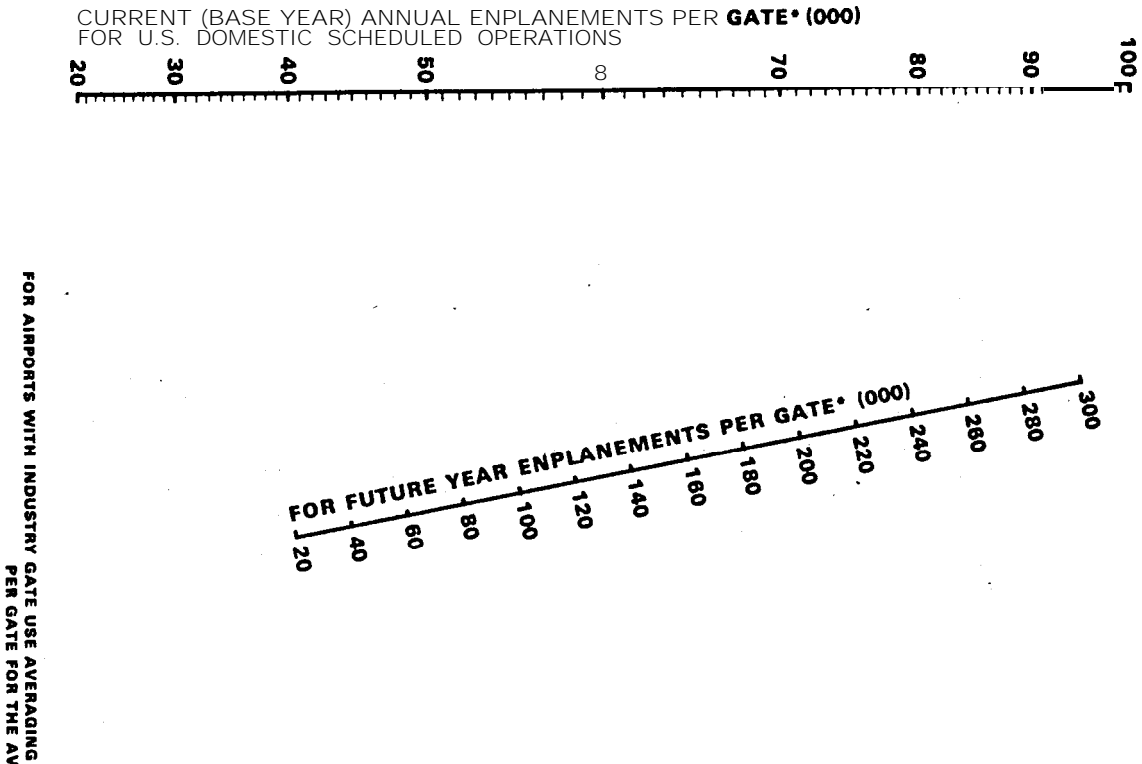
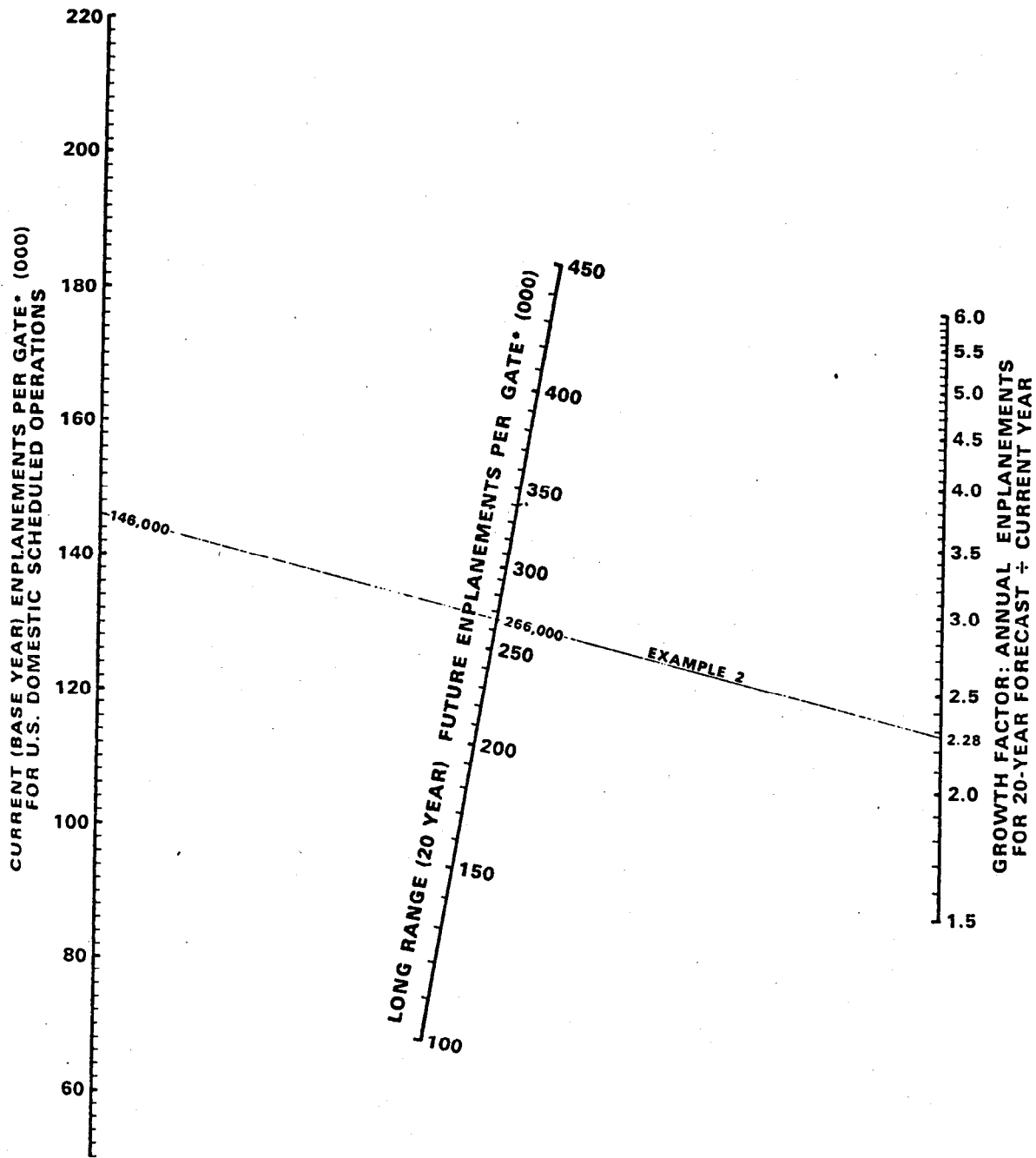

Figure 4-3. Enplanements Per Gate (20-Year Forecast -



FOR AIRPORTS WITH INDUSTRY GATE USE AVERAGING 6 OR MORE DAILY DEPARTURES PER GATE FOR THE AVERAGE DAY OF PEAK MONTH
(ACTIVE POSITION)

Figure 4-4. Enplanements Per Gate (20-Year Forecast - High Utilization)

Figure 4-5. Estimating Gate Positions vs. Annual Enplaned Pass

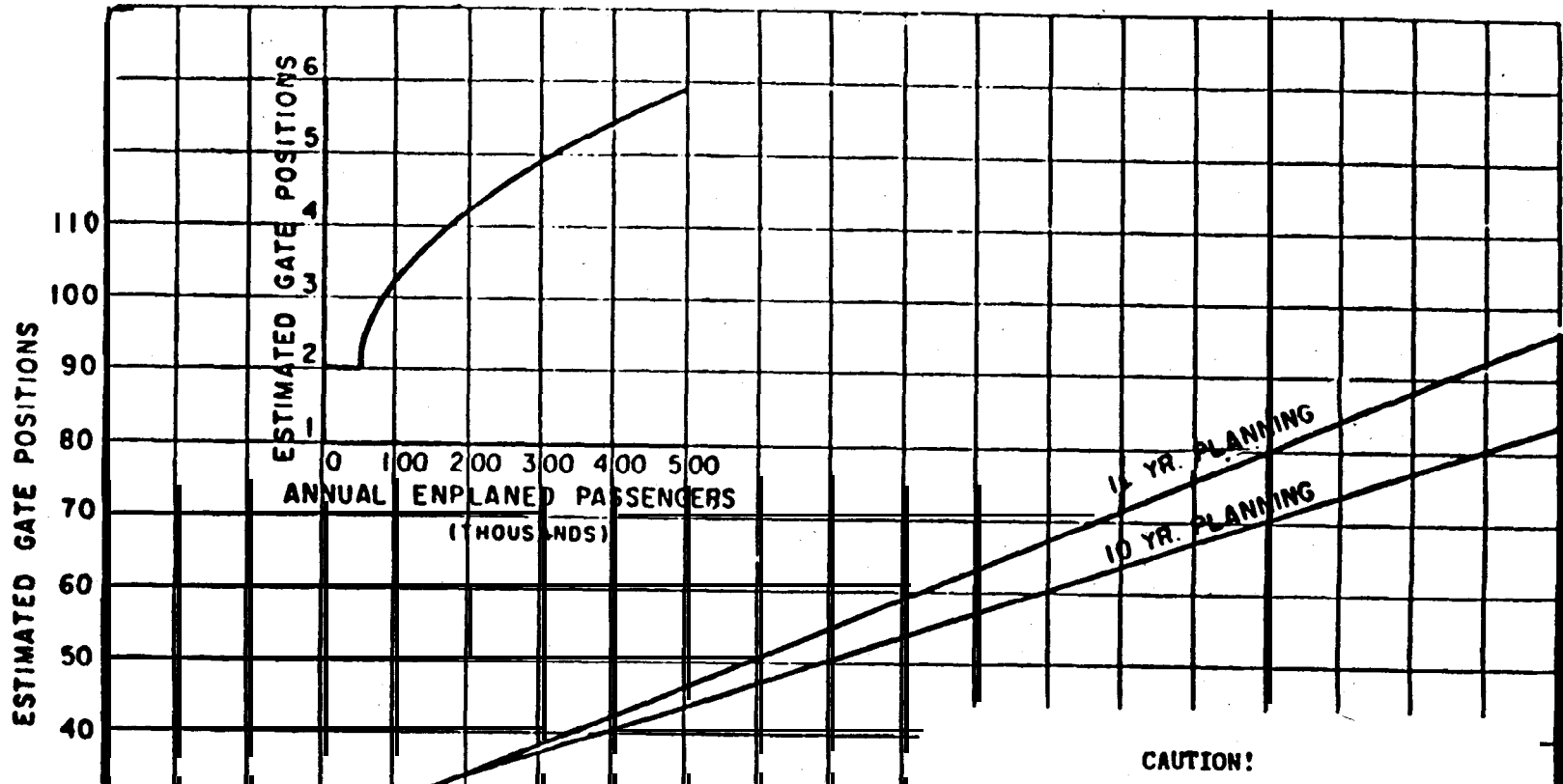

d. **Aircraft Extremity to Building Clearances.** A 20 feet (6 m) value is satisfactory, except that 45 feet (14 m) should be provided for inboard pier gates.

e. **Gate Sizing.** At very high activity airports, airlines will often segregate gates by assigning their use to one or several aircraft types. This permits the airline to design the gate position and provide appropriate service equipment to meet the needs of **specific** aircraft. At the less active airports, such segregation is often impractical and the gates serve a variety of aircraft types. In sizing a gate position, the planner/designer should first ascertain the anticipated type(s) of aircraft which will use the gate and the docking procedure to be used. Gates serving a variety of aircraft, should be designed for the largest expected aircraft. Taxi-in, push-out/power-out gates are generally the easiest to size, since the critical dimensions are limited to aircraft length, wingspan, and appropriate clearances. In designing a taxi-out gate, such additional factors as aircraft maneuverability (turning radii), jet blast, and parking angle **require** consideration.

f. **Gate Position Layout.** Figures 4-6 through 4-12 illustrate some typical gate position layouts. Airplane characteristics manuals published by aircraft manufacturers should be consulted to determine the precise aircraft turning radii associated with taxi-out gate positions.

46. **TAXILANES.** Taxilanes are used on aprons by aircraft taxiing between taxiways and gate positions. The required taxilane object free area (OFA) widths (refer to AC 150/5300-13) and provision of dedicated rights-of-way for apron service vehicle roads affect the minimum spacing between parked aircraft and between pier fingers. Both single and dual taxilanes are used **between** pier fingers, depending on the pier lengths and number of aircraft positions. When a dual taxilane is under consideration, the frequency of use by each aircraft type, as well as the number of aircraft parking positions on each side, should be considered. As a rule, a row of four aircraft on each side will not require a dual taxilane. For larger arrangements, a detailed analysis of aircraft movements and traffic delays may be necessary. Figure 4-13 provides dimensioning information on pier separation with single and dual taxilanes. Figure A9-4 in AC 150/5300-13 illustrates apron taxilane layouts with provision of dedicated space for service vehicle roads.

47. **APRON GRADIENTS.** For fueling, ease of towing, and taxiing, apron gradients should be kept to the minimum, consistent with local drainage requirements. The slope should not exceed 1.0 percent and should be directed away from the face of the terminal. Refer to AC 150/5300-13 for further guidance.

48. **AIRCRAFT PARKING GUIDANCE SYSTEMS.** Aircraft parking guidance systems are usually a visual aid to the pilot for final parking of aircraft in the gate position. These visual aids are **either** painted guidelines on the apron or mechanical or light-emitting guidance devices mounted at cockpit height on the facing structure. Systems using lights are **becoming more** popular. Lights are used to inform the pilot of the aircraft's location with **respect** to the centerline position desired and when to stop the aircraft at the desired nose-to-building distance. Apron installed switching devices are occasionally **required** at the final nosewheel location. Refer to AC 120-57, Surface Movement Guidance and Control System, and the related reading material **cited therein** for additional guidance.

49. **LOADING BRIDGES.** At very low activity airports, passengers usually board aircraft using integral aircraft stairs or mobile passenger stairs. At more active airports, the use of passenger loading bridges is quite common. Two types of loading bridges are illustrated in Figure 4-14. They are used for boarding passengers from an upper level and have many possible design variations. At some airports, loading bridges are employed to load passengers from grade level by constructing a stairway or ramp connection at the loading bridge entrance. Some characteristics of loading bridges which influence terminal design are discussed as follows:

a. The primary constraint in **considering passenger** boarding now rates normally is one of three elements: the entrance doorway to the loading bridge; the aircraft door; or the aircraft aisle width. If stairs are used at the loading bridge entrance, a fourth constraint is added. The width of the loading bridge usually is not a constraining factor.

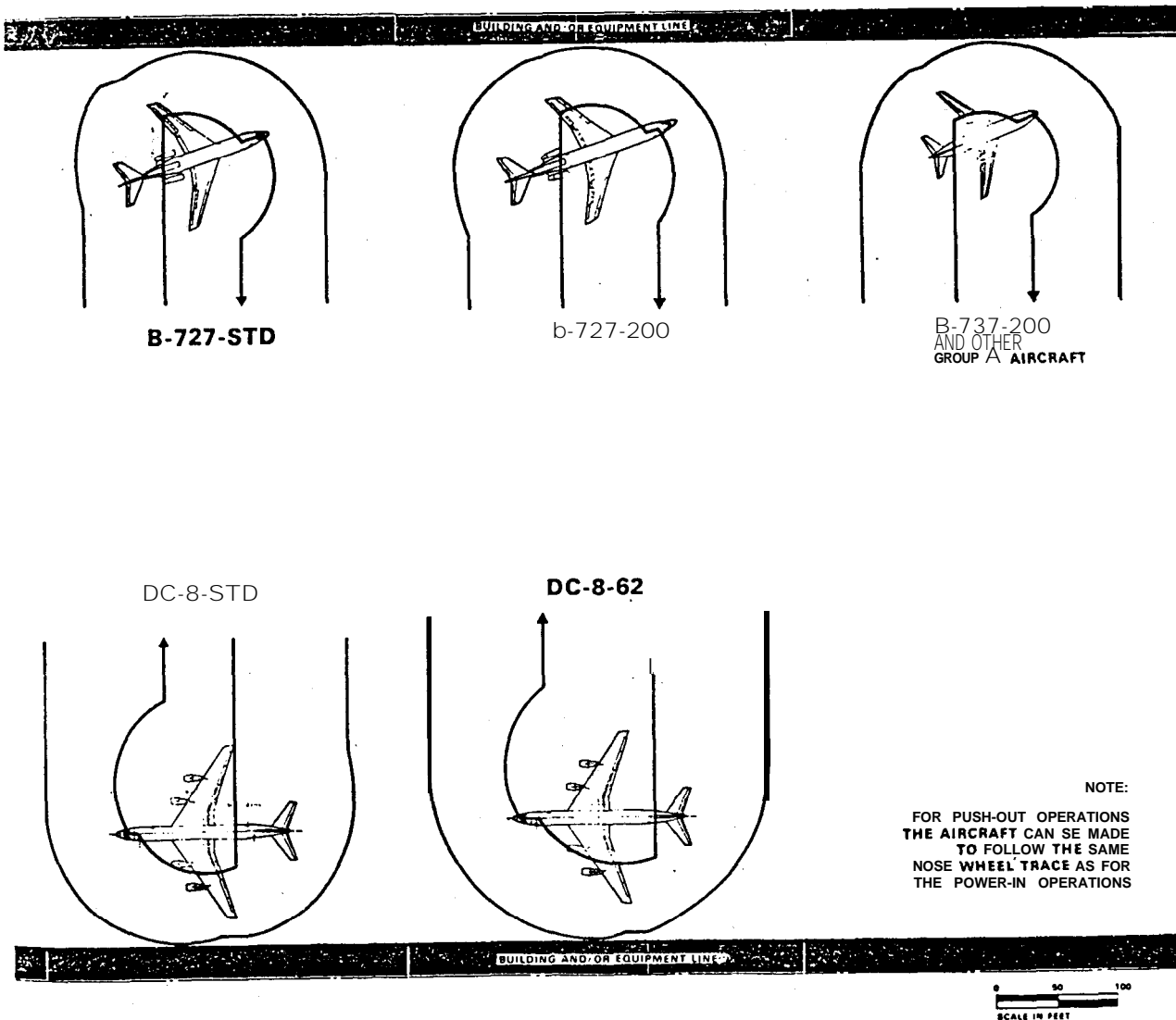

Figure 4-6. Aircraft Maneuvering Area Taxi-Out Configuration

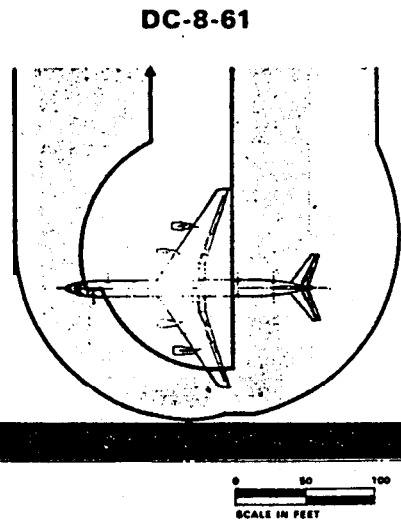
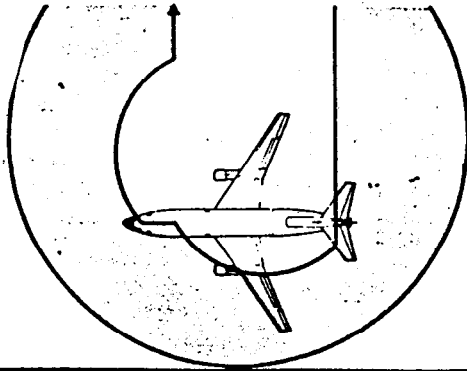
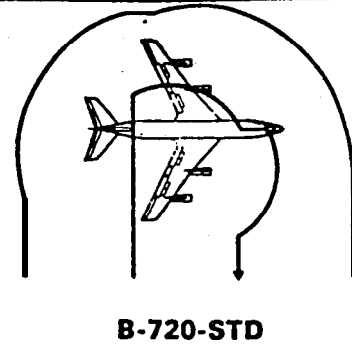
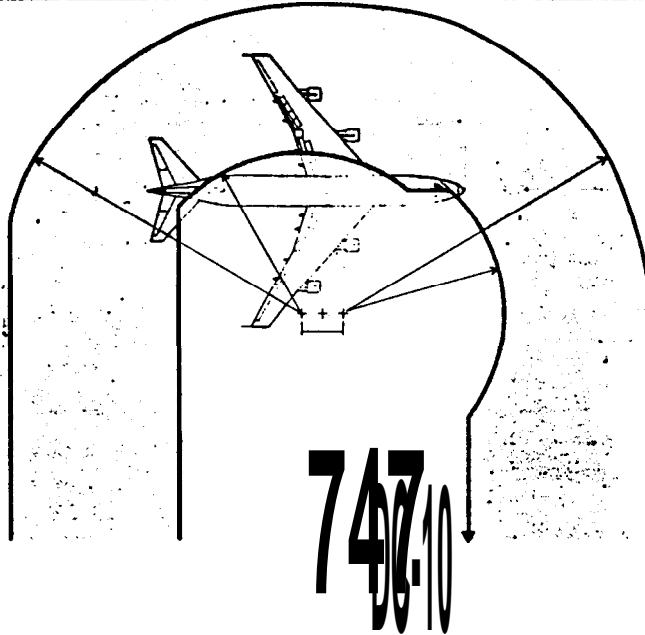
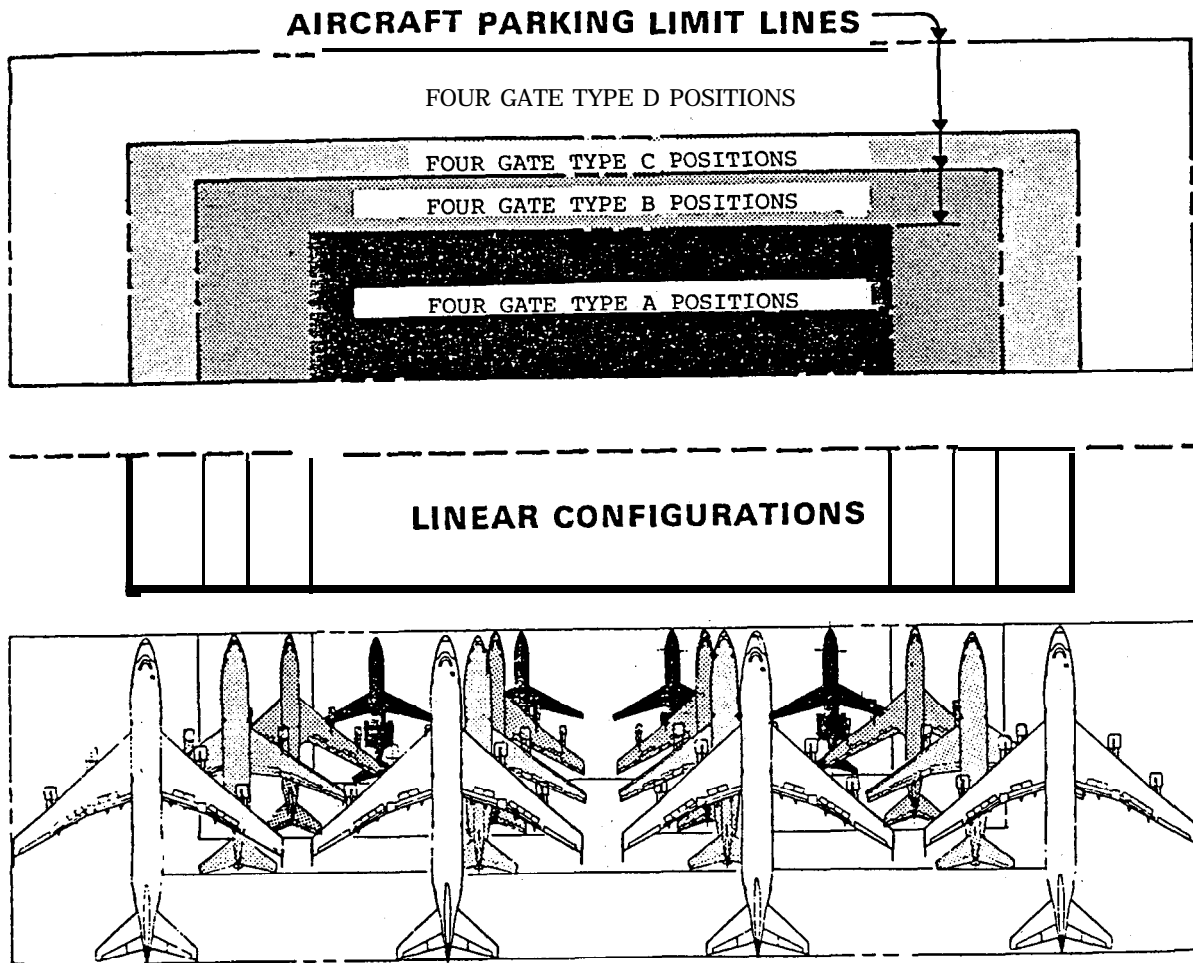

Figure 4-7. Aircraft Maneuvering Area Taxi-Out Configuration



ALL WINGTIPS SHOW
20-FT CLEARANCE

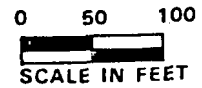

Figure 4-8. Linear Configuration Pushout Gate Positioning

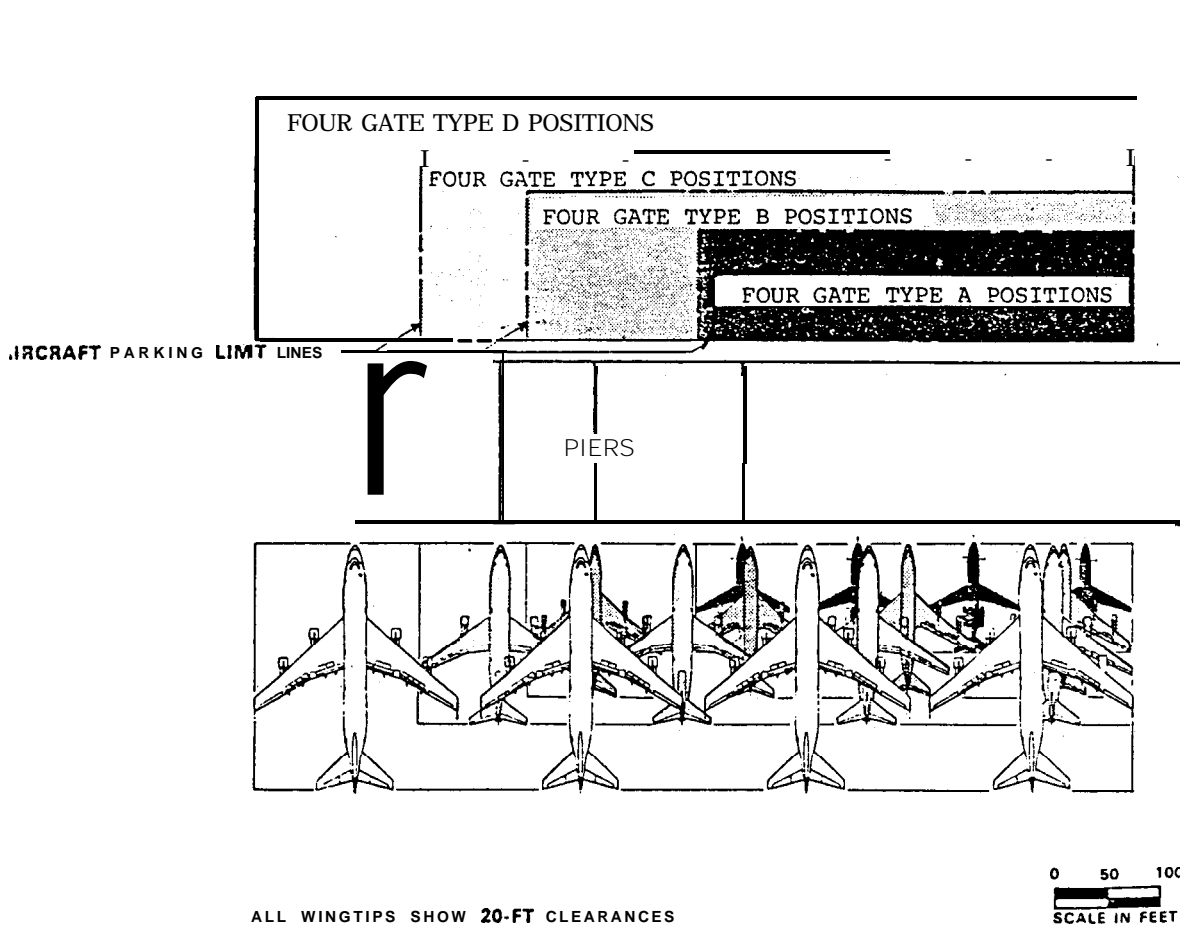

Figure 4-9. Pier Configuration Pushout Gate Positioning

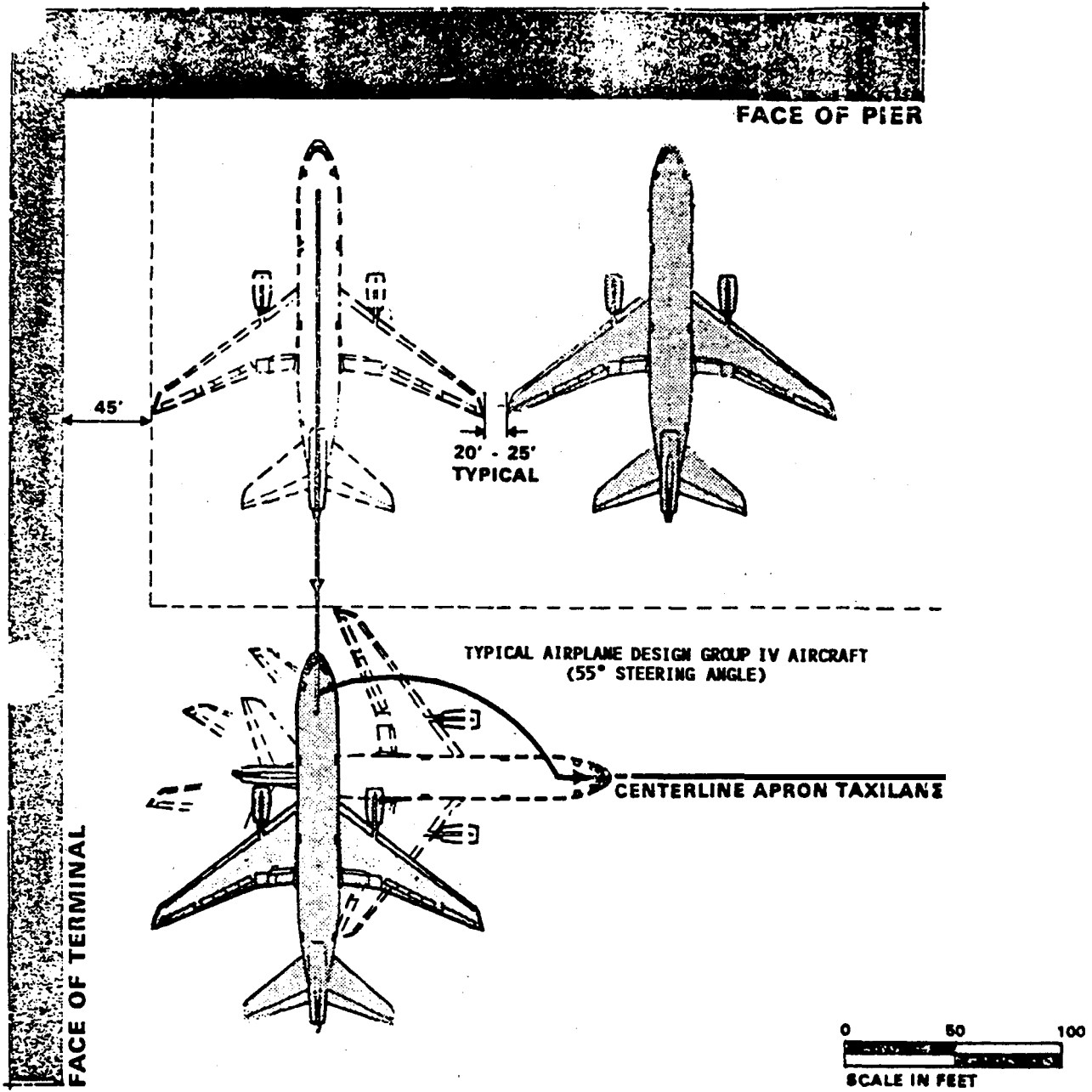

Figure 4-10. Typical Clearances--Inboard Pier Gate

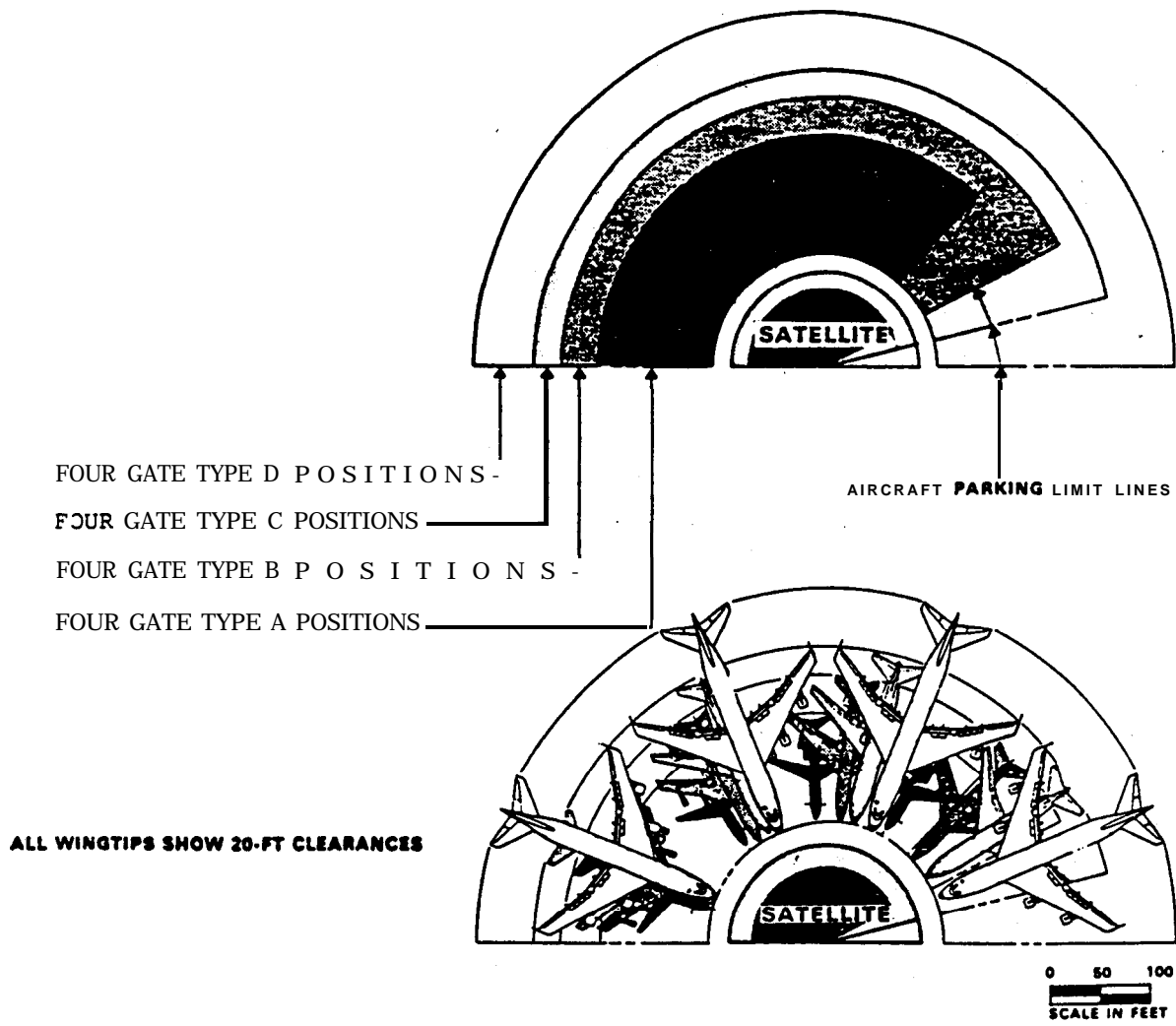
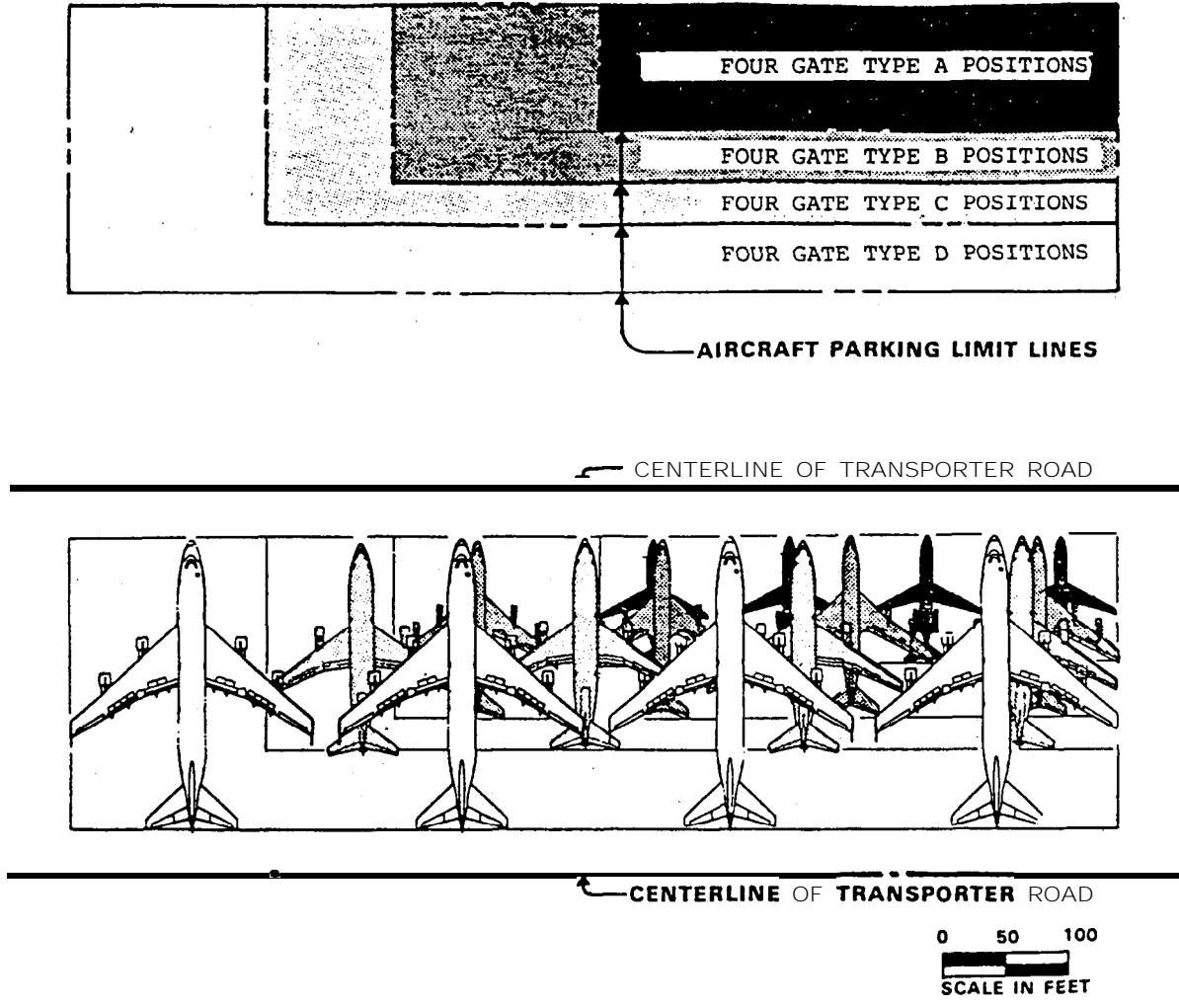

Figure 4-11. Satellite Configuration Pushout Gate Positioning



ALL WINGTIPS HAVE **45-FT** CLEARANCE
FOR TRANSPORTER MANEUVERING

FOR SERVICE BUILDINGS
SEE CHAPTER 3, CONNECTOR ELEMENT

Figure 4-12. Transporter Configuration Taxi-Through or Pushout Gate Positioning

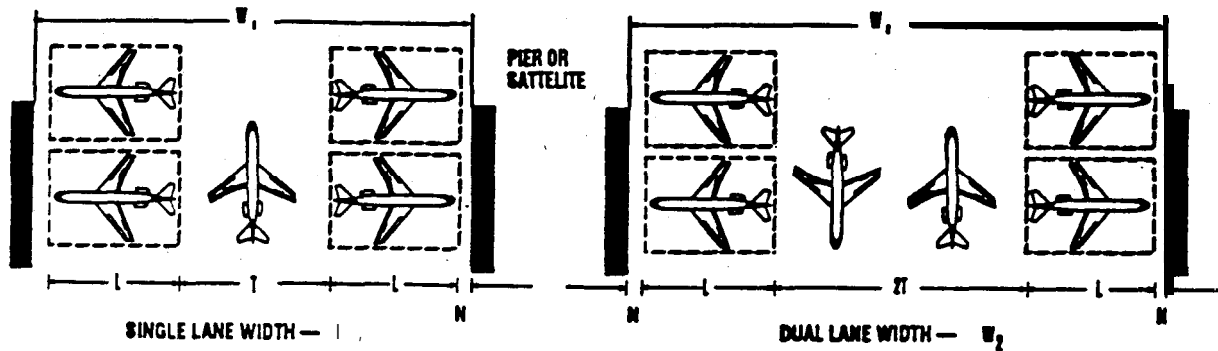

Gate Type	(N) Nose to Bldg. Distance	(T)* Taxilane OFA Width	(L) Airplane Length	(W ₁)* (2N+T+2L)	(W ₂)* (2N+2T+2L)
A	30 ft/9 m	162 ft/49 m	155 ft/47 m	532 ft/162 m	694 ft/212 m
B	20 ft/6 m	225 ft/49 m	160 ft/49 m	585 ft/179 m	810 ft/247 m
C	20 ft/6 m	225 ft/49 m	188 ft/57 m	641 ft/195 m	866 ft/264 m
D	15 ft/4.5 m	276 ft/84 m	232 ft/71 m	770 ft/235 m	1.046 ft/319 m

Note: Service vehicle roads on aprons are located outside of the taxilane object free area (OFA), and must be accounted for as a separate entity in determining W_1 or W_2 . (See Figure A9-4, AC 150/5300-13.)

Figure 4-13. Dual- vs. Single-Taxilane Layout

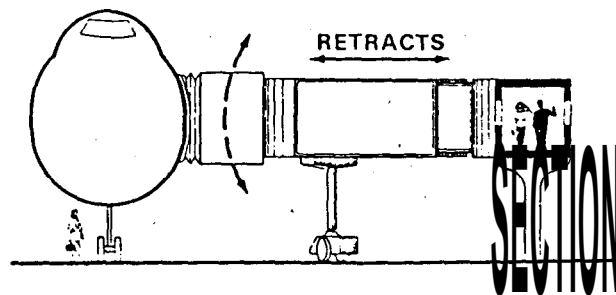
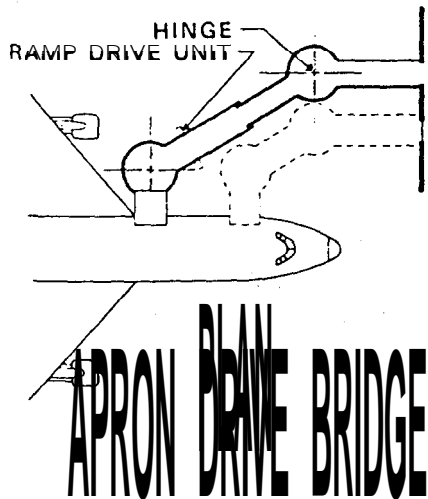
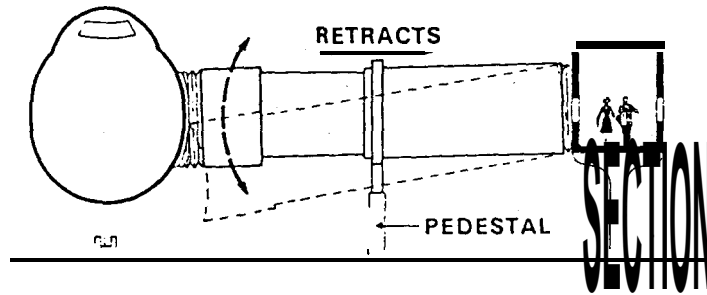
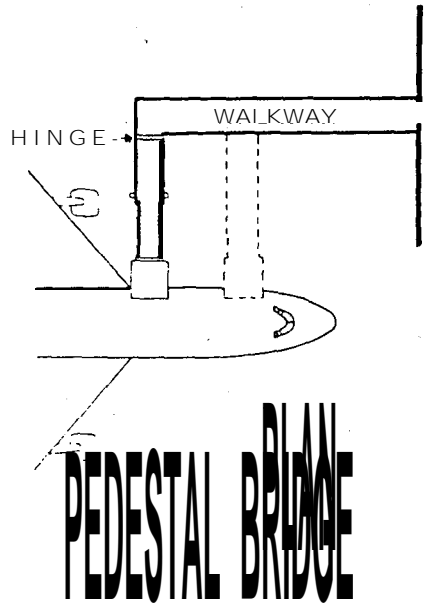

Figure 4-14. Typical Passenger Loading Bridges

b. Aircraft door widths **range** from 32 **inches** (84 cm) to 42 **inches** (107 cm). **Their** respective flow rates are **approximately** 25 passengers and 40 passengers **per** minute. A 36-inch (91 cm) **entrance** doorway accommodates approximately 37 passengers **per** minute.

c. Since aircraft aisle width can influence **the** flow **rate** of a loading bridge. Airline studies indicate a flow rate of 30 passengers **per** minute for a single-aisle aircraft.

d. A stairway at the **loading bridge entrance** reduces flow rates to **approximately** 20-25 **passengers** per minute, **the** same rate **achieved** when integral aircraft or **mobile** stairs are employed. A stairway or ramp not constructed within the terminal building should be provided with an **enclosure** for weather protection.

e. The maximum ramp **gradient** to comply with **Americans** with Disabilities Act (ADA) requirements is **1:20**.

f. The length and type of loading **bridge** (**fixed** pedestal, apron **drive**, or suspended) are functions of a number of variables. These **include** apron dimensions, airline docking procedures, wingspan, door locations, fixed aircraft services, **adjacent** aircraft positions, and economics. For instance, an apron drive bridge, when in a stowed position, will allow a taxi-out operation, **while** pedestal or suspended **types** are limited to **push-out** operations. A determination on which bridge **design** to apply in **each** case should be **based** on the specific characteristics of the aircraft mix as well as airline operating requirements.

g. Two loading bridges for larger **type** aircraft are **used** at some airports to facilitate loading and deplaning. In most cases, however, **one** bridge is **adequate**. The decision to **use** more than one bridge should take into account the average peak-hour "boarding" load factor by type of aircraft at each aircraft position. At through stations, it is very likely that **the** boarding load factor will be low **enough** that only one bridge will be required for a B-747 position.

h. Figure 4-15 depicts various aircraft sill heights and door locations. The positioning of an individual aircraft is, to a great **extent**, a product of its door alignment with doors of **other** aircraft types. This facilitates the utilization of one type of loading **bridge** to **serve** a variety of aircraft. **However**, this is not the only consideration to be met in determining the interchangeability of a series of aircraft **parked** on one apron area. Normally, an apron area will be **restricted** for various reasons to a **limited** number of usually similar aircraft types. This greatly **simplifies** loading-bridge **maneuvering** requirements, as **well** as the positioning of fixed utilities.

i. Designers should be aware of **the** National Fire Protection Association (NFPA) **criterion** (refer to paragraph 2-2.6 of NFPA 417, Standard on Construction and Protection of Aircraft Loading Walkways) which stipulates that any door in the **egress** path through the loading walkway to the terminal building swing in the direction of egress from the aircraft towards the **terminal** building and be **equipped** with panic hardware on the aircraft side.

50. TRANSPORTERS.

a. Transporters are used at some airports to carry **passengers** between the terminal building and remotely parked aircraft. A nonelevating transporter may simply be a bus or similar vehicle, possibly modified for airport use. A stair boarding device is required to **complement** its operation for passenger boarding, crew access, cabin service **access**, and emergency egress. This type of vehicle is generally more appropriate for use on an interim basis or to **supplement** gate loading during **very heavy peak** periods. Elevating transporters are designed to mate with **the** terminal dock and aircraft for loading and unloading passengers. One type of elevating transporter uses an **elevating** gangplank with a 6 to 10 foot (1.8 to 3 m) extension which adjusts to various aircraft sill heights. This **type** generally has a capacity of 50-80 passengers. Another type uses an elevating passenger compartment or pod and a loading **bridge-type** coupling to ensure compatibility with practically all aircraft **currently** used by airlines. This **vehicle** generally has a capacity of 55 to 120 passengers.

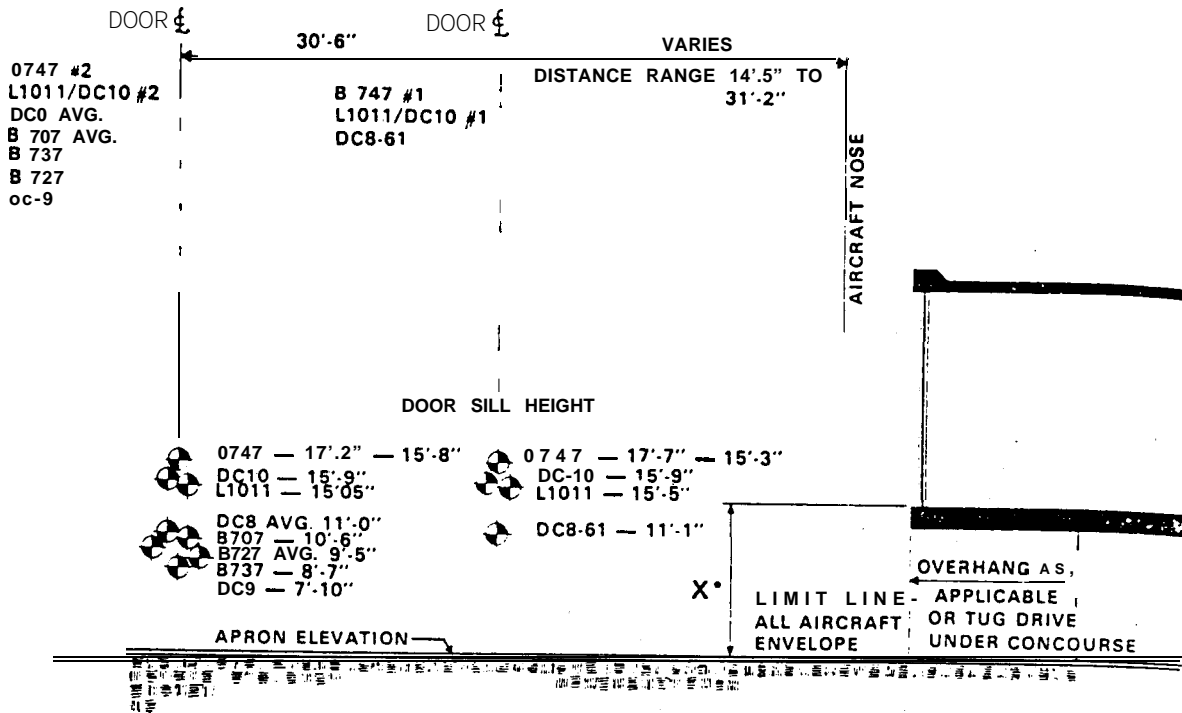

*X AVERAGE FLOOR. HEIGHT DEPENDS ON:
 (A) A/C TYPES
 (B) # DOOR SERVE
 (C) LOADING BR. TYPE USED

Figure 4-15. Aircraft Sill Heights

b. The number of transporters and docks required can be determined by developing and analyzing an aircraft flight-line scheduling plan and determining transporter cycle times for peak periods. The flight line scheduling plan includes arrival and departure times and ground time for each aircraft during peak periods for the projected design year. Transporter cycle time is defined as the time for the transporter to complete a cycle from dock to aircraft to dock. It is dependent on transporter average speed (generally from 8 to 15 miles per hour), the travel distance between terminal and the aircraft parking area, and vehicle maneuverability and docking procedures. Cycle time also depends on the **efficient** organization of the transporter operation. For instance, a transporter which has completed enplaning one flight at the flight line can position for an arriving flight without returning to the dock. Thus, the normal cycle has been interrupted, a new cycle established, time saved, and a more efficient operation promoted. Such interrupted cycle times are accountable in determining transporter requirements. Consideration for peaks within peaks is also required if

unacceptable de'lays are to be avoided. For **example**, 50 percent of a peak hour's traffic volume may occur in 15 or 20 minutes, thereby **overloading** the system. Figure 4-16 **provides** a nomograph for estimating transporter requirements. The nomograph can be **used** in the **early stages** of planning to **determine** general requirements. Design **requirements** will necessitate **the** more precise analysis discussed previously. At the higher activity locations, simulation models may be necessary to test future **schedules**, variations in transporter runs, cycle times, and other alternatives.

51. FIXED UTILITIES. Figure 4-17 **depicts** the most common **fixed** utilities located at aircraft parking positions; namely, fueling and power systems. Optimum locations are shown for most aircraft in the U.S. air carrier fleet. Descriptions and **uses** of several of the **more** common fixed utilities are as follows:

a. Fueling. The advantages of underground fueling systems are the reduction in the amount and size of ground equipment and corresponding decrease in ramp congestion with large numbers of aircraft during the design hour. Primarily, a shift from fuel trucks to an underground system is **justified** on a cost versus volume basis. A further development of a pure underground system for each aircraft position is a common hydrant fueling point in proximity to several aircraft. In such a system, hydrant fueling trucks are used instead of large-capacity tankers. In both cases, however, trucks are required. With underground fueling, fuel is pumped from a central tank farm to a pit. The hydrant truck then connects a hose to the pit and into the aircraft. The maximum allowable fuel-truck hose lengths vary between 30 and 50 feet (9 and 15 m). AC 150/5320-4, Aircraft Fuel Storage, Handling, and Dispensing, provides additional relevant guidance.

b. Water. The **fixed** water supply at each gate position is usually an easily **adapted fixed** utility. Most existing terminal configurations, **where** aircraft park next to the building structure, are already supplied with potable water. Provided that capacities are adequate, this supply may be tapped and linked to the aircraft with a hose-reel cart.

c. Ground Power. Providing a fixed ground power unit for **each** gate position may be desirable. Recently, the approach has **been** simply to provide a ground power source with the loading bridge (**apron-drive** or fixed pedestal). This eliminates additional ramp congestion (cables, etc.) or more costly underground installations. Power requirements for each aircraft position vary and should be justified on an individual airline basis.

d. Air Start. Pressurized air is required for aircraft without an auxiliary power unit (APU). Although it is the **least** commonly available **fixed** utility, it can be **permanently** installed in a **manner** similar to other utility systems. In actual practice however, truck-mounted units are by far the most commonly used to provide this service. The air requirements for various aircraft range from 120 to 270 **lb/min.** (54.5 to 122.7 **kg/min**) at 40 psi (275.8 **kPa**).

e. Air Conditioning. An option exists for airlines to elect to introduce **fixed** air-conditioning units on the apron. **However**, **APU-supplied** air conditioning and **centrally furnished** low pressure preconditioned air are most commonly used.

52. APRON AREA LIGHTING. Most outdoor areas associated with the apron require some degree of illumination. Table 4-1 presents criteria for lighting in foot-candles (**lux** (lx)) for apron/apron related areas. Lighting levels should be of sufficient intensity to allow observation of **all** pedestrian activity. Mounted floodlights are the usual preferred method of lighting the apron area. They are typically mounted at a height of 25 to 50 feet (8 to 15 m) with a maximum spacing of 200 feet (60 m). Floodlight location requires coordination with the specific type(s) of aircraft using the parking position. Floodlights should be aimed and shielded to avoid glare to pilots and air traffic controllers without reducing the **required** illumination in critical areas.

STEP 1: DETERMINE THE NUMBER OF TRANSPORTER TRIPS FOR A MIX OF AIRCRAFT

AIRCRAFT TYPE	PEAK NUMBER IN PEAK HOUR (A)	TRANSPORTERS NEEDED* (B)	NUMBER OF PEAK-HOUR TRANSPORTER TRIPS (A X B)
B-737	11	1	11
DC-10	5	2	10
B-747	6	3	18
TOTAL			39

* THIS NUMBER IS A FUNCTION OF AIRCRAFT LOAD FACTORS FOR EACH AIRCRAFT POSITION AND TRANSPORTER CAPACITY.

STEP 2: DETERMINE CYCLE TIME FOR EACH TRANSPORTER TRIP; E.G., 20 MINUTES DOCK TO DOCK.

STEP 3: READ LEFT SIDE OF GRAPH TO DETERMINE NUMBER OF TRANSPORTERS REQUIRED; I.E., 12.9 TRANSPORTERS, ROUNDED OFF TO 13

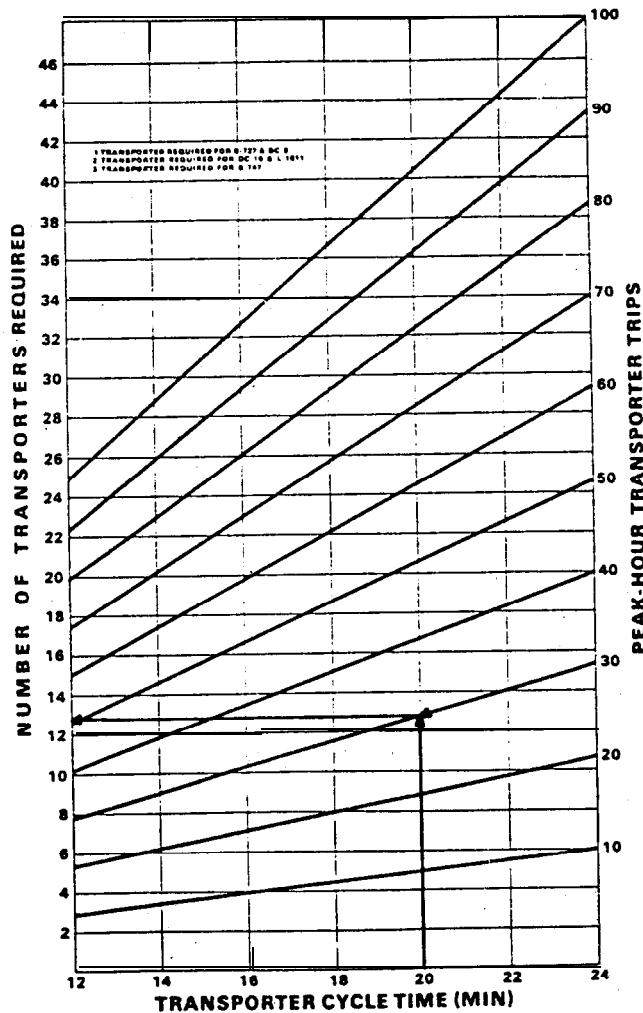

Figure 4-16. Transporter Requirements

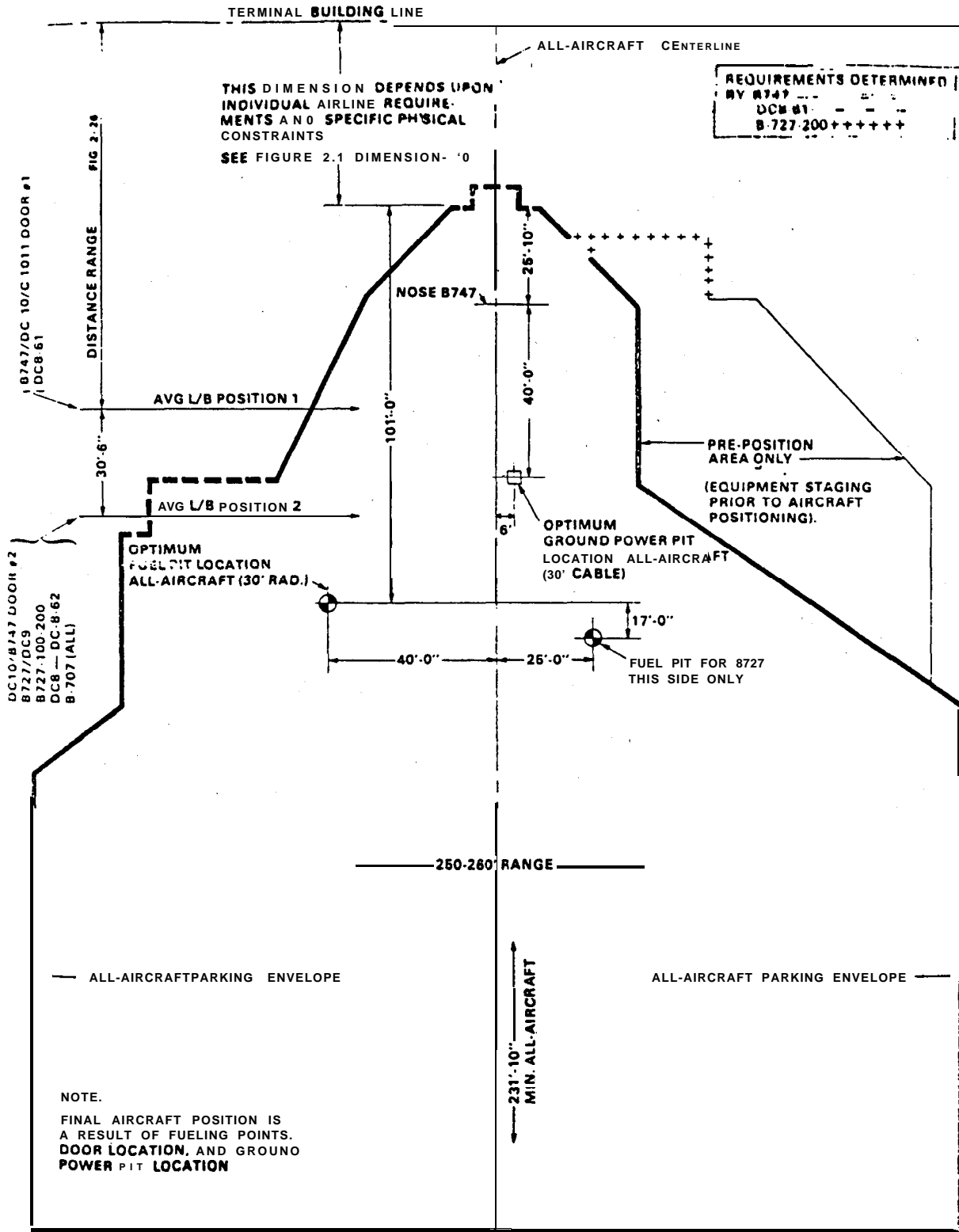

Figure 4-17. Common Fixed Utility Locations - Composite Aircraft Parking Envelope

Table 4-1. General Lighting Requirements

Area	Foot-candles (LX) ²
Fences, gates, guard-shelters, building exteriors, apron areas, associated equipment parking areas, building entrances, and exits.	5.0 (54.0)
Pedestrian entrances to aircraft operations area ¹	2.0 (22.0) max.
General aircraft operations area ¹	0.15 (1.6)
Dock Areas	10.0 (108.0)
Roadways	1.5 (16.0)

¹ FAA AC 107-1, Aviation Security-Airports.

² Measured at most remove points of areas involved, ± 200 ft (60 m) 36 inches (91 cm) above ground; light target perpendicular to the direction of the light rays.

53. BLAST FENCES. Passenger and aircraft servicing facilities ground equipment should be located in areas not affected by aircraft engine blast. Blast fences are often used on terminal aprons to protect ground equipment, personnel, buildings, or other **aircraft** from aircraft blast, particularly when aircraft taxi to and from gate parking positions. They may also be used in push-out/power-out **configurations** where blast is a potential problem. The positioning of blast fences depends on aircraft or ground-equipment maneuvering patterns, while their size depends on the extent of blast requiring control. Chapter 6 of AC 150/5300-12 discusses aircraft jet blast and the design and location of blast fences.

54. - 65. **RESERVED.**

CHAPTER 5. TERMINAL BUILDING SPACE AND FACILITY GUIDELINES

66. GENERAL. This chapter provides guidance on spatial requirements for functions carried out in an airport terminal building. The guidance is indicative of the design range in use at U.S. airports to accommodate domestic scheduled passenger operations. Adjustments may be necessary for international, charter, non-scheduled, or third level operations. Airport terminals should be designed for a capacity to meet the projected needs of the community being served. This guidance should only be applied after consultation with the airlines, FAA, other users, and tenants. Modifications to the guidance may be warranted after such discussions.

67. GROSS TERMINAL BUILDING AREA ESTIMATES.

a. Gross Terminal Area Per Gate. The relationship between annual **enplaned** passengers and gross terminal area per gate for a 10-year and 20-year forecast is approximated in Figures 5-1 and 5-2, respectively. The profile of the curves is based on predicted growth in seats per aircraft for each forecast period; specifically, the growth in predicted aircraft mix during the peak hour of the average day of the peak month of the design year. With a 10 or 20 year forecast of annual enplanements and an approximate required number of gates determined by the procedures discussed in paragraphs 25 through 27, an approximation of gross terminal area can be made.

b. Rule-of-Thumb. A rule-of-thumb of about 150 square feet (14 m²) of gross terminal building area per design peak-hour passenger is sometimes used for rough estimating purposes. Another rule using 0.08 to 0.12 square feet (0.007 to 0.011 m²) per annual enplanement at airports with over 250,000 annual enplanements can similarly be applied. At small airports with less than 250,000 enplanements, estimates should be based on peak hour considerations and simple sketches (see AC 150/5360-9).

68. SPACE ALLOCATIONS. The terminal building area is comprised of both usable and unusable space. Unusable space involves those areas required for building columns and exterior and interior walls, about 5 percent of the total gross area. The usable space can be classified into the two broad categories of rentable and nonrentable space. Usually, 50 to 55 percent is allocated to rentable space and 45 to 50 percent to nonrentable space. Figure 5-3 presents a further breakdown of these basic categories.

69. PUBLIC LOBBY AREAS. Lobbies provide public circulation and access for carrying out the following functions: passenger ticketing; passenger and visitor waiting; housing concession areas and other passenger services; and baggage claim.

a. Ticketing Lobby.

(1) As the initial objective of most passengers, the ticketing lobby should be arranged so that the enplaning passenger has immediate access and clear visibility to the individual airline ticket counters upon entering the building. Circulation patterns should allow the option of bypassing counters with minimum interference. Provisions for seating should be minimal to avoid congestion and encourage passengers to proceed to the gate area.

(2) Ticket lobby sizing is a function of total length of airline counter frontage; queuing space in front of counters; and, additional space for lateral circulation to facilitate passenger movements. Queuing space requires a minimum of 12 to 15 feet (4 to 5 m). Lobby depths in front of the ticket counter range from 20 to 30 feet (12 to 15 m) for a ticket area serving 50 gates or more.

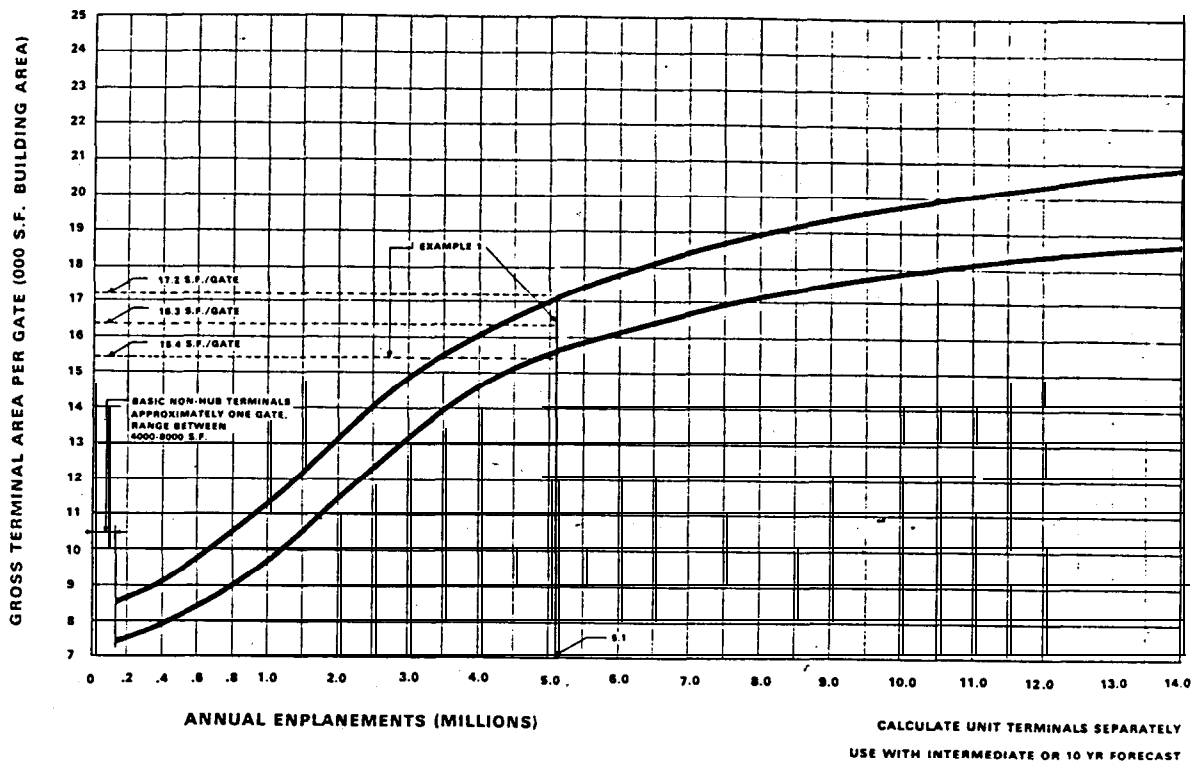

Figure 5-1. Gross Terminal Area Per Gate - Intermediate Planning

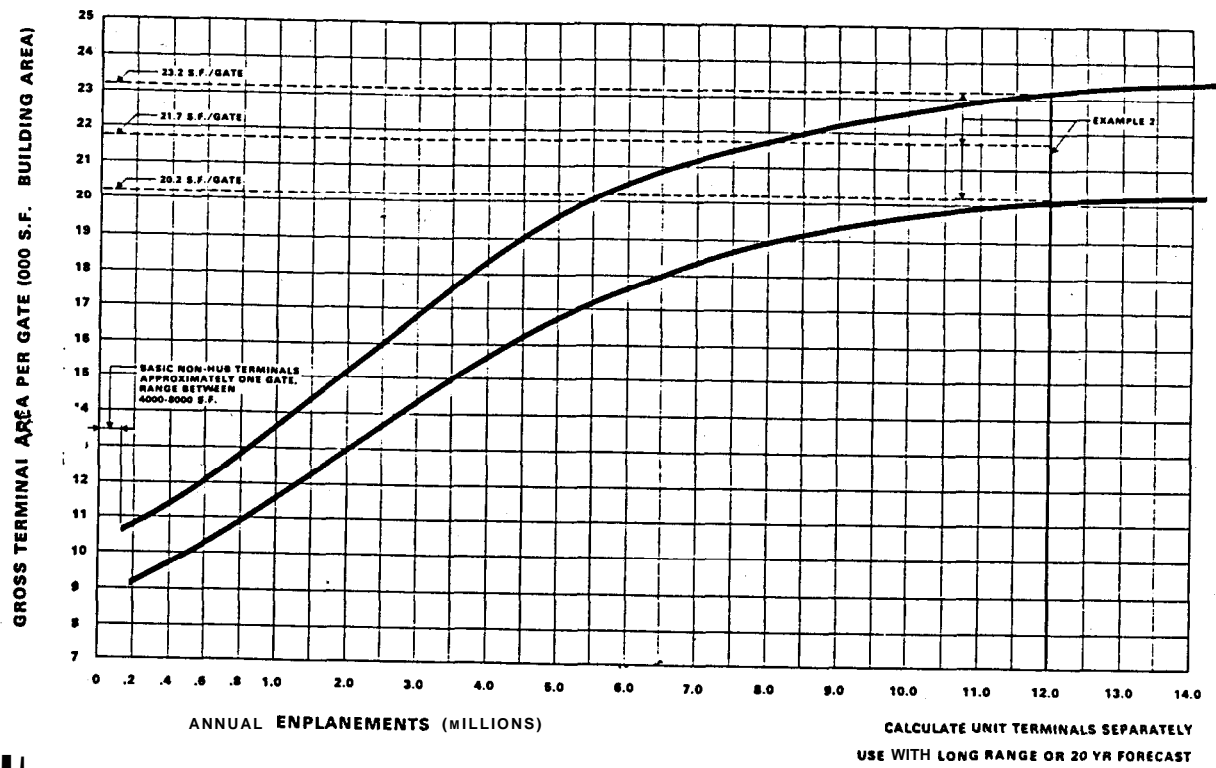

Figure 5-2. Gross Terminal Area Per Gate - Long-Range Planning

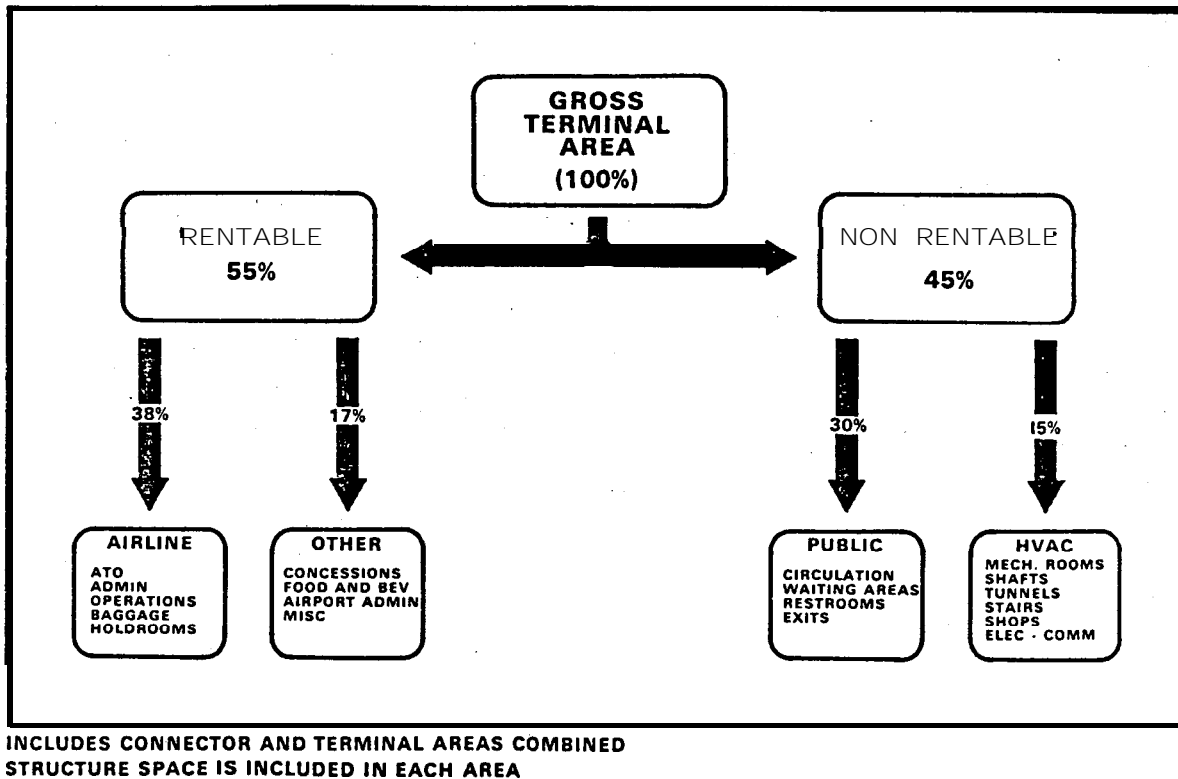

Figure 5-3. Gross Terminal Area Space Distribution

(3) Figure 5-4 contains a nomograph for approximating ticket lobby area for initial planning purposes. This nomograph includes the ticket counter and area behind the ticket counter as part of the lobby area. It is necessary to subtract the counter area when estimating only the public lobby area used for passenger queuing and circulation. Inventories at some existing large hubs indicate that additional area to that shown in the figure should be provided at the extreme ends of the ticket counters for additional circulation.

b. Waiting Lobby.

(1) Apart from providing for passenger and visitor circulation, a centralized waiting area usually provides public seating and access to passenger amenities, including rest rooms, retail shops, food service, etc. The sizing of a central waiting lobby is influenced by the number, seating capacity, and location of individual gate waiting areas. If all gate areas have seating, the central waiting lobby may be sized to seat 15 to 25 percent of the design peak hour enplaning passengers plus visitors. However, if no gate seating areas are provided or planned, seating for 60 to 70 percent of design peak hour enplanements plus visitors should be provided.

(2) Visitor-passenger ratios are best determined by means of local surveys. In the absence of such data, an assumption of one visitor per peak hour originating passenger is reasonable for planning purposes.

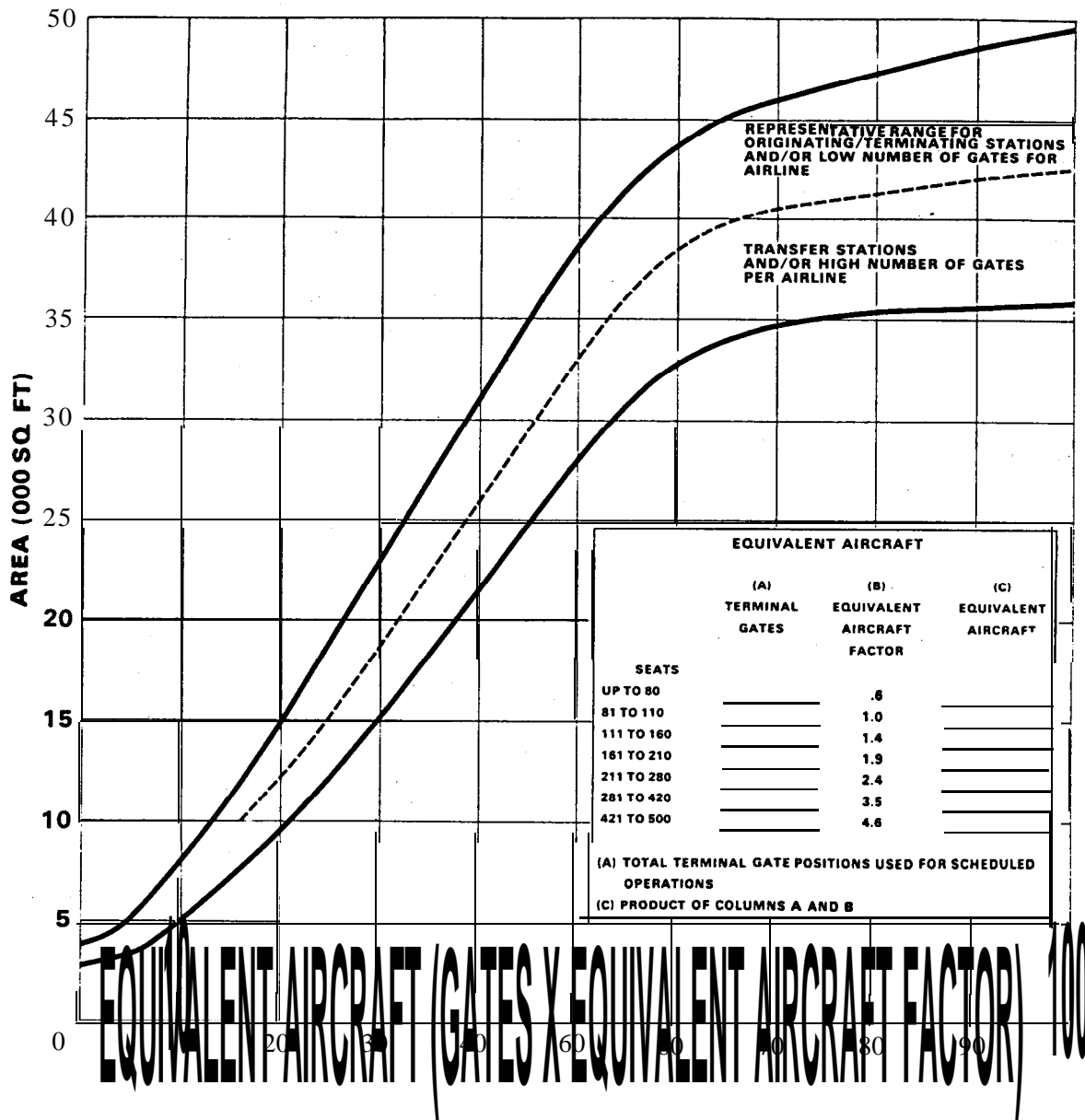

Figure 5-4. Ticket Lobby and Counter Area

(3) Figure 5-5 may be used as an approximation for converting seating requirements to lobby area. The area obtained from this nomograph provides for circulation around two sides of seating. Additional area is required for circulation around three sides.

c. Baggage Claim Lobby.

(1) This lobby provides public circulation space for access to baggage claim facilities and for egress from the claim area to the deplaning curb and ground transportation. It also furnishes space for such passenger amenities and services as car rental counters, telephones, rest rooms, limousine service, etc.

(2) Space required for the baggage claim facility is discussed in paragraph 75. Allowance for public circulation and passenger amenities outside the claim area ranges from 15 to 20 feet (5 to 6 m) in depth at

small hub airports, 20 to 30 feet (6 to 9 m) at medium hubs, and 30 to 35 feet (9 to 11 m) at those airports serving large hubs. Lobby lengths range from 50 to 75 feet (15 to 23 m) for each baggage claim device. For approximating lobby length and area, one claim device per 100 to 125 feet (30 to 38 m) of baggage claim frontage should be assumed.

d. Combined Lobbies.

(1) Airports handling less than 100,000 annual enplanements frequently provide a single combined lobby for ticketing, waiting, and baggage claim. Figure 5-5, with an assumed seating for 100 percent of peak hour enplanements, may be used to obtain a gross approximation for lobby space. This usually allows adequate space for visitors and circulation. Also, AC 150/5360-9 presents space requirements for low activity airports.

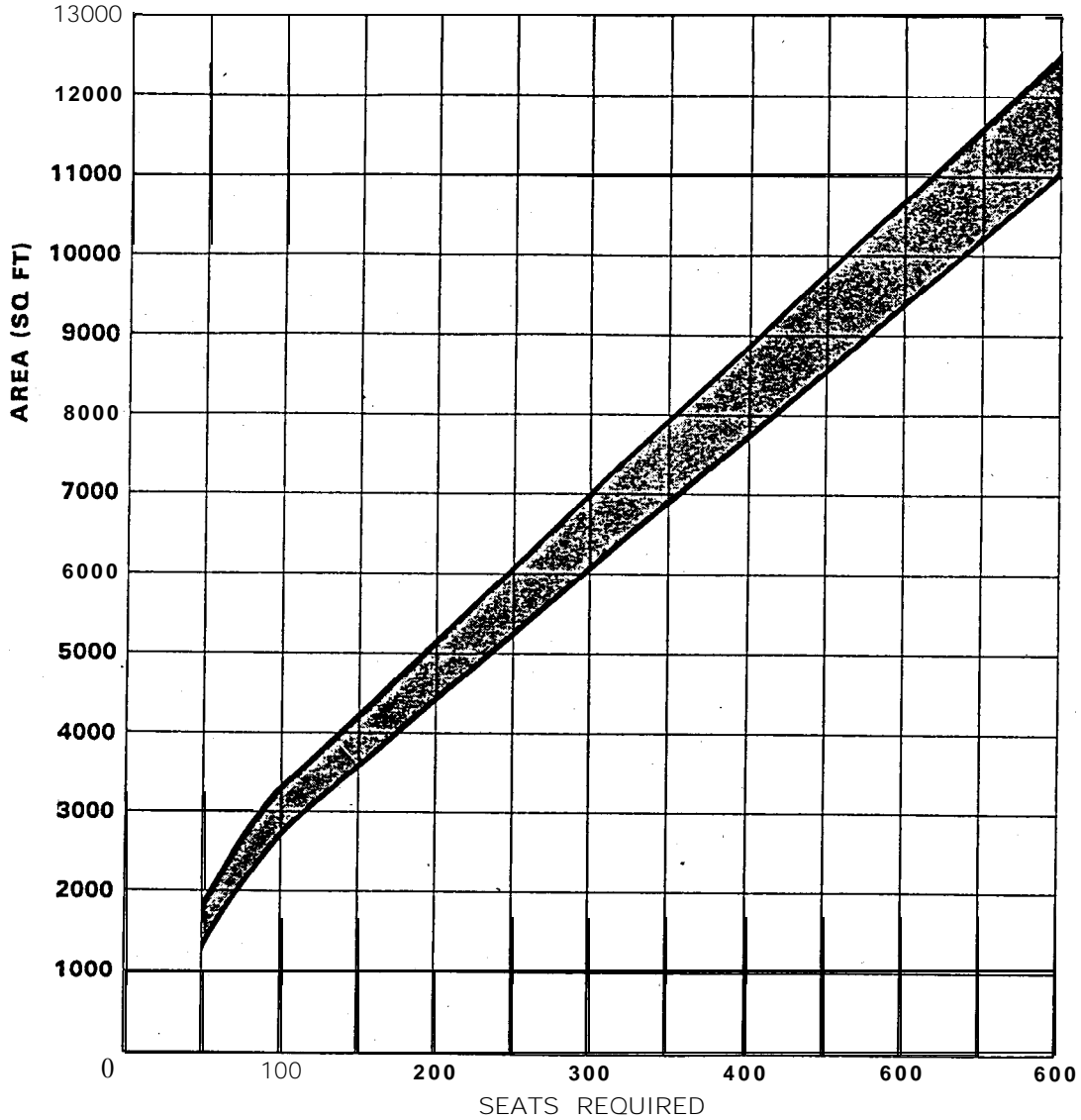

NOTE:
FOR REQUIREMENTS
OVER 600 SEATS,
USE MULTIPLES OF 200
OR MORE

GRAPH INCLUDES
PRIMARY CIRCULATION AREAS
FROM COUNTERS TO
CONCESSIONS, CONNECTOR,
ETC.

Figure 5-5. Waiting Lobby Area



For a combined lobby serving 100,000 to 200,000 annual enplanements, space requirements for various functions should be identified and sized separately, as discussed in preceding paragraphs.

(3) Above 200,000 annual enplanements, each of the three lobby types should be identifiable as distinct elements and space requirements estimated accordingly.

70. AIRLINE TICKET COUNTER/OFFICES. The Airline Ticket Counter (**ATO**) area is the primary location for passengers to complete ticket transactions and check-in baggage. It includes the airline counters, space and/or conveyors for handling outbound baggage, counter agent service areas, and related administrative/support offices. In almost all cases, ticket counter areas are leased by an airline for its exclusive use. Therefore, the planning, design, and sizing of these areas should be closely coordinated with individual airlines.

a. Ticket Counter Configurations. Three ticket counter configurations are in general use. They include:

(1) **Linear.** Linear configuration is the most frequently used one (see Figure 5-6). Multi-purpose positions indicated are those in which the agent performs several functions such as ticketing, baggage check-in, and the other services an airline may consider appropriate. During peak periods, multi-purpose positions may be utilized for a single function to expedite passenger processing for those requiring only one type of service. At high volume airports, permanent special-purpose positions may be justified.

(2) **Flow-through Counters.** Flow-through counters, as depicted in Figure 5-7, are used by some airlines, particularly at high-volume locations with a relatively high percentage of "baggage only" transactions. This configuration permits the passenger to check-in baggage before completing ticketing transaction and increases outbound baggage handling capability by providing additional belt conveyors. This type of counter requires more floor space, an additional 50-70 square feet (4.7-5.1 m²), than the linear type and involves increased investment and maintenance costs. Future application will probably be limited to relatively few airports.

(3) **Island Counters.** The island counter shown in Figure 5-8 combines some features of the flow-through and linear arrangements. The agent positions form a "U" around a single baggage conveyor belt (or pair of belts) permitting interchangeability between multipurpose or specialized positions. As with flow-through counters, this configuration has relatively limited application.

b. Office Support. The airline ticket counter/office provides space for a number of airline support activities. These activities include: accounting and safekeeping of receipts; agent supervision; communications; information display equipment; and personnel areas for rest, personal grooming, and training. At low activity locations, the ticket counter area may provide space for all company administrative and operational functions, including outbound baggage. Figure 5-9 depicts two typical layouts for low activity airports with single-level terminals. At high activity locations, there is more likelihood that additional space for airline support activities will be remotely located from the ticket counters.

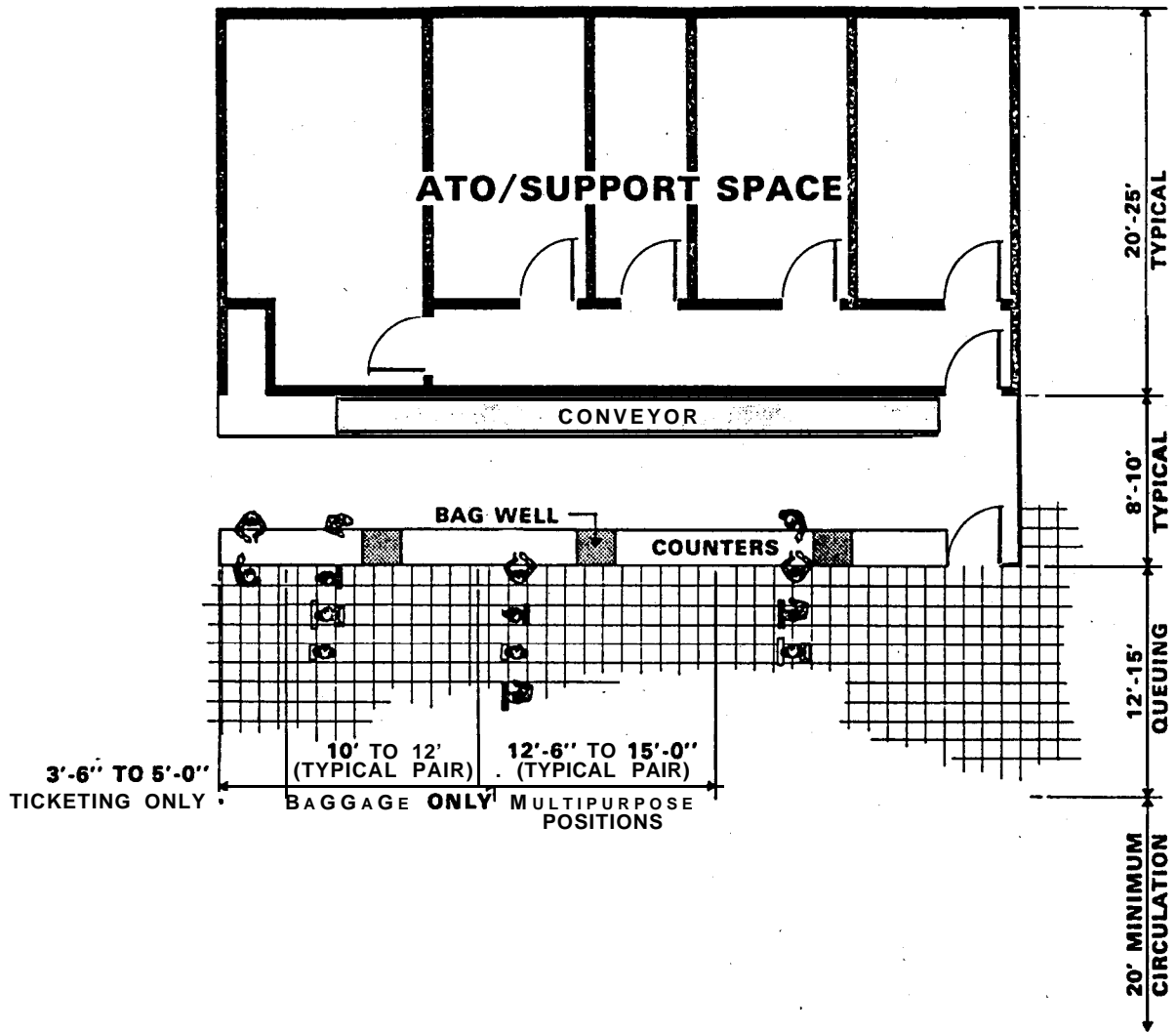

Figure 5-6. Linear Counter

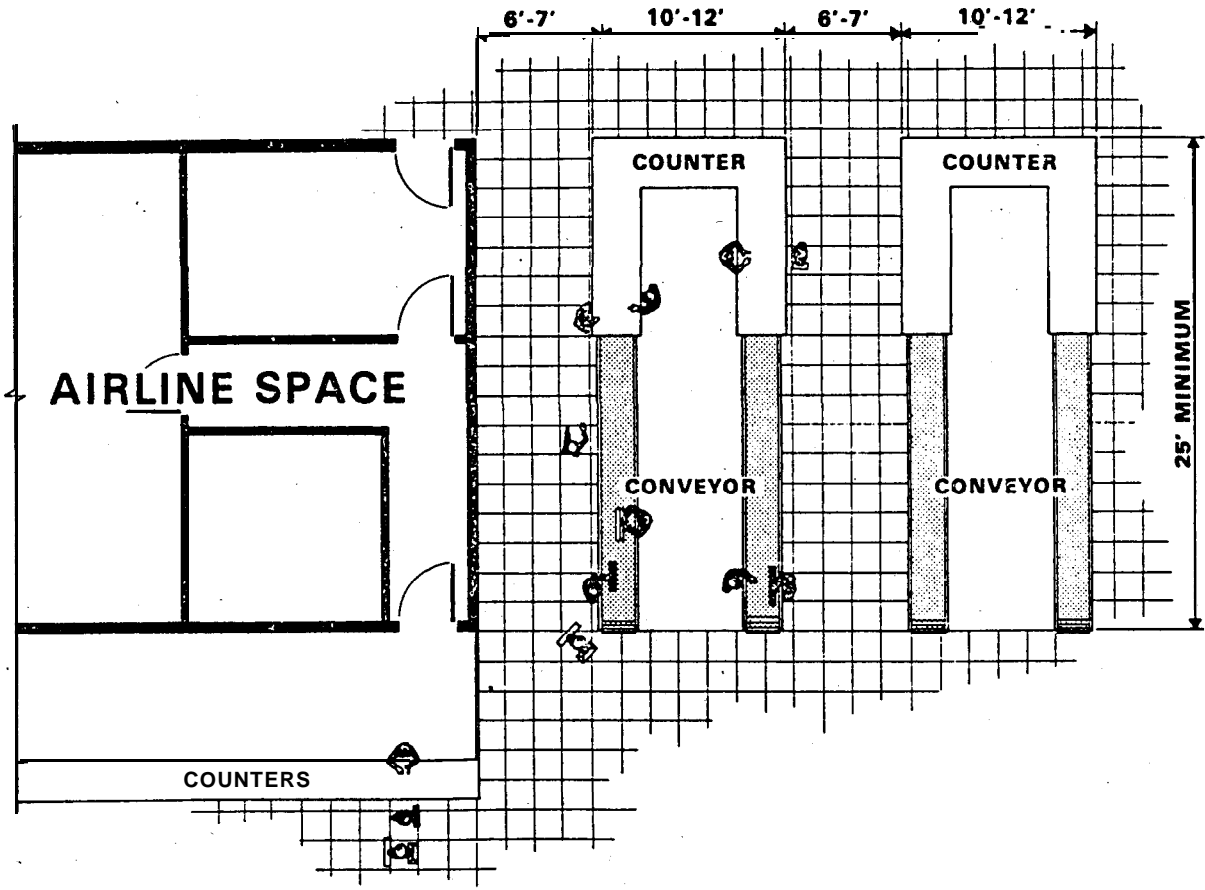

Figure 5-7. Flow-Through Counter

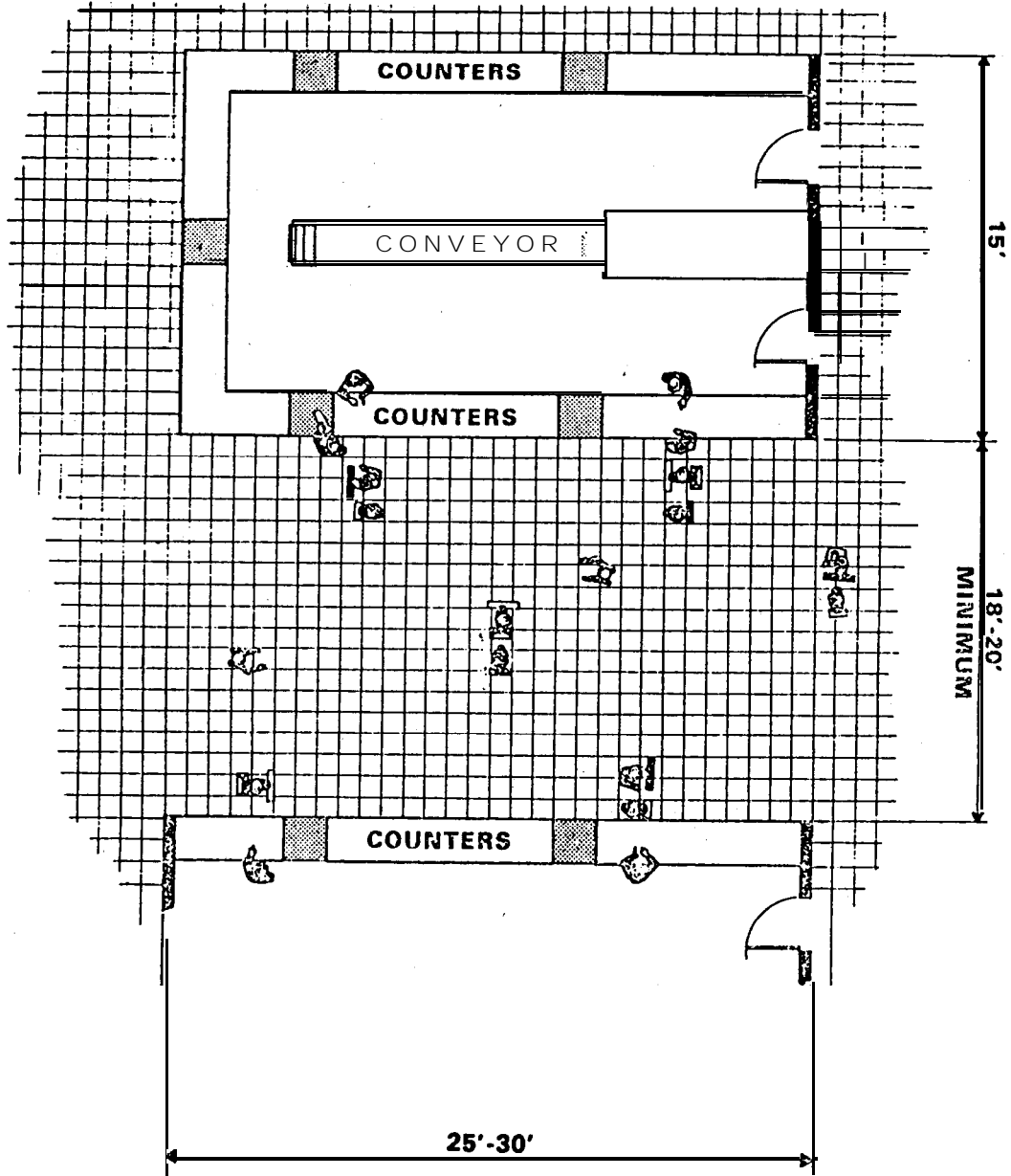

Figure 5-8. Island Counter



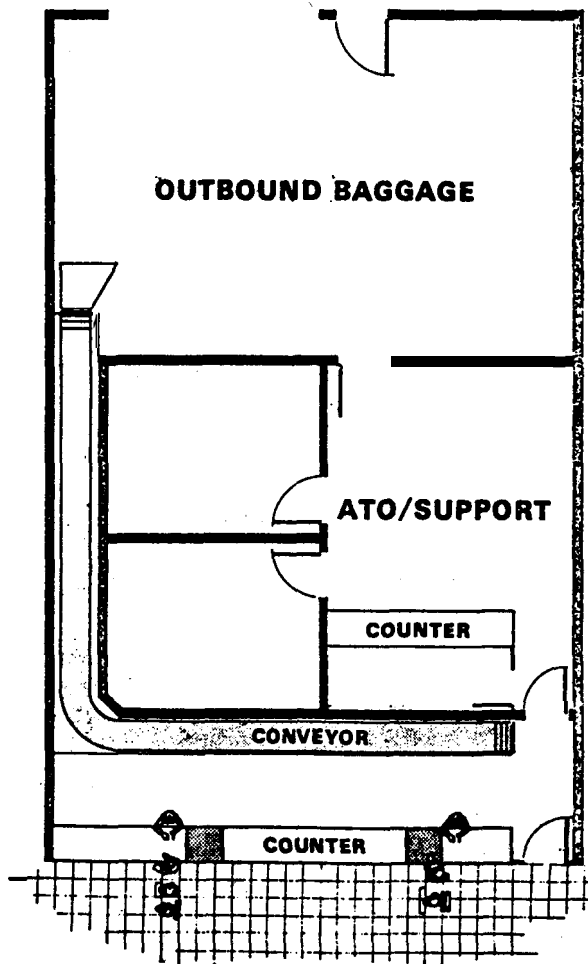
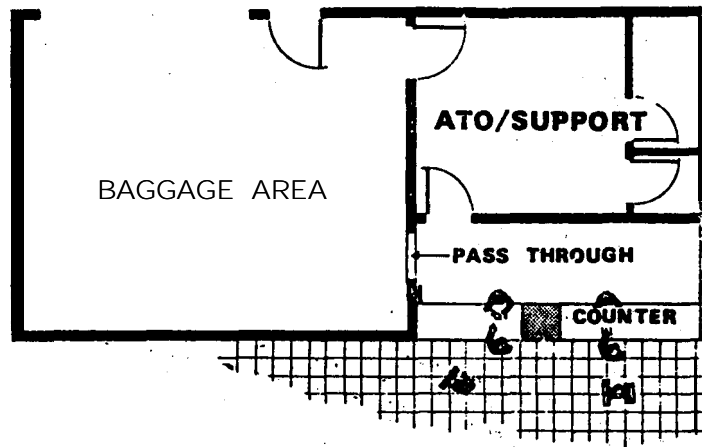

Figure 5-9. Typical AT0 Layouts - Single-Level Terminals

c. **Sizing.** Figure 5-10 may be used in estimating airline ticket counter frontage for the three counter configurations previously discussed. It utilizes the EQA factors discussed in paragraph 25. The frontage obtained from the chart is based on counter positions typically required for airline peaking activities. The values determined from the chart do not include conveyor belt frontage at flow-through counter configurations. Less frontage may be required when individual airlines provide curbside check-in and ticketing at gates: In determining the counter working area, the frontage obtained from the chart is multiplied by a depth of 10 feet (3 m). Figure 5-11 shows typical ranges of ATO support space. This is presented separately from counter working area since many of these support functions are remotely located at higher activity locations. For gate or gate equivalents exceeding those shown in this figure, quantities appropriate to the separate lobbies or sections of lobbies, unit terminals, and the like, should be used. This normally occurs at airports with over 50 gates.

71. OUTBOUND BAGGAGE FACILITIES.

a. The outbound baggage facility is that area where baggage is received by mechanical conveyor from the ticket counters, online and offline connecting flights, and curbside check-in. It is sorted and loaded into containers or carts for subsequent delivery to aircraft. At low-volume airports, bags may be manually moved through a wall opening.

b. At most airports, outbound baggage areas are located in building spaces leased by the tenant airlines for exclusive use. Each airline provides its own baggage processing equipment and conveyors. The outbound baggage area should be located in reasonably close proximity to the ticket counters to facilitate the movement of baggage between these locations. The area should also have convenient access to the aircraft parking apron by means of carts or other mobile or mechanical conveyors.

c. On-line and inter-line transfer baggage is best handled in the same area with other outbound baggage for optimal use of personnel, space, and equipment. An area or conveyor for receiving transfer baggage from other airlines should be considered. Often, this area is adjacent to a primary traffic aisle. Security for delivered baggage makes a conveyor or pass-through into the outbound baggage area advisable. At stations where the airlines contract with a third party for all interline deliveries, a pick-up area for baggage to be delivered to other carriers should be provided with similar provisions for baggage security and control.

d. Since outbound baggage area requirements are determined by individual airline policy, early input from the airlines is essential. The minimum size for an outbound baggage room is approximately 400 to 450 sq. ft. (37 to 42 m²) per airline. Figures 5-12 and 5-13 can be used for initial estimating of outbound baggage area requirements. These nomographs were developed on the basis of an average of 1.3 bags checked per passenger. Caution should be used in applying these nomographs as substantial variance in the number of bags per passenger at different airports can range from 0.8 to 2.2. Business passengers will usually average less than 1.3, whereas vacationers needs may be substantially greater.

e. At locations where an airline proposes using some type of automated sorting, additional area to that indicated in Figure 5-13 will be necessary. The required area should be increased by at least 150 to 200 percent for tilt-tray sorting systems and 100 percent for destination-coded vehicle systems.

f. Following are some common types of outbound baggage equipment:

(1) **Belt conveyors** represent the most commonly used mechanized component for baggage systems, operating at speeds of 80 to 150 fpm (25 to 46 mpm) over short distances, and providing transport capacities of 26 to 50 bags per minute.

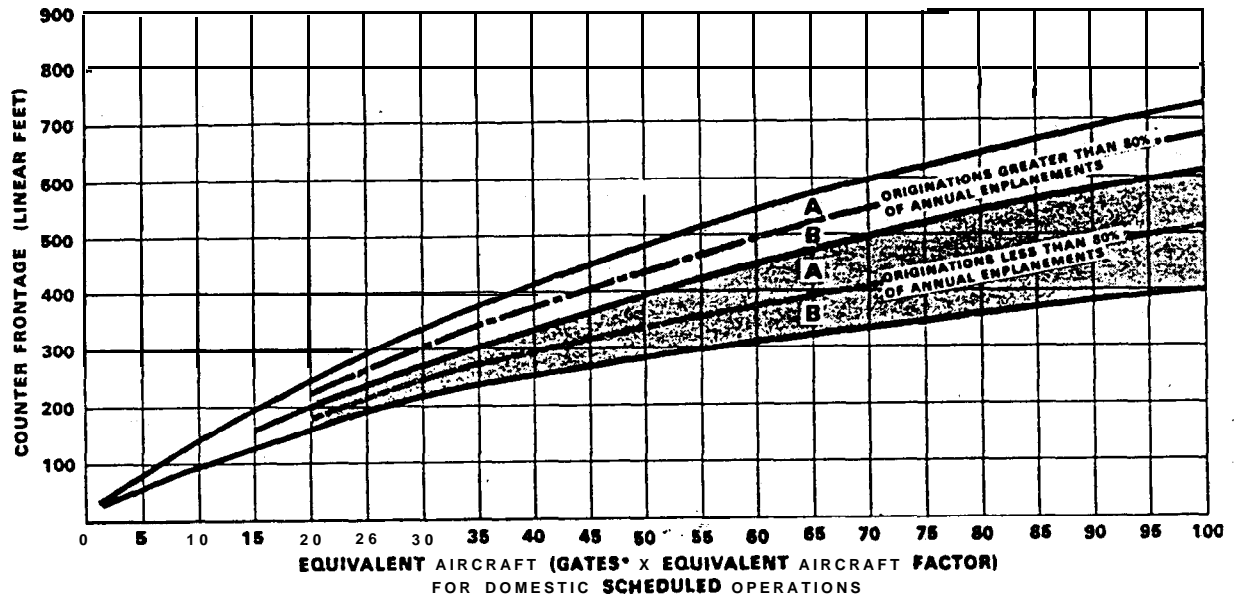

EQUIVALENT AIRCRAFT			
	(A) TERMINAL GATES	(B) EQUIVALENT AIRCRAFT FACTOR	(C) EQUIVALENT AIRCRAFT
SEATS			
UP TO 80	_____	.8	_____
81 TO 110	_____	1.0	_____
111 TO 160	_____	1.4	_____
161 TO 210	_____	1.9	_____
211 TO 280	_____	2.4	_____
281 TO 420	_____	3.6	_____
421 TO 800	_____	4.6	_____
(A) TOTAL TERMINAL GATE POSITIONS USED FOR SCHEDULED OPERATIONS			
(C) PRODUCT OF COLUMNS A AND B			

(A) TYPICAL WHERE PEAK HOUR GATE UTILIZATION HAS HIGH PERCENTAGE OF DEPARTURES (EQUAL OR GREATER THAN 80% OF EQUIVALENT AIRCRAFT).
 (B) TYPICAL WHERE PEAK HOUR GATE UTILIZATION COMBINES ARRIVALS AND DEPARTURES (DEPARTURES LESS THAN 80% OF EQUIVALENT AIRCRAFT).

Figure S-10. Terminal Counter Frontage



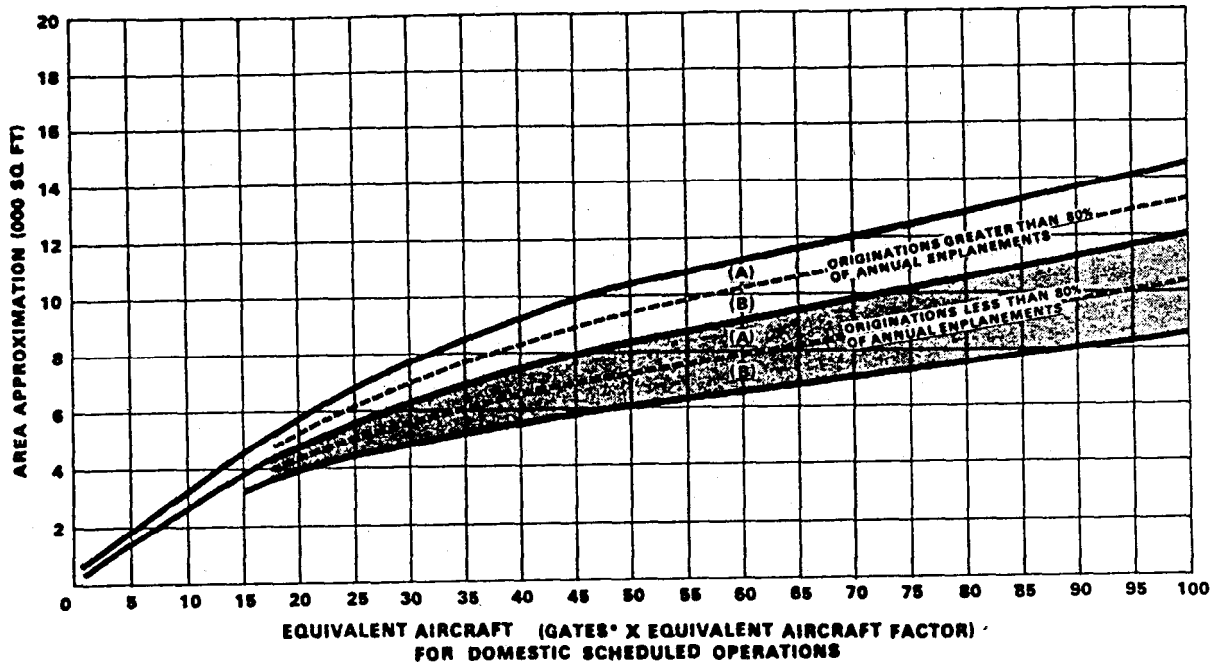

EQUIVALENT AIRCRAFT			
SEATS	(A) TERMINAL GATES	(B) EQUIVALENT AIRCRAFT FACTOR	(C) EQUIVALENT AIRCRAFT
UP TO 90	=====	.6	=====
91 TO 110	=====	1.0	=====
111 TO 190	=====	1.4	=====
191 TO 210	=====	1.9	=====
211 TO 290	=====	2.4	=====
291 TO 420	=====	3.9	=====
421 TO 800	=====	4.8	=====

(A) TOTAL TERMINAL GATE POSITIONS USED FOR SCHEDULED OPERATIONS
(C) PRODUCT OF COLUMNS A AND B

(A) TYPICAL WHERE PEAK HOUR GATE UTILIZATION WAS HIGH PERCENTAGE OF DEPARTURES (EQUAL OR GREATER THAN 80% OF EQUIVALENT AIRCRAFT).
(B) TYPICAL WHERE PEAK HOUR GATE UTILIZATION COMBINES ARRIVALS AND DEPARTURES (DEPARTURES LESS THAN 80% OF EQUIVALENT AIRCRAFT).

Figure 5-11. AT0 Office and Support Space

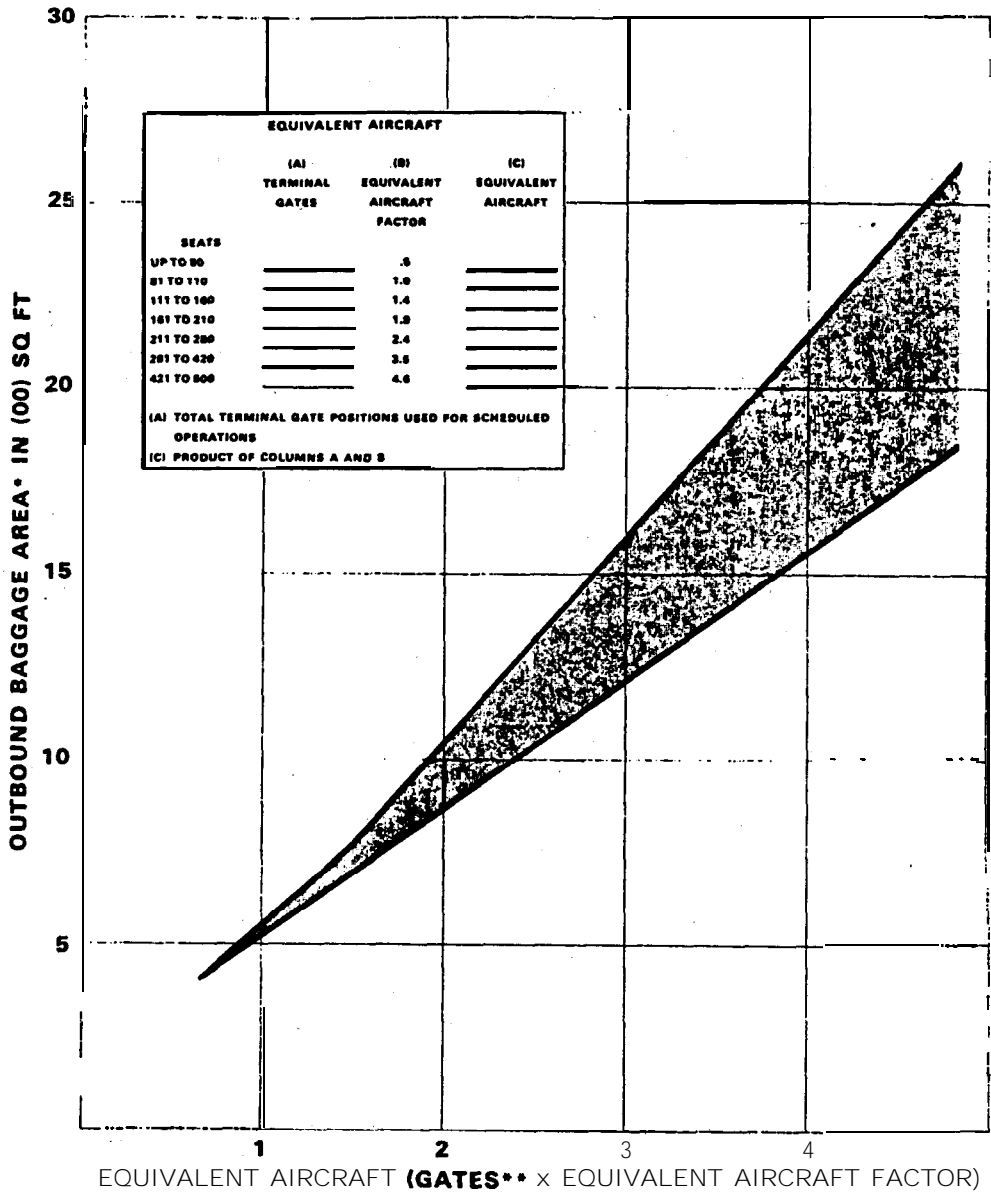

● INCLUDING CART SPACE,
BAGGAGE HANDLING EQUIPMENT,
SORTING AISLES AROUND
EQUIPMENT AND CARTS, AND
TRAFFIC LANES

EXCLUDES JOINT USE TUG DRIVE

MINIMUM SPACE REQUIREMENT
@ 400 SQ. FT

**ACTIVE LOADING POSITIONS

BASED ON 1.3 AVERAGE BAGS
PER PASSENGER.

Figure 5-12. Outbound Baggage Area - Less Than Five EQA



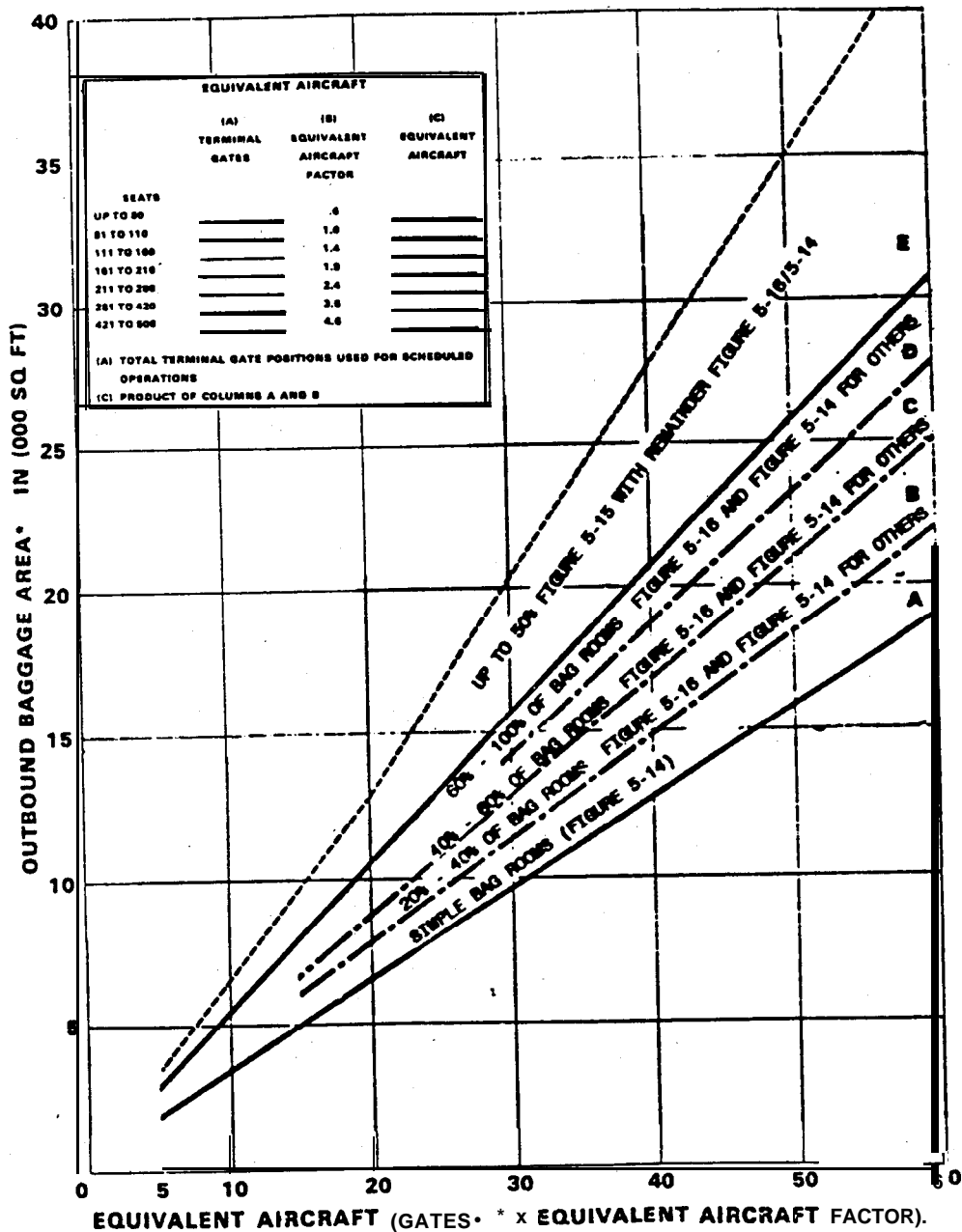

* INCLUDING CARTS AND AGGAGE HANDLING OR SORTING EQUIPMENT, SORTING AISLES AROUND EQUIPMENT AND CARTS, AND TRAFFIC LANES. EXCLUDES JOINT USE TUG DRIVE

** ACTIVE LOADING POSITIONS

BASED ON 1.3 AVERAGE BAGS PER PASSENGER.

Figure 5-13. Outbound Baggage Area - Five or More EQA

(a) Raw belt conveyors with spill plates (Figure 5-14) tend to become less efficient as the length of unloading section is increased to process simultaneous departures. In such cases, bags not removed by the baggage handler at his normal working position must be retrieved later from the end of the spill plate. That end becomes progressively more distant as the number of flights and size of aircraft increase. This condition may be alleviated somewhat by using belt conveyors with indexing features activated by photoelectric switches.

(b) Belt conveyor capacities can be increased by adding conveyors between counter inputs and outbound baggage rooms or, marginally, by merging multiple input conveyors into a higher-speed mainline conveyor. Long segments may operate at speeds up to 300 fpm (90 mpm), with acceleration and deceleration belts at each end. This represents a practical maximum for current technology and maintenance. Accordingly, high-speed belts are primarily used to reduce transport times for long conveyor runs and seldom, if ever, increase system capacity.

(2) Inclined belts, vertical lift devices, or chutes are used with baggage rooms located on a different floor level from the ATO counters. Chutes are the least expensive but lack the means for controlling baggage movement and increase the potential for damaged bags. Inclined belts should not exceed a 22-degree slope and are usually designed for 90 to 100 fpm (28 to 31 mpm) maximum. Vertical lift devices are available with capacities of 18 to 45 bags per minute.

(3) Recirculating devices for sorting and loading baggage are normally considered when the number of departures processed concurrently exceeds the practical capabilities of a raw belt and spill plate. Equipment types include belt conveyors utilizing straight and curved segments, flat-bed devices, or sloping-bed plates devices. Each of these may be fed by more than one input conveyor and may require indexing belts and accumulators to control input flow. The recirculating feature facilitates sorting bags into carts for more flights and larger aircraft by fixing relatively stationary work positions for baggage handlers with "dynamic storage" of bags until they can be sorted into carts or containers.

(4) Elongated oval configurations tend to be used in lieu of circular devices as the number of carts increases. Figure 5-15 shows carts and container dollies parked parallel to a bolt-loop or flat-bed sorting device. Figure 5-16 shows the same carts parked at right angles to a sloping-bed device. The sloping bed may accommodate two rows of bags to increase overall storage capacity. This can offset the reduction in perimeter frontage from that afforded with parallel parking. Although right-angle parking can reduce floor space by 30 to 50 percent, some carriers prefer parallel parking to minimize time and manpower for maneuvering and positioning of carts. In either case, the input conveyors need to be elevated to permit passage of carts and containers within the space.

(5) Semiautomated sorting utilizes mechanical equipment to move bags onto a lateral slide or conveyor designated for concurrently processing separate departures. Figure 5-17 shows a linear belt sorter capable of handling about 30 bags per minute, usually when the maximum number of departures processed concurrently does not exceed 12 to 15. The operator designates the appropriate lateral after reading the tag on each passing bag. A separate sorter is needed for each input conveyor line from the ATO.

(6) Tilt-tray sorters, as shown in Figure 5-18, are considered appropriate for very high volume stations requiring multiple inputs and greater capacities than possible with the preceding types. These systems are custom designed with relatively sophisticated coding and sorting features as well as lateral conveyors accumulating baggage for each departing flight. Terminal designs should allow the flexibility for future installation of such systems.

(7) Destination-coded vehicle systems (Figure 5-19) represent highly advanced technological proposals for handling the higher volumes, longer distances, interline transfers, and elevation changes encountered in terminals serving large hubs. Although the vehicles and propulsion methods vary, all have similar design criteria. These are: speeds up to 880 ft/min (268 m/min); elevation change capability (up to 33 degrees); fixed rights-of-way; programmable control systems and vehicle encoding; and interface with load/unload stations.

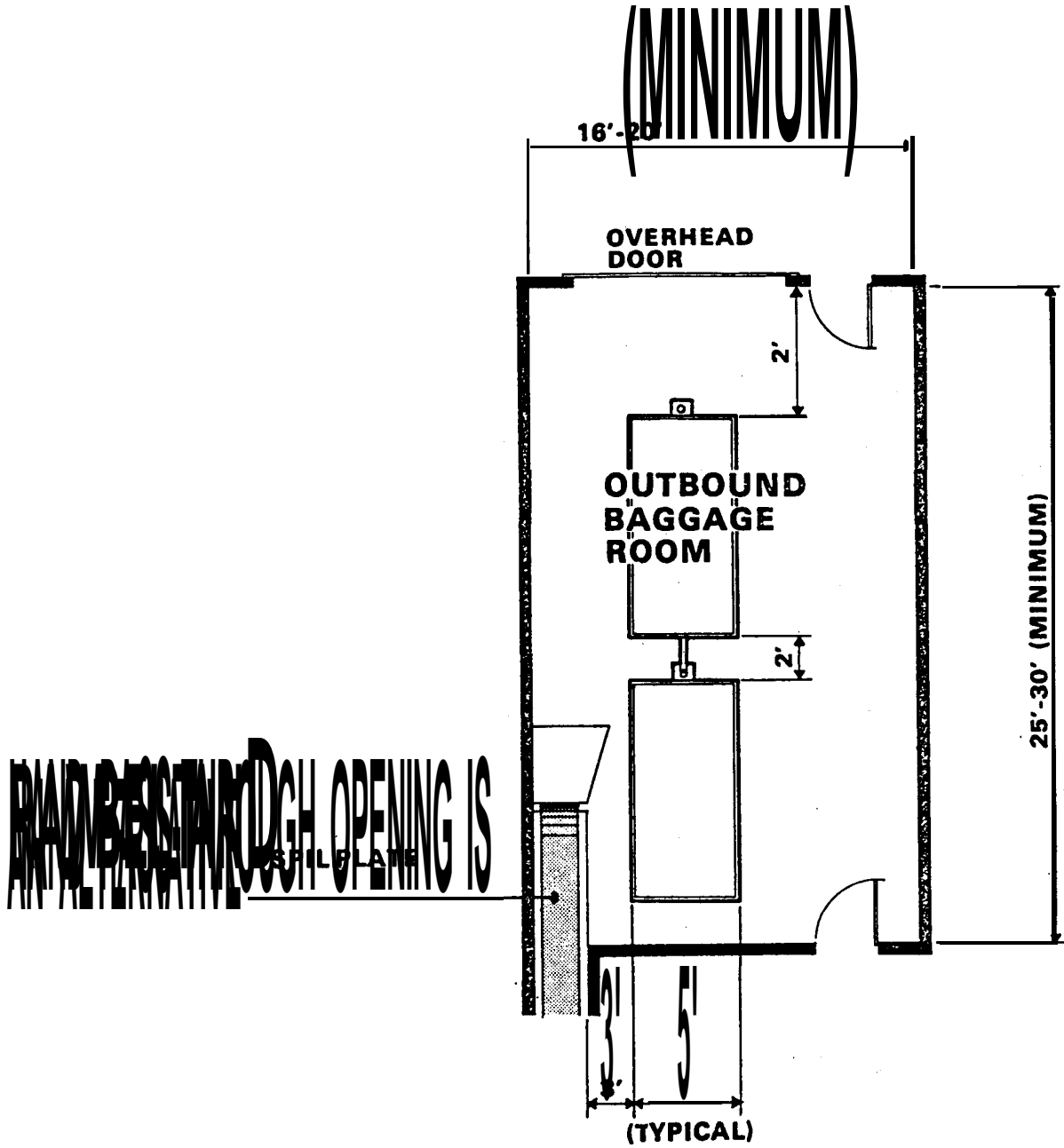

Figure 5-14. Outbound Baggage Room Typical Raw Belt Conveyor Installation

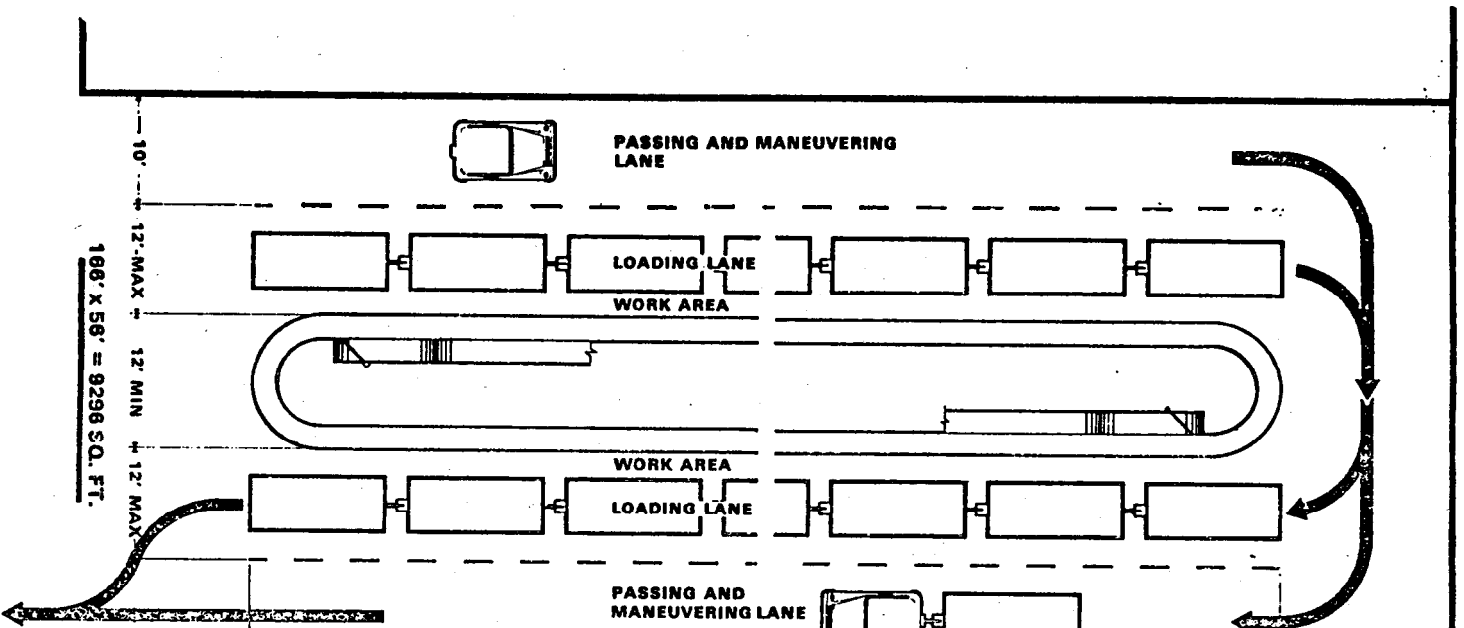

Figure 5-15. Outbound Baggage Recirculating Belt - Para

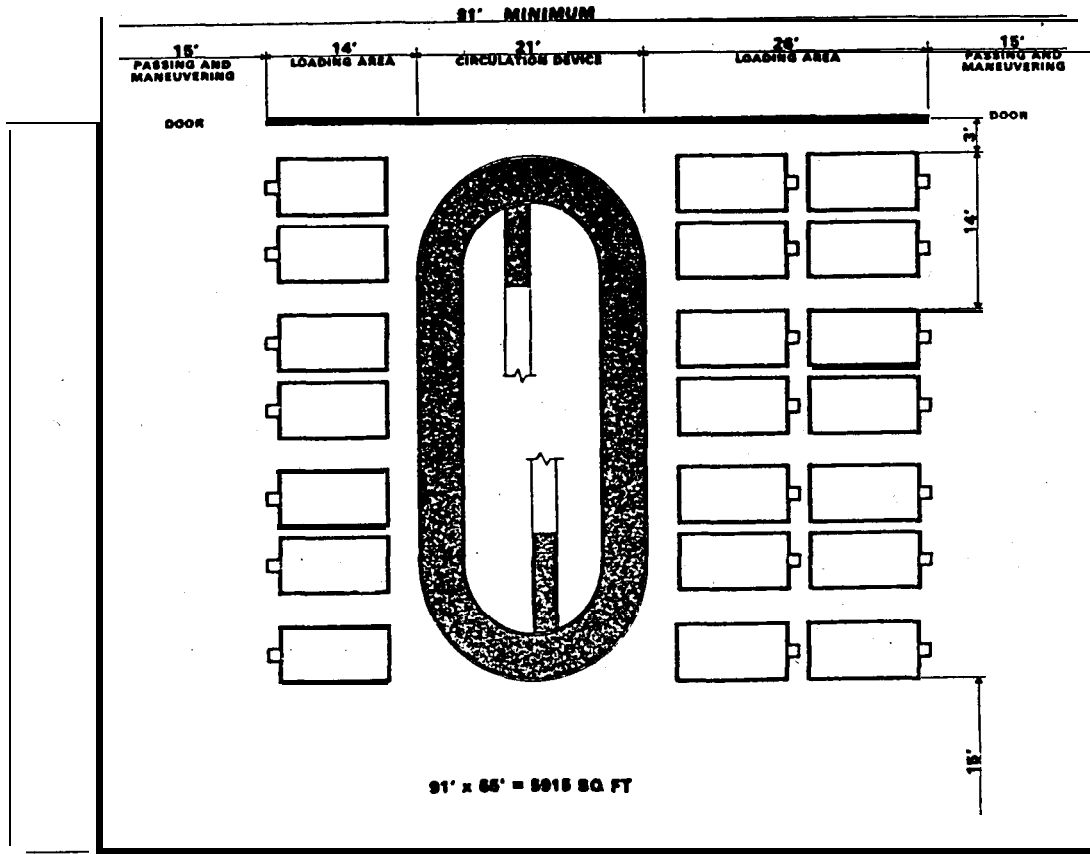

Figure 5-16. Outbound Baggage Recirculating Sloping Bed - Perpendicular Parking

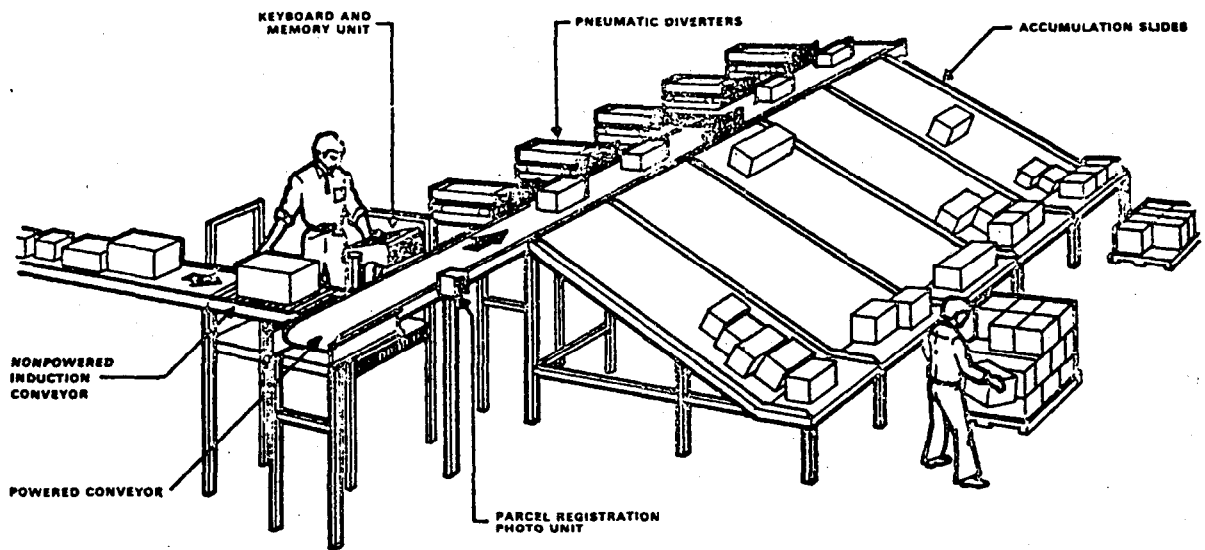

Figure 5-17. Semiautomated Linear Belt Sorter

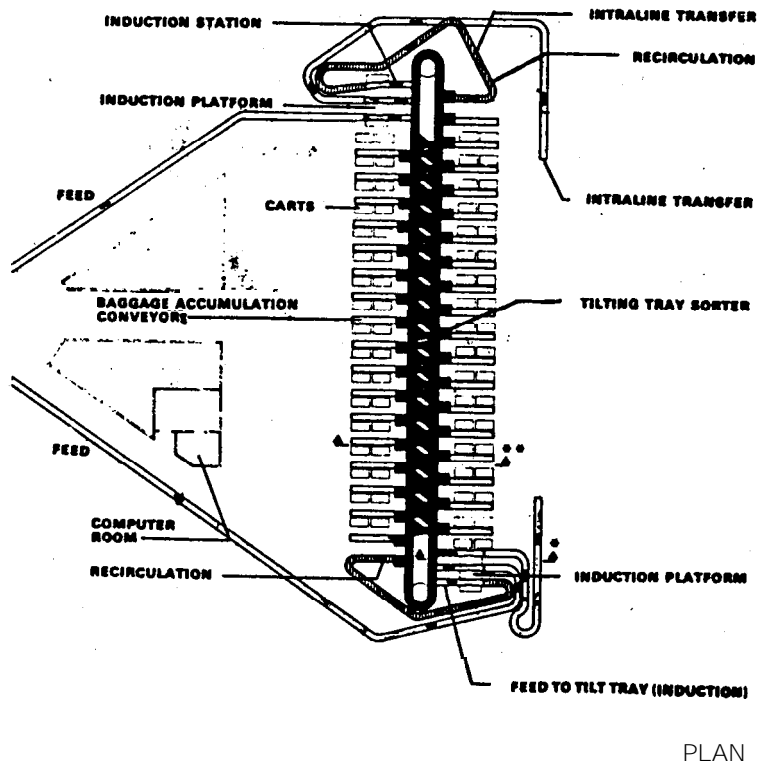
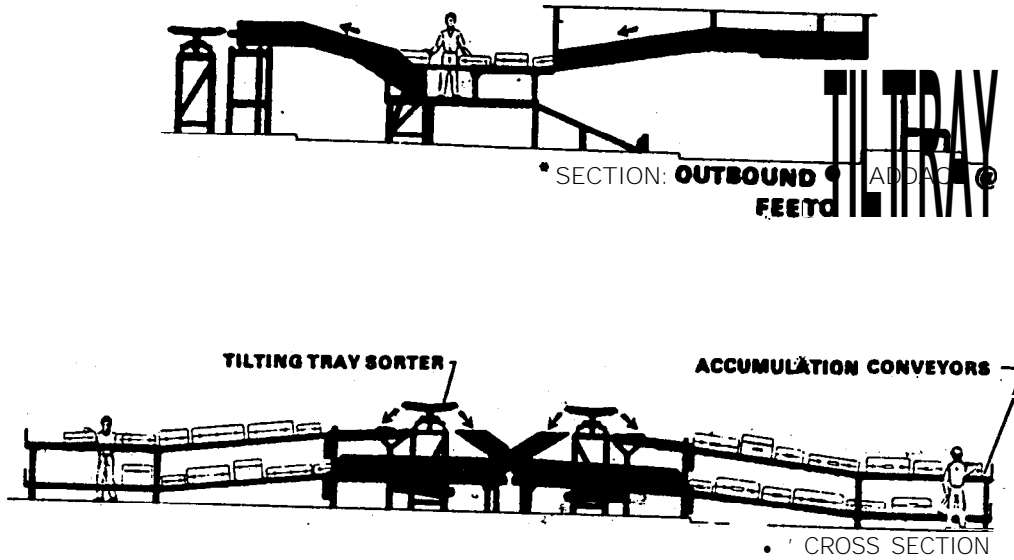

Figure 5-18. Tilt-Tray Sorter

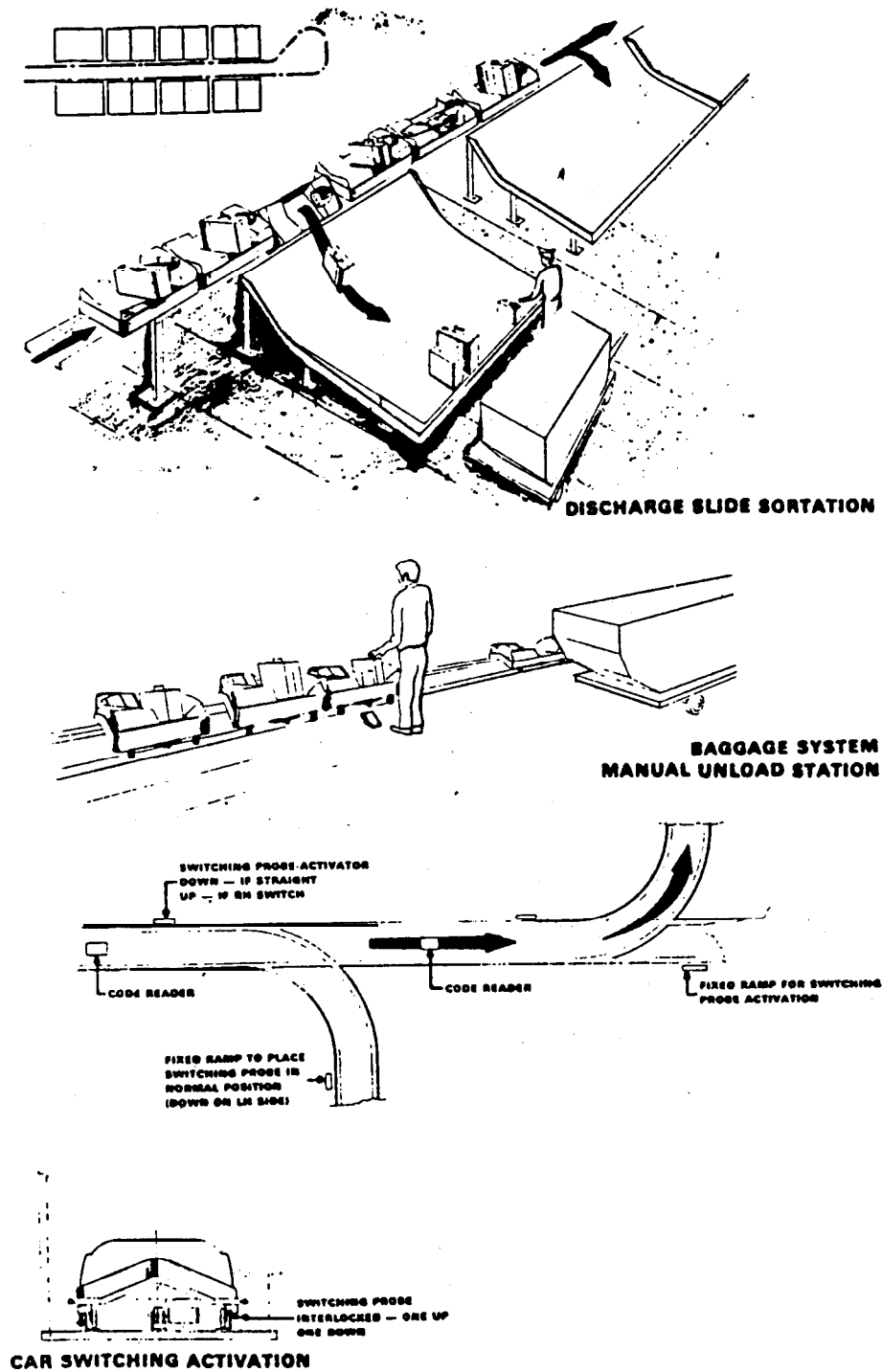

Figure 5-19. Destination-Coded Vehicle

g. Table 5-1 relates enplanement criteria and outbound baggage equipment.

Table 5-1. Recommended Selection Criteria Outbound Baggage Equipment

System type	Application Range Peak Hour Enplanements ¹ Average Day/Peak Month	Reference Figure No.
Manual (pass-through or raw belt with spill plate)	up to 200	5-14
Recirculation devices, accumulators, and indexing belts	150 to 1,500	5-15, 5-16
Linear belt sorter	300 to 800	5-17
Tilt-tray sorter	800 to 5,000+	5-18

¹ For one or more airlines sharing a single system.

h. Some noteworthy building design features in the outbound baggage area are provided below:

(1) Aisles at least **3 feet (1 m) wide** are usually required around **baggage** sorting device and between pairs of carts parked at right angles (unless carts only open on **one** side).

(2) Traffic lanes for cart **trains** normally require **10 feet (3 m)** with provisions for a 21 foot (6.5 m) outside radius at turns. Variations are such that airlines should be consulted.

(3) Vehicular door locations relative to the apron or restrictions in the number of such doors may necessitate additional space to manually maneuver carts or dollies.

(4) Column spacings are **particularly critical** and should be reviewed with airlines early in the planning stage.

(5) Minimum clear heights of 8 to 8.5 feet (2.4 to 2.6 m) are required by most airlines for containers on dollies for use **with** wide-body aircraft, although a 10 foot (3 m) clearance is often recommended.

(6) Since **airline** tugs/tractors have internal combustion engines, local code regulations and Federal standards for mechanical ventilation of enclosed areas should receive attention early in the **planning/design process**.

i. Trends in future outbound baggage handling systems include:

(1) **Computerized automated systems with hourly throughputs to 3,000 bags** per hour. Sorting error, other than human error, is expected to be reduced to 1 percent. Baggage is sorted by barcode tags read by a laser scanner.

(2) Large underground baggage handling facilities. These **facilities** will usually be located under aprons areas in order to provide the very large space needed by the baggage handling facility.

72. PUBLIC CORRIDORS.

a. Corridors are **provided** for public circulation between aircraft boarding gates and various lobbies and other areas within the terminal building. The effective corridor design width is **the total width less obstacles** (e.g., telephones, wastebaskets, benches, protruding displays, etc.) **with** a minimum clearance of approximately **2 feet (0.6 m)** on each side. This clearance is provided because of the **phenomenon known as** "boundary layer" in which a person will normally maintain **such** a clearance **between** corridor, walls and obstacles. **Viewing** areas for video displays and passenger queue areas extending into **the** corridor should also be **treated** as obstacles in **design width determinations**.

b. Figure 5-20 illustrates an effective corridor **design** width. **The design width** is determined by dividing the peak corridor population per minute (visitors and **passengers**) by the corridor width capacity factor expressed in people per unit width per minute. Table 5-2 **provides** a corridor capacity matrix based on an average walk rate of 242 feet (74 m) per minute. For example, the **bottom line** of Table 5-2 **indicates** a capacity of 330 to 494 persons

per minute for a corridor with a 20 foot (6 m) effective design width, for a pedestrian occupancy width of 2.5 feet (.76 m) and depth separation ranging from 4 to 6 feet (1.2 to 1.8 m). While a relatively abrupt introduction of deplaning passengers into a corridor may retard the walk rate, it will be offset somewhat by a decrease in their depth separation. A congregation of people awaiting the arrival of passengers may also retard the flow rate. This capacity reduction is usually only brief and local in nature and does not ultimately affect the overall corridor design capacity. This congestion can be minimized by providing areas for flow surge and greeters in the corridor width.

Table 5-2. Corridor Capacity in Persons Per Foot (.305 m) Width Per Minute

Width Occupancy Ft (m)	Depth Separation - Ft (m)				
	4.0 (1.20)	4.5 (1.35)	5.0 (1.50)	5.5 (1.65)	6.0 (1.80)
2.00 (.61)	30.9	27.5	24.7	22.5	20.6
2.25 (.69)	27.4	24.4	22.0	20.0	18.3
2.50 (.76)	24.7	22.0	19.8	18.0	16.5

73. SECURITY INSPECTION STATIONS.

a. Air carriers using over 60 passenger seat aircraft in scheduled or public charter operations are required by Federal Aviation Regulations (FAR) 121.538 to screen all passengers prior to boarding in accordance with the provisions of FAR Part 108. This activity is normally handled inside the terminal building at a security screening station.

b. There are three types of passenger inspection stations, depending on the location of the station in relation to the aircraft boarding area. These include:

- (1) Boarding Gate Station;
- (2) Holding Area Station; and
- (3) Sterile Concourse Station.

c. A sterile concourse station, from both the standpoint of passenger security facilitation and economics, is the most desirable type of screening station. It is generally located in a concourse or corridor leading to one or several pier finger(s) or satellite terminal(s) and permits the screening and control of all passengers and visitors passing beyond the screening location. It thus can control a considerable number of aircraft gates with a minimum amount of inspection equipment and personnel. Pier and satellite terminal concepts are well suited for application of the Sterile Concourse Station, since the single-point entrance connector element facilitates isolation of boarding areas.

d. Because of building geometry, especially that associated with linear and transporter terminal concepts, the Sterile Concourse Station is not always feasible. Under these circumstances, several inspection stations may be required to control a number of holding areas or departure lounges. In the worst situation, a screening station may be required at each boarding gate.

e. Except at low activity airports, where manual search procedures may be employed, a security inspection station will generally include a minimum of one walk-through weapons detector and one x-ray device. Such a station has a capacity of 500 to 600 persons per hour and requires an area ranging from 100 to 150 square feet (9 to 14 sq.m). Examples of security inspection station layouts are illustrated in Figure 5-21.

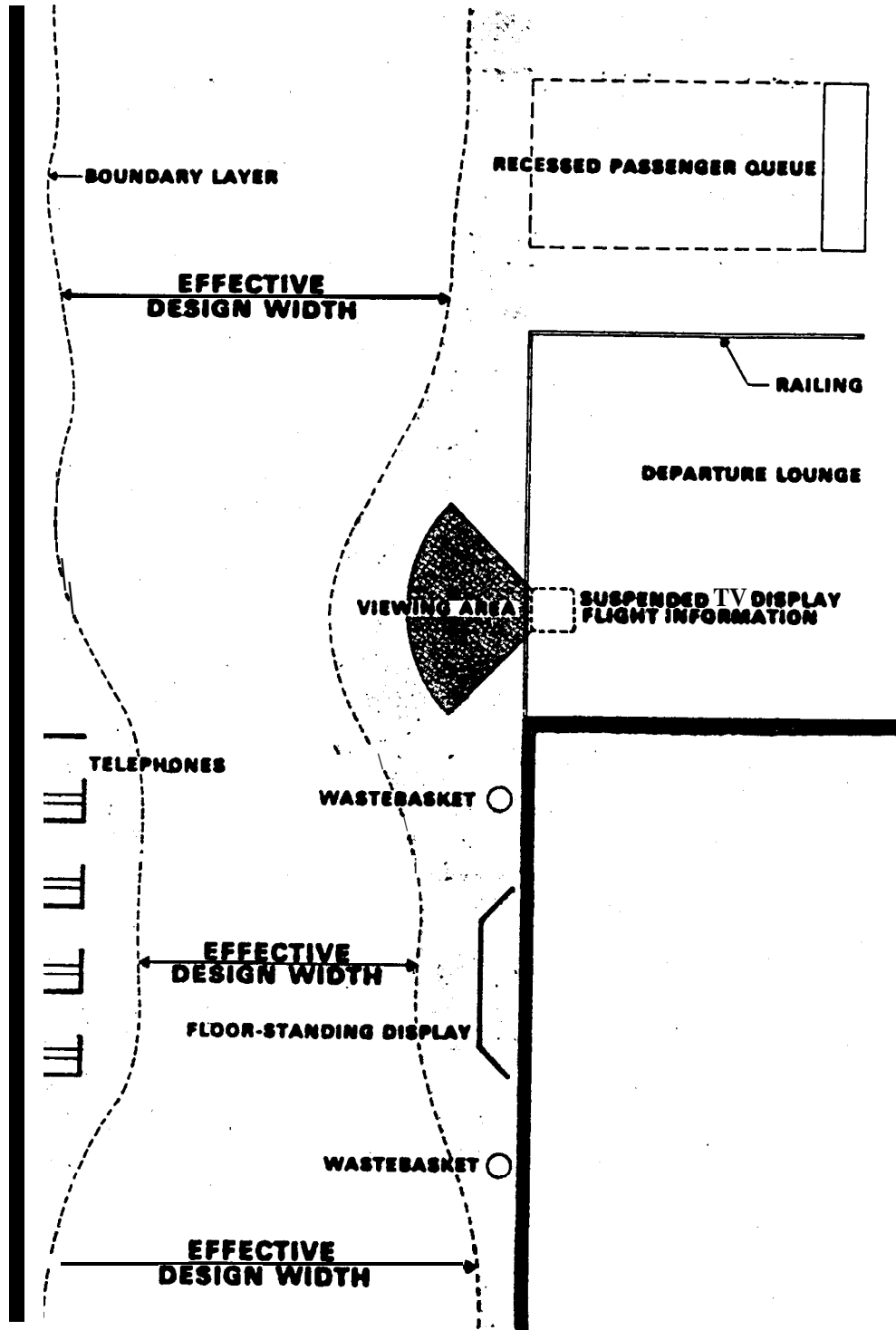
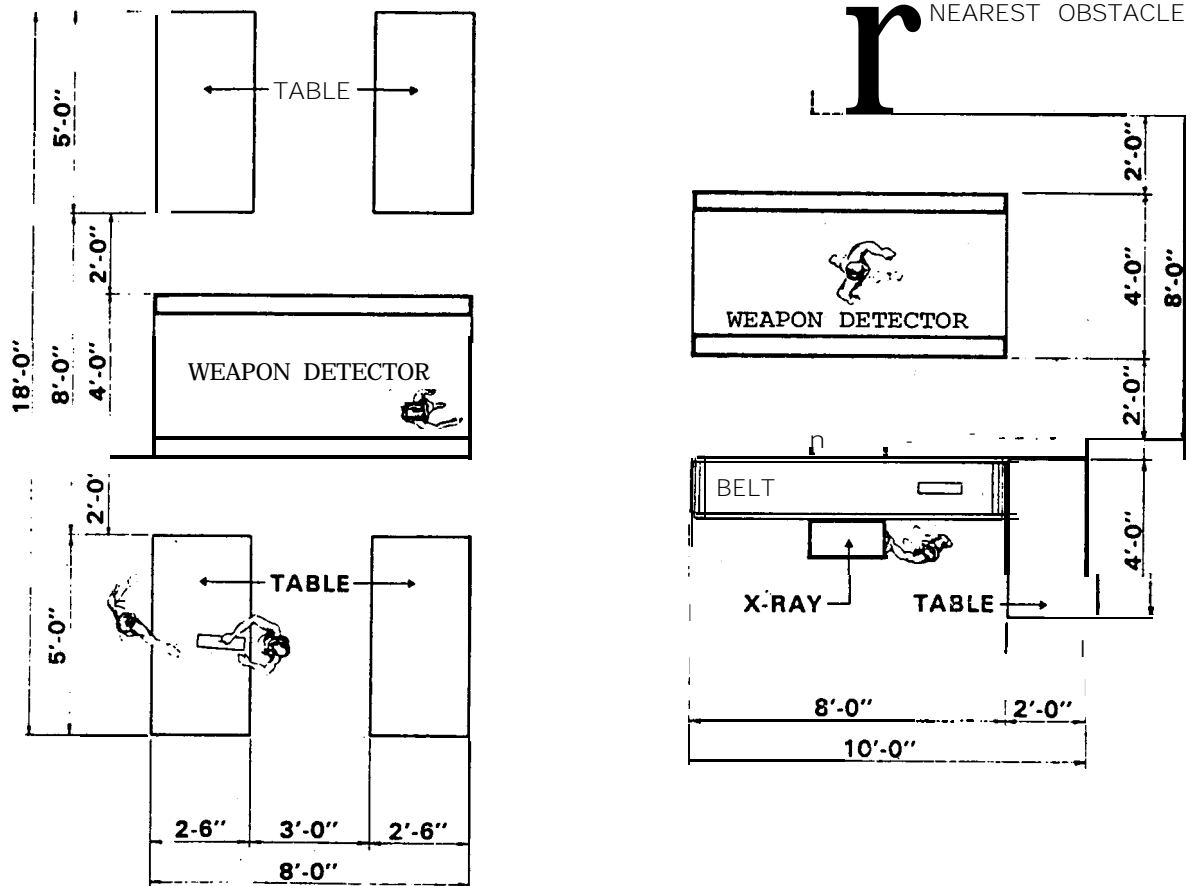

Figure S-20. Public Corridor Effective Desip Width



MANUAL SEARCH (144 SQ FT)

X-RAY SEARCH (120 SQ FT)

Figure 5-21. Security Inspection Station Layouts

f. Space leading to the security inspection station should allow room for queuing as the flow of passengers through security is often interrupted when a passenger requires a rescreening or physical search. Queuing space should not extend into or block other circulation elements.

g. The boarding area beyond a security screening checkpoint, whether a holding area concourse or departure lounge, requires a design which will enable security to be maintained. In this respect, the design and location of entrances, exits, fire doors, concessions, etc., require special consideration.

h. Other security considerations are discussed in Chapter 8.

74. DEPARTURE LOUNGES.

a. The departure lounge is the waiting or holding area for passengers immediately prior to boarding an aircraft. At most airports (excepting some low activity airports), departure lounges are normally included in the space leased and controlled by individual airlines.

b. The departure lounge normally includes: space for one or more airline agent positions for ticket collections, aircraft seat assignment, and baggage check-in; a seating and waiting area; a queuing area for aircraft boarding; and an aisle or separate corridor for aircraft deplaning. Figures 5-22, 5-23, 5-24, and 5-25 illustrate typical departure lounge layouts.

c. The number of agent positions/desks is determined by the user airlines on the basis of individual airline standards for passenger waiting, processing, and boarding procedures. A queue length of at least 10 feet (3 m) in front of agent positions should be provided in departure lounges at larger airports.

d. The departure lounge area is a function of the number of passengers anticipated to be in the lounge 15 minutes prior to aircraft boarding. Table 5-3 presents information for estimating departure lounge areas on the basis of aircraft seating capacity and load factors. The average depth of lounge area generally considered to be reasonable is 25 to 30 feet (8 to 9 m).

Table 5-3. Departure Lounge Area Space Requirements

Aircraft Seating Capacity	Departure Lounge Area Square Feet (Square Meters)		
	Boarding Load Factors		
	35-45 percent	55-65 percent	75-85 percent
Up to 80	350 (33)	515 (48)	675 (63)
81 to 110	600 (56)	850 (79)	1,110 (102)
111 to 160	850 (79)	1,175 (109)	1,500 (139)
161 to 220	1,200 (111)	1,600 (149)	2,000 (186)
221 to 280	1,500 (139)	2,000 (186)	2,500 (232)
281 to 420	2,200 (204)	3,000 (279)	3,800 (353)

e. When a lounge area serves more than one aircraft gate position, the estimated total lounge area shown in Table 5-3 may be reduced 5 percent for each aircraft gate position, up to a maximum of six gates.

f. Departure lounge seats are not generally provided to accommodate all passengers boarding an aircraft. A number of passengers will elect to remain standing in the waiting area while others will only arrive shortly before or during the boarding process. Between 15 and 20 square feet (1.4 to 1.9 m²), including aisle space, is required per seat.

g. The deplaning area is generally a roped aisle or separate corridor directly leading deplaning passengers from the loading bridge or apron gate to a public corridor. Separation from the rest of the departure lounge is provided to avoid interference and congestion between deplaning passengers and those waiting to board the aircraft. Six feet (2 m) is an acceptable width for this area.

75. BAGGAGE CLAIM FACILITIES.

a. Inbound baggage handling requires both public and nonpublic building areas. The public space (claiming area) is that in which passengers and visitors have access to checked baggage displayed for identification and claiming. Nonpublic space is used to off-load bags from carts and containers onto claim devices or conveyor systems for moving into the public area.

b. The claiming area should be located adjacent to a deplaning curb and have convenient access to ground transportation service and auto parking facilities. Passenger access from arriving flights should be direct and avoid conflicting with enplaning passengers. The claim area should also be readily accessible from the aircraft apron by means of carts, tractors, or mechanical conveyors for quick and direct baggage delivery.

c. At low activity airports, a simple claim shelf is the most common baggage claim scheme. As passenger activity increases, several types of mechanical claim devices, as illustrated in Figure 5-26, may be utilized to help reduce the overall required claim area length. A discussion of the more common claim schemes follows.

(1) **The simple shelf or counter** is merely a shelf or counter provided in a public area on which baggage from an arriving aircraft is placed for passenger identification and retrieval. Width of the shelf is generally 30 to 36 inches (75 to 90 cm). Passengers merely move laterally along the shelf until their baggage is located and claimed.

(2) **Flat-bed plate devices** are particularly applicable when direct feed loading areas are immediately adjacent and parallel to the claiming area and on the same floor level.

(3) **Sloping-bed devices** are somewhat more adaptable for remote feed situations where the loading area cannot be immediately adjacent to the claiming area or must be located on a different floor level. In some cases, the width of the sloping bed is sufficient to provide storage of two rows of bags.

d. At low volume airports, exclusive-use facilities are not usually economically justified and claim facilities are shared or assigned preferentially to several airlines. The use of a Design Day Activity Analysis (see paragraph 24) is recommended to size baggage claim facilities. In this analysis, passenger arrivals in periods of peak 20 minutes are used as the basis for sizing. However, when exclusive facilities are planned, each airline determines its baggage claim frontage and space requirements according to its own criteria for sizing space, systems, and staffing.

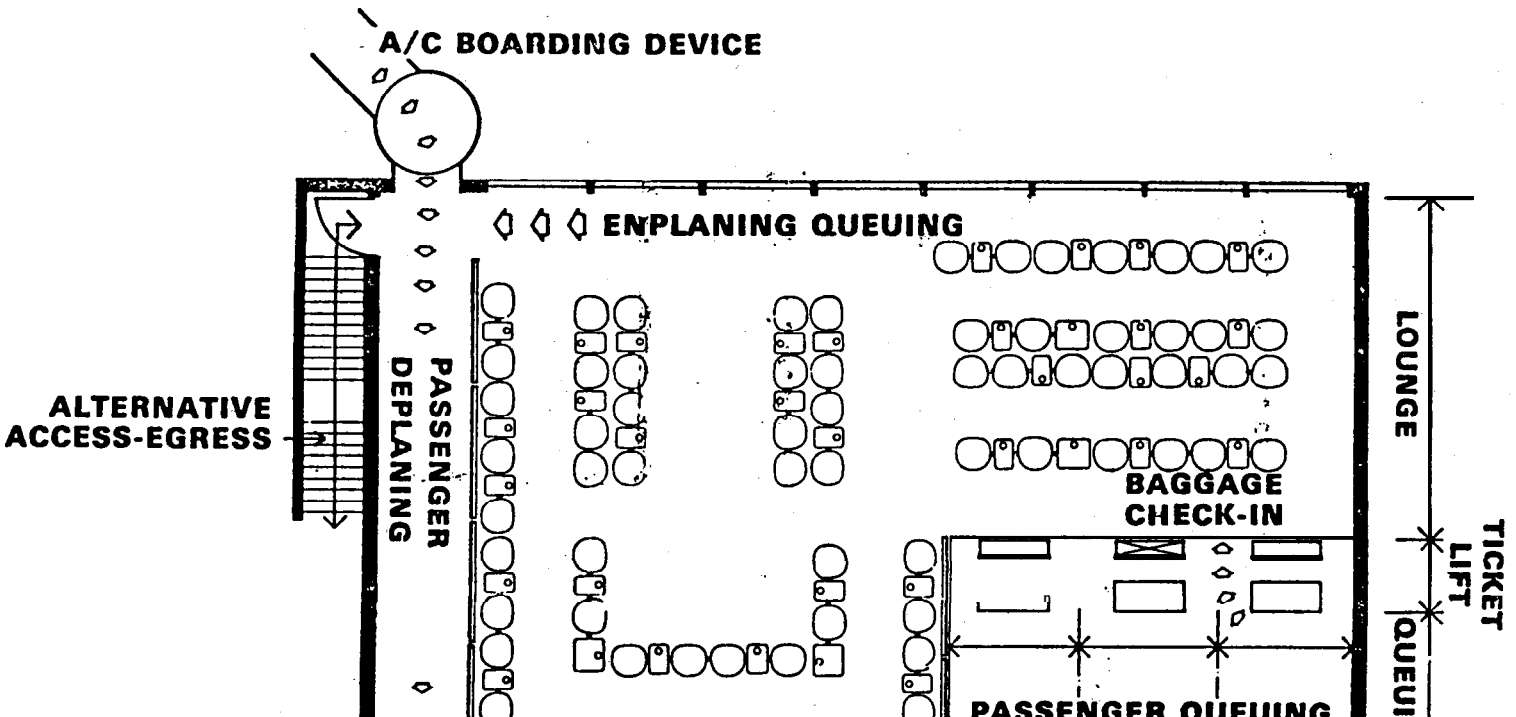

Figure 5-22. Typical Departure Lounge Layout.

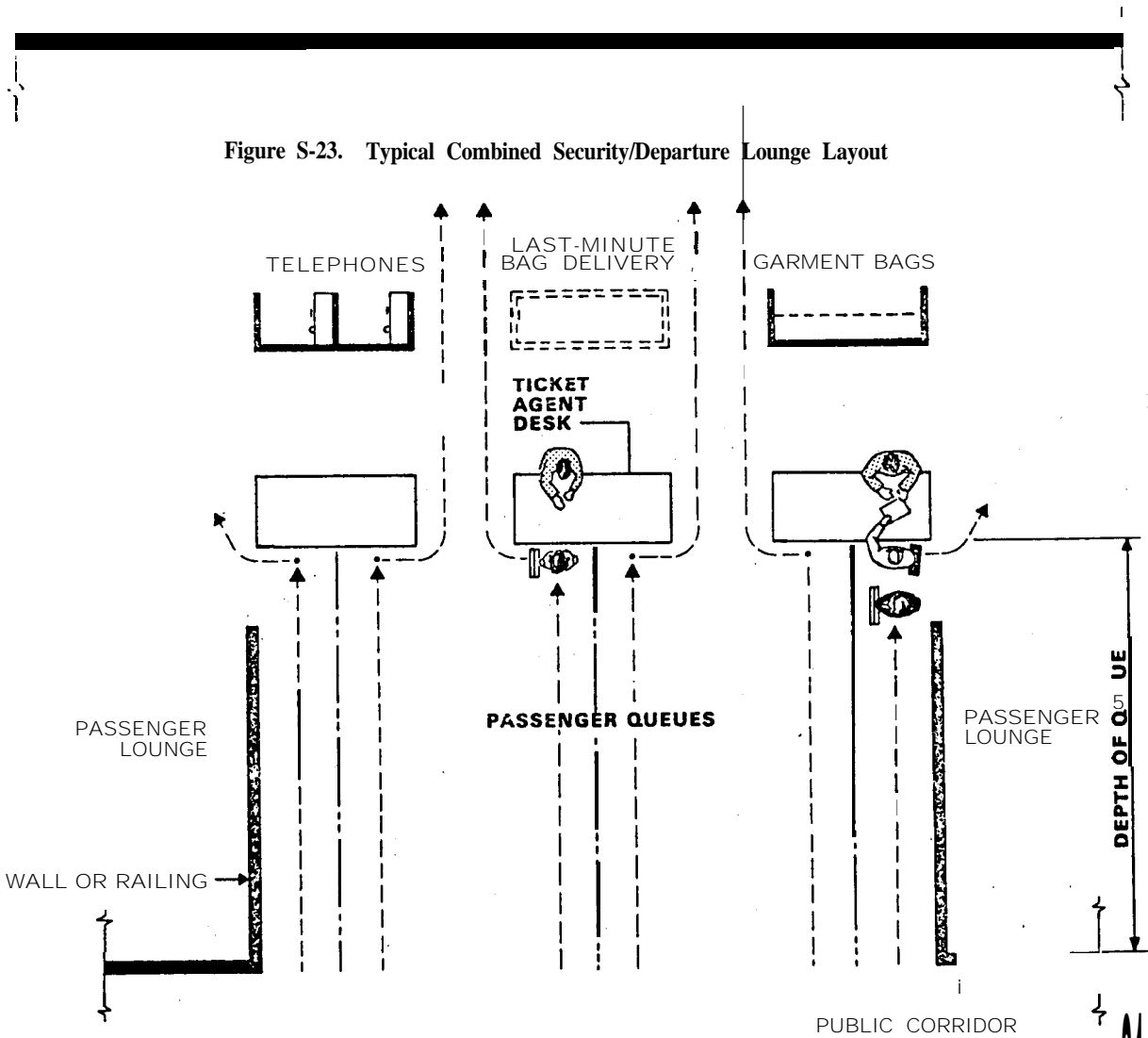
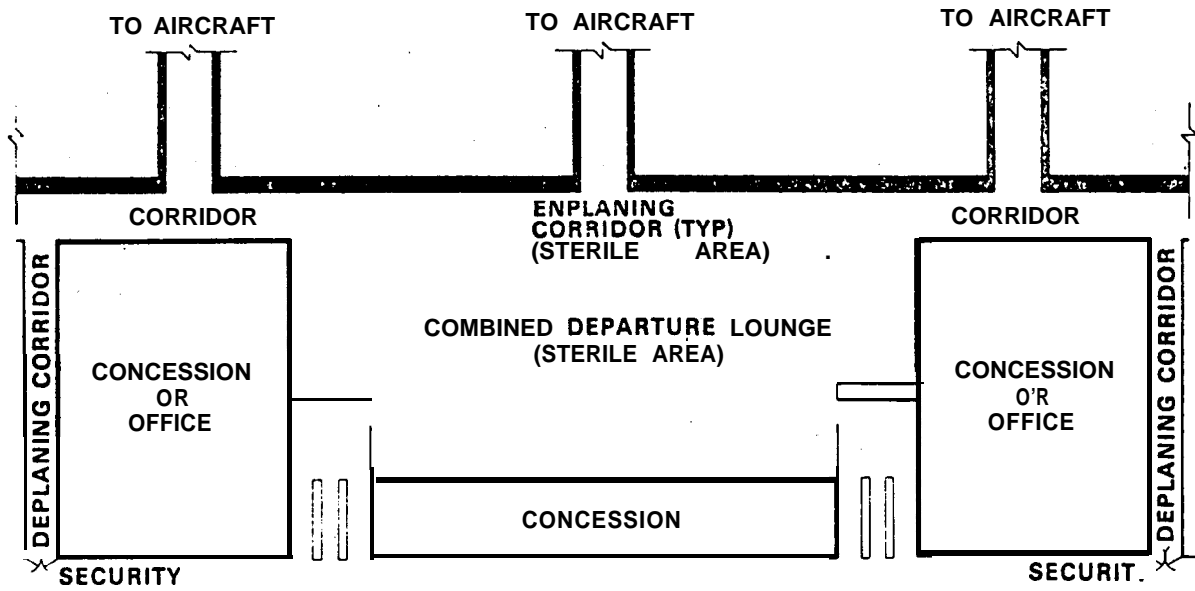
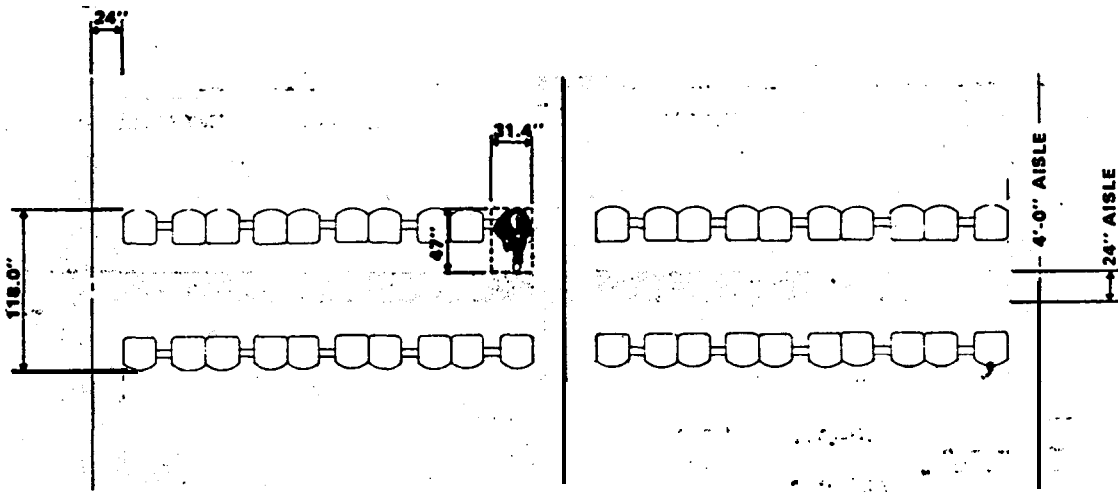

Figure S-24. Departure Lounge Passenger Processing Area



AREA/PASSENGER = 12.87 SQ. FT

AREA/AISLE = $\frac{48 \text{ IN.} \times 118 \text{ IN.}}{124 \text{ SQ. IN.} \times 20} = 1.97 \text{ SQ. FT}$

TOTAL AREA/SEATED PASSENGER = $(118 \text{ IN.} \times 10 \text{ PAIRS}) + (48 \text{ IN.} \times 118 \text{ IN.}) = 14.83 \text{ SQ. FT.}$

114 SQ. IN. a 20 88elom8 = 15 SQ. FT./PASS.

***ONE UNIT LENGTH OF AISLE
4'-0" WIDE WILL SERVE
20 SEATED PASSENGERS**

Figure 5-25. Departure Lounge Typical Seating/Aisle Layout

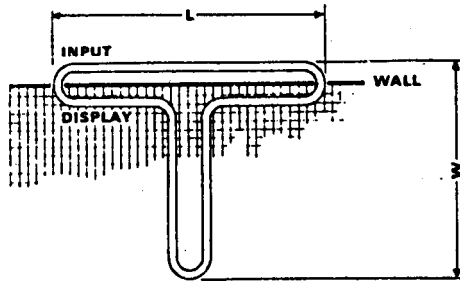

FLATBED — 'DIRECT FEED

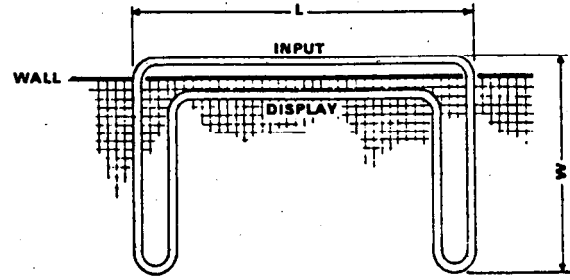

FLATBED — DIRECT FEED

SHAPE	L&W (FT)	CLAIM FRONTAGE (FT)	BAG STORAGE*
○	65 x 5	65	78
▭	85 x 45	180	216
▭	85 x 65	220	264
▭	50 x 45	190	228

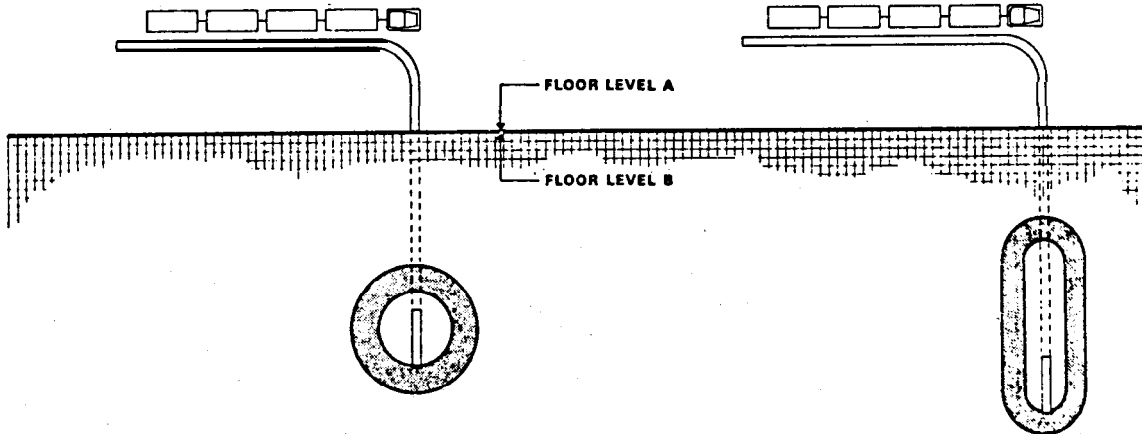

CIRCULAR
REMOTE FEED SLOPING BED

○
REMOTE FEED SLOPING BED

DIAMETER (FT)	CLAIM FRONTAGE (FT)	BAG STORAGE*
20	63	94
26	78	132
30	94	169

L&W (FT)	CLAIM FRONTAGE (FT)	BAG STORAGE*
36 x 20	95	170
52 x 20	128	247
68 x 18	166	318

• THEORETICAL BAGSTORAGE— PRACTICAL BAG STORAGE CAPABILITY IS 1/3 LESS

Figure S-26. Mechanized Claim Devices



e. A public claiming area may require railings or similar separation from other public space and controlled egress to enable inspection of removed baggage for assurance of "positive claim." At some terminals, additional space may be needed adjacent to the claiming area for storage and security of unclaimed baggage and for airline baggage service facilities (lost and found).

f. For planning purposes, claim display frontage can be estimated by the use of either Figure 5-27 or 5-28. These nomographs utilize "Equivalent Aircraft Arrivals" (see paragraph 28) to approximate deplaning passengers in a 20 minute peak period, assuming an average of 1.3 bags per deplaning passenger. The claiming frontage requirements may be converted to baggage claim facility area requirements by, using Figure 5-29. The value presented includes: space for public circulation; area normally required within a controlled "positive-claim*" facility; and space for airline baggage service facilities. It should be recognized that considerable variance in space requirements occurs between airports due to airline company policies and the number of airlines using a claim area.

g. Figure 5-30 can be used to approximate the nonpublic space required to input and load bags onto claim devices. The figure assumes a 22 foot (7 m) depth, 20 feet 6 m) for the fixed shelf, behind the input section or belt for offloading carts and for passing/maneuvering. At many airports in mild climates, the non-public baggage input area may be satisfied without complete enclosure in the terminal building through use of overhead canopies. This can also apply to the public baggage claim area at some low volume airports.

h. The area approximations developed from Figures 5-29 and 5-30 assume a relatively efficient use of building space. At existing terminals being modified to accept a claim device installation, additional space per foot of claim display may be required because prior column locations limit the efficient area use.

i. The baggage claim lobby area for public circulation and passenger amenities and services is discussed in paragraph 69c.

76. AIRLINE OPERATIONS AREAS.

a. Airline operations areas are those areas occupied by airline personnel for performing the functions related to aircraft handling at the gate. Composition of functions will vary among individual airports. The following areas are most commonly required:

(1) **Cabin Service or Commissary** - an area for the storage of immediate need items for providing service to the aircraft cabin.

(2) **Cabin Service and Ramp Service Personnel** - an area for training facilities and a ready/lunch room.

(3) **Aircraft Line Maintenance** - for supplies, tools, storage, personnel, etc.

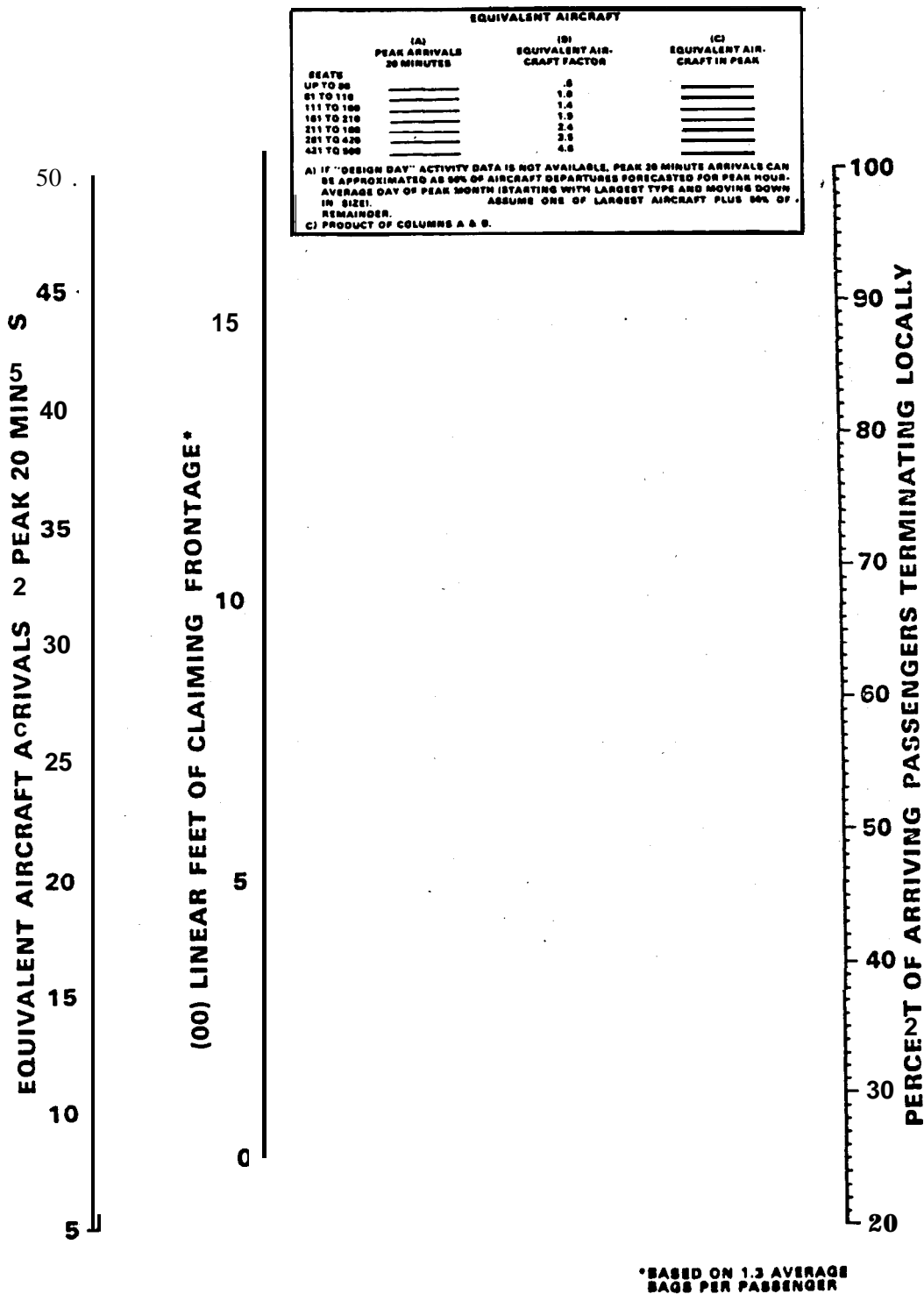

Figure 5-27. Inbound Baggage Claim Frontage - Less than Five EQA Arrivals in Peak 20 Minutes

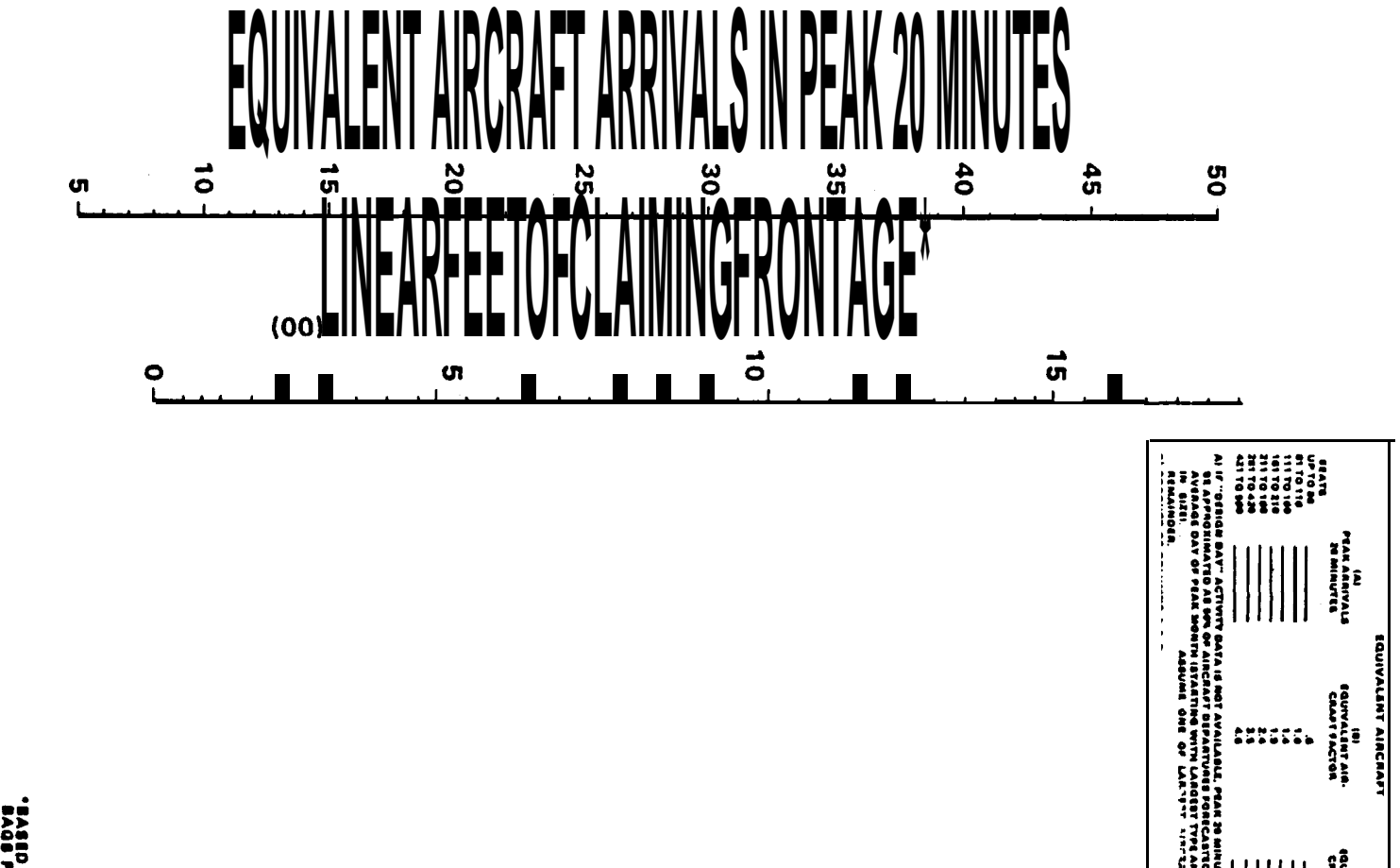
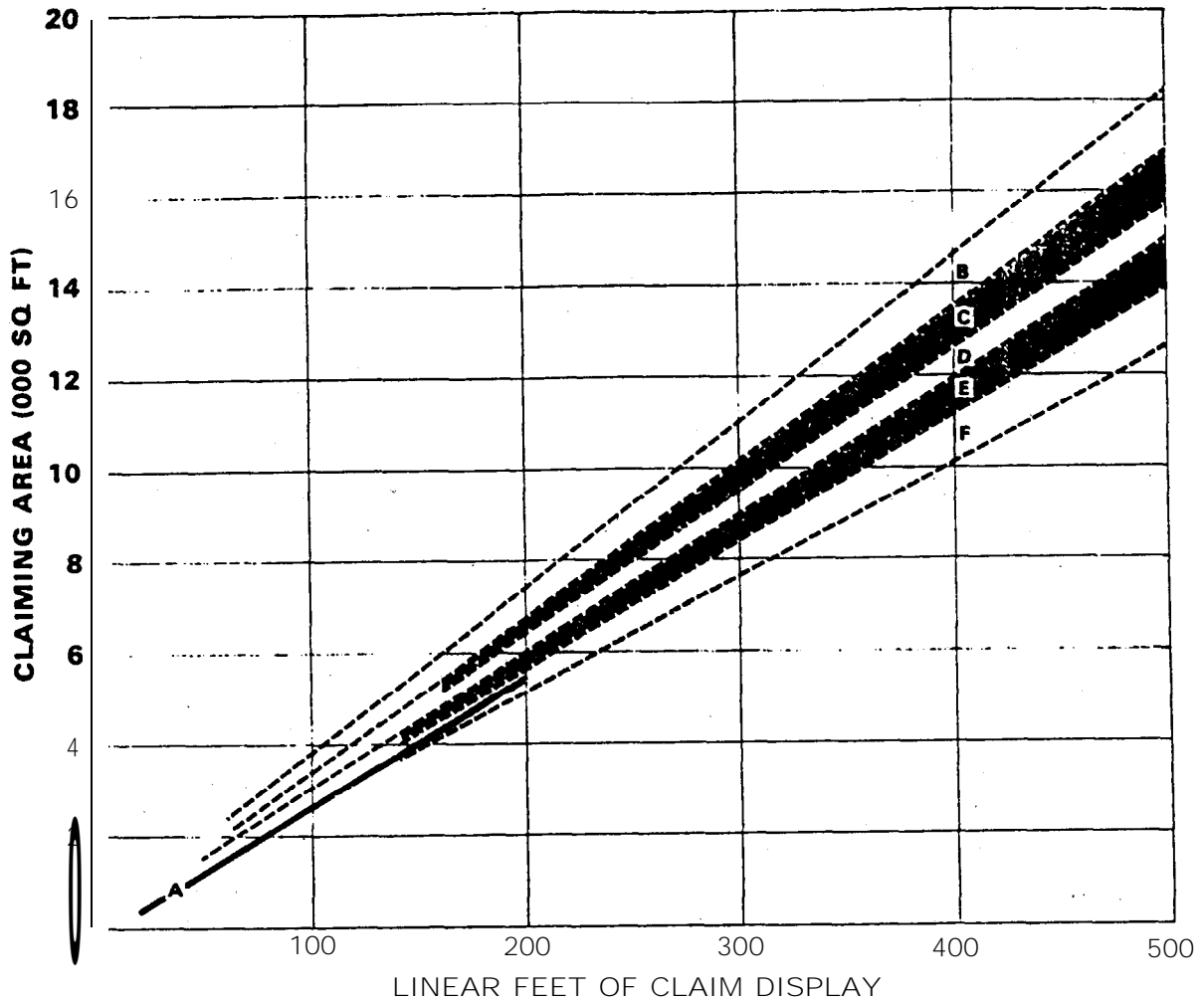

Figure 5-28. Inbound Baggage Claim Frontage - Five or More EQA Arrivals



AREAS FOR OPTIMUM CONFIGURATIONS OF:

- A FIXED SHELF
- B** **ROUND** — SLOPING BED/REMOTE FEED
TEE — FLAT BED/DIRECT FEED
- C** TEE AND U-SHAPE ALTERNATING @ 75'
(FLAT BED/DIRECT FEED)
- D** **OVAL** — FLAT BED/DIRECT FEED
OVAL — SLOPING BED/REMOTE FEED
- E** TEE-AND U-SHAPE ALTERNATING @ 60'
(FLAT BED/DIRECT FEED)
- F** **U**-SHAPE **FLAT** BED/DIRECT FEED

* INCLUDES INPUT SECTION
OF FLAT BED DEVICES

NOTE: FIND DISPLAY LENGTH FROM FIGURES 5-27 OR 5-28.
THEN SELECT DEVICE AND READ RANGE OF REQUIRED AREA.

Figure 5-29. Baggage Claim Area

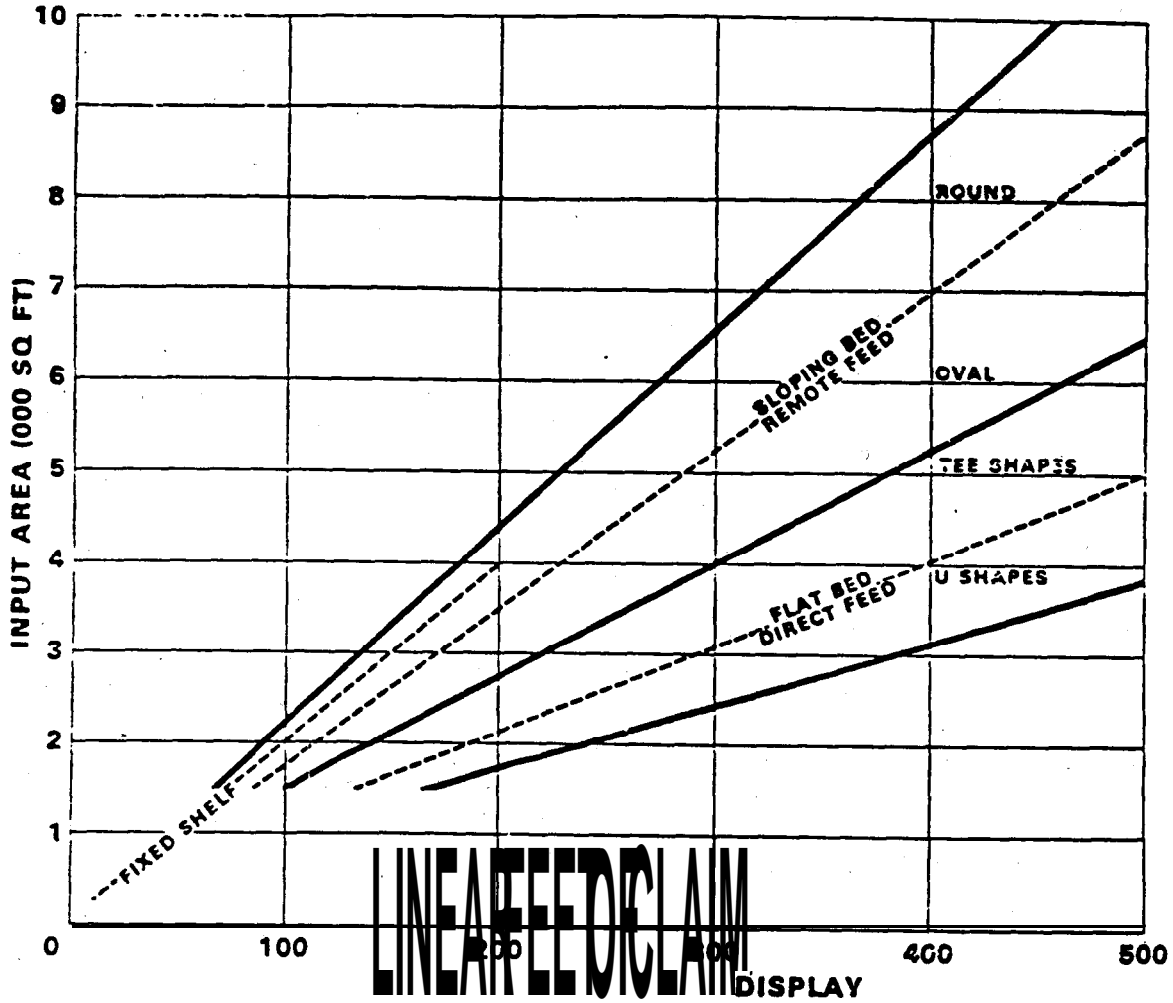

NOTES: WERE INTERIOR JOINT-USE DRIVES ARE REQUIRED, INCREASE OUTPUT AREA BY 35%.
FIND DISPLAY LENGTH FROM FIGURES 5-27 OR 5-28. THEN SELECT DEVICE AND READ RANGE OF REQUIRED AREA.

Figure 5-30. Non-Public Baggage Claim Input Area

- (4) **Office Area** – for managerial personnel and clerks.
- (5) **Flight Operations Facilities** – includes a message center, area for meteorological data and flight plans, and flight operations personnel.
- (6) **Flight Crew and Flight Attendant Facilities** – includes an area for resting, toilet facilities, and personal grooming area.
- (7) **Secure Area Storage** – for items requiring secure storage because of either the value or fragility of the items.
- (8) **Volatile Storage** – for items requiring extra precautionary storage due to instability in handling and storage.

b. Storage and administrative areas often can and are combined. Depending on flight schedules, flight crew and flight attendant facilities may not be required or can be combined with facilities for other airline personnel. Similarly, facilities for flight operations and administrative personnel can be combined.

c. The area required for airline operations may be estimated for planning purposes on the basis of 500 square feet (46.5 m²) per equivalent peak hour aircraft departure. This factor includes all of the operations areas previously described. However, at some airports one or more airlines may use additional terminal space for regional or airline system functions and/or other support services beyond those functions common to daily airport operations.

77. FOOD AND BEVERAGE SERVICES.

a. These services include snack bars, coffee shops, restaurants, and bar lounges. The basic service offered at small airports is the coffee shop, although separate restaurants at some smaller city airports can be **successful**, depending on the community and restaurant management. Large airports usually can justify several locations for snack bars, coffee shops, bar lounges, and restaurants. Requirements for more than one of each type are highly influenced by the airport size and terminal concept involved. Unit terminals, for instance, may require coffee shops and/or snack bars at each separate terminal.

b. Generally speaking, a coffee shop seating less than 80 is considered an uneconomical operation at airports enplaning over one million passengers annually. At smaller airports, the seating capacity minimum may be somewhat lower, depending on such factors as local labor costs and concessionaire lease arrangements.

c. The following ranges appear representative for food and beverage services:

(1) Turnover rates: 10 to 19 average daily per seat. **Some** operators appear satisfied averaging 10 to 14 daily.

(2) Space per seat: 35 to 40 square feet (3.3 to 3.7 m²) per coffee shop/restaurant seat, including support space.

(3) Snack bars: 15 to 25 percent of coffee shop/restaurant overall space requirements.

(4) Bar lounges: 25 to 35 percent of coffee shop/restaurant overall space requirements.

d. The sizing of food and beverage services involves applying “use factors.” Use factors are determined by dividing the average daily transactions by average daily enplanements. Figure 5-31 shows ranges of food and beverage service areas for coffee shop and restaurants, snack bar, bar lounge and kitchen support space for various “use factors.”

e. For estimating and for initial planning purposes, the following average daily use factors are suggested:

(1) 40 to 60 percent at terminal airports with a high percentage of long-haul flights;

(2) 20 to 40 percent at transfer airports and through airports; and,

(3) 15 to 25 percent at terminal airports with a low percentage of long-haul flights.

78. CONCESSIONAIRE AND BUILDING SERVICES. The following building and concessionaire services are provided at airport terminals as appropriate for the size and activity of the airport. General area ranges for many of these services are presented for planning purposes. Larger areas may be required. Figure 5-32 provides a nomograph for approximating total area requirements for those services discussed in subparagraphs a. through s. The requirements presented in paragraphs t. through v. are determined separately on a case-by-case basis.

a. News and tobacco are physically separate at most airports where annual enplanements exceed **200,000** per year, and may be combined with other services at airports with lesser traffic. Space allowance: 150 square feet minimum, and averaging 600 to 700 square feet (**56 to 66 m²**) per million annual enplanements.

b. Gift and apparel shops operations are combined with a newsstand at smaller airports. Separate facilities normally become feasible when annual enplanements exceed one million. Space allowance: 600 to 700 square feet (**56 to 66 m²**) per million annual enplanements.

c. Drug store, including sale of books, cards, and liquor, may be feasible as separate operation when annual enplanements exceed 1.5 million. Space allowance: 700 square feet (**66 m²**) minimum and averaging 600 to 700 square feet (**56 to 66 m²**) per million enplanements.

d. Barber and shoe shine operations at some large airports allow one chair per million annual enplanements. The most successful operations range from three to seven chairs. Space allowance: 110 to 120 square feet (**10.2 to 11.2 m²**) per chair with 150 square feet (**14 m²**) for a minimum facility.

e. Auto rental counters vary according to the number of companies. Space allowance: 350 to 400 square feet (**33 to 37 m²**) per million annual enplanements.

f. Florist shop operation as a separate function may become feasible when annual enplanements exceed 2 million. The usual space allowed is 350 to 400 square feet (**31.5 to 32 m²**) per terminal.

g. Displays (including courtesy phones for hotels). Space allowance: 90 to 100 square feet (**8.4 to 9.3 m²**) per million annual enplanements.

h. Insurance (including counters and machines). Space allowance: 150 to 175 square feet (**14 to 16 m²**) per million annual enplanements.

i. Public lockers require in the range of 70 to 80 square feet (**6.5 to 7.4 m²**) per million annual enplanements.

j. Public telephones space requirement is 100 to 110 square feet (**9.3 to 10.2 m²**) per million annual enplanements.

k. Automated post offices may be found desirable to the extent of providing one station, 125 square feet (**11.6 m²**) for each terminal serving at least 2.75 million annual enplanements.

l. Vending machine items supplement staffed facilities, especially when extended hours of operation are not justified by low volumes or multiplicity of locations. When vending machines are provided, they should be grouped and/or recessed to avoid encroaching upon circulation space for primary traffic flows. Space allowance: 50 square feet (**4.7 m²**) minimum or 150 square feet (**14 m²**) per million annual enplanements.

m. Public toilets are sized for building occupancy in accordance with local codes. Space allowances applied at airports vary greatly. They range from 1,500 to 1,800 square feet (**140 to 167 m²**) per 500 **peak-**hour passengers (in and out) down to 1,333 square feet (**124 m²**) per million annual enplanements at large hub airports.

n. Airport management offices' space requirements vary greatly according to the size of staff and the extent to which airport authority headquarters are located in the terminal. Accordingly, Figure 5-32 excludes space requirements for airport authorities and includes only such **space** as is representative of an airport manager and staff.

o. Airport Police/Security Office space needs vary according to based staff and nature of arrangements with local community law enforcement agencies.

p. Medical aid facilities' space requirements range from that needed for first-aid service provided by airport police to that for branch operations at off-airport clinics.

q. **USO/Travelers Aid** facilities vary considerably. Space requirements are relatively minor, 80 to 100 square feet (7.4 to 9.3 m²), except at airports with annual enplanements of over one million.

r. **Nursery** facilities for travelers with small infants have been provided at airports with annual enplanements of over 1 million. The most practical solutions include a private toilet room of 50 to 60 square feet (4.7 to 5.6 m²) with facilities for changing and feeding. The number of such facilities may range from two up, depending upon terminal size and configuration.

s. **Building maintenance and storage** varies, depending upon the types of maintenance (contracted versus authority operated) and storage facilities available in other authority-owned buildings.

t. **Building mechanical systems (HVAC)** space ranges from 12 to 15 percent of the gross total space approximated for all other terminal functions. A value of 10 to 12 percent is used in relation to the connector element space. This allowance does not cover separate facilities for primary source heating and refrigeration (H&R plants).

u. **Building structure** space allowance for columns and walls is 5 percent of the total gross area approximated for all other functions.

v. **Other** space, as determined on a case-by-case basis, may be required at some airports for information services, government offices, contract service facilities and the like.

79. - 90. RESERVED.

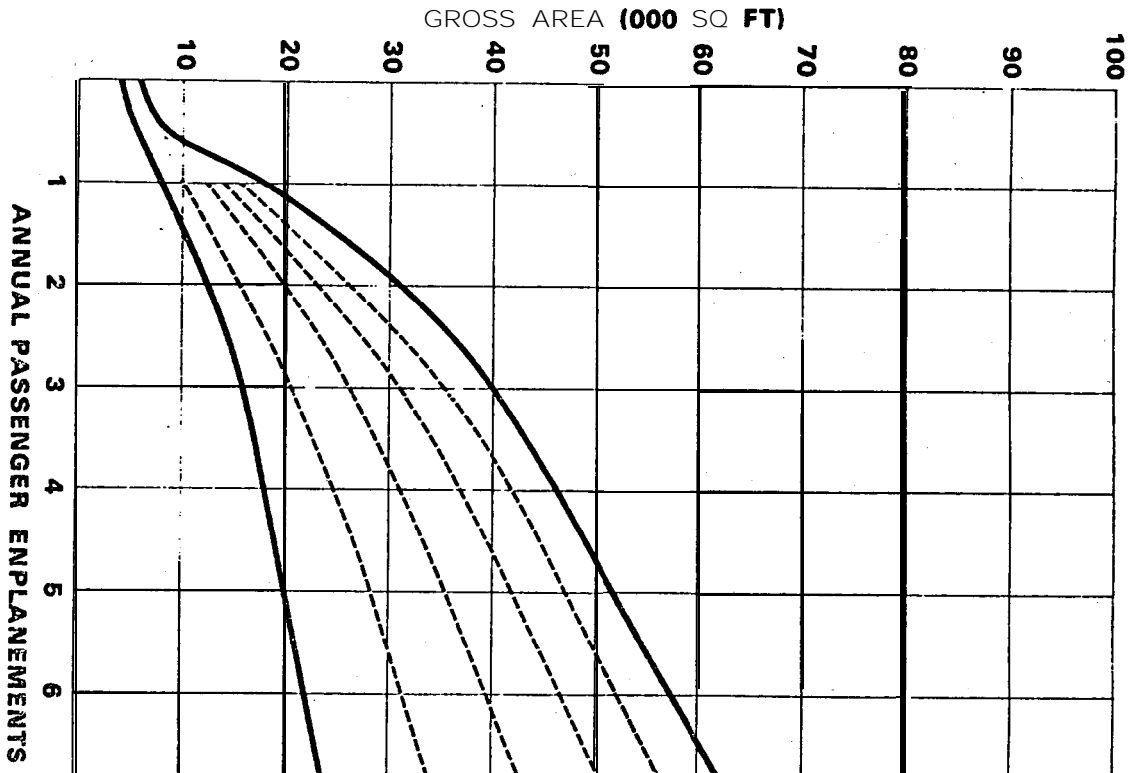

Figure S-31. Food and Beverage Services

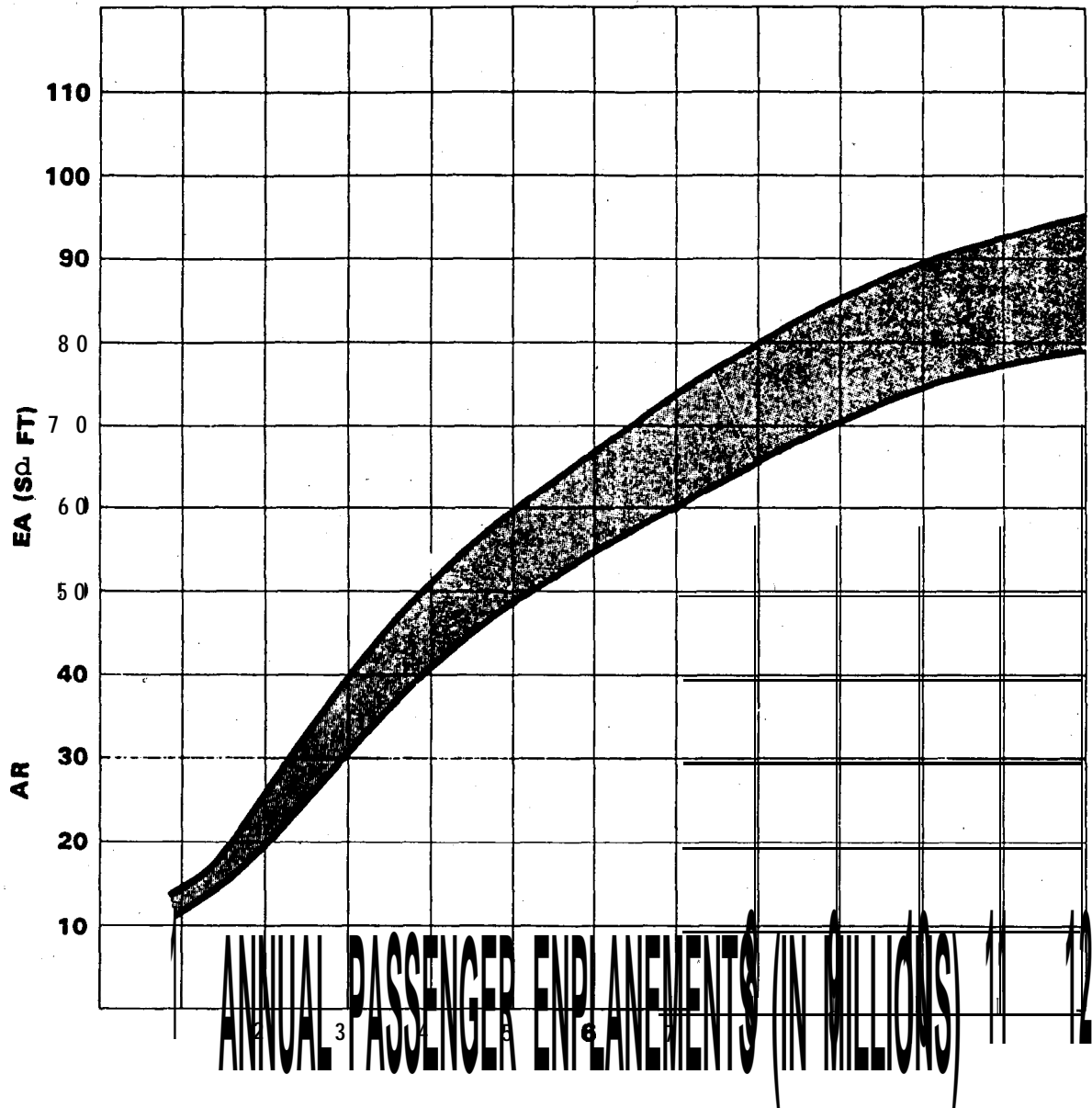

Figure 5-32. Concessions and building Services

CHAPTER 6. FEDERAL INSPECTION SERVICES (FIS) FACILITIES

91. **GENERAL.** Airports with international traffic require space for Federal inspections (Immigration, Customs, Agriculture, and Public Health Service) of passengers, aircraft, crew members, baggage, and cargo. The area required for these procedures is designated as the Federal Inspection Services (FIS) facility. This facility is generally located either in the main terminal building, within the terminal connector element, or in a separate international arrival building. The U.S. Customs Service publishes a document entitled "Airports--U.S.A. and Preclearance Facilities-- Guidelines for Federal Inspection Services," which contains guidance on space and facility requirements for FIS facilities. This chapter summarizes the more important aspects and material contained in that document. In using these guidelines, it should be recognized that variations in local conditions may require special facility considerations at one airport, but not at another. Consultation with FIS and airline representatives in the early stages of terminal design is necessary to assure meeting all FIS requirements.

92. **FEDERAL INSPECTION SERVICES.** Governmental procedures applicable to the clearance of passengers, baggage, and cargo arriving at designated international airports are the outgrowth of legislation, law, administrative regulations, bilateral treaties and experience. The following paragraphs describe the statutes establishing applicable inspection requirements and the Federal services designated to administer them.

a. **Immigration and Naturalization Services (INS).** The Immigration and Naturalization Service, Department of Justice, examines all persons arriving in the United States to determine their admissibility under the provisions of the Immigration and Nationality Act (66 Statute 163). Section 239 of the Act (Title 8, U.S. Code 1229) and Part 239, Title 8, Code of Federal Regulations, pertain specifically to aircraft and airports of entry.

b. **Customs Service (USCS).** The U.S. Customs Service, Department of the Treasury, controls the entrance and clearance of aircraft arriving in and departing from the United States and inspects the crew, passengers, baggage, stores, and cargo carried thereon (Tariff Act of 1930 and Section 1109 of the Federal Aviation Act of 1958). The baggage of any person arriving in the country may be inspected in order to view the contents. A determination can be made on items which are subject to duty, free of duty, or prohibited.

c. **Public Health Service (PHS).** The U.S. Public Health Service, Department of Health and Human Services, makes and enforces such regulations required to prevent the introduction, transmission, or spread of communicable diseases from foreign countries into the United States or its possessions. (Section 361, Public Law 410, 78th Congress.)

d. **Animal and Plant Health Inspection Service (APHIS).** The Animal and Plant Health Inspection Service, U.S. Department of Agriculture (USDA), provides inspection service at all airports with scheduled or unscheduled passenger aircraft arrivals from foreign countries. The purpose is to protect American agriculture by preventing the introduction of injurious plant and animal pests and diseases (Plant and Animal Quarantine Acts - 21 U.S.C. 111, 7 U.S.C. 151 et seq.).

e. **U.S. Fish and Wildlife Service (FWS).** The U.S. Fish and Wildlife Service, Department of the Interior, in accordance with the Lacey Act (Title 16 USC 3372) and other legislation dealing with the illegal trafficking of protected fish, wildlife and plants, is responsible (Public Law 93-205, Title 16 USC 1540(e)) for inspecting packages, crates, or other containers, including contents and all accompanying documents, upon importation or exportation.

93. PASSENGER FLOW SEQUENCE.

a. The internal FIS facilities layout should recognize passenger convenience by providing simple and direct passenger and baggage flow routes. Figure 6-1 provides a schematic diagram depicting passenger flow and functional adjacency requirements and sequences for areas at a typical FIS facility.

b. Deplaning international passengers move through a sterile corridor to the INS primary inspection queuing area. All foreign nationals and resident aliens are required to present themselves to an INS officer for primary screening. U.S. citizens proceed to dedicated U.S. citizen queuing areas for processing. Passengers who require additional INS/PI-IS processing are referred to the INS/PHS secondary inspection area for further examination prior to luggage retrieval.

c. Upon completion of INS **processing**, passengers **move** to the **baggage** claim area for luggage retrieval. Passengers **then** move to the USCS primary inspection queuing area for **USCS/APHIS** primary screening. Passengers requiring additional USCS or APHIS processing are referred to the appropriate secondary counter. After all necessary **screening/processing** is complete, **passengers** go directly to the cashier and/or exit.

94. PRECLEARANCE FACILITIES. The FIS staff **operate** predeparture (preclearance) inspection facilities in certain foreign countries for flights destined to the U.S. **However, these** preclearance facilities differ in certain aspects of the inspection sequence and required facilities from those in the U.S.

a. Passengers processing through a preclearance facility flow through the terminal area not controlled by the FIS to the airline check-in counters. After check-in, all passengers and their baggage should be **directed** toward the USCS counters in the FIS controlled area for primary **screening**.

b. Passengers not **requiring** additional **USCS/APHIS processing** go directly to the cashier or the baggage drop-off area, which is **immediately** adjacent to the USCS **processing** area. Passengers requiring additional **USCS/APHIS processing** are **directed** to the appropriate **secondary counter** located immediately **behind** the primary inspection area. After this **processing**, passengers proceed to **the** cashier or baggage drop-off area,

c. After Customs processing, passengers **deposit their baggage** onto **baggage** conveyors for transport to a sterile holding **area** until **ready** for loading onto **their** aircraft. **The baggage** is delivered to **the** aircraft under such physical and procedural controls **required** by **the** USCS to **ensure** its sterility.

d. From **baggage** drop-off, passengers proceed to the INS primary **counters** for primary screening. Passengers not requiring additional **screening** proceed to **the** sterile **departure** area.

e. Those **passengers requiring** additional **INS/PHS processing** are **directed** to the INS secondary inspection area. Upon completion of all INS/PI-IS processing, **passengers** admitted to **the** U.S. go to **the** sterile departure area.

f. **All** FIS cleared passengers are required to remain in a **sterile** waiting area until boarding the aircraft. No downstream concessions or **unauthorized** personnel are **allowed** in this **area**. **The** enplaning of passengers and loading of baggage requires a **procedure** which prohibits contact with **unauthorized** persons or objects when in transit from their respective **sterile** areas to the aircraft. Loading bridges (jetways) and corridor security requirements are the same as those for FIS facilities located in **the** United States.

h. Figure 6-2 provides a schematic diagram showing passenger flow and functional **adjacency** requirements and sequences at a typical preclearance **FIS** facility.

95. GENERAL DESIGN CONSIDERATIONS AND REQUIREMENTS.

a. Passenger routings should be as short and straight as possible and **unimpeded** by any form of obstruction, including crossflow traffic.

b. Strict segregation of deplaning passengers **between the** aircraft and **the** exit from **the** FIS is required. This is done to eliminate the possibility of items being passed from **international passengers** to the waiting public or the bodily substitution of a disembarking passenger by a member of the waiting public. Two flow routes for deplaning passengers are required; one for international traffic and one for **domestic** traffic. To the extent possible, flow routes for international traffic deplaning through each **carrier's** gate should **funnel** into a common passageway before entering the FIS area. Passenger routing should be so designed that there is **no** possibility of a crew member or passenger being able to bypass the inspection area.

c. Multilingual signs and pictorial (**international**) signs to **direct** traffic are required. (Refer to AC 150/5360-12, Airport Signing and Graphics.)

d. The **Federal inspection** area requires **separation** by a physical barrier from domestic passenger facilities. In the case of preclearance **operations**, the FIS **area** also requires **segregation** from **other international** traffic. /

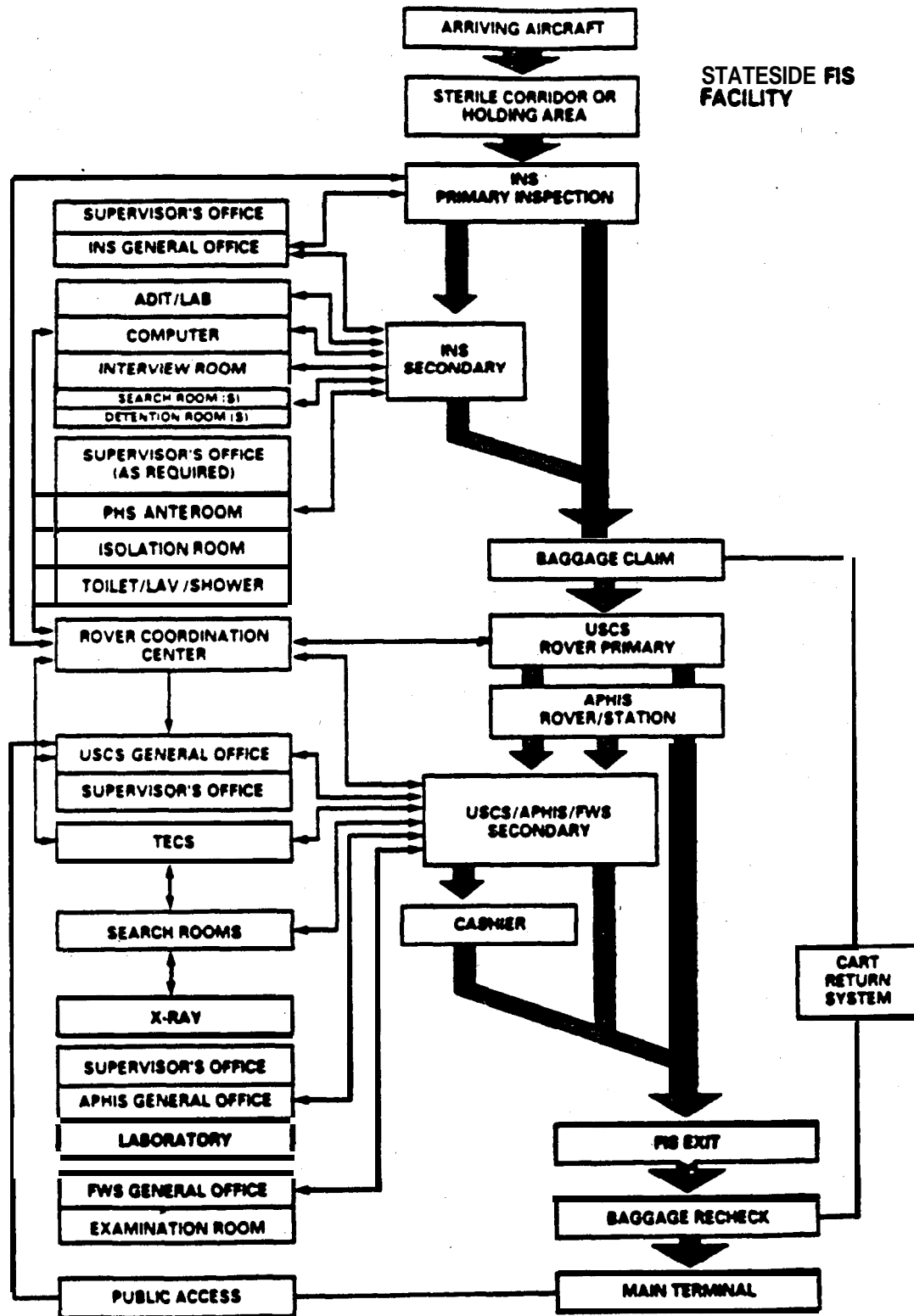

Figure 6-1. FIS Facility Functional Adequacy Diagram

e. Entrances and exits in the FIS area require controlled status. Adequate security precautions, including the installation of alarm devices on unlocked windows and doors, are required. Alarms sounding at a central point within the FIS complex are required.

f. At airports with sizable continuing passenger traffic (in-transit) to a foreign country or an onward U.S. port of entry (progressive clearance), a sterile waiting area should be provided to avoid needless congestion around the baggage claim area. The sterile area requires a design which **will** prevent co-mingling of in-transit passengers with domestic or previously cleared passengers.

g. It is necessary that baggage be delivered from the aircraft to the claim area in a manner which precludes access by unauthorized personnel and/or mixing with domestic or interline baggage. A secure, temporary storage facility close to the FIS area is required for baggage awaiting USCS inspection.

h. The arrival of baggage and deplaning passengers in the baggage claim area should coincide as nearly as possible. Only those passengers terminating at this facility should be in the **area**.

i. The baggage claim area should be of ample dimensions to prevent impediment in the flow of **passengers** from baggage claim to the FIS area.

j. In the FIS area, airline activities such as on-line or inter-line baggage processing, ticketing, **etc.**, are not authorized.

k. **Baggage** carts should be made available for passenger use to facilitate movement through the **inspectional** process.

l. Glare-free lighting is required at inspection points and in examination rooms. Indirect lighting of at least 90 foot candles (972 lux) is preferred. The FIS should be appropriately heated and air conditioned.

m. FIS facilities should normally be confined to one floor of the terminal building, preferably on the same level where the passengers deplane. Convenient access to the ground transportation vehicle loading platform on the **landside** of the terminal is highly desirable.

n. The cashier's booths need to be located so that they will not obstruct the **general flow** of passengers from the FIS area.

o. All doors leading out of the FIS area are required to be opaque to prevent visitors from observing the inspection process.

p. The main passenger exits need at least one set of double outward opening doors, preferably of an automatic type, located to facilitate the flow of passengers out of the area. **Also**, the area immediately outside the exit doors should be kept clear **from** congregation of **persons** so that passenger egress is not hindered.

q. All doors **not** designated for passenger use in the FIS **area** require automatic **door closers** and dead bolts.

r. Those doors in the FIS area which serve as emergency exits require: alarm exit lock with a crowd release bar, a loud gong alarm when the release bar is activated; and a mortise cylinder key lock which will deactivate the gong but will register on a remote indicator panel. Battery operated alarms are not acceptable on emergency alarm exit locks. *A capability for evacuating non-cleared passengers from the FIS area to a nearby holding area until resolution of an emergency should be considered in the building design process.*

s. If a visitors waiting room is provided, it should be at a sufficient distance from the FIS exit(s) so that passenger egress is not restricted. The room should be sized to house the normal volume **of** visitors. As visitor/passenger ratios vary among airports, a visitor/passenger ratio study should be accomplished before a waiting room is designed.

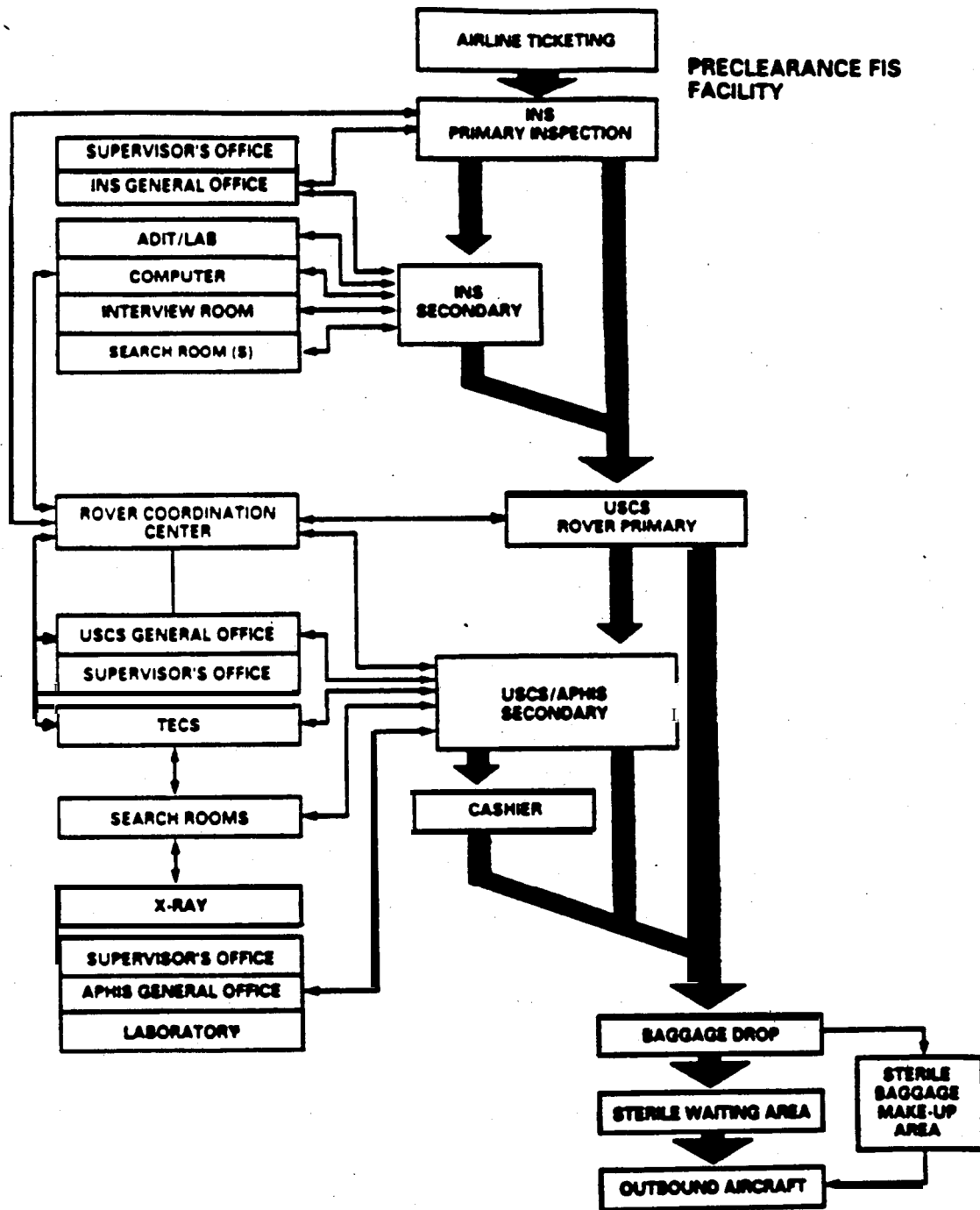

Figure 6-2. FIS Preclearance Facility Functional Adequacy Diagram

t. A closed circuit television system should be installed with cameras placed in all areas of concern to FIS agencies. These areas include loading bridges, sterile concourses, baggage delivery areas, the apron, and the entire FIS inspection area. Monitors should be located in an elevated command module.

u. Public telephones are not authorized in the FIS area.

v. Public toilets provided for deplaning passengers are required to meet FIS security standards and to be located prior to the INS inspection area.

96. INS REQUIREMENTS.

a. **Off-Line Secondary Inspection Waiting.** Secondary inspection counters, an interviewing room or rooms, and a waiting area are **required**.

b. **General Office.** Office space to accommodate inspectors when not at inspection counters is required. The minimum need is for one desk space per primary inspection booth and secondary position.

c. **Automated Equipment Room.** A lockable room with conduit connections for computer terminals to the primary and secondary inspection booths is required.

d. **Supervisor's Office.** The supervisor's **office** requires a location to permit the supervisor to view the primary inspection area through a clear glassed wall.

e. **Other Rooms.** Primary inspection booths, detention rooms, and lab equipment rooms are required. The INS should be consulted for details.

97. USCS REQUIREMENTS.

a. **Treasury Enforcement Communications System (TECS) Room.** The primary work station houses a cathode ray tube (CRT) unit connected to TECS. The rear of the secondary work station houses a **high-speed** printer which is connected to the CRT. This equipment is supplied, installed, and maintained by the USCS. However, provision for electrical/signal line hook-ups is required, free of charge, as part of the facility construction.

b. **Baggage Inspection Belts/Counters.**

(1) The USCS secondary inspection counters are located directly behind the USCS primary inspection area. The use of stainless steel counters is acceptable.

(2) A visual signaling system, able to be activated by the inspector, is required in a conspicuous location which is also visible from the exit side of the secondary inspection counters.

(3) At preclearance sites, a call button or similar arrangement for FIS **officers** to summon assistance from airport/local police is required.

(4) Provision of an intercom to facilitate communication between FIS primary, secondary areas, supervisors' offices and the command module is recommended.

c. **Searchrooms.** At least two windowless searchrooms are required within the USCS office area. These rooms require a minimum of 80 square feet (7.4 m²) each and a location beyond the baggage inspection area. For the safety of the USCS **officers**, each room needs: a push button to actuate a trouble buzzer and a call-light; outward opening doors; and a table (without drawers) and a bench both anchored or bolted to the floor or wall. The room cannot contain unsecured objects which can be used as weapons. The room's interiors should be aesthetically in keeping with other airport facilities.

d. **Cashier Booths.** At airports with USCS cashiers, a booth is required near the exit door positioned to not cause congestion at the exit area. The booth should be large enough to accommodate two cashiers and have proper heating ventilation, and lighting.

e. **Office Area for USCS Supervisors.** The principal supervisors' **office** should be so located in the USCS inspection area as to permit observation of the baggage inspection counters and the entire USCS area from the **office**. Space is required for an audio/visual indicator panel linked to USCS primary and secondary inspection areas. There should be no means of access to this office by, the general public (as distinguished

from arriving passengers). At high-volume airports, with an airport director or officer-in-charge, additional office space is necessary for this person and a secretary.

f. General Office Area. There should be some means of access by the general public (as distinguished from arriving passengers) to the **USCS** office without passing through the inspection area. This is to **facilitate** claiming of unaccompanied baggage, registration of personal effects, requests for USCS information, and providing for the entrance and clearance needs/requirements of the airlines.

g. Vault. A security vault is required in the USCS office area at major airports. The vault's walls, floor, and ceiling require a minimum of 8 inches (20 cm) of steel-reinforced concrete, or structural equivalent thickness, with a steel door and combination lock. The door and frame unit have the following specifications:

- (1) Thirty man-minutes against surreptitious entry;
- (2) Ten man-minutes against forced entry;
- (3) Twenty man-minutes against lock manipulation; and
- (4) Twenty man-minutes against radiological techniques;

At small general aviation airports, a steel safe with combination lock is required.

h. Agent Space. At airports with assigned Customs agents, **office** space commensurate with the number of officers assigned is required and should include lockable cabinetry to store service weapons.

i. Security Requirements. The security of the area is essential for protecting the integrity of baggage inspection. Structural treatment to support this need is required. Basic security requirements are as follows:

(1) Visual or physical contact between waiting friends and relatives with arriving passengers is not authorized until after **FIS** processing. Glass partitions are not authorized in new facilities. Glass partitions in existing facilities are required to be painted, frosted, or otherwise covered, to ensure privacy of the baggage examination.

(2) Appropriate measures to screen the processing area should be taken to eliminate visual or physical contact by friends or relatives of enplaning or deplaning passengers.

(3) The FIS area is a restricted area and may be used only for processing passengers. No airline interline counters, baggage return belts or other counters for commercial transactions are authorized within this area. Baggage carts should be provided by the airport since skycaps are not allowed in the area.

(4) A visual signaling system is required to enable the inspector to signal for assistance. These lights should not be readily visible to passengers.

98. PHS REQUIREMENTS.

a. The PHS requires office space and an isolation area. It is imperative that the PHS office, especially the isolation area, be located contiguous to the FIS inspection area. The isolation area consists of an ante-room with a lavatory and shower, an isolation room, and an adjacent private toilet with shower, water closet and lavatory. The **office** area and the entire isolation area may have their air supply (heating and cooling) needs met by the facility ventilation system. However, exhausted air from this area is required to be vented directly to the outside (without recirculation within the area or facility) by a separate **exhaust** system. The isolation area requires an area of not less than 160 square feet (14.9 m²) and the capability of accommodating a hospital bed, bedside stand, and chair.

b. The PHS requires primary inspection booths, similarly constructed to INS booths, in the INS primary inspection area at all airports which receive refugees.

c. PHS approval of proposed projects concerns the availability of adequate human waste removal and disposal from international **aircraft** arrivals. The PHS should be contacted for specific definition of requirements.

99. APHIS REQUIREMENTS.

a. APHIS inspection personnel examine cargo and aircraft for pests and for items of agricultural **inter-**est and cooperate with the USCS in the inspection of passengers' baggage. The space and facilities from which they operate require a location adjacent to the USCS baggage inspection area, with both physical and visual access to that area. The office and laboratory are ordinarily separated with a full partition and a door. Adequate lighting and electrical outlets are required. A clear glass panel (not floor to ceiling) with Venetian blinds is required in the wall between the office and baggage examination counters. Additional space for first line and higher level supervisors and administrative staff, as well as a small **climated** controlled room for detector dogs, may be required on a case-by-case basis.

b. The special equipment to be provided as part of the APHIS laboratory space consists of the following:

- (1) Double drainboard and stainless steel sink;
- (2) Undercounter storage cabinets;
- (3) Commercial type, heavy-duty garbage disposal unit (the size requirement based on peak hour passenger criteria);
- (4) Toilet facilities with shower (male and female); and
- (5) Counter top work space for microscopes and other such equipment.

c. APHIS requires secondary 'inspection counters in conjunction with Customs' secondary inspection counters. At some designated locations, their configuration will require a design to support secondary x-ray screening systems. A work counter is required in the **USCS/APHIS** baggage inspection area at those locations where 400 or fewer passengers per hour are processed. Diagrammatic details for the work counter are available from the APHIS.

d. APHIS approval of proposed projects is subject to availability of adequate international aircraft garbage and refuse disposal facilities. Adequate facilities consist of either an incinerator, garbage cooking or sterilizing apparatus, or equipment that grinds garbage and refuse for discharge into an approved sewage system. The system or combination of systems selected requires a capability of handling all the garbage and refuse from arriving international carriers on a daily basis. The sewage system utilized by the airport, as well as the method of collection and transport of the garbage and refuse, require APHIS approval. Disposition of any part of foreign garbage at landfills is not-authorized unless it has **first** been processed in an acceptable manner. Without approved garbage handling facilities, galley cleaning or recatering is not permitted, and, after passenger disembarkment, aircraft are required to fly either to an approved U.S. airport or a foreign destination.

e. A predeparture clearance for agriculture purposes only is presently carried out in Hawaii, Puerto Rico, and the U.S. Virgin Islands. This clearance includes examination of passengers' baggage, cargo, and the aircraft's quarters, stores, and cargo pits. Such inspections in Hawaii and Puerto Rico are conducted by APHIS personnel. At airports where this predeparture inspection is performed, adequate examination counters (configured to support x-ray systems, as required) queuing space, checked baggage security, and accompanying **office** and laboratory facilities are required. Details regarding these requirements can be obtained from the APHIS.

100. JOINT FIS EMPLOYEE REQUIREMENTS.

a. **Employee Locker Rooms.** Rooms of sufficient size to permit one locker for each full-time **inspec-**tional employee assigned to passenger processing are required for male and female employees.

b. **Employee Toilets.** Men's and women's toilets are required for employees and should not be **acces-**sible to the public.

c. **Lunch/Break Room.** The area provided for inspection personnel requires a counter type sink and space for the installation of a stove and refrigerator. It is recommended that this room be in close proximity to the passenger processing area to minimize passenger processing delays.

d. Conference/Training Room. A conference training room should be provided at major airports for meetings and the training of inspection personnel.

101. SPACE AND FACILITY REQUIREMENTS. Table 6-1 depicts space and facility requirements for typical FIS facilities at international airports. These requirements are based on one inspection area in a terminal and **one** terminal at an airport. Detailed drawings and specifications for all work stations, inspection belts, and electrical requirements are available through the respective FIS national headquarters.

102. **APPROVAL OF FIS FACILITY PLANS.** Approval of FIS facility plans and specifications is the joint responsibility of the **USCS**, APHIS, and INS. INS approves for INS and PHS. Approvals for FIS plans may only be obtained from the national headquarters. Addresses and phone numbers of the national headquarters of the FIS are listed in appendix 3.

103. - 115. RESERVED.

Table 6-1. FIS Space and Facility Requirements at International Airports

FEDERAL INSPECTION SERVICES			
SPACE AND FACILITY REQUIREMENTS AT INTERNATIONAL AIRPORTS			
• Passengers Per Hour	800	1400	2000
U. S. IMMIGRATION & NATURALIZATION SERVICE			
# OF PIGGYBACK BOOTHS	7	12	17
GENERAL OFFICE SPACE	1300	2150	3000
CONFERENCE/TRAINING	200	250	300
BREAK/LUNCH ROOM	200	200	300
SECONDARY INSPECTION AREA	250	375	600
INTERVIEW ROOM(S)	80(1)	80ea.(2)	80ea.(3)
SUPERVISOR'S OFFICE(S)	150(1)	150ea.(2)	150ea.(2)
PORT DIRECTOR'S OFFICE	200	200	225
CLERK/RECEPTION	160	160	160
EMPLOYEE LOCKER & TOILET	as required	as required	as required
ADIT/LAB	150	150	150
STORAGE	100	100	100
HOLD ROOMS W/TOILET FACILITIES	225	225	225ea.(2)
COMPUTER ROOM	100	100	100
U. S. PUBLIC HEALTH SERVICE			
SUPERVISOR'S OFFICE	200	200	200
CLERK/RECEPTION	150	150	150
GENERAL OFFICE SPACE	400	400	400
ISOLATION AREA	160	160	160
U. S. CUSTOMS SERVICE			
# OF PIGGYBACK BOOTHS	7	12	17
CUSTOMS SUPERVISOR	300	400	500
CUSTOMS OFFICE	800	1400	2000
IN-BONO ROOM			
(not required for preclearance)	200	400	500
CASHIER(S)	as required	as required	as required
TECS ROOM (lockable room)	150	200	200
SEARCH ROOMS	80 square feet. Should be located near the front of baggage modules. Minimum 2 per FIS facility		
PUBLIC SPACE W/COUNTER	150	200	250
STORAGE ROOM	150	200	200
AIRPORT DIRECTOR AND SECRETARY	350	350	350
CONFERENCE AND TRAINING ROOM	400	500	600
CUSTOMS PATROL	300	400	500
EMPLOYEE LOCKER & TOILET	as required	as required	as required
ANIMAL & PLANT HEALTH INSPECTION SERVICE			
OFFICER IN CHARGE	200	200	200
INSPECTOR'S OFFICE	440	750	1200
LABORATORY	220	400	450
GARBAGE DISPOSAL UNIT (HP)	5	10	10 or larger
SUPERVISOR'S OFFICE	150	250	300
CLERK-STENOGRAPHER	-	150	250
STORAGE	100	100	100
CONFERENCE/TRAINING	150	200	200
BREAK/LUNCH ROOM	150	200	200

Laboratory requirements: Stainless steel or formica counter top and drain-board stainless steel double sink, garbage disposal unit, under-counter cabinets, counter space for microscope and identification work, lockers, and at least two 220V outlets. At locations not having or expecting scheduled service office-laboratory space size requirements will vary from above requirements depending upon expected volume of charter traffic. Space requirements under these conditions will usually be less than shown and will be negotiated with the headquarters office of the Animal and Plant Health Inspection Service noted on frontispiece.

* This ratio can only be achieved under optimum conditions. Factors such as baggage delays, origin of flight, passenger mix, etc. are key determinants which could possibly mitigate against achieving these figures. These issues must be considered during early planning phases.

104

CHAPTER 7. ACCESSIBILITY TO INDIVIDUALS WITH DISABILITIES AND SPECIAL NEEDS USERS

116. GENERAL. This chapter summarizes the requirements imposed on airport terminal facilities to assure full accessibility to individuals with disabilities. These requirements are contained in the **Americans with Disabilities Act (ADA)** of 1990, 14 CFR Part 382, Nondiscrimination on the Basis of Handicap in Air Travel, which implements the **Air Carrier Access Act** of 1986, and 49 CFR Parts 27, **Nondiscrimination on the Basis of Handicap in Programs and Activities Receiving or Benefiting from Federal Financial Assistance**, which implements the **Rehabilitation Act** of 1973, as amended, and the **ADA**, and 37, **Transportation Services for Individuals with Disabilities (ADA)**, which implements the **ADA within the air transportation industry**, include conditions applicable to airport terminal buildings.

117. MINIMUM BUILDING DESIGN STANDARDS. ADA requirements apply to any facility occupied after January 26, 1993 for which the last application for a building permit or permit extension is certified as complete after January 26, 1992. 49 CFR Part 27 requires new airport terminal facilities designed and constructed with Federal funds to meet the ADA standards set forth in Appendix A of 49 CFR Part 37.

118. SPECIFIC REQUIREMENTS FOR AIRPORT TERMINALS. In addition to meeting minimum ADA building standards, 49 CFR Part 27 imposes the following facility and equipment requirements for new airport terminals:

a. That the basic terminal design shall permit efficient entrance and movement of persons with disabilities, while at the same time giving consideration to their convenience, comfort, and safety. It is essential that the design, especially concerning the location of elevators, escalators, and similar devices, minimize any extra distance that wheelchair users must travel compared to persons without a disability, to reach ticket counters, waiting areas, baggage handling areas, and boarding locations.

b. That the international accessibility symbol is displayed at accessible entrances to terminal buildings.

c. That the ticketing system is designed to provide persons with disabilities with the opportunity to use the primary fare collection area for purchasing tickets.

d. That baggage areas are accessible to persons with disabilities, and the facility is designed to provide for efficient handling and retrieval of baggage by all persons.

e. That boarding by jetways and by passenger lounges are the preferred methods for movement of persons with disabilities between terminal buildings and aircraft. Where this is not practicable, operators may accommodate this requirement by providing lifts, ramps, or other suitable devices not normally used for movement of freight, which are available for enplaning and deplaning wheelchair users.

f. That at each public telephone center in a terminal, at least one clearly marked telephone is equipped with a volume control or sound booster device and with a device available to persons with disabilities, which makes telephone communication possible for persons with hearing impairment and/or using wheelchairs.

g. That each airport ensures that there is sufficient teletypewriter (TTY) service to permit hearing-impaired persons to communicate readily with airline and other airport personnel.

h. That several spaces adjacent to the terminal building entrance, separated from the main flow of traffic, and clearly marked, are made available for the loading and unloading of passengers with disabilities from motor vehicles; and that the spaces allow individuals in wheelchairs or with braces or crutches to get in and out of automobiles on to a level surface suitable for wheeling and walking.

i. That curb cuts or ramps with grades not **exceeding** 8.33 percent **are** provided at crosswalks between parking areas and the terminal.

j. That with multi-level parking, ample and clearly marked **space** is **reserved** for ambulatory and semi-ambulatory individuals with disabilities on the **level** nearest to the ticketing and boarding portion of the terminal facilities.

k. That in multi-level parking areas, elevators, ramps, or other **devices** which can accommodate wheelchair users are easily available. [Note: AC 150/5220-21, Guide Specifications for Lifts Used to Board Airline Passengers with Mobility Impairments, should be consulted for additional information in this matter.]

l. That the environment in the waiting area/public space of the airport terminal facility gives confidence and security to the person with a disability using the facility. This means that not only is the space to be designed to accommodate individuals with a disability, but that it is also to contain **clear** directions for using all passenger facilities.

m. That airport terminal information systems take into consideration the needs of individuals with disabilities. Although the primary information mode required is visual (words, letters, or symbols), using lighting and color, coding, airport **terminals** are also required to have facilities providing oral information.

n. That public service **facilities, such** as toilets, drinking fountains, telephones, travelers aid, and first-aid medical facilities are designed in **accordance** with **the** Uniform Federal **Accessibility** standards (UFAS), as supplemented or superseded by the ADA Accessibility Guidelines (ADAAG) set forth in 49 CFR Part 37, Appendix A.

119. EXISTING TERMINALS. The ADA of 1990 **requires** all existing terminals to have incorporated the required non-structural accessibility features by **January 26, 1992**. Structural changes should be accomplished as soon as practicable, but no later than **January 26, 1995**.

120. OTHER USERS WITH SPECIAL NEEDS. Some airport terminals may serve significant numbers of older travellers, families travelling with **infants** or young children, or others, not normally considered having a disability, but having special facility and services **requirements**.

a. Higher proportions of older travellers may warrant more seating in gate lounge and terminal waiting areas than otherwise provided. Mobility aids such as moving walkways or airline courtesy **carts** may be more frequently justified, and may require wider concourse designs. However, slightly slower moving rates may be necessary to facilitate access and egress, and keeping anxiety at a minimum. Emphasis on appropriate lighting, high visibility signing and other public information systems may also be **warranted**.

b. Airports serving major tourism areas are likely to accommodate increased numbers of children. Passenger waiting areas may be designed with **space** for children to play. Public lavatories, drinking fountains, and other amenities should be easily accessible by children. The provision of **diaper** changing, baby bottle warming, and private **infant** feeding facilities should be considered.

121. - 130. RESERVED.

CHAPTER 8. MISCELLANEOUS DESIGN CONSIDERATIONS

131. AIRPORT SECURITY. FAR Part 107, Airport Security, imposes aviation security requirements on operators of the scheduled passenger operations of a certificated holder (airline) required to have a security program by FAR Part 108 or a foreign carrier required to have a security program by FAR 129.25. FARs 121.538 and 129.25 impose certain security responsibilities on air carriers operating into U.S. airports. These require the screening of passengers and baggage before entering an aircraft or areas accessible to an aircraft. The terminal designer **should** take these requirements into account in developing an effective terminal design. Some important aspects of airport security are discussed in succeeding paragraphs.

a. **Security Inspection Stations.** Requirements for security inspection stations are discussed in paragraph 73. Although primarily the responsibility of the individual airlines, their location and impact on terminal operations requires consideration by the terminal planner.

b. **Access to Air Operations Area.** The Air Operations Area (AOA), as per FAR Part 107, is that portion of an airport designed and used for landing, taking off, or surface maneuvering of airplanes. Airport operators have the responsibility to secure this area and prevent access **by** unauthorized persons and vehicles. This can be done by installing security fencing, and limiting and controlling the use of gates, doors, and passageways providing direct or indirect access to the AOA. Passengers are permitted access to the AOA only after undergoing screening. Vehicles using service roads are required to pass through controlled gates.

c. **Doors.** Doors leading from unsecured areas of the terminal to the AOA which are not under the visual control of authorized personnel are required to be locked or equipped with alarms signalling unauthorized use. Fire codes usually permit the locking of emergency exits provided they contain panic knock-out devices.

d. **Security Fencing.** Security fencing can vary in design, height, and type, depending on local security needs. Generally, it is recommended that the fencing be, as a minimum, No. 10 gauge, galvanized steel, chain link fabric installed to a height of 8 feet (2.5 m), and topped with a three strand (12 gauge) barbed wire overhang. The latter should have a minimum 6-inch (15 cm) separation between strands and extend outward at a 45 degree angle from the horizontal. Fence posts should be installed at no greater than 10-foot (3 m) intervals and be located within 2 inches (5 cm) of any wall or structure forming part of the perimeter. It is suggested that a 10 to 20 feet (3 to 6 m) wide cleared area be provided adjacent to and immediately outside of the perimeter fencing. Gates should be constructed with materials of comparable strength and durability and open to an angle of at least 90 degrees. Hinges should be such as to preclude unauthorized removal. Gates providing access to and from public roads require controlled **use** procedures to prevent unauthorized access to the AOA. Additional guidance is available in AC 150/5370-10, Standards for Specifying Construction of Airports.

e. **Observation Decks.** Terminal observation areas or decks should be enclosed or contain effective barriers to deter and prevent unauthorized AOA access or the hurling of dangerous objects at parked aircraft.

f. **Security Lighting.** Security lighting of airports and terminal areas is generally an inexpensive means of providing additional deterrence/protection against unauthorized intrusion into aircraft operating areas. Lighting requirements are dependent on the local situation and the areas to be protected. For perimeter lighting, lighting units should be located within the protected area and above the perimeter fence to light areas on both sides of the fence. Light units should be oriented and shielded to prevent an unwanted glare safety hazard to aircraft operations and adjacent vehicular roadways and unnecessary irritation to nearby residences. It is recommended that security lighting systems be connected to an emergency power source.

g. **Lockers.** Coin-operated lockers provide a valuable and desired service to the traveling public. However, they can be a convenient place for the storing and detonation of bombs and incendiary devices. From a security viewpoint, the best location for these lockers is within sterile **areas** beyond the security screening station area. If such sterile areas are not practicable, the lockers should be so located in public areas to minimize the **deleterious** effects of an explosion. The construction of blast-proof barriers around the locker area is advisable and should be considered.

h. Security Office. Lockers, toilets, and rest rooms should be provided for security screening personnel. In addition, an area for a security/police office and a **detention/interrogation room** is recommended. At large airports, those facilities may be a part of the airline leased space; at small airports the use of common facilities may make an area under direct airport control preferable.

i. General Aviation Access. Airport legislation requires that passengers using general aviation aircraft be provided access to the terminal building if Federal funds were utilized for terminal development. For security reasons, such access also requires control so that the screening system within the terminal building is not circumvented. Separate general aviation parking areas adjacent to the terminal building with controlled terminal building access can satisfy the access requirement and maintain security of the AOA. FAA security personnel should be consulted in designing the terminal building and aircraft parking aprons to satisfy this requirement.

j. Guidance. FAA regional aviation security personnel should be contacted for advice on the location and design of security facilities. In addition, the following publications, current editions, as applicable, should be reviewed:

- (1) AC 107-1, Aviation Security-Airports;
- (2) AC 108-1, Air Carrier Security;
- (3) AC 129-3, Foreign Air Carrier Security; and

(4) Technical Report, Recommended Security Guidelines for New Airport Construction and Major Renovation.

132. ARCHITECTURAL TREATMENT.

a. It is Federal policy to support projects which contribute to the architectural and cultural heritage of local communities. In accordance with this policy, airport sponsors are encouraged to develop, use, and incorporate design, art, and architectural treatment to reflect local customs and community history. This can be accomplished in conjunction with a functional, safe, and efficient airport terminal facility.

b. Architectural treatments for the exterior of terminal buildings and structures should avoid materials and configurations which can interfere with the airport's operational activities. For example, the use of mirrored exterior glass walls on or adjacent to airports may adversely affect airport operations. The thin metallic coating used in mirrored glass can reflect back signals from various airport navigational and communications equipment and cause inaccuracies in their use. Mirrored glass walls facing aircraft operational areas can also cause undesirable and unsafe glare and reflections to a pilot's vision. By selective siting, orientation, and shielding, these adverse effects can be eliminated.

c. The Department of Transportation publication "A Study of Airports - Design, Art, & Architecture" is directed at those airport operators and their architects who are considering the design and construction of new and expanded airport terminal facilities. Concepts related to design, art, and architecture in public airports are illustrated and discussed.

133. ENERGY CONSERVATION. Airport terminals require higher energy consumption than most public buildings; This is primarily due to their generally unprotected locations, the high heat loss/gain resulting from the movement of people and baggage through the building, and their usual 24 hours a day operation. The designer should consider energy conservation early in the planning of a terminal building in order to reduce dependence on increasingly costly fossil fuels. AC 150/5360-11, Energy Conservation for Airport Buildings, provides guidance in promoting energy conservation measures for airport buildings. As a minimum, the following suggested considerations should be made in designing a terminal facility with energy conservation in mind:

a. For terminal additions, the existing **mechanical systems** should be analyzed to determine whether replacement systems or improvement to the present system can be made to make the system more energy efficient.

b. Ample insulation and select building materials, **system components**, and design/construction techniques which place a low demand on energy consumption and require minimal maintenance should be utilized.

c. Building design should incorporate vestibule automatic doors and wind shields, as appropriate, at building entrances, loading/unloading areas, and openings for baggage conveyors and carts.

d. The use of large window arcs should be limited, particularly at localities which are subject to temperature extremes.

e. Adequate controls for heating, cooling, and lighting to permit varying the use of these systems and the implementation of energy conservation measures should be provided.

f. The potential and cost/benefits for designing and installing an active or passive solar system for heating and/or cooling the building should be analyzed. Such systems can be used effectively to provide primary or supplemental heating/cooling and thereby reduce operational costs.

134. SEISMIC SAFETY. Airport terminal buildings should be structurally designed to appropriate seismic standards. With respect to Federally owned, leased, assisted, or regulated buildings, Executive Order (E.O.) 12699, Seismic Safety of Federally Assisted or Regulated New Building Construction, January 5, 1990, under the authority of The Earthquake Hazards Reduction Act of 1977 (42 U.S.C. 7701 *et seq.*) requires the use of nationally recognized private sector seismic safety standards and practices. A rule under 49 CFR Part 41, implementing E.O. 12699 in the U.S. Department of Transportation, was issued on June 14, 1993. The rule states that any building constructed with Federal financial assistance after July 14, 1993, must be designed and constructed in accordance with seismic standards approved by the Federal Aviation Administration under 49 CFR 41.120.

135. - 145. RESERVED.

CHAPTER 9. AIRPORT GROUND ACCESS AND CIRCULATION SYSTEMS

146. GENERAL. Ground access systems serve passengers, employees, and other airport users traveling to and from the airport. Circulation systems within the airport boundaries should minimize congestion and support efficient access to the passenger terminal. Ground access systems extend beyond the airport boundaries and must function within the context of regional transportation systems and the policies of government agencies typically unrelated to the airport's operation. A thorough analysis of motor vehicle traffic flows associated with current and projected future air passenger demand is essential to assure that ground congestion does not become an unanticipated constraint on a passenger terminal's performance.

147. PLANNING STUDIES.

a. Ground access facilities—including access roads and interchanges, transit links, parking facilities, staging areas for taxis and other public transport services, and the terminal curb—are generally addressed as a major element of overall airport master planning or terminal building design (see Chapter 1). The assumptions about demand that guide access system decisions must be consistent with those used for airport master planning and terminal building design.

b. Ground access systems generally depend upon regional highway and transit facilities that carry traffic unrelated to the airport. Periods of peak demand and resulting congestion on these regional facilities may not correspond to those for the airport, but may influence airport facilities planning and design. Accordingly, local and regional transportation authorities, as well as private and public operators of ground transport services, should be included in the planning and design process.

c. Figure 9-1 outlines the process typically followed in ground access systems planning and design. This process may be followed in parallel with planning and design of other elements of the passenger terminal, or as an independent activity when ground access problems are faced at an otherwise adequate airport facility. The inventory phase collects data on projected air transport demand, airline schedules, airport operating policies, and ground transport facilities and services. Demand forecasting uses these data to develop projections of motor vehicle traffic, passenger demand, and parking demand on annual, seasonal, monthly, daily, hourly, and peak hour bases. Demand-capacity analyses determine the facilities required to accommodate these demand forecasts and identify alternate facilities feasible for application at the airport. Evaluation of the service quality of facility alternatives and their comparison to performance and cost standards leads to the selection of the optimum alternative.

148. CIRCULATION SYSTEM CONFIGURATIONS. The layout and types of terminal concepts at an airport determine the integration of the components to form the airport circulation system. The following paragraphs discuss some of the more typical airport circulation configurations:

a. **Centralized Layout.** When the terminal complex consists of a single building or a contiguous series of buildings, the ground transportation system usually consists of sequentially and centrally located components. Except for vertical or horizontal separation, which may exist for originating and terminating passenger vehicles, all passenger-related vehicles normally pass through the same series of roadways. Also, public parking and car rental facilities are centrally located. Many commercial service airports in the United States use this type of system, known as the centralized ground access concept. Some example airports are Chicago O'Hare, San Francisco International, Los Angeles International, Atlanta Hartsfield, Washington National, and Fort Lauderdale-Hollywood International. Figure 9-2 schematically presents this concept. This concept permits terminal unit expansion along the existing terminal area access road without loss of the original ground access system concept.

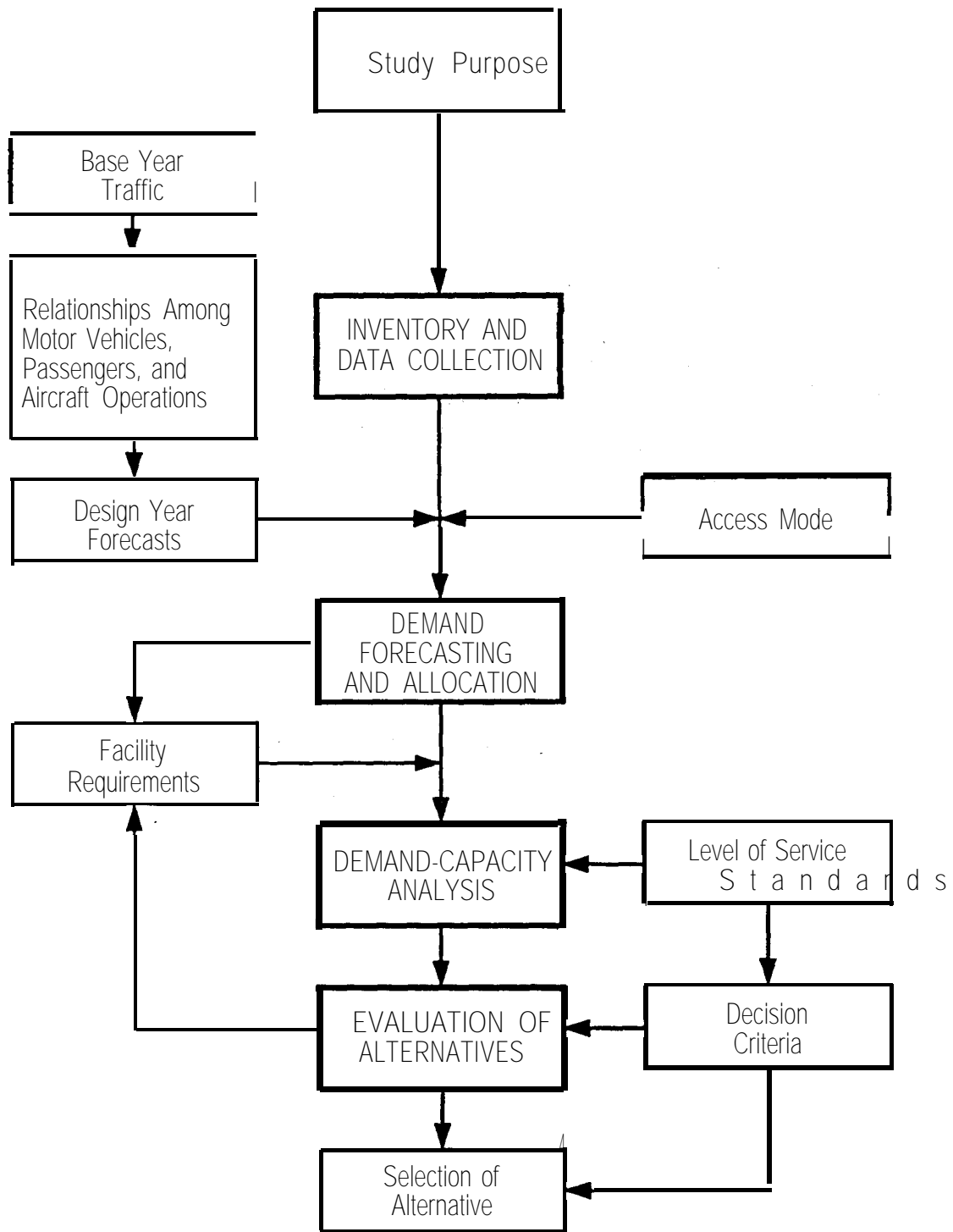

Figure 9-1. Outline of Ground Access System Planning Process

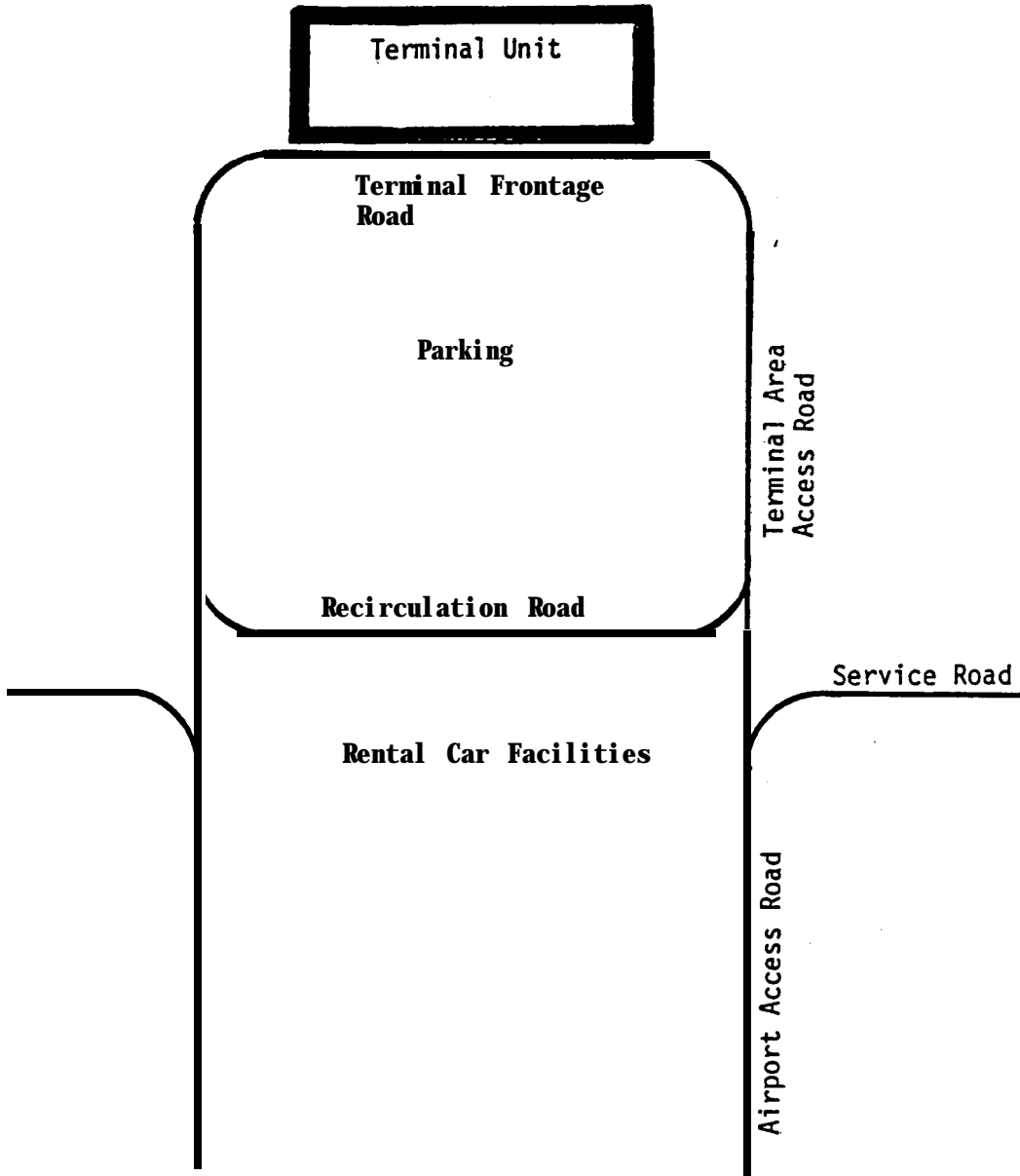

Figure 9-2. Centralized Ground Access Concept

b. Segmented Layout. Division of the terminal building into originating and terminating passenger sides or grouping of airlines on either side of the building achieves flow separation on a horizontal basis. Originating passengers use one set of terminal **frontage** roads and terminating passengers the other; or **specific** airlines may group themselves on either side of the terminal unit. Orlando International, Jacksonville, and Greater Cincinnati airports use this type of ground access system layout called the segmented ground access concept. (See Figure 9-3.) This **layout also** permits expansion through terminal unit extension with retention of the same ground access system concept.

c. Decentralized Layout. When the terminal complex consists of unit terminal buildings, vehicle flow separation on terminal access and frontage roads is possible. Airport access and terminal access roads funnel traffic to and from separate terminal facilities. Parking and car rental facilities are grouped on a terminal unit basis. Examples of this type of system use, the decentralized ground access concept, include Kennedy International and Kansas City International airports. (See Figure 9-4.) Expansion of the system is by addition of terminal units around the terminal access road with separate terminal frontage roads.

d. Unitized Layout. In some cases, the terminal system may consist of a series of terminal building located in linear fashion. Access is from a centrally located roadway. Dallas-Fort Worth International and Houston Intercontinental airports use this type of system, the unitized ground access system concept. (See Figure 9-5.) System expansion is usually accomplished by adding terminal units between terminal area access roads.

149. AIRPORT ROADS. The four types of airport roads are primary airport access roads, terminal area access roads, terminal frontage roads, and service roads.

a. Primary airport access roads provide access to the airport from the neighboring community road system. A capacity per lane of 700 to 800 vehicles per hour should be provided for at-grade interrupted flow conditions. This value approximates the flow relationship for urban arterial highways with signalized intersections; average speed range of 20 to 25 miles per hour (30 to 35 km/h); and, a demand volume to capacity ratio of approximately 0.80. For limited access highways with grade separations under uninterrupted flow conditions, the recommended design is one lane for each 1,200 to 1,600 vehicles per hour. This value approximates the flow relationship for urban freeways; average speeds from 40 to 50 miles per hour (60 to 80 km/h); and a demand volume to capacity ratio approximating 0.60. A lane width of 12 feet (3.6 m), with a minimum of two lanes in each direction, is recommended.

b. Terminal area access roads service airport passengers, visitors, and employees and connect primary airport access roads with terminal buildings and parking facilities.

(1) These roads should be sufficiently long to permit smooth channeling of traffic into appropriate lanes for safe access to terminal curbs, parking lots, and other public facilities. To avoid driver confusion, ample separation should be provided at locations where drivers must make directional choices. Not more than two choices should be required of a driver at any location. Traffic circulation in front of the terminal should, normally, be one-way and counter-clockwise for convenience of right-side loading and unloading of vehicles. Recirculation of vehicles to the passenger terminal should be permitted by providing road sections to link the ingress and egress lanes of the access road. When several buildings exist, it may be advisable to provide more than one terminal road.



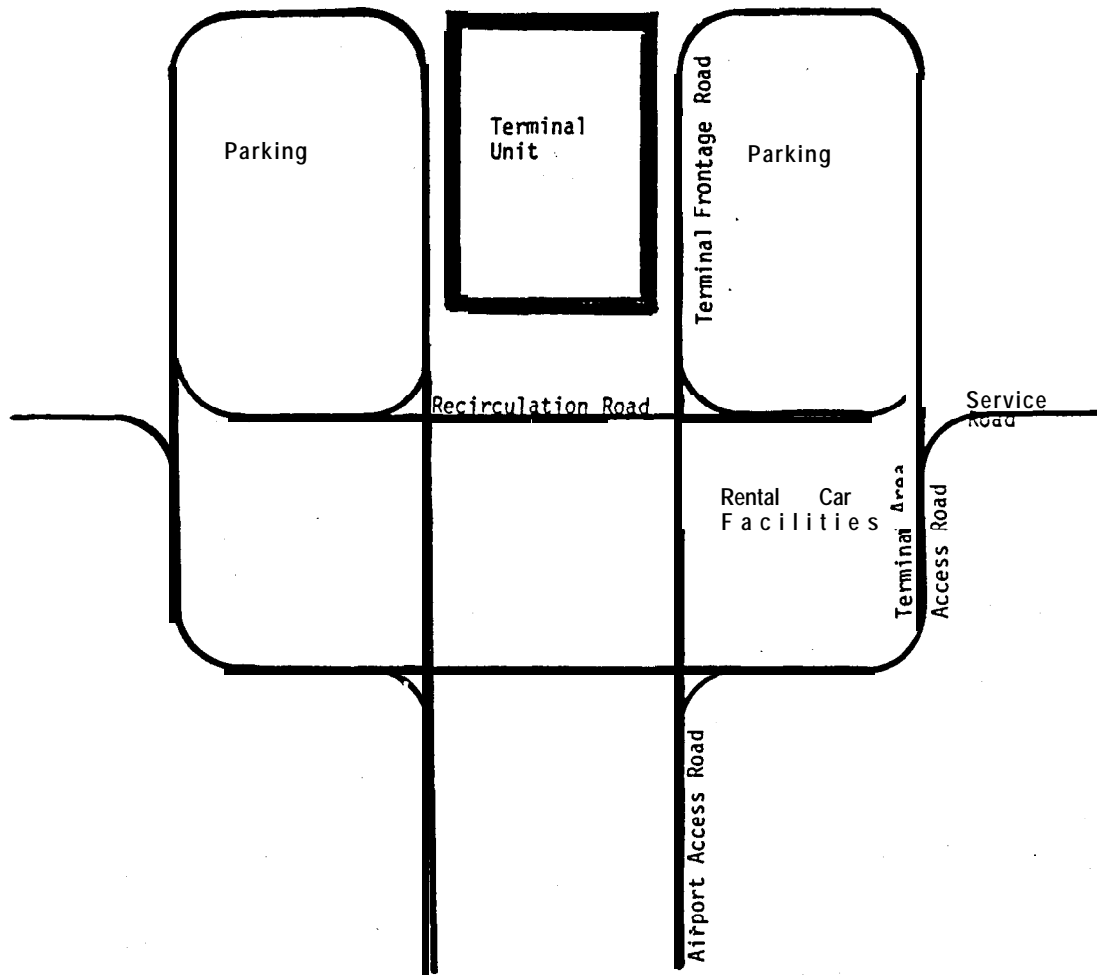

Figure 9-3. Segmented Ground Access Concept

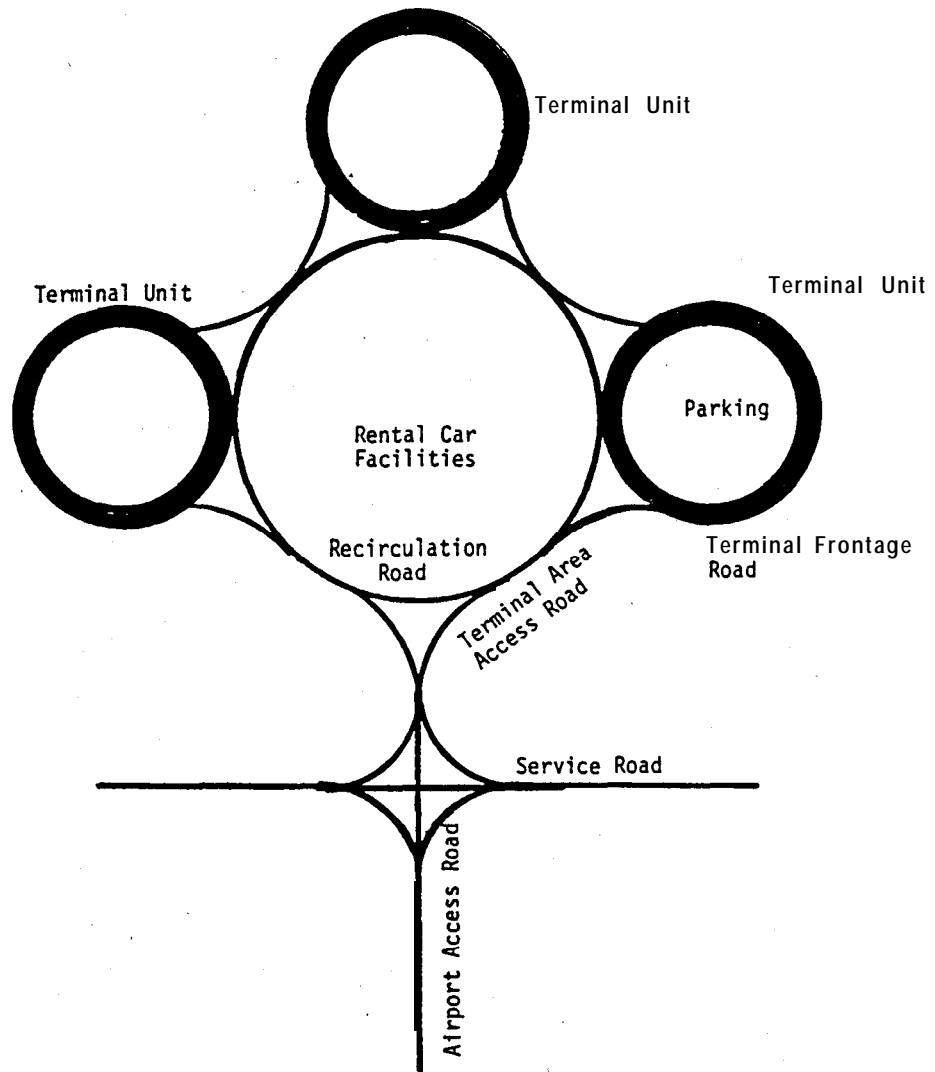

Figure 9-4. Decentralized Ground Access Concept

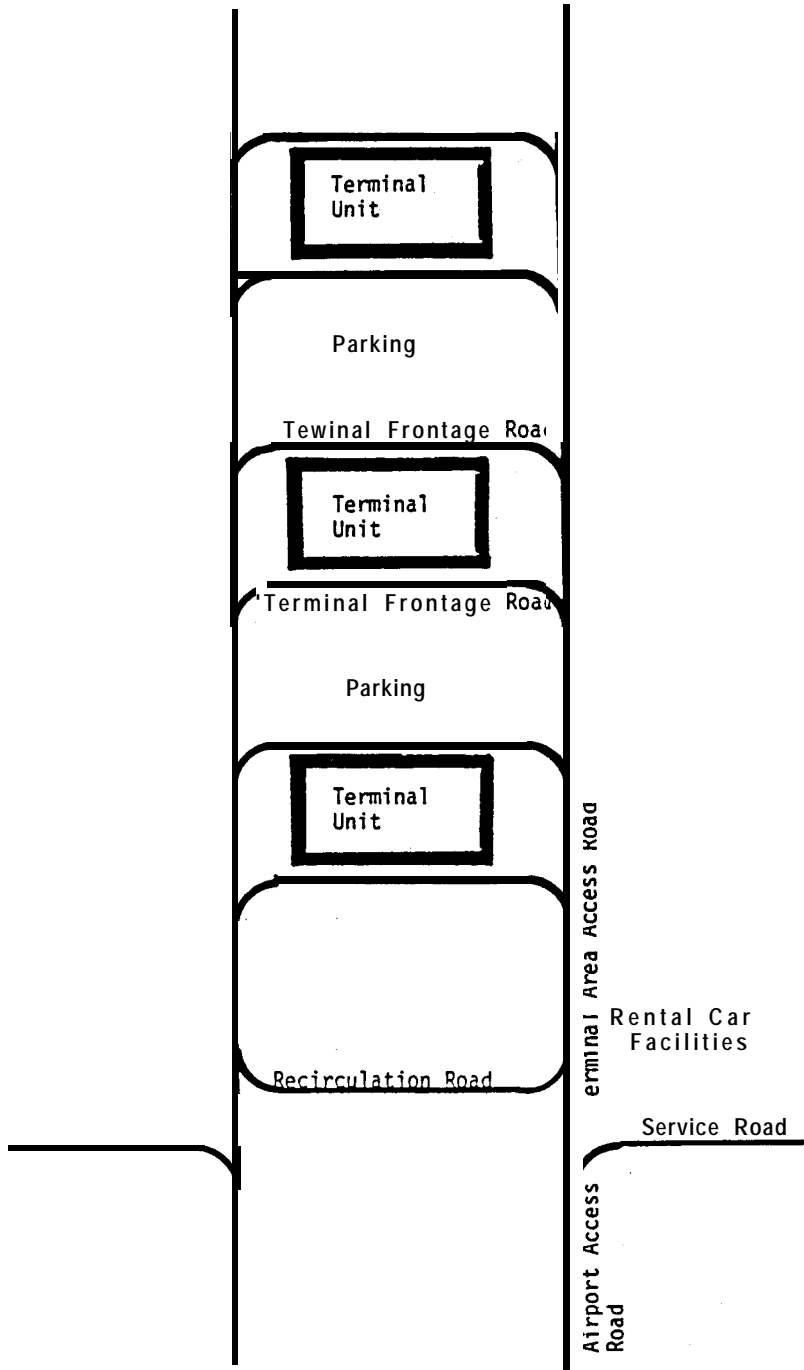

Figure 9-5. Unitized Ground Access Concept



(2) **Traffic** streams should be separated at an early stage with appropriate signing to avoid congestion and assure lower traffic volumes on each of the terminal frontage roads. Terminal area access roads should be planned to accommodate 900 to 1,000 vehicles per lane per hour. A minimum of two 12 foot (3.6 m) lanes should be provided. For recirculation roads, each lane should serve 600 vehicles per hour. If only one recirculation lane is provided, its width should be 20 feet (6 m) to accommodate stalled vehicles. For multiple recirculation lanes, the standard lane width is 12 feet (3.6 m).

c. **Terminal frontage roads** distribute vehicles directly to terminal buildings. **Since** considerable merging from through lanes to and from the **curbfront** occurs **on** these roadways, at least **two** lanes should be provided adjacent to the curb. The inside lane, sized at 8 feet (2.4 m), provides terminal curbfrontage and the 12 foot (3.6 m) outside lane serves through traffic and maneuvering to the terminal curbfrontage. **While** planned capacity for the outside lane should be 300 vehicles per hour, the inside lane is considered to have no throughput capacity. Additional 12 foot (3.6 m) through lanes should **be** provided at a rate of 600 vehicles per lane per hour. The terminal frontage is a critical element in the performance of the airport ground access system. Accordingly, to avoid the congestion caused by the inevitable double parking, a minimum of four lanes adjacent to the terminal curb is recommended. Four lanes are also recommended when terminal arrivals and departures are on the same level. (See Figures 9-6 and 9-7.)

d. Service roads are divided into two user categories - general and restricted.

(1) General-use service roads are used for the delivery of goods, services, air cargo, flight kitchen supplies, and the like. At very large airports, to relieve congestion on airport terminal access roads, it is desirable to provide service road entrances and interchanges either before or shortly after entering the airport site. At low activity airports, the service and primary **airport** access roads may be coincidental.

(2) Restricted-use service roads and traffic lanes are limited to such traffic as maintenance, tire and rescue, fuel, baggage, freight, and aircraft service vehicles. Those roads or sections of roads providing access to aircraft operating and parking areas require control points for adequate area security.

(3) The recommended hourly lane capacity is 600 to 1,200 vehicles. Since a major portion of **the** road traffic is from trucks, the lower value should be used in preliminary design. The typical vehicle speed is 15 to 20 miles (25 to 33' km) per hour and frequent curb cuts are required for access to airport service facilities. Usually, these roads are two-way in nature with 12 foot (3.6 m) lane widths.

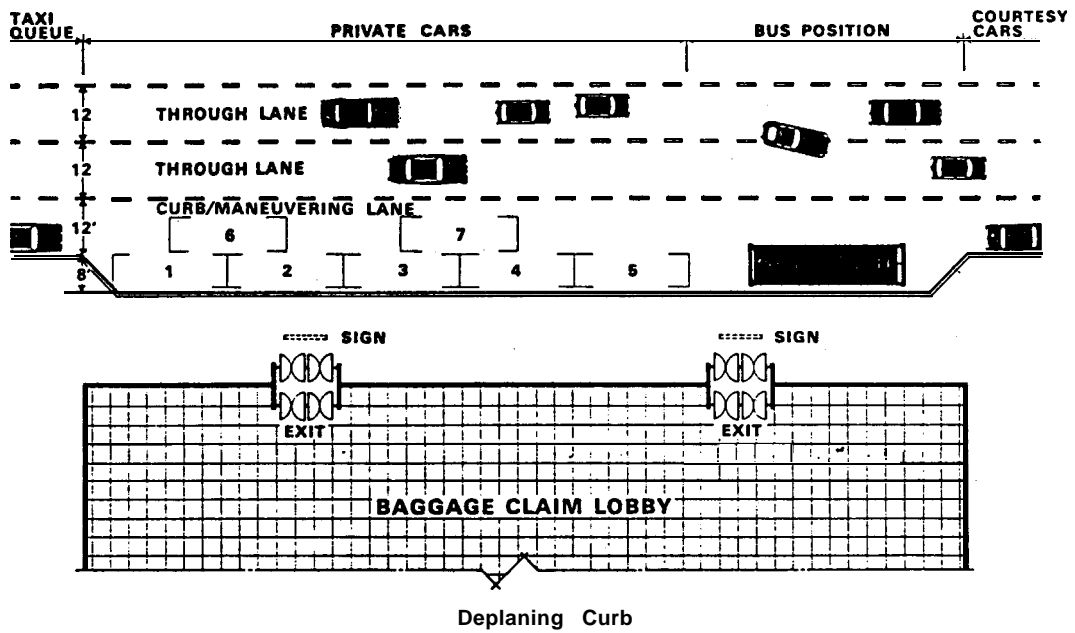
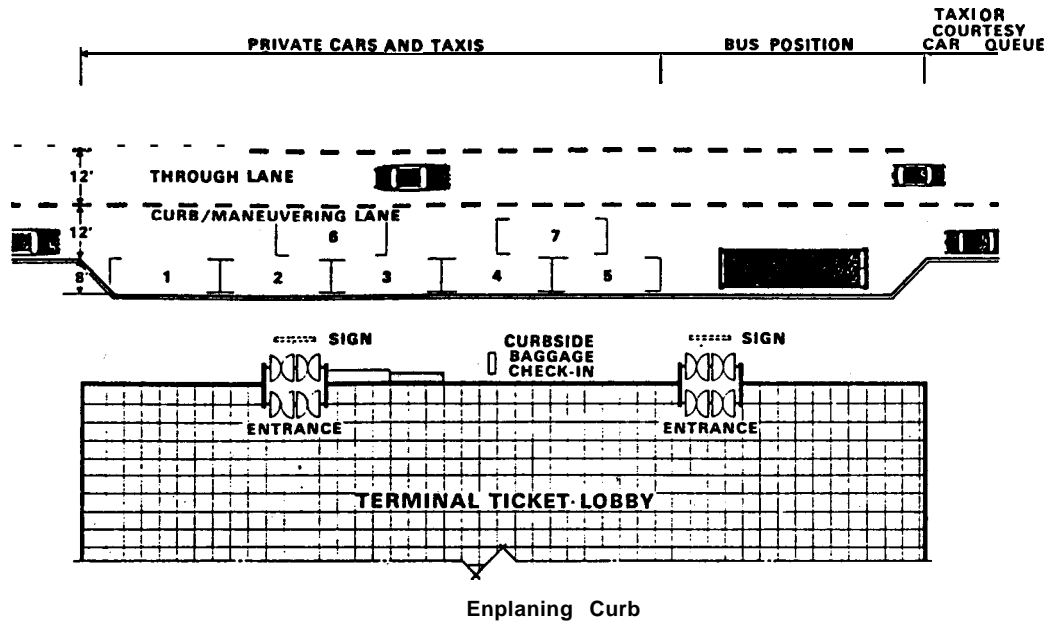

Figure 9-6. Terminal Curb Areas

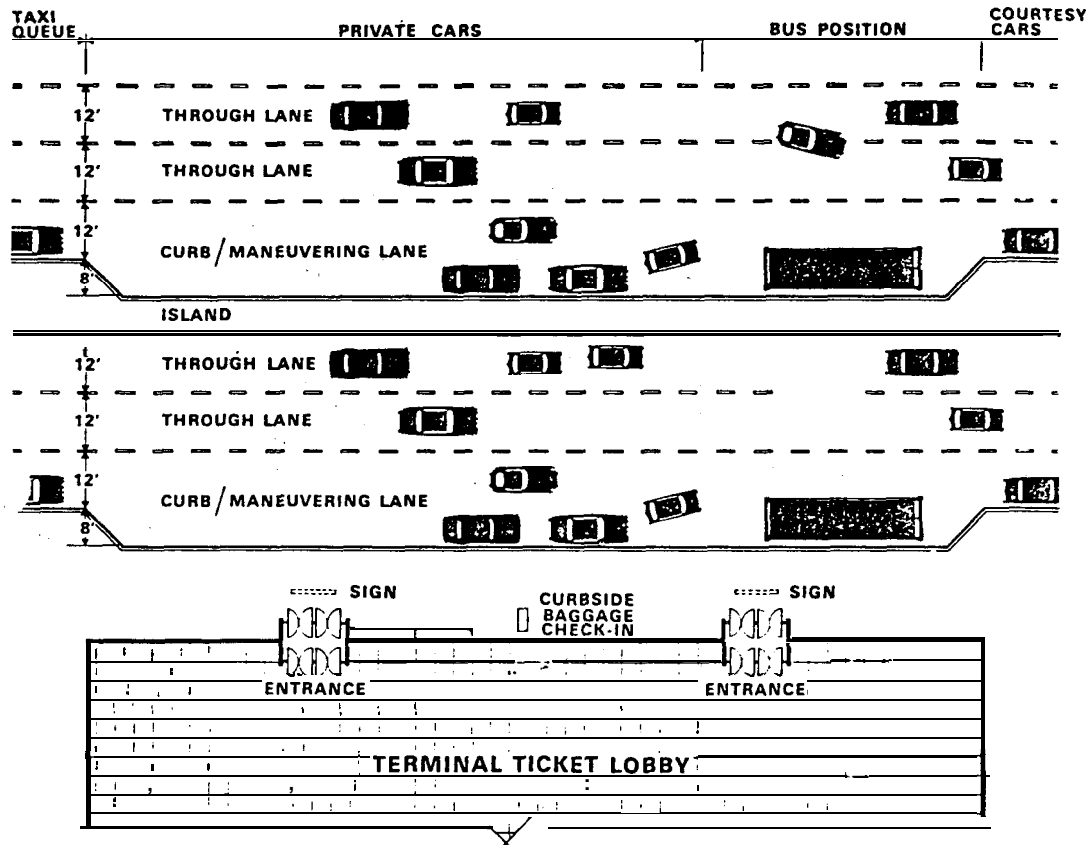

Figure 9-7. Vehicular Island Curb

150. **TERMINAL CURB AREAS.** Curb areas are required at terminals for loading and unloading of passengers and their baggage.

a. **Curbfrontage.** The roadway area adjacent to the curb area is discussed in paragraph 149c. The length of curb to be provided is related to the mix of vehicle types and expected curb dwell time. Table 9-1 shows typical curb dwell times and required vehicle slot lengths for different types of vehicles. It should be noted that, in the case of deplaning passengers, larger volumes of passengers, baggage, and ground transportation requirements peak over shorter periods of time. Strict policing is highly effective in optimizing the vehicle curb slot occupancy rate.

Table 9-j. Typical Curbfrontage Dwell Times and Vehicle Slot Lengths

Vehicle	Curb Dwell Time (Minutes)		Vehicle Slot Length (Feet/Meters)
	Enplane	Deplane	
Private Auto	1.0 to 3.0	2.0 to 4.0	25.0/7.5
Rental Car	1.0 to 3.0	2.0 to 4.0	25.0/7.5
Taxi	1.0 to 2.0	1.0 to 3.0	20.0/6.0
Limousine	2.0 to 4.0	2.0 to 5.0	35.0/10.5
bus	2.0 to 5.0	5.0 to 10.0	50.0/15.0

b. Sidewalk Platforms. Sidewalk platforms are located immediately adjacent to curb/maneuvering lanes and terminal building entrances and exits to provide passenger walkways and safety areas for loading and unloading of vehicles.

(1) At high activity airports, traffic curb islands are often provided to increase the curb area and, in some cases, to segregate different types of ground transportation vehicles. Airports with relatively low passenger levels may be able to accommodate both enplaning and deplaning passengers from one curb face.

(2) Generally, the curb area is divided functionally into enplaning and deplaning curbs. It is separated physically, either horizontally at each end of the terminal building or vertically by means of structural vehicular ramps (see paragraph 36c).

(3) With a one level operation, the deplaning curb is located at the far end of the terminal with respect to approaching vehicular traffic. In the case of vertical separation, deplaning is on the lower level. Such separation minimizes the congestion which will result if opposing flows and volumes of persons, baggage, and ground vehicles are concentrated in the same curb area.

(4) At most terminals, specific curb areas are designated for buses, limousines, courtesy cars, and taxi queues. These designated areas should be located at reasonable distances from terminal exits to reduce congestion. Overhead coverings are desirable to protect disembarking passengers from inclement weather.

c. Curbside Baggage Check-in. Curbside baggage check-in permits baggage to be checked directly to the appropriate airline flight. The area which accommodates this service normally requires space for a baggage check-in desk (usually portable), baggage handtrucks, and a baggage conveyor or belt. Baggage may be either taken by handtruck to the ticket counter or transported directly by an adjacent conveyor belt to the outbound baggage room. The system used is economically related to passenger activity volumes, manpower, and installation cost. Terminal plans should consider design provisions to facilitate both present and future conveyor installations.

d. , Terminal Entryways. Terminal entrances should be located at enplaning curb areas and open directly into airline ticket counter lobbies. Similarly, terminal exits should be located in close proximity to baggage claim facilities and open to deplaning curbs. Automatic doors are highly recommended for: passenger baggage carrying convenience; as a weather buffer; and to increase the efficiency of passenger movement in energy conservation measures.

e. Pedestrian Crossings and Walkways. Pedestrian crossings and walkways from terminal curbs to island platforms and parking facilities should be well marked. At high activity locations, consideration should be given to traffic-controlled crosswalks or, preferably, to grade separation by means of overpasses and tunnels.

151. PUBLIC PARKING FACILITIES. Surveys at some major airports in the United States indicate that from 40 to 85 percent of the originating passengers arrive in private automobiles. Consequently, adequate public parking facilities are essential to good terminal design. Some general guidelines and recommendations for designing these facilities are discussed in succeeding paragraphs.

a. **Locations.** Public parking lots should be located to limit walking distances from parked automobiles to terminals to no more than 1,000 feet (300 m). At larger airports, large volume parking needs may require provision of remote parking facilities served by shuttle bus or people mover systems.

b. **Sizing.** The number of public parking spaces available per million originating passengers varies between airports, particularly at airports with over 1.5 million originations. The range at existing airports may vary from under 1,000 to as high as 3,300 parking spaces per million originations. Another methodology provides parking spaces for 1.5 times the number of peak hour passengers. Figure 9-8, presents a range of parking spaces for 100,000 to 4,000,000 originating passengers at a sample of airports. A better way for estimating parking needs is through a simulation based on existing parking characteristics and forecasted future needs. While simulation is expensive and time consuming, it can be justified where expansion space is severely limited or the cost of additional spaces is very high. A rule-of-thumb suggests an increase of 15 percent in the number of estimated parking spaces to minimize the amount of time required to find a parking space. In developing a parking lot plan, approximately 350 to 400 sq. ft. (31.5 to 36.0 m²), including lanes, should be allowed for each parked automobile. This is the equivalent of 109 to 124 parked cars per acre (269 to 306 per hectare) for on-grade parking.

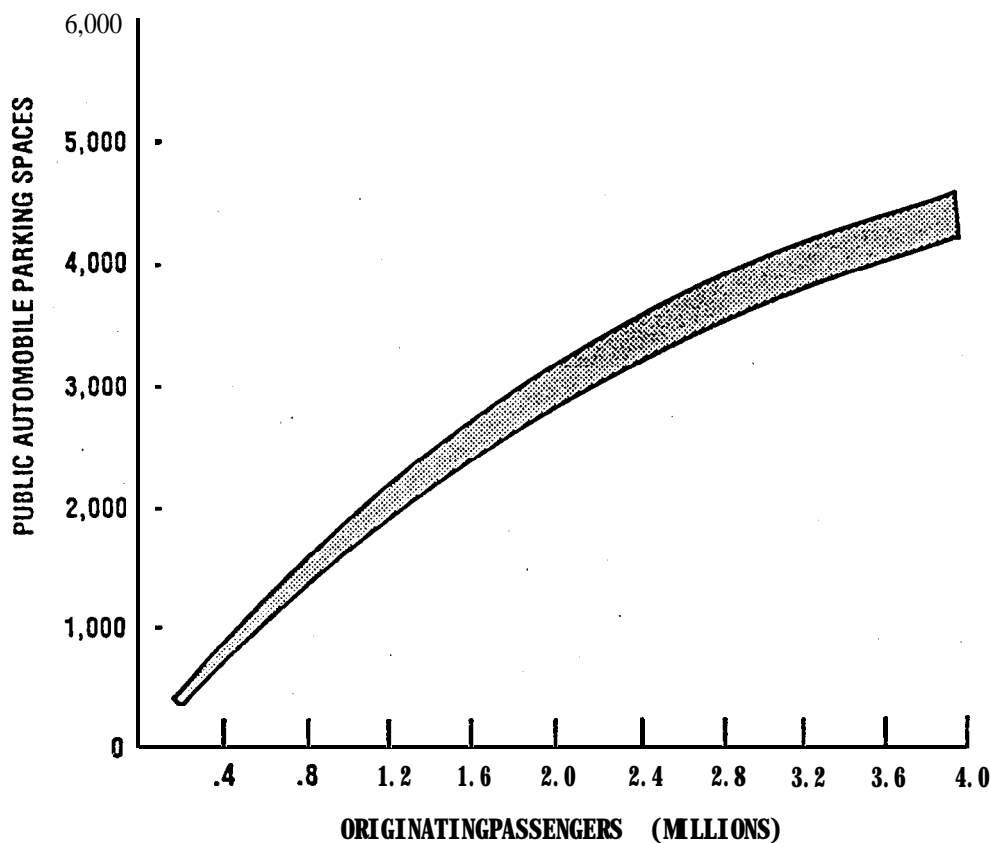

SOURCE: TRB SPECIAL REPORT 215

Figure 9-8. Estimated Requirements for Public Parking at U.S. Airports

c. Short-Term Versus Long-Term Parking. The generally accepted definition for short-term parking is anything less than **three** hours. Approximately 70 to 85 percent of all parking lot users are short-term parkers, mainly greeters and well-wishers. However, this amounts to full time use of only 20 to 30 percent of the total parking requirements. Long-term parkers, the remaining 15 to 30 percent of parking lot users, are almost all travelers and occupy 70 to 80 **percent** of the available parking spaces. Through actual surveys and analysis of parking stubs conducted over several consecutive days, utilization charts can be developed showing vehicle volumes and length of stay. Short-term parking is usually provided nearest the terminal, since its turnover rate is often at **least three** times that of long-term lots. Short-term rates are high to discourage long-term parkers from clogging close in lots. A rule-of-thumb suggests that separate short and long-term parking should be **provided when** the total annual passenger volume exceeds the 150,000 to 200,000 range.

d. Parking Lot Entrances and Exits. Parking lot entrances and exits can easily become points of congestion. This congestion can be **minimized** by providing appropriate ticket dispensing and fee collection facilities and queuing lanes to **reduce vehicle** interference with access roads and parking lot circulation. Entrance and exit points should be **clearly identified** and **sufficiently separated** to avoid confusion. The total in and out airport parking lot flow can approach 25 **percent** of capacity in peak **periods**. **While** automatic ticket dispensers can process up to 400 vehicles **per** hour, a **design** capacity of 240 is recommended. At least two ticket dispensing machines per entrance should be **provided** to **permit** equipment maintenance without severely restricting parking operations. Attendant parking **fee** collection booths can process 120 to 150 vehicles hourly with variable fee parking and about 250 vehicles **per** hour with a flat fee. One collection position should be provided per 105 vehicles hourly in manual mode and one position **per** 185 vehicles per hour in a computerized operation.

e. Circulation. Counter-clockwise circulation within the parking lot is usually preferable and one-way traffic control is recommended to minimize congestion and hazards. Aisle widths should be generous and parking stalls clearly marked. **The** layout should be **designed** to minimize the number of turns and both vehicular and pedestrian travel distances. Parking lot aisles should be laid out in the direction of pedestrian-parker destination. Perpendicular parking is **frequently used**, since it permits parking from each side of the aisle and maximizes the **number** of stalls in a given area. However, parking stall layout mainly depends on **the** area's shape and, to a lesser extent, on local parking habits.

f. Parking Structures. Multilevel parking structures are used at high activity airports, albeit with higher construction costs, to increase the **number** of parking slots in a **given** area and to **reduce** walking distances. This parking arrangement also furnishes users with **protection** from inclement weather.

152. EMPLOYEE AND TENANT PARKING. Surveys show that **approximately** 90 percent of airport employees travel to work in **private** automobiles. **Due** to the variation among airports for aircraft maintenance, air cargo, and **other** servicing activities, a consistent relationship **between** numbers of employees and **passengers** has not been **established**. The number of **employee/tenant** parking spaces should be obtained by surveying airport management and terminal **tenants**. **Employee** and tenant parking should be provided near working areas which are not in or near terminal buildings. Otherwise, remote parking with a shuttle service to work areas is required.

153. PUBLIC TRANSPORTATION AND RENTAL CAR AREAS. Parking facilities are also required for **the** short-term parking of taxis, vans, limousines, **buses**, and for **rental** car ready and storage lots. Discussions should be held with **the** various **service** operators to establish parking **requirements**. Approximately 750 originating passengers are accommodated per rental car ready stall. The space per vehicle **required** for taxi parking and rental car **storage** facilities is less than for public parking or **rental** car ready lots, **since** these vehicles are **driven** by professional drivers. Space for 160 vehicles **per** acre (395 per **hectare**) is recommended. Land in the **immediate** terminal area is at a **premium**. Accordingly, a trend is that on-airport **rental** car agencies are basing vehicles at **remote** locations and using vans to shuttle customers to and from **these** areas. Usually, short-term parking areas for **buses**, taxis, vans, and **limousines** are **located** away from **the** terminal curbfront to increase **curbside** operational efficiency. These vehicles can be **called** to the curb in a **demand** responsive mode and curbfront dwell time considerably reduced. Similarly, provisions can be **made** for exclusive lanes or dedicated auxiliary curbs for high occupancy vehicles such as vans, **limousines**, and **buses**.

154. **ACCESS SYSTEM SIGNS.** Directional and identification signs are extremely important in designing an efficient airport access system. Clearly visible signs should be positioned on roads and in terminal curbs areas well in advance of desired destinations to permit vehicle operations without a need for abrupt movements. Signs should be properly lighted for night use and painted with lettering and background colors which enhance clarity and visibility. Messages should be concise, quickly identifiable, and easily understood. Color coding for unit terminals, airlines, parking facilities, etc., is recommended, particularly for complex terminal areas. The Institute of Transportation Engineers (ITE) Technical Council Committee Report **5D-1, Airport Road Guide Signs (1991)**, may be consulted for further information.

155. TRANSIT SYSTEM LINKS AND AUTOMATED PEOPLE MOVER (APM) SYSTEMS.

a. **Public transit system service** ground access to the **airport, preferably** the airport terminal area, should be considered. High quality public transit service, as provided by rail systems or express bus operations, can attract significant ridership and help alleviate vehicular traffic congestion in the terminal area. Easy direct access to terminal buildings, as well as baggage transport and security, are essential to encourage substantial passenger use.

b. **Automated people mover (APM) systems (automated, driverless vehicles operating on fixed guideways** along an exclusive right-of-way) have demonstrated the potential to be an important element in the airport circulation system. They can serve to provide a convenient and efficient interface for public transit ground access to the airport, as well as means of linking passenger terminals with each other and parking and car rental facilities, hotels, and other airport activity centers. At airports with inside constraints limiting expansion due to high levels of pollution, or a lack of available construction sites, or a lack of adequate transit and highway capacity, APMs can, in some cases, diminish these constraints by skillful arrangement of facilities and reduction of airport vehicular traffic.

156. - 160. RESERVED.

CHAPTER 10. FEDERAL PARTICIPATION IN THE COSTS OF TERMINAL DEVELOPMENT

161. GENERAL. This chapter contains information pertaining to Federal participation in the costs of airport terminal development, including surface access, under the terms of the Airport and Airway Improvement Act of 1982 (P.L. 97- 248), as amended. In particular, the Airport and Airway Safety, Capacity, Noise Improvement, and Intermodal Transportation Act of 1992 has amended the 1982 Act with a focus on international and intermodal issues.

162. BACKGROUND. The 1982 Act (P.L. 97-248), successor to the Airport and Airway Development Act of 1970, provides financial support for necessary improvements to the Nation's airport and airway system. The Act's Airport Improvement Program (AIP) provides **Federal** funds through airport grants to finance improvements to eligible public-use airports in the United States. Section 5 13 of the Act authorizes funds for airport terminal development and establishes requirements and limitations for funding these facilities, including multimodal terminal development.

163. FINANCIAL ASSISTANCE. Airport surface access, multimodal terminals, and other terminal area facilities may be developed with Federal grants-in-aid. Many projects related to the movement of passengers and baggage within the boundaries of the airport may be **AIP** eligible. Passenger Facility Charge (PFC) program funds may be used for AIP-eligible work and certain other projects. Recently, several changes have been made to eligibility by the Congress. Sponsors, consultants, and interested parties should contact FAA Airports offices for current financial assistance and technical guidance with surface access or terminal development.

164. SPECIAL REQUIREMENTS.

a. All safety and security equipment required by rule or regulation is required to be acquired prior to approval of an AIP project for terminal development.

b. Provision of access to the **terminal** building for passengers enplaning or deplaning from aircraft other than air carrier is required (see paragraph 131).

c. *New and existing* terminal buildings and facilities are required to be made accessible to persons with disabilities (see Chapter 7).

165. PRORATION OF TERMINAL BUILDING DEVELOPMENT COSTS. In computing the Federal share for participation, a determination of eligible/ineligible areas is made by the FAA based on engineering judgment and a reasonable review of the areas and facilities dedicated to the movement of passengers **and** baggage. The procedures used in making this determination should be discussed with the FAA Airports **office**.

166. BOND RETIREMENT. Federal grant funds may not ordinarily be used to pay financing costs, such as debt services for bonds issued for airport or terminal development. The only exception is for terminal development financing costs which meet the following criteria:

a. The airport met the definition of an air carrier airport under the previous Airport and Airway Improvement Act;

b. The terminal development was carried out on or **after** July 1, 1970, and before July 12, 1976;

c. The airport sponsor **certifies** that the airport has all the safety and **security** equipment required (see paragraph 131);

d. The Secretary of Transportation **determines** that no project for airport **development** outside the terminal **area** will be **deferred** if such sums are **used** for bond retirement; and

e. It is **agreed** that no funds **available** for airport development will be obligated for any additional terminal development at such airport for a **period** of 3 years **beginning on the** date any such sums are used for bond retirement.

167. APPLICATION OF FEDERAL GUIDANCE. Each **terminal** is a unique facility designed to meet the individual requirements and **desires** of **the** particular community in which it is located. The final design will reflect various demands, constraints, and **compromises**, as **well** as physical and financial limitations. Consequently, it is both impractical and undesirable to **impose** rigid **Federal** standards for determining space and facility requirements for terminal facilities as a condition for receiving **Federal** funds. It is neither the intent or **desire** of the Federal Government to utilize a "cookbook" approach in the **design** of airport terminals or to impose a particular architectural style. Accordingly, **except** for **the** requirements established by legislation or regulation (see paragraph 164), **the** material contained in this advisory circular is presented as general guidance to assist airport sponsors and their consultants in **the** planning and design of airport terminals. It is not intended for use in establishing minimum or maximum limits for determining Federal participation. The final **review** and approval of Federal funds for **terminal** development will consider whether the **design** is reasonable, functional, and not **overly extravagant** or **wasteful**.

168. - 170. RESERVED.

APPENDIX 1 - BIBLIOGRAPHY

1. **Advisory Circulars.** The latest issuance of **free** advisory circulars (AC(s)) may be obtained from the Department of Transportation, General Services **Section**, M-443.2, Washington, D.C. 20590. For sale **ACs** may be ordered from **the Superintendent** of Documents, P.O. Box 371954, Pittsburgh, PA 15250-7954. AC-00-02, Advisory Circular Checklist, lists and contains the **prices** of for sale documents.

- a. 00-2, Advisory Circular Checklist. Contains a listing of all current advisory circulars.
- b. 150/5057-6, Airport Master Plans. Provides guidance for the **preparation** of airport master plans, pursuant to the provisions of **the** Airport and Airway Improvement Act of 1982.
- c. 150/5200-11, Airport Terminals and the Physically Handicapped. Discusses the problems of the physically handicapped air traveler and **suggests** features which can be incorporated into modifications of existing as well as construction of **new** buildings.
- d. 150/5220-21, Guide Specifications for Lifts Used to Board Airline Passengers With Mobility Impairments. Provides subject guidance.
- e. 150/5230-4, Aircraft Fuel Storage, Handling and Dispensing on Airports. Provides information on fuel deliveries to airport storage and **the** handling, cleaning, and dispensing of fuel into aircraft.
- f. 150/5300-13, Airport Design. Presents standards and recommendations for the design of airports.
- g. 150/5360-9, Planning and Design of Airport Terminal Facilities at Non-hub Locations. Provides guidance material for terminal facilities at low activity airports.
- h. 150/5360-11, Energy Conservation for Airport Buildings. Provides guidance on energy conservation in the design and operation of airport buildings.
- i. 150/5360-12, Airport Signing and Graphics. Presents guidance on airport related signs and graphics.
- j. 150/5370-10, Standards for Specifying Construction of Airports. Provides construction standards used to specify grading, drainage, paving, lighting, fencing, and turfing items of work on civil airports.
- k. 70/7460-1, Obstruction Marking and Lighting. Describes FAA standards on obstruction marking and lighting and **establishes** the methods, procedures, and **equipment** types for both aviation red and high intensity white obstruction lights.
- l. 107-1, Aviation Security-Airports. Furnishes guidance to **those** individuals and organizations who have **responsibilities** under FAR Part 107. Provides **recommendations** for establishing and improving security for restricted or critical facilities and **areas** not covered in Part 107.
- m. 108-1, Air Carrier Security. Provides information and guidance on **the** implementation of FAR 108, Airplane Operator Security.
- n. 120-57, Surface Movement Guidance and Control System. Provides guidance on developing a Surface Movement Guidance and Control System (SMGCS) plan.
- o. 129-3, Foreign Air Carrier Security. Provides information and guidance on **the** implementation of sections 129.25, 129.26, and 129.27 of FAR 129.

2. **Government Reports.** Government reports may be obtained from the National Technical Information Service (NTIS), Springfield, Virginia 22151. The number in brackets following the report title represents the NTIS ordering number. The NTIS should be contacted for current costs of each report.

a. FAA-RD-73-82, The Apron-Terminal Complex [AD-771 186].

b. FAA-RD-75-191, The Apron and Terminal Building Planning Report [AD-A018 120].

c. A Study of Airport Design, Art, and Architecture, U.S. Department of Transportation [AD-A099 852].

d. Recommended Security Guidelines for New Airport Construction and Major Renovation [Available from FAA Office of Civil Aviation Security Policy and Planning].

3. **Miscellaneous Reports.**

a. Airports--U.S.A. and Preclearance, Facilities Guidelines for Federal Inspection Services. This document is free and may be ordered from the U.S. Customs Service, 1301 Constitution Avenue, NW., Washington, D.C. 20229.

b. Airline Aircraft Gates and Passenger Terminal Space Approximations. Order from the Air Transport Association of America, 1079 New York Avenue, NW., Washington, D.C. 20006.

c. Airport Terminals Reference Manual. Order from the International Air Transport Association, P.O. Box 550, 2000 Peel Street, Montreal, Quebec, Canada I-13A 2114.

d. American With Disabilities Act Accessibility Guidelines for Buildings and Facilities; Transportation Facilities and Transportation Vehicles (ADMG). Order from the U.S. Architectural and Transportation Barriers Compliance Board, 1331 E Street, N.W., Washington, DC 20004-1111.

e. Special Report 215 - Measuring Airport Landside Capacity. Transportation Research Board, 2101 Constitution Avenue, NW, Washington, D.C. 20418.

f. ITE Technical Council Committee Report SD-1, Airport Roadway Guide Signs (1988) [RR-014A]. Institute of Transportation Engineers, 525 School Street, SW, Washington, DC 20025.

APPENDIX 2—PROJECT PLANNING AND DESIGN

This Appendix provides a suggested questionnaire for consultants and planners preparing for the **construction** of a new passenger terminal or the expansion of an existing building. Because either type of project eventually requires some type of lease and/or rental commitment by building tenants, the sizing of all tenant space (exclusive or joint-use) should be consistent with the requests of prospective tenants. Information on airline tenant space requirements can be obtained from airlines by using this planning data questionnaire. Project planning may also involve situations where it is desirable to review the basic **traffic** flows and functional relationships existing at a number of other comparable passenger terminals.

AIRPORT PROJECT DEVELOPMENT QUESTIONNAIRE**AIRPORT PROJECT DEVELOPMENT QUESTIONNAIRE**

CITY: _____ P R E P A R E D BY: _____
 AIRPORT: _____ AAAC REP: _____
 STATE: _____ AAFC REP: _____
 AAPC REP: _____

This questionnaire is intended to provide individual airline data necessary for planning, design and construction of Apron-Terminal Facilities.

The submission of this questionnaire, and the data contained herein, does not constitute a commitment by the airline/or airlines to support expenditures for acquisition of land or construction of improvements, lease building space or real property, or incur any other commitments.

Facility requirements shown are based on the number of passengers forecasted for that year. However, specific construction programs are normally dictated by economics and their affect upon airport operations. Accordingly, these construction programs are normally based on facility sizing for passenger volumes forecasted during the two to five year period after occupancy. The design year for these construction programs should be mutually agreed upon in advance by the airlines and the Airport Authority.

Section 4 has been added for the purpose of providing basic information on future requirements for support facilities. It is similar to Section 7 of the ATA Airport Master Planning Questionnaire (AD/SC FORM 74-Z).

INSTRUCTIONS:

When completing this questionnaire, fill in all the blanks. If the requested information is not available or not applicable, insert N/A in the appropriate space(s). Do not leave any blank spaces.

SECTION 1 GENERAL PLANNING

EXAMPLE 1 ANEMENTS

	19	1 9	19	19
Annual				
Percent Transfer				
Peak Mnth Is _____				
Average Day - Peak Mnth				
Peak Hour (AD-PM)				
Peak Hour Time of Day				

EXAMPLE 2 ANEMENTS

	19__	19	19	19
Annual				
Percent Transfer				
Peak Mnth Is _____				
Average Day - Peak Month				
Peak Hour (AD-PM)				
Peak Hour Time of Day				

Ratio of Visitors to Passengers: Enplaning Pax _____; Deplaning Pax _____
Ratio of Checked Bags to Passengers: _____

PART 3 GROUND ACCESS INFORMATION

BASED ON _____, 19____

MODE	ENPLANING PASSENGERS			DEPLANING PASSENGERS		
	NO. OF VEHICLES	OCCUPANTS PER VEHICLE	% PAX USING MODE	NO. OF VEHICLES	OCCUPANTS PER VEHICLE	% PAX USING MODE
Private Auto (Air Pax. Only)						
Serve-Private Auto*						
Rental Car						
Taxi						
Bus						
Other						

* Serve-Private Auto = Trip purpose of seeing, meeting, dropping off, picking up, greeting or well-wishing an air passenger.

	ENPLANING PASSENGERS		DEPLANING PASSENGERS	
	NO. OF VEHICLES	PERCENTAGE	NO. OF VEHICLES	PERCENTAGE
Private autos using only the curb				
Private autos using curb before going to parking facility				

% of Private Autos Using Parking Facility _____%

Maximum Vehicle Storage Accumulation in the Parking Facility _____ Vehicles

NOTE:

- a) This information for Section 1 is generally required to determine the elements of the Apron-Terminal which are or may be in common use, such as public corridors, terminal lobby and public waiting areas, baggage claim, vehicle curb length and parking facilities.
- b) Most of the data on vehicular traffic can only be obtained through the Airport Authority. Surveys may be required in the absence of any updated information.

**PART 2 INDIVIDUAL DEPARTURE LOUNGE
SIZING PER AIRCRAFT GATE**

	19 _____		-19_ -		19 _____		19 _____	
Lounge No.	Gate Capability - Specify range of aircraft size	Area in Sq. Ft.	Gate Capability - Specify range of aircraft size	Area in Sq. Ft.	Gate Capability - Specify range of aircraft size	Area in Sq. Ft.	Gate Capability - Specify range of aircraft size	Area in Sq. Ft.

4/22/88

PART 3 SECURITY

INDICATE REQUIREMENTS OR RECOMMENDATIONS FOR SECURITY

Suggested Locations:	
Recommended Type of Equipment (Manual, X-Ray, or other)	

PART 4 COMMUNICATIONS AND FLIGHT INFORMATION

		YES	NO	COMMENTS
Public Address System				
Flight Information (Describe type under comments)				
Signs	Roadway			
	Terminal			
	Gates			

PART 5 DESIGN DAY - ACTIVITY TABLE

NOTE:

- a) This information can be given for one term (five year forecast period). However, the selected period of time is to be agreed upon jointly by the Airline Airport Planning Committee.
- b) Design Day is defined as the Average Day of the Peak Mnth.
- c) Complete the Table for a minimum of 18 hours of activity.

FORECAST YEAR

PEAK MONTH

ARRIVAL TIME	PASSENGERS OFF	AIRCRAFT TYPE	PASSENGERS ON	DEPARTURE TIME

PART 6 AIRLINE TERMINAL TICKET OFFICE

a) TICKET COUNTER

		19	19	19	19	LOCATION
Type (Specify Linear vs. Through)						
Ticket Counter Length		lf	lf	lf	lf	
Number of Positions	Ticket Counter in Terminal					
	Curbside Baggage. Check-In					
Modular Length per Position in Terminal		lf	lf	lf	lf	

b) BACK OFFICES (behind ticket counter)

Supervisory Office(s)		sf	sf	sf	sf
Other Offices		sf	sf	sf	sf
Check-out Area	Area	sf	sf	sf	sf
	No. of People				
Wrk Space		sf	sf	sf	sf
Locker/Lounge Area		sf	sf	sf	sf

PART 7 TICKET LIFT SUPPORT FACILITY

Specify: Required in Terminal _____ Required in Connector (Specify 2nd vs. Ground Level) _____

	19	19	19	19	LOCATION
Flight Close-out Room	sf	sf	sf	sf	
Check-out Room	sf	sf	sf	sf	
No. of People Checking out Simltaneously					
Storage	sf	sf	sf	sf	
Supervisory Offices	sf	sf	sf	sf	
Lounge	sf	sf	sf	sf	
Locker Room	sf	sf	sf	sf	
Training Room	sf	sf	sf	sf	
Other (Specify):	sf	sf	sf	sf	
TOTAL AREA	sf	s f	sf	sf	

PART 8 PASSENGER SERVICE MANAGER

	19	19	19	19	LOCATION
	_____		_____	_____	

PART 10 BOUND BAGGAGE ROOM

		19 _____	19 _____	19 _____	19 _____	LOCATION
Type (Specify <u>Shared</u> vs. <u>Exclusive</u>)						
Clear Height		ft.	ft.	ft.	ft.	
Clear Length		ft.	ft.	ft.	ft.	
Clear Width		ft.	ft.	ft.	ft.	
Sort Device(s)	Available from One Side	lf.	lf.	lf.	lf.	
	Available from Both Sides	lf.	lf.	lf.	lf.	
Special* (Skis, Oversize Parcels, etc.)		sf.	sf.	sf.	sf.	

PART 11 INBOUND BAGGAGE

		19 _____	19 _____	19 _____	19 _____	LOCATION
Baggage Unloading	Width	ft.	ft.	ft.	ft.	
	length	ft.	ft.	ft.	ft.	
Claim Device(s) (Passenger Retrieval)	Device #1	lf.	lf.	lf.	lf.	
	Device #2	lf.	lf.	lf.	lf.	
	Device #3	lf.	lf.	lf.	lf.	

ITEMS E L L A N E O U S

		19 ____	19 ____	19 ____	19 ____	LOCATION
Mail and Express Transfer Areas		sf.	sf.	sf.	sf.	
Skycaps Room		sf.	sf.	sf.	sf.	
Other (Specify):		sf.	sf.	sf.	sf.	
		sf.	sf.	sf.	sf.	

		19 ____	19 ____	19 ____	19 ____	LOCATION
Flight Info. Center/Load and Clearance		sf.	sf.	sf.	sf.	
Communications/Teletype Area		sf.	sf.	sf.	sf.	
Telephone Equipment Rooms		sf.	sf.	sf.	sf.	
Flight Plan Area(No. of positions@ 3 ft.)						
Weather Display		sf.	sf.	sf.	sf.	
Operations Crew Area		sf.	sf.	sf.	sf.	

4/22/88

AIRLINE OPERATIONS (CONT'D)

Stewardess Administration	sf	sf	sf	sf
Training Room	sf	sf	sf	sf
Food Bank/Top-off Area	sf	sf	sf	sf
Other (Specify):	sf	sf	sf	sf

PART 14 LINE CARGO FACILITIES

	19 _____	19 _____	19 _____	19 _____	LOCATION
Storage	sf	sf	sf	sf	
Supervisory Offices	sf	sf	sf	sf	
Ready Room	sf	sf	sf	sf	
Locker Rooms	sf	sf	sf	sf	
Lunch Rooms	sf	sf	sf	sf	
Clerical	sf	sf	sf	sf	
Training	sf	sf	sf	sf	
Other (Specify):	sf	sf	sf	sf	

PART 16 FACILITIES MAINTENANCE

	19 ____	19 ____	19 ____	19 ____	LOCATION
Shop	sf	sf	sf	sf	
Storage	sf	sf	sf	sf	
Other (Specify):					

PART 17 AIRCRAFT LINE MAINTENANCE SUPPORT AREA

	19 ____	19 ____	19 ____	19 ____	LOCATION
Stores and Tools	sf	sf	sf	sf	
Technical Services	sf	sf	sf	sf	
Production Offices	sf	sf	sf	sf	I
Satellite Shops	sf	sf	sf	sf	
Wheel Storage Area	sf	sf	sf	sf	
Fluids Area	sf	sf	sf	sf	
Supervisory Offices	sf	sf	sf	sf	
Other (Specify):	sf	sf	sf	sf	

PART 18 ADMINISTRATION

	19	19	19	19	LOCATION
City Manager's Office	sf	sf	sf	sf	
Secretarial	sf	sf	sf	sf	
Personnel Management	sf	sf	sf	sf	
Secretarial	sf	sf	sf	s f	
Controller including secretarial	sf	sf	sf	sf	
Offices	sf	s f	sf	sf	
Conference Room	sf	sf	sf	sf	
Miscellaneous	sf	'sf	sf	sf	
Areas (Specify)	sf	sf	sf	sf	

PART 19 EMPLOYEE CAFETERIA

	19	19	19	19	LOCATION
Total Area (Joint Use)	s	f sf	sf	sf	

SECTION 3 APRON

FIXED APRON FACILITIES

	NO	YES	COMMENTS
Guide-In System			
Potable Water			
Electrical Power for Aircraft			Type:
Ground Rods			
Hydrant Fueling			
Aircraft Sewage Disposal Facility			
Ramp Lighting			
Ground Equipment Parking Off-Gate			
Aircraft Parking	No. of positions at terminal; Specify Aircraft Size:		
	No. of positions Off-gate _____; Specify Aircraft Size:		
	Overnight parking positions in addition to above _____; Specify Aircraft Size:		

SECTION 4 REMOTE 'SUPPORT FACILITIES (Total Area)

19	19	19	19	LOCATION
----	----	----	----	-----------------

APPENDIX 3 - FEDERAL INSPECTION SERVICES APPROVAL OFFICES

The following is a listing of addresses **and** phone numbers of the national headquarters offices of the Federal Inspection Services (FIS).

- o Commissioner of Customs, U.S. Customs Service
1301 Constitution Avenue, N.W.
Washington, D.C. 20229
Attn: Director, Passenger Enforcement and Facilitation
Telephone No.: 202-566-5607

- o Associate Commissioner, Management
Immigration and Naturalization **Service**
425 I Street, N.W.
Washington, D.C. 20536
Attn: Chief, Facilities and Engineering Branch
Telephone No.: 202-633-3110

- o Plant Protection and Quarantine
Animal and Plant Health Inspection Service
6505 Belcrest Road, Room 635, Federal Building
Hyattsville, Maryland 20782
Attn: Chief, Port Operations
Telephone No.: 301-436-8295

- o Director, Division of Quarantine
Public Health Service
Center for Prevention Services
Centers for Disease Control
Atlanta, Georgia 30333
Attn: Chief, Programs Operation Branch
Telephone No.: 404-639-1437

- o U.S. Fish' and Wildlife Service
Division of Law Enforcement
4401 N. Fairfax Drive, Room 500
Arlington, Virginia 22203
Attn: Desk Officer for International Trade
Telephone No.: 703-358-1949