



**PDHonline Course C465 (4 PDH)**

---

## **Concrete Pavement Preservation**

*Instructor: John Huang, Ph.D., PE and John Poullain, PE*

**2020**

**PDH Online | PDH Center**

5272 Meadow Estates Drive  
Fairfax, VA 22030-6658  
Phone: 703-988-0088  
[www.PDHonline.com](http://www.PDHonline.com)

An Approved Continuing Education Provider



# MAINTENANCE TECHNICAL ADVISORY GUIDE

## Volume II - Rigid Pavement Preservation

### Second Edition



### **State of California Department of Transportation**

Office of Pavement Preservation  
Division of Maintenance  
1120 N Street, MS-5  
Sacramento, CA 95814

March 7, 2008

## TABLE OF CONTENTS

<b>CHAPTER 1 INTRODUCTION .....</b>	<b>1-1</b>
<b>1.1 PURPOSE OF PAVEMENT PRESERVATION .....</b>	<b>1-1</b>
1.1.1 Definition.....	1-1
1.1.2 Pavement Preservation Concept .....	1-1
1.1.3 Benefits of Pavement Preservation.....	1-2
1.1.4 Treatment Selection and the Optimum Timing for the Treatment.....	1-2
<b>1.2 PCC PAVEMENT DESIGN AND PERFORMANCE IN CALIFORNIA .....</b>	<b>1-3</b>
1.2.1 Design and Performance.....	1-3
1.2.2 Causes of Rigid Pavement Deterioration .....	1-5
1.2.3 Faulting Mechanism and Effort on Addressing Faulting.....	1-5
<b>1.3 COMMON PCC PAVEMENT DISTRESS TYPES.....</b>	<b>1-6</b>
1.3.1 Joint Deficiencies and Cracking .....	1-7
1.3.2 Surface Defects.....	1-11
1.3.3 Other Miscellaneous Distresses .....	1-12
1.3.4 Summary.....	1-15
<b>1.4 MATERIALS CONSIDERATIONS .....</b>	<b>1-17</b>
1.4.1 Concrete Constituent Materials .....	1-18
1.4.2 Cementitious Repair Materials.....	1-20
1.4.3 Specialty Repair Materials .....	1-20
1.4.4 Bituminous Materials .....	1-20
1.4.5 Joint Sealants.....	1-20
1.4.6 Dowel Bars and Tie Bars .....	1-21
<b>1.5 DESIGN CONSIDERATIONS .....</b>	<b>1-21</b>
1.5.1 Traffic .....	1-21
1.5.2 Environment .....	1-21
1.5.3 Windows of Opportunities .....	1-22
1.5.4 Traffic Control.....	1-23
1.5.5 Item Codes.....	1-23
<b>1.6 KEY REFERENCES .....</b>	<b>1-23</b>
<b>CHAPTER 2 SURFACE CHARACTERISTICS .....</b>	<b>2-1</b>
<b>2.1 IMPORTANT SURFACE CHARACTERISTICS .....</b>	<b>2-1</b>
<b>2.2 RIDE QUALITY.....</b>	<b>2-1</b>
2.2.1 Definitions .....	2-2
2.2.2 Measuring Smoothness.....	2-2
<b>2.3 TEXTURE .....</b>	<b>2-7</b>
2.3.1 Definitions of Surface Texture.....	2-8

2.3.2 Techniques to Create Texture.....	2-10
2.3.3 Measurement of Surface Texture.....	2-12
2.3.4 Summary.....	2-15
<b>2.4 SURFACE FRICTION.....</b>	<b>2-15</b>
2.4.1 Background.....	2-15
2.4.2 Factors that Affect Pavement Friction.....	2-16
2.4.3 Measurement of Pavement Friction.....	2-18
2.4.4 Current Surface Friction Criteria and Measurement Practices.....	2-24
2.4.5 Summary.....	2-25
<b>2.5 NOISE.....</b>	<b>2-26</b>
<b>2.6 ACHIEVING DESIRED SURFACE CHARACTERISTICS.....</b>	<b>2-26</b>
2.6.1 Ride.....	2-26
2.6.2 Texture and Friction.....	2-27
2.6.3 Noise.....	2-27
<b>2.7 KEY REFERENCES.....</b>	<b>2-27</b>
<b>CHAPTER 3 FRAMEWORK FOR TREATMENT SELECTION.....</b>	<b>3-1</b>
<b>3.1 FACTORS TO CONSIDER.....</b>	<b>3-1</b>
3.1.1 Ride.....	3-1
3.1.2 Skid.....	3-1
3.1.3 Noise.....	3-1
3.1.4 Distress Type.....	3-2
3.1.5 Durability/Longevity.....	3-2
<b>3.2 SELECTION PROCESS.....</b>	<b>3-2</b>
<b>3.3 ASSESS THE EXISTING PAVEMENT CONDITIONS.....</b>	<b>3-2</b>
3.3.1 Project Information Review.....	3-3
3.3.2 Field Distress Survey.....	3-4
3.3.3 Field Sampling and Testing of Existing Pavement.....	3-4
3.3.4 Performance Requirements.....	3-5
<b>3.4 DETERMINE THE FEASIBLE TREATMENT OPTIONS.....</b>	<b>3-6</b>
<b>3.5 COMPARE THE FEASIBLE OPTIONS.....</b>	<b>3-9</b>
3.5.1 Life Cycle Costing.....	3-9
3.5.2 Compare and Select Options.....	3-10
<b>3.6 KEY REFERENCES.....</b>	<b>3-11</b>
<b>CHAPTER 4 JOINT RESEALING AND CRACK SEALING.....</b>	<b>4-1</b>
<b>4.1 PURPOSE AND DESCRIPTION OF TREATMENT.....</b>	<b>4-1</b>
<b>4.2 MATERIALS AND SPECIFICATIONS.....</b>	<b>4-2</b>

4.2.1 Sealant Properties .....	4-2
4.2.2 Sealant Types and Specifications .....	4-3
<b>4.3 PROJECT SELECTION .....</b>	<b>4-5</b>
<b>4.4 DESIGN CONSIDERATIONS .....</b>	<b>4-5</b>
4.4.1 Material Selection .....	4-5
4.4.2 Joint Resealing .....	4-6
4.4.3 Filling .....	4-7
4.4.4 Special Considerations.....	4-7
4.4.5 Reservoir Design for Joint Resealing.....	4-8
4.4.6 Special Considerations for Cracks.....	4-11
4.4.7 Typical Item Codes .....	4-12
<b>4.5 CONSTRUCTION PROCESS .....</b>	<b>4-12</b>
4.5.1 Traffic Control and Safety.....	4-13
4.5.2 Equipment.....	4-13
4.5.3 Remove Old Sealant .....	4-14
4.5.4 Shape Reservoir / Reface Joint.....	4-14
4.5.5 Clean Joint Reservoir.....	4-14
4.5.6 Install Backer Rod.....	4-15
4.5.7 Install Sealant.....	4-15
4.5.8 Crack Sealing .....	4-17
4.5.9 Trafficking .....	4-17
4.5.10 Quality.....	4-18
<b>4.6 SUMMARY .....</b>	<b>4-20</b>
<b>4.7 PROJECT CHECKLIST AND TROUBLESHOOTING GUIDE .....</b>	<b>4-20</b>
4.7.1 Project Checklist .....	4-20
4.7.2 Troubleshooting Guide.....	4-23
<b>4.8 KEY REFERENCES .....</b>	<b>4-25</b>
<b>CHAPTER 5 DIAMOND GRINDING AND GROOVING .....</b>	<b>5-1</b>
<b>5.1 DESCRIPTION OF TREATMENT .....</b>	<b>5-1</b>
5.1.1 Overview.....	5-1
5.1.2 Purpose.....	5-2
5.1.3 Advantages .....	5-3
5.1.4 Limitations.....	5-4
<b>5.2 DESIGN AND SPECIFICATION.....</b>	<b>5-4</b>
5.2.1 Terminology.....	5-4
5.2.2 Design Parameters .....	5-5
5.2.3 Specifications.....	5-5

5.2.4 Typical Item Codes .....	5-6
<b>5.3 PROJECT SELECTION .....</b>	<b>5-7</b>
5.3.1 Applications .....	5-7
5.3.2 Project Evaluation .....	5-9
5.3.3 Expected Lives of Treatments .....	5-11
<b>5.4 CONSTRUCTION PROCESS .....</b>	<b>5-12</b>
5.4.1 Traffic Control and Safety .....	5-12
5.4.2 Equipment .....	5-13
5.4.3 Productivity .....	5-17
5.4.4 Slurry Removal .....	5-17
5.4.5 Sequencing Work .....	5-17
5.4.6 Job Review - Quality Issues .....	5-18
<b>5.5 PROJECT CHECKLIST AND TROUBLESHOOTING GUIDE .....</b>	<b>5-19</b>
5.5.1 Project Checklist .....	5-19
5.5.2 Troubleshooting Guide .....	5-21
<b>5.6 KEY REFERENCES .....</b>	<b>5-23</b>
<b>CHAPTER 6 DOWEL BAR RETROFIT .....</b>	<b>6-1</b>
<b>6.1 BACKGROUND.....</b>	<b>6-1</b>
6.1.1 Load Transfer Efficiency .....	6-1
6.1.2 Measuring Load Transfer Efficiency .....	6-2
<b>6.2 PURPOSE AND DESCRIPTION OF TREATMENT .....</b>	<b>6-2</b>
<b>6.3 PROJECT SELECTION .....</b>	<b>6-3</b>
6.3.1 Factors to Consider .....	6-3
6.3.2 Expected Performance .....	6-4
<b>6.4 DESIGN AND MATERIAL CONSIDERATIONS.....</b>	<b>6-5</b>
6.4.1 Load Transfer Devices .....	6-5
6.4.2 Dowel Bar Specification .....	6-5
6.4.3 Dowel Bar Layout .....	6-7
6.4.4 Backfill Material .....	6-8
6.4.5 Design of Slot-Dowel-Chair System .....	6-9
6.4.6 Typical Item Codes .....	6-10
<b>6.5 CONSTRUCTION PROCESS .....</b>	<b>6-11</b>
6.5.1 Traffic Control and Safety .....	6-11
6.5.2 Dowel Bar Retrofit Process .....	6-11
6.5.3 Cutting Sides of Slot .....	6-12
6.5.4 Remove Concrete from Slot .....	6-14
6.5.5 Seal Joint or Crack .....	6-15

6.5.6 Placing Dowel Bars.....	6-16
6.5.7 Backfilling.....	6-17
6.5.8 Opening to Traffic .....	6-19
6.5.9 Diamond Grinding.....	6-19
6.5.10 Joint Sealing .....	6-19
6.5.11 Job Review-Quality Control.....	6-19
<b>6.6 PROJECT CHECKLIST AND TROUBLESHOOTING GUIDE .....</b>	<b>6-22</b>
6.6.1 Factors to Consider.....	6-22
6.6.2 Project Checklist .....	6-22
6.6.3 Troubleshooting Guide.....	6-25
<b>6.7 KEY REFERENCES .....</b>	<b>6-27</b>
<b>CHAPTER 7 ISOLATED PARTIAL DEPTH CONCRETE REPAIR.....</b>	<b>7-1</b>
<b>7.1 PURPOSE AND DESCRIPTION OF TREATMENT .....</b>	<b>7-1</b>
7.1.1 Partial Depth Repair .....	7-1
<b>7.2 MATERIALS AND SPECIFICATIONS.....</b>	<b>7-1</b>
7.2.1 Materials Selection.....	7-2
7.2.2 Cementitious Materials .....	7-2
7.2.3 Specialty Materials.....	7-4
7.2.4 Bituminous Materials .....	7-5
7.2.5 Bonding Agents.....	7-5
<b>7.3 ENGINEERING CONSIDERATIONS.....</b>	<b>7-6</b>
7.3.1 Project Selection.....	7-6
7.3.2 Concurrent Work.....	7-6
7.3.3 Repair Locations and Boundaries.....	7-6
7.3.4 Typical Item Codes .....	7-7
<b>7.4 CONSTRUCTION PROCESS .....</b>	<b>7-8</b>
7.4.1 Traffic Control and Safety .....	7-8
7.4.2 Equipment.....	7-8
7.4.3 Repair Locations .....	7-8
7.4.4 Concrete Sawing and Removal.....	7-9
7.4.5 Cleaning and Repair Area Preparation .....	7-11
7.4.6 Joint Preparation.....	7-12
7.4.7 Materials Placement.....	7-13
7.4.8 Finishing.....	7-13
7.4.9 Curing.....	7-13
7.4.10 Joint Sealing .....	7-14
7.4.11 Opening to Traffic .....	7-14

7.4.12 Job Review-Quality Issues.....	7-14
<b>7.5 PROJECT CHECKLIST AND TROUBLESHOOTING GUIDE .....</b>	<b>7-15</b>
7.5.1 Project Checklist .....	7-15
7.5.2 Troubleshooting Guides .....	7-18
<b>7.6 KEY REFERENCES .....</b>	<b>7-18</b>
<b>CHAPTER 8 FULL DEPTH CONCRETE REPAIR .....</b>	<b>8-1</b>
<b>8.1 PURPOSE AND DESCRIPTION OF TREATMENT .....</b>	<b>8-1</b>
8.1.1 Full Depth Repair.....	8-1
<b>8.2 MATERIALS AND SPECIFICATIONS.....</b>	<b>8-1</b>
8.2.1 Materials Selection.....	8-1
8.2.2 Cementitious Materials .....	8-2
8.2.3 Bituminous Materials .....	8-3
<b>8.3 ENGINEERING CONSIDERATIONS.....</b>	<b>8-3</b>
8.3.1 Project Selection.....	8-3
8.3.2 Concurrent Work.....	8-4
8.3.3 Repair Locations and Boundaries .....	8-4
8.3.4 Load Transfer Devices .....	8-5
8.3.5 Typical Item Codes .....	8-6
<b>8.4 CONSTRUCTION PROCESS .....</b>	<b>8-7</b>
8.4.1 Traffic Control and Safety .....	8-7
8.4.2 Equipment.....	8-7
8.4.3 Repair Locations .....	8-7
8.4.4 Concrete Sawing and Removal.....	8-8
8.4.5 Cleaning and Repair Area Preparation .....	8-9
8.4.6 Provision of Load Transfer .....	8-10
8.4.7 Joint Preparation.....	8-11
8.4.8 Bond Breaker.....	8-12
8.4.9 Materials Placement.....	8-12
8.4.10 Finishing.....	8-12
8.4.11 Curing.....	8-13
8.4.12 Joint Sealing .....	8-13
8.4.13 Opening to Traffic .....	8-13
8.4.14 Job Review-Quality Issues.....	8-14
<b>8.5 PROJECT CHECKLIST AND TROUBLESHOOTING GUIDE .....</b>	<b>8-14</b>
8.5.1 Project Checklist .....	8-14
8.5.2 Troubleshooting Guides .....	8-17
<b>8.6 KEY REFERENCES .....</b>	<b>8-19</b>



**APPENDIX A – PAVEMENT PRESERVATION DEFINITIONS**

**APPENDIX B – GLOSSARY OF TERMS**

**APPENDIX C – LIST OF ACRONYMS**

**APPENDIX D – USEFUL WEBSITES**

**APPENDIX E – CALTRANS SURFACE TREATMENT REVIEW  
CHECKLIST AND EVALUATION**

## LIST OF FIGURES

Figure 1-1 Typical pavement performance curve and maintenance/rehabilitation time .....	1-2
Figure 1-2 Concept of optimal timing for pavement preservation (Galehouse et al, 2003) .....	1-3
Figure 1-3 Slab drop-off caused by base erosion (Stahl, 2006) .....	1-6
Figure 1-4 Spalling at the joint (Caltrans, 2004a) .....	1-7
Figure 1-5 Faulting (FHWA, 2003) .....	1-8
Figure 1-6 Example of joint seal damage (FHWA, 2003) .....	1-8
Figure 1-7 Examples of longitudinal joint crack (FHWA, 2003).....	1-9
Figure 1-8 Transverse cracking (FHWA, 2003).....	1-9
Figure 1-9 Examples of cracks at different stages (Caltrans, 2004a).....	1-10
Figure 1-10 Corner break/cracking (Caltrans, 2004a).....	1-10
Figure 1-11 D-Cracking (Caltrans, 2004b) .....	1-11
Figure 1-12 Map-cracking (FHWA, 2003) .....	1-11
Figure 1-13 Example of scaling (FHWA, 2003) .....	1-11
Figure 1-14 Example of surface polish/polished aggregate (FHWA, 2003).....	1-12
Figure 1-15 Severe surface abrasion with third stage cracking (Caltrans, 2004b).....	1-12
Figure 1-16 Example of popouts (FHWA, 2003).....	1-12
Figure 1-17 Example of blow-ups (FHWA, 2003) .....	1-13
Figure 1-18 Examples of pumping and water bleeding (Caltrans, 2004a).....	1-13
Figure 1-19 Lane/shoulder drop-off (FHWA, 2003).....	1-14
Figure 1-20 Settlement (Caltrans, 2004b).....	1-14
Figure 2-1 Profilographs for measuring roughness (Budras, 2001) .....	2-3
Figure 2-2 Response-Type Road Roughness Measuring System - Mays Meter (Budras, 2001) .....	2-4
Figure 2-3 Road Roughness Profiling Devices (Budras, 2001) .....	2-5
Figure 2-4 Non-Contact Lightweight Profiling Devices (Budras, 2001) .....	2-6
Figure 2-5 Multi-laser Profiler Vehicle (Budras, 2001).....	2-7
Figure 2-6 ROSAN System (Budras, 2001).....	2-7
Figure 2-7 Illustration of PIARC pavement surface characteristic classifications and their impact on pavement performance measures (ACPA, 2006a) .....	2-8
Figure 2-8 Differences between Macrotexture and Microtexture (Shahin, 1994).....	2-9
Figure 2-9 Photo of original “sand patch” test using Ottawa sand and spreading tool .....	2-12
Figure 2-10 Photo of volumetric texture depth (“sand patch”) test equipment with glass beads and hockey puck (Wambold and Henry, 2002).....	2-13
Figure 2-11 Photo of Circular Texture Meter (CTMeter) (Abe et. al, 2001) .....	2-14
Figure 2-12 Photo of outflow meter in use (Wambold and Henry, 2002).....	2-14
Figure 2-13 Pennsylvania DOT E-274 locked-wheel friction tester (Wambold and Henry, 2002) ...	2-18
Figure 2-14 Photo of Mu Meter (Wambold and Henry, 2002) .....	2-20
Figure 2-15 Photo of SCRIM (Wambold and Henry, 2002).....	2-20
Figure 2-16 Photo of GRIPTESTER-towed mode (Wambold and Henry, 2002).....	2-21
Figure 2-17 Photo of SAAB Surface Friction Tester (Wambold and Henry, 2002) .....	2-21
Figure 2-18 Photo of Norsometer ROAR-Variable Friction Tester (Wambold and Henry, 2002) ....	2-22
Figure 2-19 Photo of British Pendulum Tester (Wambold and Henry, 2002) .....	2-23
Figure 2-20 Photo of Dynamic Friction Tester (courtesy of Nippou Sango Co, Ltd) .....	2-23
Figure 4-1 Illustration of sealant shape factor (FHWA, 2004).....	4-9
Figure 4-2 Joint sealant configurations (FHWA, 2004) .....	4-10
Figure 4-3 A typical five cell seal cross-section (ACPA, 1993) .....	4-11

Figure 5-1 Concrete pavement surface after diamond grinding .....	5-1
Figure 5-2 Concrete pavement surface after diamond grooving. ....	5-2
Figure 5-3 Faulting at a joint (FHWA, 2006).....	5-2
Figure 5-4 Diamond grinding and grooving terminology (FHWA, 2005).....	5-4
Figure 5-5 Faulting mechanism.....	5-8
Figure 5-6 Reliability levels for the expected survivability of California diamond ground pavements (Caltrans, 2005).....	5-12
Figure 5-7 Schematic of grinding machine (MnDOT, 2005).....	5-13
Figure 5-8 Typical grinding machine, front view (Courtesy of Caltrans).....	5-14
Figure 5-9 Grinding process (Courtesy of Caltrans).....	5-14
Figure 5-10 Diamond blades (Courtesy of Caltrans) .....	5-15
Figure 5-11 Typical cutting head (Courtesy of Caltrans).....	5-15
Figure 5-12 Pavement surface after diamond grinding (Courtesy of IGGA).....	5-16
Figure 5-13 Pavement surface texture behind grinding head (Courtesy of Caltrans) .....	5-16
Figure 5-14 Sequence of repairs in the concrete pavement restoration process (FHWA, 2005) .....	5-18
Figure 6-1 Load transfer (Caltrans, 2006a) .....	6-2
Figure 6-2 Photo of dowels with chair, end caps, and foam core insert in place (Caltrans, 2006a).....	6-6
Figure 6-3 Dowel layout figure (Caltrans, 2005) .....	6-7
Figure 6-4 Dowel/Slot layout (Caltrans, 2005) .....	6-10
Figure 6-5 Schematics of the construction process (FHWA/ACPA, 1997).....	6-12
Figure 6-6 Slot cutting machine with close-up of ganged cutter heads (Caltrans, 2006a).....	6-13
Figure 6-7 Three pairs of slots cut in a single pass by a ganged slot cutting machine.....	6-13
Figure 6-8 Details of chair-dowel system in slot.....	6-14
Figure 6-9 Jack hammering (Caltrans, 2006a) .....	6-14
Figure 6-10 Sandblasting (Caltrans, 2006a).....	6-15
Figure 6-11 Sealing joint/crack (Caltrans, 2006a) .....	6-16
Figure 6-12 Placing dowel-chair assembly (Caltrans, 2006a).....	6-17
Figure 6-13 Placing backfill (Caltrans, 2006a) .....	6-18
Figure 6-14 Consolidating backfill (Caltrans, 2006a).....	6-18
Figure 7-1 Marking damage area for removal (FHWA, 2006) .....	7-9
Figure 7-2 Concrete removal using the saw and patch methodology (FHWA, 2006) .....	7-10
Figure 7-3 Concrete removal using the mill and patch methodology (FHWA, 2006).....	7-11
Figure 7-4 Cleaning the repair area with sandblasting equipment (FHWA, 2006).....	7-11
Figure 7-5 Placement of bond breaker at joint (FHWA, 1999).....	7-12
Figure 8-1 Caltrans dowel bar design (Caltrans Standard Plan P8, 2006) .....	8-6
Figure 8-2 Concrete removal using lift out method (Caltrans, 2004) .....	8-9
Figure 8-3 Dowel bar anchoring in slab face (FHWA, 2001).....	8-11

## LIST OF TABLES

Table 1-1 Examples of effectiveness of preventive maintenance (PM) .....	1-3
Table 1-2 Summary of factors affecting JPCP pavement distress.....	1-15
Table 1-3 Structural distress and possible contributing factors.....	1-16
Table 1-4 Functional distress and possible contributing factors .....	1-17
Table 1-5 Most commonly used types of portland cement .....	1-18
Table 3-1 Suggested data item needs for treatment strategies for rigid pavements (FHWA, 2001) ....	3-3
Table 3-2 Proposed trigger values and expected life for various PCC maintenance treatments .....	3-6
Table 3-3 Rigid pavement distress and related repair / preventive maintenance methods.....	3-7
Table 3-4 Trigger and limit values for jointed plain concrete pavements (ACPA, 1998).....	3-8
Table 3-5 Trigger and limit values for jointed reinforced concrete pavements (ACPA, 1998) .....	3-9
Table 3-6 Example worksheet of a selection process incorporating multiple selected decision factors and assigned weightings.....	3-12
Table 4-1 Sealant descriptions and related specifications .....	4-3
Table 4-2 Typical item codes for a joint resealing and crack sealing project .....	4-12
Table 5-1 Typical values for diamond grinding design in California .....	5-5
Table 5-2 Recommended dimensions for diamond grooving design in California (FHWA, 2004) ....	5-5
Table 5-3 Typical item codes for a diamond grinding project .....	5-6
Table 5-4 Trigger values for diamond grinding (FHWA, 2006).....	5-10
Table 5-5 Limit values for diamond grinding (FHWA, 2006).....	5-10
Table 6-1 Summary of project selection criteria .....	6-4
Table 6-2 Recommended backfill material properties (Jerzak, 1994).....	6-8
Table 6-3 Typical item codes for a dowel bar retrofit project.....	6-10
Table 7-1 Distresses addressed by partial depth repairs for jointed concrete pavements .....	7-1
Table 7-2 Properties of normal concrete mixtures used as partial depth repair materials.....	7-3
Table 7-3 Properties of specialty cement mixtures used as partial depth repair materials .....	7-4
Table 7-4 Properties of specialty materials used as partial depth repair materials.....	7-5
Table 7-5 Minimum dimensions of repair area for partial depth repairs.....	7-7
Table 7-6 Typical item codes for an isolated partial depth concrete repair project .....	7-7
Table 8-1 Distresses addressed by full depth repairs for jointed concrete pavements (FHWA, 2001)	8-2
Table 8-2. High Early-strength mix design and approximate opening times (FHWA, 2001).....	8-3
Table 8-3 Typical item codes for an isolated full depth concrete repair project .....	8-6
Table 8-4 Anchoring materials and dowel hole recommendations .....	8-10

# PREFACE

Pavement preservation is becoming more and more important in preserving the conditions of the national highway system. More than 1.75 trillion dollars have been invested in the highway system. Managing and preserving this investment is increasingly the goal of highway agencies around the country. More and more agencies are realizing the benefits of having a sound pavement preservation program. These benefits include improved pavement performance, increased mobility and roadway safety, overall improved customer satisfaction, increased pavement life, and reduced life-cycle costs.

The California Department of Transportation (Caltrans) has been a leader in promoting and advancing pavement preservation technology. Considerable effort has been devoted towards this goal. In 2001, Caltrans developed a maintenance technical advisory guide (MTAG) for flexible pavements. The Federal Highway Administration is currently developing a website for sharing the knowledge contained in MTAG. Because of the latest advances in pavement preservation technologies, Caltrans Division of Maintenance decided to update MTAG by incorporating the most current information and innovation results into the document. The 2nd edition of the MTAG for flexible pavement preservation has recently been completed and reviewed.

Caltrans has also established the Pavement Preservation Task Group (PPTG), a partnership between Caltrans, industry, local agencies and academia to work on important pavement preservation issues. This group decided to expand MTAG to include maintenance strategies for rigid pavements. The first edition of MTAG for rigid pavements was completed in 2006. Caltrans and the PPTG have reviewed the guide and provided extensive comments and recommendations to the present edition.

This 2nd edition consists of eight chapters. Chapter 1 is introduction, presenting a brief overview and purpose of pavement preservation, a discussion of common distresses found in California's concrete roadways, the materials used in maintenance treatments, and important design considerations. Chapter 2 presents a discussion on surface characteristics while Chapter 3 presents a framework for selection of rigid pavement maintenance treatments. Chapters 4 through 8 provide detailed descriptions of five treatments that Caltrans has been successfully using to maintain and preserve their rigid pavements infrastructure. These five treatments include the following:

- Joint Resealing and Crack Sealing;
- Diamond Grinding;
- Dowel Bar Retrofit;
- Isolated Partial and Full Depth Repair; and
- Full Depth Concrete Repair.

This Guide is designed for several levels of use, ranging from general instruction to specific work practice descriptions. It should be of use to District Maintenance Engineers, Maintenance Supervisors, Superintendents, and Field Personnel. Construction personnel and designers will also find the information helpful.

This advisory guide is intended to serve as a comprehensive, useful reference. It will be updated and revised as new information becomes available.

## ACKNOWLEDGMENTS

This document was prepared under the technical direction of Dr. Shakir Shatnawi, Chief of the Office of Pavement Preservation. The document was reviewed by Caltrans Maintenance Personnel, the Pavement Preservation Task Group (PPTG), and the Pavement Standards Team (PST). For questions on the guide, please contact:

Shakir Shatnawi, Chief  
Office of Pavement Preservation  
Division of Maintenance  
Sacramento, CA 95819-4612  
(916) 227-5706

The PPTG was instrumental in the development and review of this Guide. The co-chairs of the PPTG for rigid pavements are Dr. Shakir Shatnawi from Caltrans and Casey Holloway from industry. The PPTG for rigid pavements consists of the following subtask groups:

Subtask Group	Subtask Group Caltrans Co-Chairs/Champions	Subtask Group Industry Co-Chairs/Champions
Diamond Grinding	Richard Stubstad	Casey Holloway
Dowel Bar Retrofit	Kirsten Stahl	Casey Holloway
Joint Re-Seal	Karen Bonnetti	Lowell Parkison
Surface Characteristics	James Lee	Larry Scofield
Research	Michael Samadian	Larry Santucci and Erwin Kohler
Warranties	Jim Cotey	Jack Van Kirk
Quiet Pavements	Bill Farnbach	Larry Scofield
Innovation	Joe Holland	Scott Metcalf and John Roberts
Strategy Selection	Doug Mason	Gary Hicks and John Roberts
Education	Larry Rouen	Brandon Milar and Larry Scofield
Partial/Full Depth Repair	Kirsten Stahl	Vincent Perez

The pavement preservation task group co-chairs have provided technical assistance and review comments at various stages of this project. Their assistance is gratefully acknowledged.

*Disclaimer*

*The contents of this guide reflect the views of the authors who are responsible for the facts and accuracy of the data presented herein. The contents do not necessarily reflect the official views or policies of the State of California or the Federal Highway Administration. This guide does not constitute a standard, specification, or regulation.*

## **CHAPTER 1 INTRODUCTION**

This chapter presents an overview of and purpose for pavement preservation, a discussion of common distress types found on rigid pavements in the California Department of Transportation (Caltrans) roadway system, a description of fundamentals of materials typically used in PCC pavements, and a discussion of important factors that should be considered during the design phase of pavement maintenance for concrete pavements.

### **1.1 PURPOSE OF PAVEMENT PRESERVATION**

In the simplest term, the purpose of pavement preservation is to keep pavements in good or near new conditions by applying the right maintenance strategies at the right time that are cost-effective and extend pavement life and preserve investment. This section briefly describes the definition, concept, and benefits of pavement preservation, and the importance of treatment selection and the optimum timing for the pavement preservation treatments used.

#### *1.1.1 Definition*

Pavement preservation, as defined by the FHWA, is a program employing a network level, long-term strategy that enhances pavement performance by using an integrated, cost-effective set of practices that extend pavement life, improve safety and meet motorist expectations (FHWA, 2005). A pavement preservation program consists primarily of three components: preventive maintenance, minor rehabilitation (restoration), and some routine maintenance (FHWA, 2005). A pavement preservation program does not include new pavements or pavements that require major rehabilitation or reconstruction. Appendix A of this report presents the FHWA's memorandum on definitions of pavement preservation and terminologies associated with pavement maintenance.

#### *1.1.2 Pavement Preservation Concept*

Pavement preservation represents a proactive approach in maintaining the existing highway infrastructure. An effective pavement preservation program addresses pavements while they are still in fairly good condition—before the onset of serious damage or distress. By applying a cost-effective pavement preservation treatment at the right time, the pavement can be restored almost to its original, newly-constructed condition. The cumulative effect of systematic, successive preservation treatments is to postpone costly rehabilitation or reconstruction (FHWA, 2005). Pavement preservation treatments restore the function of the existing structural pavement system and extend its life by reducing aging and restoring its serviceability, not increase its bearing capacity or strength. Performing a series of successive pavement preservation treatments during the life of a pavement is less disruptive to uniform traffic flow than long closures normally associated with reconstruction projects (FHWA, 2005).

Pavement preservation is not simply a maintenance program, but an agency approach. Essentials for an effective pavement preservation program include agency leadership and a dedicated annual budget, and support and input from staff in planning, finance, design, construction, materials, and maintenance.

### 1.1.3 Benefits of Pavement Preservation

An effective pavement preservation program can benefit Caltrans by preserving the roadway network, enhancing pavement performance, ensuring cost-effectiveness by extending pavement life, and reducing user delays by avoiding rehabilitation or reconstruction. Some of these benefits may be noticed immediately and some may be realized over time (Galehouse, Moulthrop, and Hicks, 2003).

### 1.1.4 Treatment Selection and the Optimum Timing for the Treatment

Figure 1-1 shows how a pavement would typically perform under traffic and with time (dotted line). Various treatment stages are also shown in the figure. While the pavement performance curve in the figure is more representative of flexible pavements, the same concept of treatment stages is applicable to rigid pavements as well. It clearly indicates that pavement preservation should be carried out at an early stage of the pavement's life, while it is still in good condition, both structurally and functionally. If the pavement is not maintained effectively, it will eventually deteriorate to a point where the only choice is reconstruction, which is the most costly option.

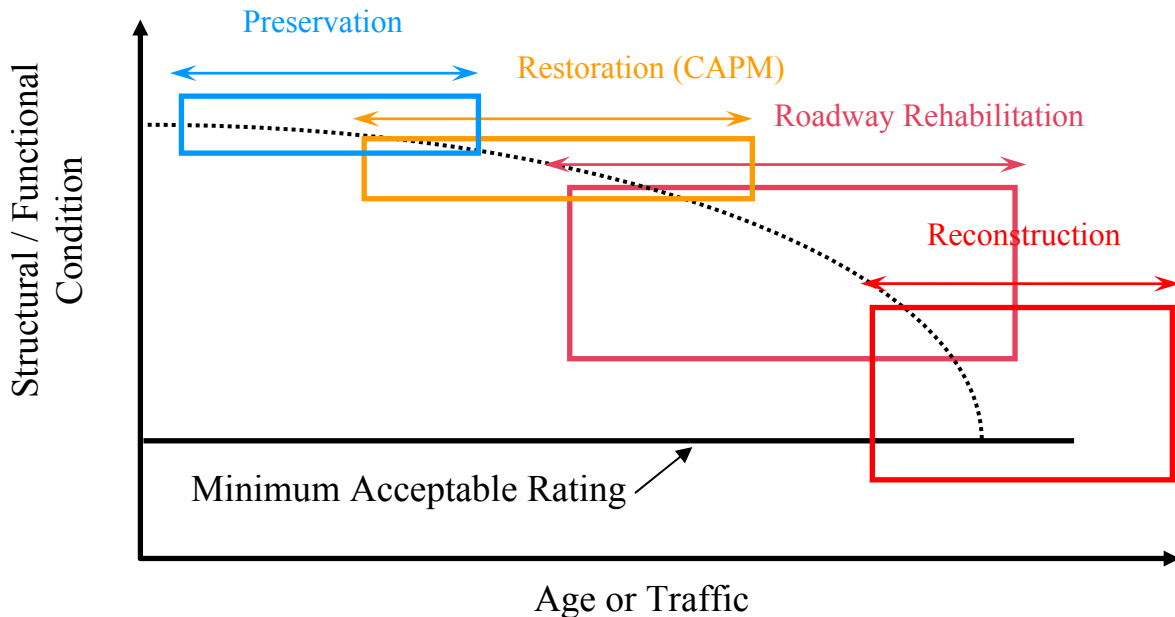

Figure 1-1 Typical pavement performance curve and maintenance/rehabilitation time

The timing of the application of the treatment has a significant influence on the effectiveness of the treatment in prolonging the performance of the pavement. Therefore, applying the right treatment to the right pavement at the right time is the core concept behind *pavement preservation*. As indicated in the foregoing, by applying cost-effective preservation treatments at the right time, the pavement can be maintained close to its original condition for a longer period of time. The timely application of successive treatments can maintain the pavement in good condition and preclude the need for more expensive roadway rehabilitation and reconstruction strategies, as shown in Figure 1-2. This figure illustrates the concept of how the timely application of treatments is paramount in maintaining the



existing pavement condition. The frequency of applying these treatments will depend on the type of treatments that have been used and their life expectancy.

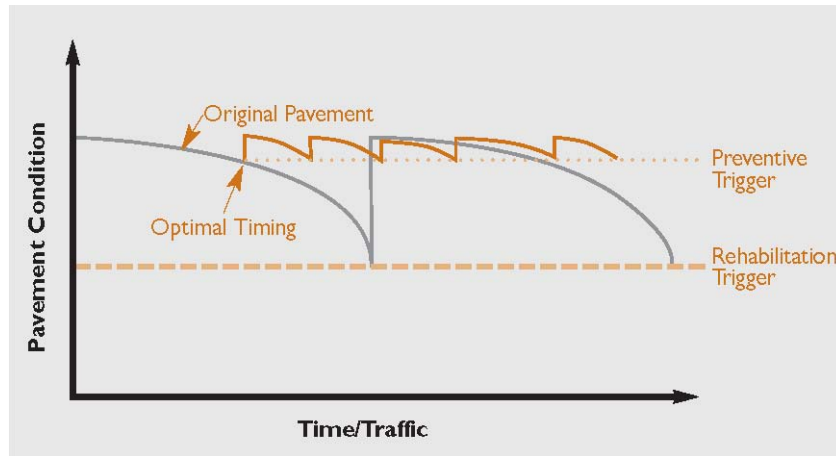

Figure 1-2 Concept of optimal timing for pavement preservation (Galehouse et al, 2003)

Table 1-1 shows examples on the effectiveness of preventive maintenance for selected PCC pavement problems and provides an indication of when an application of preventive maintenance might be appropriate or might be too late. Specific treatment selection and the optimum timing for the treatment are a function of many factors, including pavement condition, distress types, traffic, constructability, economics, and other factors specific to the project. Chapter 3 provides more detailed guidelines on treatment selection.

Table 1-1 Examples of effectiveness of preventive maintenance (PM)

Example PCC Pavement Problem	Prevented or slowed with PM	Corrected with PM	Indications that it is too late for PM
Crack deterioration	X (minor)		X (severe)
Corner breaks	X (minor)		X (severe)
Blow-ups	X (minor)		X (severe)
Joint spalling	X	X	
Joint faulting		X	
Joint seal damage		X	
Map cracking and scaling		X	
Surface friction loss		X	
Roughness	X	X	

## 1.2 PCC PAVEMENT DESIGN AND PERFORMANCE IN CALIFORNIA

### 1.2.1 Design and Performance

With the exception of a few experimental test sections of Continuously Reinforced Portland Cement Concrete Pavement (CRCP), California’s rigid pavements are generally of the Jointed Plain Concrete Pavement (JPCP) variety. Most of these pavements were built from the 1950s through the 1970s. There has also been a substantial amount of new rigid pavement constructed since the 1970’s. The design life for rigid pavements was traditionally 20 years and most have out lived their design life with

little maintenance. California's rigid pavements on freeways have been functional often far beyond their design life of 20 years, and most of them have not deteriorated as originally anticipated. Current design standards require or encourage a 40-year design life. Currently, an effort is underway at Caltrans to design an improved 100-year design life rigid pavement by using the newest technology, good construction techniques and equipment, and improved materials.

By taking into account rigid pavement performance over the years as well as of continuing advances in paving technology, equipment, and materials, standard structural designs for rigid pavements have improved over the years. Major design changes included:

- Base support. Initially, cement treated base (CTB) was used. This material was later replaced by lean concrete base (LCB), which is a low cement content concrete that could be slip-formed or cast in forms. Caltrans has also used cement treated permeable base (CTPB), which is a concrete base batched with no sand to allow water to pass through the base with ease. Caltrans has also used asphalt treated permeable base (ATPB), which is an asphalt concrete (AC) base with a lesser amount of asphalt binder than conventional AC.
- Slab thickness. In the 1950s, an 8-inch (203 mm) thick slab was the common practice with a few 9-inch (229 mm) slabs. Later, a 9-inch (229 mm) thick slab became common practice. Presently, 10-inch (254 mm) and even some 12-inch (305 mm) thick slabs are used depending on projected traffic.
- Dowels, tie bars, and sealed joints were added in 2000.

There were also minor changes with regards to structural performance such as surface texturing, joint spacing and layout, and details for sealing joints.

For the most part, the concrete mixture materials used in the pavement slab have remained fairly constant. One could use 1950's pavement slab materials specifications and be close to current Caltrans Standards. Flexural strengths have also been relatively constant. One notable exception would be the current mineral admixture requirements that were added to address reactive aggregate or alkali-silica reactivity (ASR) concerns. Requirements on strength, curing, batching, mix transporting, slump and penetration have remained relatively constant over the last 50 years.

However, increasing traffic loads and numbers of heavy axle applications have had a significant, detrimental effect on rideability, and eventually durability, of the pavement structure. This was seen as the primary reason that our rigid pavements started showing surface distress.

The foremost distress in California for rigid pavements over CTB was faulting. This distress occurred over time with the up-stream slab rising in relation to the adjacent edge of the down-stream slab, creating a rough ride and eventually cracking near the joints. It was noted that when LCB became commonly used, the amount and occurrence of faulting reduced. This was because LCB had no loose or weakly bonded materials on its surface, thus reducing potential pumping caused by the presence of water and fine materials. Extended base width into the shoulder also helped reducing pavement slab faulting. CTPB and ATPB were used to remove water from the interface between the base and pavement slab to eliminate the mechanism for carrying fines from the down-stream slabs to up-stream slabs. Edge drains were intended to serve the same purpose. Though faulting may have initially been thought of as a ride issue, its presence became a key to the structural deterioration of PCC pavements that were constructed on erodible bases such as CTB.

### 1.2.2 Causes of Rigid Pavement Deterioration

There are several causes of pavement failure that are of interest to maintenance personnel: one general cause is an improper construction practice resulting in the pavement structure not being built as designed; a second is the condition of the project site being incompletely or erroneously analyzed without proper consideration of the “ambient” or environmental impact to the pavement coupled with the inadequacy of a given pavement maintenance schedule.

Such problems are not necessarily due to a flaw or inadequacy in rigid pavement design, but rather not properly transferring theory into practice. Other issues may involve unforeseen changes at the site (such as an increase in traffic loads) after construction. Underestimating wheel loads, improper construction practices, material related distresses, or a changing environment (such as the appearance of ground water after construction) are other examples of unforeseen changes after construction. A couple of real life examples are given below as illustrations of these types of deterioration.

In 1998, a small section of I-5 in Sacramento County near the Pocket Road interchange was in need of replacement. The pavement was designed to be built on a lime treated base course. This section of freeway was failing even though it had experienced nowhere near the traffic loads anticipated during the design phase. However, the lime treated base did not behave as anticipated, possibly due to improper construction practice. Lime was found in the drainage pipes and the base was not intact. This was likely due to inadequate curing of the lime treated base. If the lime treated base did not reach its designed strength before the PCC slabs were placed, the stability and load bearing capacity of the base would likely be inadequate. Since lime was found in the drainage pipes, it is possible that some of the lime leached out of the base. This was believed to be the primary cause of the pavement failure. Rehabilitation included removing the entire pavement structure, lime-treating the base again, and reconstructing a new pavement structure using the latest Caltrans standards.

Another example of premature pavement failure was the repaving of I-80 near Truckee, California. The project is in a freeze-thaw zone and air entrainment was required. After only a one year of service, the pavement began to exhibit corner cracking in almost all the slabs. At first it was thought that the 8-inch slab thickness might not be sufficient. Upon further investigation, however, it was discovered the air content in the concrete was as much as 12%. As a result of this high air content, flexural strengths were low. Proper maintenance on this roadway should have considered the fact that the corner cracking was primarily due to weakened concrete.

Fortunately, such examples of premature rigid pavement deterioration are fairly rare. Oftentimes they are due to human error in incorporating sound and established engineering principles. The first example, above, shows how deterioration caused by unforeseen circumstances can have far reaching implications because pavement deterioration becomes inadvertently built into the design. The second example shows how a lack of understanding of how a pavement performs under traffic loads and other factors can affect pavement performance.

### 1.2.3 Faulting Mechanism and Effort on Addressing Faulting

In California, faulting is one of the primary and most serious distresses on jointed plain concrete pavements. Understanding its mechanism is important to address this type of pavement deterioration. There are typically four conditions that must exist to have pavement faulting. First there must be some curl of the slab. Thermal gradients are the main cause of slab curling. Second there must be fines present that can be moved around by water. Third there must be water present to carry the fines away from the underlying materials. And lastly, the adjacent slabs at the joint must be free to move independently from one another—that is the up-stream slab must be able to rebound upward after the

wheel load leaves the slabs and depresses the down-stream slab. If any one of these four conditions is not present, faulting should not occur.

When faulting reaches the point where there is a drop-off (Figure 1-3) from the up-stream slab to the down-stream slab of 0.06 inches (1.5 mm) or more, pavement maintenance becomes an issue. The shoulder begins to depress and cracks, mostly on the down-stream side of the joint, begin to appear. As faulting increases, the shoulder deterioration and/or drop-off also increase. The ride quality of the roadway becomes poor as the height of the drop-off increases with time and load applications. Although the ride quality can be restored with diamond grinding, this temporary measure will not address the causal deterioration of the pavement structure. As joint faulting continues, the support in the up-stream edge of the slab becomes less and less so the slab functions much like a cantilevered bridge or beam. Eventually, transverse cracks appear near the edge of slab where it is still being supported by the base. As conditions worsen, the slab without adequate base support will crack. This often occurs 3-6 feet from the transverse joint. This newly formed short slab now has to withstand longitudinal stresses that are increased due to the loss of the cross sectional area on the opposite side of the crack. Additionally, the pavement begins to fault at the crack, which is now functioning as a new joint. Further deterioration at this location can form third stage cracking. At this late stage in pavement deterioration, slab replacement is probably the only viable rehabilitation strategy. As more slabs exhibit third stage cracking, the pavement may need major rehabilitation.

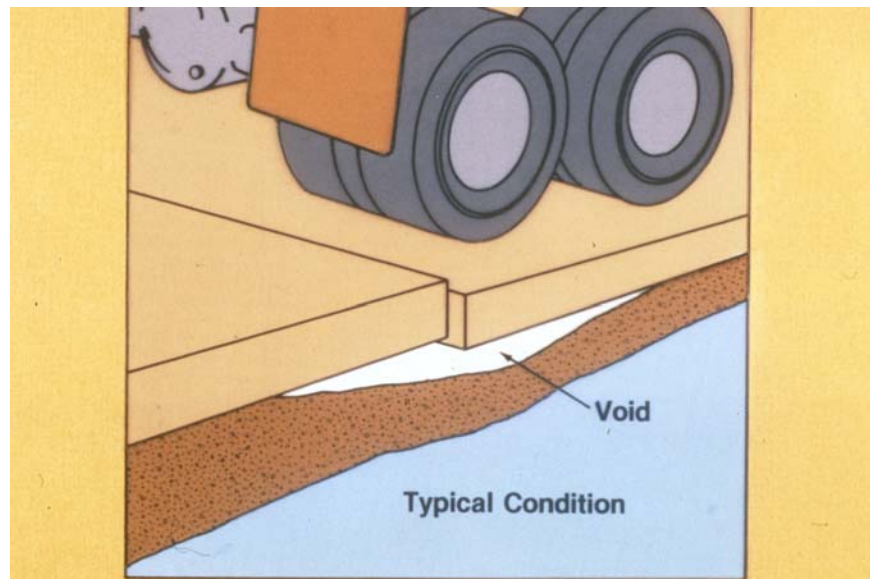

Figure 1-3 Slab drop-off caused by base erosion (Stahl, 2006)

Efforts to enhance the durability of jointed plain concrete pavements gradually centered on addressing the faulting of pavement slabs as well as increasing slab thickness. In recent years, some of the efforts to minimize faulting of existing jointed concrete pavements have included adding dowel bars at existing transverse joints, also referred to as dowel-bar retrofit.

### 1.3 COMMON PCC PAVEMENT DISTRESS TYPES

Distresses commonly found in the California's concrete pavements can generally be grouped into three categories: joint deficiencies and cracking; surface defects; and other miscellaneous distresses (e.g., blow-ups and pumping).

### 1.3.1 Joint Deficiencies and Cracking

This group of distress typically includes spalling of transverse and/or longitudinal joints, damage of transverse and/or longitudinal joint seal, transverse and/or longitudinal cracking, durability cracking, and corner breaks.

**Spalling** – Spalling of cracks and joints is the cracking, breaking, chipping, or fraying of slab edges within 2 ft (0.6 m) of a joint or crack. A spall usually does not extend vertically through the whole slab thickness but extends to intersect the joint at an angle. Spalling generally results from one or more of the following root causes:

- Excessive stresses at the joint or crack caused by infiltration of incompressible materials and subsequent expansion;
- Weak concrete at the joint;
- Joint sawing time or insert method during the construction;
- Poorly designed or constructed load transfer device (misalignment, corrosion);
- Heavy repeated traffic loads;
- Disintegration of the concrete from the freeze-thaw action of “D” cracking (for various reasons this distress type does not occur in California, however).

Spalling is typically caused by slab expansion (in warm weather) and contraction (in cool weather). The slab expansion/contraction opens joints and allows incompressible debris trapped in the joint. As joints close, trapped incompressible debris causes fractures of the slab and enlarges the joints, thus permitting larger debris to be trapped and consequently causing greater fractures. Examples of spalled pavements are given in Figure 1-4.

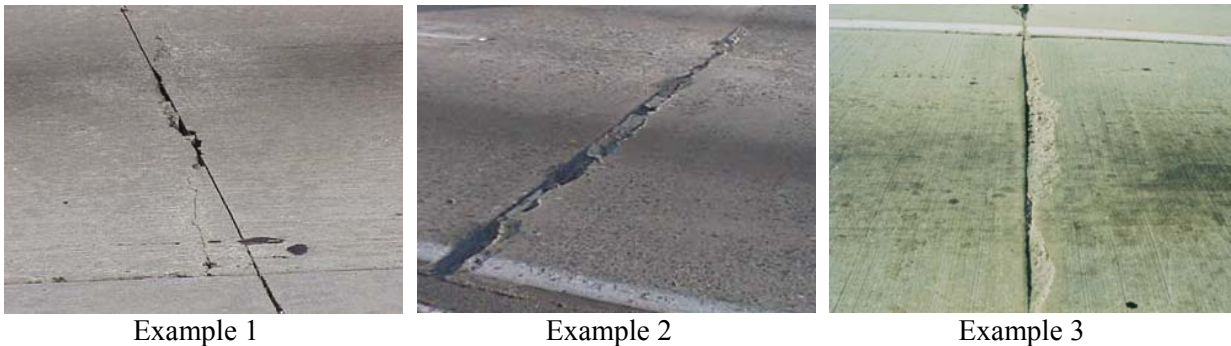

Figure 1-4 Spalling at the joint (Caltrans, 2004a)

**Faulting** – Faulting is the difference in elevation across a joint or crack (see Figure 1-5). Faulting is caused in part by a buildup of loose materials under the approach slab near the joint or crack as well as depression of the leave slab. The buildup of eroded or infiltrated material is caused by pumping from under the leave slab and shoulder (free moisture under pressure) due to heavy loadings. The warp and/or curl upward of the slab near the joint or crack due to moisture and/or temperature gradient contributes to the pumping condition. Lack of load transfer devices like dowel bars contributes greatly to faulting. Faulting is the most prominent failure type in California because Caltrans did not begin building doweled concrete pavements until 1998. A detailed discussion on the faulting mechanism is provided in Section 1.2.3.



Figure 1-5 Faulting (FHWA, 2003)

**Joint seal damage** – Joint seal damage exists when incompressible materials and/or water are allowed to infiltrate the joints (Figure 1-6). This infiltration can result in pumping, spalling, and blow-ups. A joint sealant bonded to the edges of the slabs protects the joints from accumulating incompressible materials and also reduces the amount of water seeping into the underlying pavement structure. Typical types of joint seal damage are: stripping of joint sealant, extrusion of joint sealant, weed growth, hardening of the filler (oxidation), loss of bond to slab edges, and the lack or absence of sealant in the joint. Poor construction of the joint seal can be a factor in the extent of joint seal damage.



Figure 1-6 Example of joint seal damage (FHWA, 2003)

**Longitudinal cracks** – longitudinal cracks occur generally parallel to the centerline of the pavement (Figure 1-7). They are often caused by a combination of heavy load repetitions, loss of foundation support, and thermal and moisture gradient stresses. Longitudinal cracking is more prevalent in the western states, which have a drier climate than in the more humid eastern states. Early longitudinal cracks can be caused by improper construction of longitudinal joints, inadequate saw-cut depth, late sawing of longitudinal joints, and/or opening the pavement to traffic before the concrete has achieved adequate strength.





Example 1

Example 2

Figure 1-7 Examples of longitudinal joint crack (FHWA, 2003)

**Transverse cracking** – transverse cracks are predominantly perpendicular to the pavement centerline and the direction of traffic (Figure 1-8). Typically, JPCP slabs crack when tensile stresses within the slab exceed the slab’s tensile strength. Early-age cracking may occur from a combination of restraining forces due to temperature changes, shrinkage, thermal curling, base constraint, and moisture warping combined with traffic loads imposed on the concrete before it has gained sufficient strength. Transverse cracks that occur in the years following construction are primarily the result of fatigue of the concrete slab caused by repeated heavy axle loads and temperature curling. The cracks develop when the accumulated fatigue damage approaches or exceeds the fatigue life of the JPCP. Note that the potential for transverse cracking increases with increased joint spacing. Old JPCP designs used 18 ft (5.5 m) and 19 ft (5.8 m) spacing, which historically have cracked over twice as often as shorter 12 ft (3.7 m) and 13 ft (4 m) joint spacing. Caltrans now limits joint spacing to 15 ft (4.6 m).



Figure 1-8 Transverse cracking (FHWA, 2003)

**Slab cracking** – Caltrans classifies slab cracking by stages based on the severity of the cracks (Caltrans, 2004). Figure 1-9 shows examples of cracks at stage 1 and stage 3. First stage cracking is defined as transverse, longitudinal or diagonal cracks that do not intersect and that divide the slab into two or more large pieces. Third stage cracks are interconnected cracks that divide the slab into three or more large pieces. Fragmented slabs are characterized by interconnected, irregular multiple cracks which divide the slab into several small pieces. Fragmented slabs are a severe form of third stage cracking. Third stage cracking and first stage cracking cannot co-exist in the same slab. However, corner cracking may co-exist with both first stage and third stage cracking. Slab cracking is usually

caused by a combination of heavy load repetitions on pavement with weak roadbed support, thermal curling, faulting, shrinkage or moisture-induced stresses.



Figure 1-9 Examples of cracks at different stages (Caltrans, 2004a)

**Corner break (or cracking)** – A corner break is a crack that occurs in JPCP at the joints situated a distance less than 6 ft (1.8 m) on each side of the slab, as measured from the corner of the slab. A corner break extends vertically through the entire slab thickness. Corner breaks result from heavy repeated loads combined with pumping, poor load transfer across joints, and thermal curling and moisture warping stresses as shown in Figure 1-10. Corner breaks can also result from a weak or a thin concrete section constructed on a weak base.



Figure 1-10 Corner break/cracking (Caltrans, 2004a)

**Durability (“D”) cracking** – “D” cracking is a series of closely spaced crescent-shaped hairline cracks that appear at a JPCP pavement slab surface adjacent and roughly parallel to transverse and longitudinal joints, transverse and longitudinal cracks, and the free edges of a pavement slab. These relatively narrow surface cracks often curve around the intersection of longitudinal joints/cracks and transverse joints and cracks (Figure 1-11). These surface cracks often contain calcium hydroxide residue which causes a dark coloring of the crack and immediate surrounding area. “D” cracking is caused by freeze-thaw expansive pressures of certain types of coarse aggregates and typically begins at the bottom of the slab which disintegrates first.

In California, alkali-silica reactivity (ASR) related distress is far more prominent. ASR is another durability-related distress which typically produces “map-cracking” type cracks as shown in Figure 1-12. ASR is caused by a chemical reaction that occurs when free alkalis in the concrete combine with



certain siliceous aggregates to form an alkali-silica gel. As the gel forms, it absorbs water and expands, which cracks the surrounding concrete (ACPA, 1998).



Figure 1-11 D-Cracking (Caltrans, 2004b)



Figure 1-12 Map-cracking (FHWA, 2003)

### 1.3.2 Surface Defects

**Scaling** – Scaling is the deterioration of the upper  $\frac{1}{8}$  to  $\frac{1}{2}$  inch (3 to 13 mm) of the concrete slab surface. Map cracking or “crazing” is a series of cracks that extend only into the upper surface of the slab surface (Figure 1-13). Map cracking or crazing is usually caused by over-finishing of the slab, premature finishing, or early freezing of concrete that may lead to scaling of the surface. Scaling can also be caused by reinforcing steel, such as dowel bars and tie bars placed too close to the pavement surface.

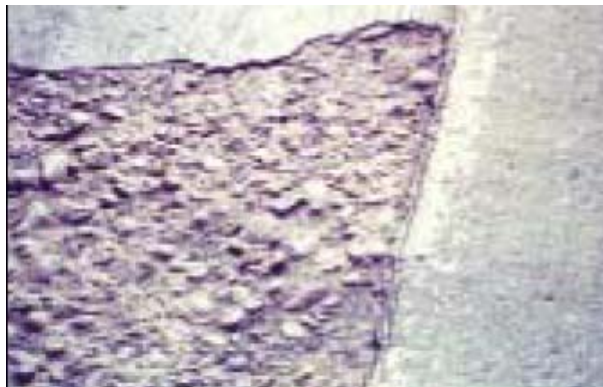

Figure 1-13 Example of scaling (FHWA, 2003)

**Surface polish/polished aggregate** – Surface polish is the loss of the original surface texture due to traffic wear. Aggregate polishing occurs when the surface mortar and texturing have been worn away, exposing coarse aggregate, and is caused by repeated traffic applications. An example is shown in Figure 1-14.

**Surface attrition/abrasion** – Surface attrition or abrasion is abnormal wear of the concrete pavement (Figure 1-15). It can result from either a poor quality surface material or the coarse aggregate, or by the action of tire chains and studded tires. Excessive wear in wheel paths may cause “rutting”, a condition which typically occurs in the high elevation mountain or desert climatic regions of California, due to the use of tire chains during snow storms.



Figure 1-14 Example of surface polish/polished aggregate (FHWA, 2003)



Figure 1-15 Severe surface abrasion with third stage cracking (Caltrans, 2004b)

**Popouts** – A popout is a small piece of concrete that breaks loose from the surface due to freeze-thaw action, expansive aggregates, and/or nondurable materials. Popouts may be indicative of unsound aggregates and “D” cracking (Figure 1-16). Popouts typically range from approximately 1 inch (25 mm) to 4 inches (100 mm) in diameter and from ½ inch to 2 inches (13-51 mm) in depth.



Figure 1-16 Example of popouts (FHWA, 2003)

### 1.3.3 Other Miscellaneous Distresses

**Blow-ups** – The mechanism leading to blow-ups is excessive compressive pressure at joints or cracks. Infiltration of incompressible materials into the joint or crack during cold periods results in high

compressive stresses during hotter periods when slabs expand (Figure 1-17). When this compressive pressure becomes too great, a localized upward movement of the slab and a complete shattering occurs near the joint. Blow-ups are accelerated due to the spalling away of the slab at the bottom, thus creating reduced joint contact area. The presence of “D” cracking (although this distress type does not exist in California’s rigid pavements) or freeze-thaw damage also weakens the concrete near the joint, resulting in increased spalling and blow-up potential.



Figure 1-17 Example of blow-ups (FHWA, 2003)

**Pumping and water seepage** – Pumping is the movement of material by water pressure beneath the slab when it is deflected under a heavy moving wheel load (Figure 1-18). Sometimes the pumped material moves around beneath the slab, but more often it is ejected through the joints and/or cracks (particularly along the longitudinal lane/shoulder joint with an asphalt shoulder). Beneath the slab there is typically particle movement that occurs counter to the direction of traffic across a joint or crack, resulting in a buildup of loose materials under the approach slab near the joint or crack. Pumping occurs even in pavement sections containing stabilized subbases. Pumping can oftentimes increase joint faulting. Water seepage occurs when water seeps out of joints and/or cracks. Oftentimes it drains out over the shoulder in lower-lying areas.



Example 1



Example 2



Example 3

Figure 1-18 Examples of pumping and water seepage (Caltrans, 2004a)

**Lane/shoulder drop-off** – Lane/shoulder drop-off occurs when there is a difference in elevation between the traffic lane and the shoulder (Figure 1-19). Typically, the outside shoulder settles due to a settlement of the underlying granular or subgrade materials or to pumping of the underlying material. This condition is found only in the case of an asphalt shoulder, or as a result of pumping.





Figure 1-19 Lane/shoulder drop-off (FHWA, 2003)

**Settlement** – Settlement is a local sag in the pavement structural section due to differential settlement, consolidation, or movement of the underlying layer material (Figure 1-20). Sag most commonly occurs above culverts due to the settlement or densification of backfill or at grade points between cut and fill sections. Pavement slippage could also contribute to differential settlement of the pavement and longitudinal cracking.



Figure 1-20 Settlement (Caltrans, 2004b)

1.3.4 Summary

Table 1-2 provides a summary of factors that affect the pavement distresses commonly found on JPCP in California. These factors are grouped as traffic- and load-related and/or climate- and materials-related. The distinction between traffic/load and climate/materials would be important to the selection of treatment.

Table 1-2 Summary of factors affecting JPCP pavement distress

Distress Type	Traffic/Load	Climate/Materials
<i>Joint Deficiencies and Cracking</i>		
Spalling		X
Faulting	X	X
Joint Seal Damage	X	X
Longitudinal Cracking	X	X
Transverse Cracking	X	X
Slab Cracking *	X	X
Corner Breaks/Cracks	X	
Durability “D” Cracking		X
<i>Surface Defects</i>		
Scaling and Map Cracking		X
Surface Polish/Polished Aggregate	X	X
Surface Attrition (include rutting)	X	X
Popouts		X
<i>Miscellaneous Distresses</i>		
Blow-ups		X
Water Seepage and Pumping	X	X
Lane-to-Shoulder Drop-off		X
Settlement	X	X

\* Does not occur in California.

The American Concrete Pavement Association (ACPA, 1998) developed guidelines for identifying structural and functional distresses and their possible contributing factors. These guidelines are provided in Tables 1-3 and 1-4.

Table 1-3 Structural distresses and possible contributing factors (ACPA, 1998)

Structural Distress	Contributing Factors *					
	Pavement Design	Load	Water	Temp.	Pavement Materials	Construct.
<b>Cracking **</b>						
<i>Transverse</i>	P	P	N	C	C	P
<i>Longitudinal</i>	P	P	N	C	C	P
<i>Corner</i>	C	P	C	C	N	N
<i>Intersecting</i>	C	P	C	N	C	N
<u>Possible causes of cracking:</u> Fatigue, joint spacing too long, shallow or late joint sawing, base or edge restraint, loss of support, freeze-thaw and moisture related settlement/heave, dowel-bar lock-up, curling and warping.						
<b>Joint/Crack Deterioration</b>						
<i>Spalling</i>	C	C	N	C	P	C
<i>Pumping **</i>	C	P	P	N	C	N
<i>Blow-ups</i>	C	N	N	P	C	N
<i>Joint Seal Damage **</i>	C	C	C	C	P	C
<u>Possible causes of joint/crack deterioration:</u> Incompressibles in joint/crack, material durability problems, subbase pumping, dowel socketing or corrosion, keyway failure, metal or plastic inserts, rupture and corrosion of steel in JRCP, high reinforcing steel.						
<b>Punchouts **</b>						
	P	P	C	N	C	N
<u>Possible causes of punchouts:</u> Loss of support, low steel content, inadequate concrete slab thickness, poor construction procedures.						
<b>Durability</b>						
<i>D-cracking</i>	N	N	P	C	P	N
<i>ASR</i>	N	N	P	C	P	N
<i>Freeze-thaw damage</i>	N	N	P	P	P	C
<u>Possible causes of durability distresses:</u> Poor aggregate quality, poor concrete mixture quality, water in the pavement structure.						

\* P= Primary Factor C= Contributing Factor N= Negligible Factor

\*\* Loss of support is an intermediary phase between the contributing factors and these distresses. Loss of support is affected by load, water and design factors.

Table 1-4 Functional distresses and possible contributing factors (ACPA, 1998)

Functional Distress	Contributing Factors *					
	Pavement Design	Load	Water	Temp.	Pavement Materials	Construct.
<b>Roughness</b>						
<i>Faulting</i> **	P	P	P	C	C	N
<i>Heave / swell</i> **	C	N	P	P	C	N
<i>Settlement</i> **	C	C	C	N	N	C
<i>Patch deterioration</i>	C	C	C	C	C	C
<u>Possible causes of roughness:</u> Poor load transfer, loss of support, subbase pumping, backfill settlement, freeze thaw and moisture related settlement/heave, curling and warping and poor construction practices.						
<b>Surface Polishing</b>	N	C	N	N	P	N
<u>Possible causes of surface polishing:</u> High volumes of traffic, poor surface texture, wide uniform tine spacing, wide joint reservoirs, and wheel path abrasion because of studded tires or chains.						
<b>Noise</b>	P	C	N	N	C	P
<u>Possible causes of noise:</u> High volumes of traffic, poor surface texture, wide-uniform tine spacing, wide joint reservoirs, and wheel path abrasion because of studded tires or chains.						
<b>Surface Defects</b>						
Scaling	N	N	C	C	P	P
Popouts	N	N	C	C	P	C
Crazing	N	N	N	C	C	P
Plastic shrinkage cracks	N	N	N	C	C	P
<u>Possible causes of surface defects:</u> Over-finishing the surface, poor concrete mixture, reactive aggregates, and poor curing practices.						

\* P= Primary Factor C= Contributing Factor N= Negligible Factor

\*\* Loss of support is an intermediary phase between the contributing factors and these distresses. Loss of support is affected by load, water and design factors.

#### 1.4 MATERIAL CONSIDERATIONS

Concrete consists of a blend of cement, coarse- and fine-grained aggregate, water, and some admixtures if appropriate. Admixtures may be included in the mix to entrain air or modify certain properties of the fresh concrete (e.g., to accelerate or retard the rate of set). In addition, other cementitious or pozzolanic materials, such as fly ash or slag, may be added to the mix to achieve a specific design objective (e.g., to decrease permeability or to reduce reactive aggregate potential). An understanding of each component used in a concrete mix is essential to achieve the desired

performance of a rigid pavement. Materials typically used to repair rigid pavements include cementitious repair materials, specialty repair materials, bituminous materials, and joint sealants.

#### 1.4.1 Concrete Constituent Materials

##### Cementitious Materials

Portland cement is made up of lime, iron, silica, and alumina. These materials are broken down, blended in the proper proportions, and then heated in a furnace at a high temperature to form a product called “clinker.” The clinker, when cooled and pulverized, is then ready for use as “portland” cement. By varying the materials that are used in the production of cement as well as the fineness of the grinding, different cement types are created.

The most commonly used types of portland cement nationally are shown in Table 1-5 (FHWA, 2001). The most common cement type employed in pavement construction in the United States is Type I, although Type III cements are gaining more widespread use, particularly in applications where high early strength is needed (Van Dam et al., 2000). Air-entrained cement, designated with an “a” in table 1-3, have small quantities of air-entraining material ground with the clinker during cement production. In the United States, portland cements are usually governed under the specifications of ASTM C 150.

Table 1-5 Most commonly used types of portland cement

Cement Type	Differentiating Characteristic(s)
Type I	Normal
Type Ia	Type I with air entraining agent
Type II	Moderate heat of hydration, moderate sulfate resistance
Type IIa	Type II with air entraining agent
Type III	High early strength
Type IIIa	High early strength with air entraining agent
Type IV	Low heat of hydration, low strength gain
Type V	High sulfate resistance

Caltrans standard specifications (Caltrans, 2006) specify that portland cement shall be either “Type IP (MS) Modified cement, “Type II Modified” portland cement or Type V portland cement. Type III portland cement shall be used only as allowed in the special provisions for locations where traffic needs to be placed on the concrete shoulder after it is placed. Additional requirements for these cements can be found in Section 90 of the Caltrans Standard Specifications and accompanying special provisions. Cement furnished without a Certificate of Compliance shall not be used in the work until the Engineer has had sufficient time to make appropriate tests and has approved the cement for use (Caltrans, 1999). The Office of Rigid Pavement Materials and Structural Concrete (ORPMSC) is the focal point for Caltrans concrete needs (<http://www.dot.ca.gov/hq/esc/Translab/rpsc.htm?id=translab-cd6>). Caltrans continuously updates their specifications and test methods to reflect the latest concrete practices. The Caltrans ORPMSC works with the District Materials Engineers (DME) to assist in making recommendations for both new projects and the rehabilitation of existing projects. The ORPMSC has four sections: the Concrete Consultations and Investigations Section, the Aggregate Section, the Cement Section, and the Concrete Section. They provide technical expertise, recommendations and quality assurance testing for the cement, supplementary cementitious materials, admixtures, aggregate and concrete.



## **Aggregate**

Aggregates include both gravels and crushed stone (quarried). Gravels are generally considered to be the most cost effective in concrete mixes, but have the highest coefficient of thermal expansion which negatively affects pavement performance. JPCP is made up of coarse aggregates (those retained by a No. 4 [4.75-mm] sieve), and fine aggregates (those passing a No. 4 [4.75-mm] sieve). Aggregates typically make up between 60 and 75 percent of the total volume of a concrete mix (PCA, 1992). Thus, the properties of the aggregate have a significant effect on the durability, behavior, and performance of JPCP pavements.

The aggregate selected for use in a concrete pavement must meet the requirements of Section 90, although this alone does not ensure that the aggregate will perform well. Perhaps one of the most critical properties of the aggregates is its durability—its resistance to chemical and physical degradation due to both internal and external forces. That is, aggregates must be able to resist freezing and thawing and moisture cycling without incurring damage to themselves or the surrounding cement paste; they also must not be susceptible to deleterious chemical reactions (such as alkali-aggregate reaction) that can destroy the matrix of the concrete (Van Dam et al., 2000). Additional laboratory testing is often required to ensure durability.

Traditional grading requirements presented in standard mix design procedures are based on the use of separate coarse- and fine-aggregate gradations, as prescribed by Section 90. However, some agencies have been experimenting with the use of a so-called “continuous” aggregate gradation, which is believed to improve the workability and durability of the resulting mixture.

The Caltrans Standard Specifications require the contractor to submit the proposed gradation of the primary aggregate nominal sizes before beginning concrete work (Caltrans, 2006). If a primary coarse aggregate or the fine aggregate is separated into 2 or more sizes, the proposed gradation shall consist of the gradation for each individual size, and the proposed proportions of each individual size combined mathematically to indicate one proposed gradation. The proposed gradation shall meet the grading requirements described in the specifications (Caltrans, 2006).

## **Water**

In general, water that has no pronounced taste or odor may be used to make concrete for JPCP (PCA 1992). ASTM C 94 provides acceptance criteria for the use of a questionable water supply. Caltrans requirements on water quality vary depending on type of work. Allowable amount of chlorides as Cl, sulfates as SO<sub>4</sub>, and impurities in the water are specified in Section 90 of the Caltrans Standard Specifications (Caltrans, 2006).

The water-cementitious ratio or the ratio of the weight of total water in the concrete mixture to the weight of cementitious materials in the mix is an important mix design parameter. The water-cementitious ratio is one of the most important factors contributing to the strength of the concrete; however the importance of durability, permeability, and abrasion (wear) resistance should not be overlooked (PCA, 1992). Aggregate quality also affects the strength of the concrete. Typical water-cementitious ratios for concrete paving materials are between 0.40 and 0.50 (Van Dam et al., 2000).

## **Admixtures**

Admixtures are added to plastic (still wet) concrete in order to obtain specific desirable characteristics. These include air entraining agents, water reducing agents, and set accelerators or set retardants. Each of these admixtures alters a specific property of the plastic mix. Some admixtures, such as accelerators, retardants, and water reducing agents are used to obtain specific results during placement.

These materials are added to increase concrete workability or to improve handling under otherwise adverse conditions. Other admixtures, such as air entraining agents, are used to enhance the concrete's long-term properties. Air entraining admixtures introduce a matrix of air bubbles into concrete so that water trapped in the pavement has room to expand and contract when frozen or thawed. The use of air entrainment is essential to sound concrete constructed in areas subjected to freezing and thawing cycles.

Section 90-4 of the Caltrans standard specifications, along with the project's special provisions, describes what admixtures and the amount of admixtures allowed or not allowed for use, what ASTM or other designations should be conformed to, and the approval process to use admixtures. The project specifications must be carefully followed to achieve the intended, desired characteristics of adding admixtures.

Caltrans publishes a list of approved admixtures for use in its concrete projects. This list is updated periodically for reference, primarily by Caltrans and others involved in Caltrans projects. The approved list of admixtures may be found at the Caltrans website at the following address:

[http://www.dot.ca.gov/hq/esc/approved\\_products\\_list/](http://www.dot.ca.gov/hq/esc/approved_products_list/)

#### *1.4.2 Cementitious Repair Materials*

Cementitious repair materials can generally be classified into two categories: normal concrete mixtures and high-early-strength mixtures. Each mixture is manufactured for its intended usage; therefore, the manufacturer's recommendations must be strictly followed. These materials are typically used for dowel bar retrofit, isolated partial and full depth repairs, and slab replacement. Details can be found in Chapters 6 and 7 of this report.

#### *1.4.3 Specialty Repair Materials*

There are two major types of specialty repair material: rapid-strength proprietary materials and polymer concretes. Rapid-strength proprietary materials must be used according to the manufacturer's recommendations concerning suitable temperature ranges for placement, bonding, curing, and opening time. Some proprietary materials are very sensitive to temperature and construction procedures (ACPA, 1998). Polymer concretes are a combination of polymer resin, aggregate, and a set initiator. Polymer concretes are categorized by the type of resin used, such as epoxies, methacrylates, and polyurethane (Patel, Mojab and Romine, 1993; Smith et al, 1991). Details can be found in Chapter 7 of this report. Polyester concrete has sometimes been used in overlays, and it consists of polyester resin binder, dry aggregate, and an initiator.

#### *1.4.4 Bituminous Materials*

Bituminous (asphaltic) materials are sometimes used for partial-depth spall repairs on concrete pavements or other surface distress problems. However, they do deteriorate rapidly and are considered only temporary repairs.

#### *1.4.5 Joint Sealants*

Sealant materials are typically used in joint and crack sealing applications. The purpose is to minimize infiltration of surface water and incompressible materials into the joint or crack (ACPA, 1991; FHWA, 1990; ERES, 1992). Sealants also reduce dowel bar corrosion potential by inhibiting the incursion of de-icing chemicals. Required sealant characteristics differ for different joint types (ACPA, 1991). A sealant for a tied longitudinal joint does not need to be as elastic as one for a transverse joint. This is because tied joints undergo virtually no movement (ACPA, 1991). However,

most longitudinal joints in older rigid pavements are not tied. Transverse joints undergo larger movements, which induce larger states of stress and strain within a sealant than typically found in a longitudinal joint; therefore, the sealant used in transverse joints must be capable of handling these stresses to perform over the range of expected joint movement.

Joint sealants are either liquid or preformed. Liquid sealants depend on long-term adhesion to the joint face for successful sealing. Preformed compression seals depend on lateral rebound for long-term performance. Sealant properties necessary for long-term performance depend on the specific application and the climatic environment of the installation. A detailed description of sealant materials can be found in Chapter 4 of this report.

#### *1.4.6 Dowel Bars and Tie Bars*

Dowel bars are smooth, round bars that act as load transfer devices across pavement joints. Dowel bars are typically placed across transverse joints or cracks. Tie bars are deformed bars (i.e., rebar) or connectors that are used to hold the faces of abutting rigid slabs in contact. Tie bars are typically placed across longitudinal joints. Further details regarding dowel bars and ties bars can be found in the Caltrans Standard Plans under the heading “Pavement Technical Guidance” on the Caltrans website: <http://www.dot.ca.gov/hq/oppd/pavement/guidance.htm>.

### **1.5 DESIGN CONSIDERATIONS**

When properly designed, constructed, and maintained, concrete pavements are expected to last for a very long time. Factors that should be carefully thought out during design and construction include traffic applications and their impacts to the pavement, environment conditions, future maintenance and rehabilitation or windows of opportunities for conducting such activities, traffic control during construction, and project staging.

#### *1.5.1 Traffic*

Pavements are designed and constructed to withstand the stresses and strains caused by repeated wheel loads that will be imposed over the course of the design life and beyond. Therefore, it is quite important to have a good knowledge of expected traffic loading on a roadway. Proper structural design of a pavement relies upon developing an accurate forecast of future axle loadings. Details on traffic analysis and rigid pavement structural design can be found in the Caltrans Highway Design Manual (Caltrans, 2004c).

#### *1.5.2 Environment*

There are primarily two major environment-related factors that affect the performance of rigid pavements: temperature and moisture. For pavements located in areas with a cold winter, the effect of freeze-thaw will also impact pavement performance, since the freeze-thaw cycles can cause stresses in a pavement due to variation in temperatures. To address climatic effects, Caltrans has developed a pavement climate map which can be found in Caltrans Highway Design Manual, Topic 615 or at the Caltrans website: <http://www.dot.ca.gov/hq/oppd/hdm/hdmtoc.htm#hdm>.

#### **Temperature**

The variation of temperature causes the slabs to expand or contract. As ambient temperatures change throughout the day, the temperature of concrete pavement also changes. This temperature cycling creates a temperature gradient in the slab, i.e., a difference in temperature between the top and bottom of the slab. As the slab tries to respond to these temperature differences, it is resisted by the weight of

the slab, the support of the base and subgrade, and any restrained edge conditions, which results in the development of intermittent and continuously changing slab stresses. During the day, the temperature at the top of the slab is greater than the temperature at the bottom of the slab, while at night the opposite is true. The temperature gradient causes the slab to curl downward (daytime) or curl upwards (nighttime and early morning), either of which can induce high stresses in the concrete. Depending on the time of day, these curling or warping stresses can either add to or subtract from the effect of the load-induced stresses.

### **Moisture**

Variations in moisture content from the top to the bottom of the slab can cause warping stresses to develop in PCC pavements. Generally, when the top of the slab is drier than the bottom, it causes the pavement to warp upward as a result of a moisture gradient. When these movements are resisted by the weight of the slab, subgrade support, and end conditions, stresses in the slab develop.

### **Other Factors**

There are other key stresses that can develop in concrete pavements that affect performance. Among these are drying shrinkage stresses, which are due to the volume change due to water loss during curing and resistance from the subgrade as it shrinks. Temperature shrinkage stresses are another type of stress occurring in concrete pavements, and these develop because of the resistance of the subgrade to the expansion and contraction of the concrete slab as it responds to daily temperature changes. Dowel bar bearing stresses are also important to the performance of the pavement, particularly in the development of joint faulting.

#### *1.5.3 Windows of Opportunity*

As illustrated in Figure 1-1, pavements deteriorate under traffic loads and with time. There are periods in a pavement's life during which pavement preservation is an economical option. Pavement preservation should be considered early on in the life of a pavement when it is still in relatively good condition. Pavement restoration should be considered when the pavement exhibits distresses like faulting, cracking, or poor ride quality due to structural deficiencies. If the pavement condition is allowed to deteriorate without any proactive maintenance, the windows of opportunity to keep it in good condition with least expense will be lost. After a favorable window of opportunity has passed, pavement preservation is no longer appropriate since the pavement has deteriorated and a more expensive rehabilitation measure should be considered.

The concept of windows of opportunity can also be applied to a specific treatment. The specific treatment is generally selected based on the pavement condition, distress type, extent and severity of distress(es), and economics. The effectiveness of a treatment is largely dependent on the right time when the treatment is applied. The windows of opportunity for a specific treatment can be defined by trigger and limit values on key distresses. Trigger values define the point when the treatment can still be viable and appropriate. Likewise, limit values define the point when the treatment is not likely to be effective. A structural bearing capacity assessment is also appropriate to find out if any serious structural deficiencies exist before applying a pavement preservation measure. Assuming the load bearing capacity of the pavement is still adequate, the period between the trigger and limit values defines the window of opportunity where the treatment is likely to be most effective and economical. Guidelines on trigger and limit values for various treatment strategies are provided in Chapter 3 of this report.

#### 1.5.4 Traffic Control

Adequate traffic control must be provided during field work, both for safety and the successful completion of the project. Traffic control should be in place before work forces and equipment enter the roadway or the work zone. Typical traffic control includes construction signs, construction cones and/or barricades, flag personnel, and/or pilot cars to direct traffic flow. Details on traffic control may be found in the Caltrans Traffic Manual (Caltrans, 1996) or at the website:

<http://www.dot.ca.gov/hq/traffops/signtech/signdel/trafficmanual.htm>.

#### 1.5.5 Item Codes

Caltrans uses item codes along with estimated item quantities to develop project construction costs. An item code is a six digit code used to describe a specific item or activity in a project. For example, item code 193118 is used for concrete backfill and item code 066074 is used for traffic control. Each item code has an appropriate unit of measure. Concrete backfill is measured in cubic meters while traffic control is quoted as a lump sum. The engineer must determine what work items and/or activities are expected in the project and develop estimated quantities for bidding purpose. Caltrans Standard Materials and Supplemental Work Item Codes can be found at the following web site:

[http://i80.dot.ca.gov/hq/esc/oe/awards/#item\\_code](http://i80.dot.ca.gov/hq/esc/oe/awards/#item_code).

For each treatment type discussed in this guide (joint and crack sealing, diamond grinding, dowel bar retrofit, and isolated partial and full depth concrete repair), typical item codes are provided in the corresponding chapters.

## 1.6 KEY REFERENCES

ACPA, 1991. *Design and Construction of Joints for Concrete Highways*, American Concrete Pavement Association, Portland Cement Association, TB-010.0D, Arlington Heights, IL, 1991.

ACPA, 1998. *Guidelines for Partial-Depth Spall Repair*, American Concrete Pavement Association, TB003.02P, 1998.

Caltrans, 1996. *Caltrans Traffic Manual*, Sacramento, CA, 1996.

Caltrans, 1999. *Standard Specifications*, California Department of Transportation, July 1999

Caltrans, 2004a. *Slab Replacement Guidelines*, Sacramento, CA, January 2004.

Caltrans, 2004b. *Interim PCC Pavement Rehabilitation Guidelines – Pavement Tech Notes*, Caltrans, Sacramento, CA, Revised July 28, 2004.

Caltrans, 2004c. *Highway Design Manual*, Caltrans, Sacramento, CA, September 2006.

Caltrans, 2006. *Update of Section 90: Portland Cement Concrete, Standard Specifications*, Caltrans, 2006.

- ERES Consultants, Inc., 1992. *Techniques for Pavement Rehabilitation*, Federal Highway Administration, 1992.
- FHWA, 2001. *PCC Pavement Evaluation and Rehabilitation Reference Manual*, National Highway Institute Course No. 131062, Federal Highway Administration, October 2001.
- FHWA, 2003. *Distress Identification Manual for the Long-Term Pavement Performance Program*, Publication No. FHWA-RD-03-031, FHWA, June 2003.
- FHWA, 2005. *Memorandum on Pavement Preservation Definitions*, FHWA, September 12, 2005.
- Galehouse, L., J. Moulthrop, and R.G. Hicks, 2003. *Principles of Pavement Preservation*. TR News, Transportation Research Board, September-October, 2003.
- Patel, A.J., Mojab, C.A.G. and Romine, A.R., 1993. *Materials and Procedures for Rapid Repair of Partial-Depth Spalls in Concrete Pavements - Manual of Practice*, Strategic Highway Research Report No. SHRP-H-349, National Research Council, Washington, D.C., 1993.
- PCA, 1992. *Design and Control of Concrete Mixtures*. Engineering Bulletin EB001.13T. Portland Cement Association, Skokie, IL, 1992.
- Rao, C., E.J. Barenberg, M.B. Snyder, and S. Schmidt, 2001. *Effect of Temperature and Moisture on the Response of Jointed Concrete Pavements*, Proceedings, Seventh International Concrete on Concrete Pavements, Orlando, FL, 2001.
- Smith, K.L. et al, 1991. *Innovative Materials and Equipment for Pavement Surface Repair – Final Report*, Volume 1 and II, Strategic Highway Research Report No. SHRP-M/UFR-91-504, National Research Council, Washington, D.C., 1991.
- Stahl, Kirsten, 2006. *PCC Pavement Preservation and Maintenance*, Presented at the Southern California Pavement Preservation Conference, April 25-26, 2006, Diamond Bar, California.
- Van Dam, T. J., M. J. Wade, K. D. Smith, and L. L. Sutter. 2000. *Guideline III - Treatment, Rehabilitation, and Prevention of Materials-Related Distress in Concrete Pavements*. FHWA Project No. DTFH61-96-C-00073. Federal Highway Administration, McLean, VA, 2000.

*Disclaimer*

*The contents of this guide reflect the views of the authors who are responsible for the facts and accuracy of the data presented herein. The contents do not necessarily reflect the official views or policies of the State of California or the Federal Highway Administration. This guide does not constitute a standard, specification, or regulation.*

## **CHAPTER 2 SURFACE CHARACTERISTICS**

This chapter identifies the important surface characteristics for pavements such as smoothness, texture, friction, and noise and discusses ways of achieving high levels of these important characteristics in pavements. Other desirable characteristics of durability (or longevity) and aesthetics are also addressed. In the broadest sense, roads exist to serve the traveling public. Nationwide surveys of customer satisfaction (FHWA, 1996) as well as many state-sponsored surveys show that the traveling public is interested in pavement condition and seeing those conditions improved. Other concerns include maintaining safety, addressing congestion by constructing permanent rather than temporary repairs, and doing repairs in a timely fashion.

Customer satisfaction is at the heart and soul of successful pavement preservation programs. From project selection to treatment selection, a good maintenance program will benefit the road users. Smoother and safer roads, faster maintenance and repairs, and the need for fewer repairs over a network of roads are logical outcomes of a pavement preservation program.

### **2.1 IMPORTANT SURFACE CHARACTERISTICS**

Owners of pavements are interested in having pavements possess the following surface characteristics:

- **Ride Quality** – The public demands safe, quiet pavements with a smooth feeling ride. A recent FHWA survey (1996) indicates ride quality to be the most important feature to users of our pavements.
- **Safety** – Users expect the pavements they operated on to be safe. They should offer good texture and surface friction, be free of surface defects, provide contrast for lane markings, minimize splash and spray, and minimize glare.
- **Noise** – Agencies are becoming increasingly aware of the importance of quieter pavements, particularly in urban areas. Reduced pavement noise results in a decreased need for noise barriers and reduced impacts to adjacent neighborhoods.
- **Durability** – Agencies and private owners of pavements want surface layers to withstand the detrimental effects of traffic and environment for their expected surface course lives.
- **Aesthetics** – Users of pavements are also concerned with the appearance of the pavement surface. Patches and other surface irregularities in the surface indicate the pavement are not durable and often result in roughness or safety problems.

### **2.2 RIDE QUALITY**

Distresses commonly found in California's concrete pavements can generally be grouped into three categories: joint deficiencies and cracking, surface defects, and miscellaneous other distresses. All of

these impact the ride quality of the pavement. The distresses commonly found in concrete pavements were discussed in detail in Chapter 1.

### 2.2.1 Definitions

Smoothness is defined as “deviations of a surface from a true planar surface with characteristic dimensions that affect vehicle dynamics, ride quality, dynamic load and drainage” (FHWA, 2004). Pavement smoothness is probably the single most important surface characteristic from the standpoint of the traveling public. Rough and uneven pavements adversely affect driver safety, fuel efficiency, ride quality, and vehicle wear and tear. Rough surfaces also negatively impact pavement durability. Because of the public’s focus on smoothness, any improvements in both initial and long-term smoothness of a roadway should lead directly to greater customer satisfaction.

### 2.2.2 Measuring Smoothness

Several techniques have been used to measure ride or smoothness. Much of the information in this section is a summary of the FHWA documents (Budras, 2001; FHWA, 2004; ACPA, 2006a).

The profilograph has commonly been used to measure the longitudinal profile of a concrete pavement. Its principal use has been for construction control of pavements. Profilographs have successfully been used for construction quality control and assurance on thousands of miles of pavements over the last several decades. In the mid-1980's, computerized data collection was introduced to record and analyze the pavement’s surface profile. With most states using profilographs for measuring smoothness, the profile index became a standard index for smoothness measurement in construction specifications.

Two basic types of profilographs evolved: the California and the Rainhart type profilographs. Profilographs are relatively inexpensive, simple to operate and maintain, and provide a trace of the pavement surface that users can easily understand. Both types can be manually operated by one person at walking speed; however, because of its wheel linkage, it can not be used for high speed network pavement smoothness data collection. Support wheels on the California type profilograph have varied in number from four to twelve, with systems in many States using twelve wheels. These wheels are attached to the ends of a 25-foot (7.6 m) long truss and mounted on a multiple axle carriage that includes four wheels spaced 17 inches (432 mm) from the truss centerline and two wheels spaced 17 inches (432 mm) on the opposite side of the truss centerline. The support wheels are commonly spaced at 2.7-foot (0.82 m) intervals and positioned near the ends of the truss, resulting in an overall profilograph span of approximately 33 feet (10 m). The Rainhart profilograph, however, is no longer in widespread use.

With the advent of non-contact, lightweight profilers, the profilograph has become most suited to retest short, defective pavement sections for verifying the correction of these defects. Bridge profilographs are also highly suited to bridge deck testing, as those projects require only a short profile distance. Figure 2-1 illustrates the two different types of profilographs.

For many years, network pavement smoothness data were obtained with vehicles instrumented with road meters, called by several generic names including: "response-type road roughness measuring systems" (RTRRMS's). RTRRMS's operate at highway speeds, so lane closures are unnecessary. These devices can be mounted on a passenger vehicle, light truck, or special trailer. The RTRRMS measure the response (bounce) of the vehicle to the road smoothness; it is therefore not a true measurement of smoothness. Included in this category of equipment are devices that measure the relative axle-body motion and devices that measure the acceleration of the axle or the vehicle body.



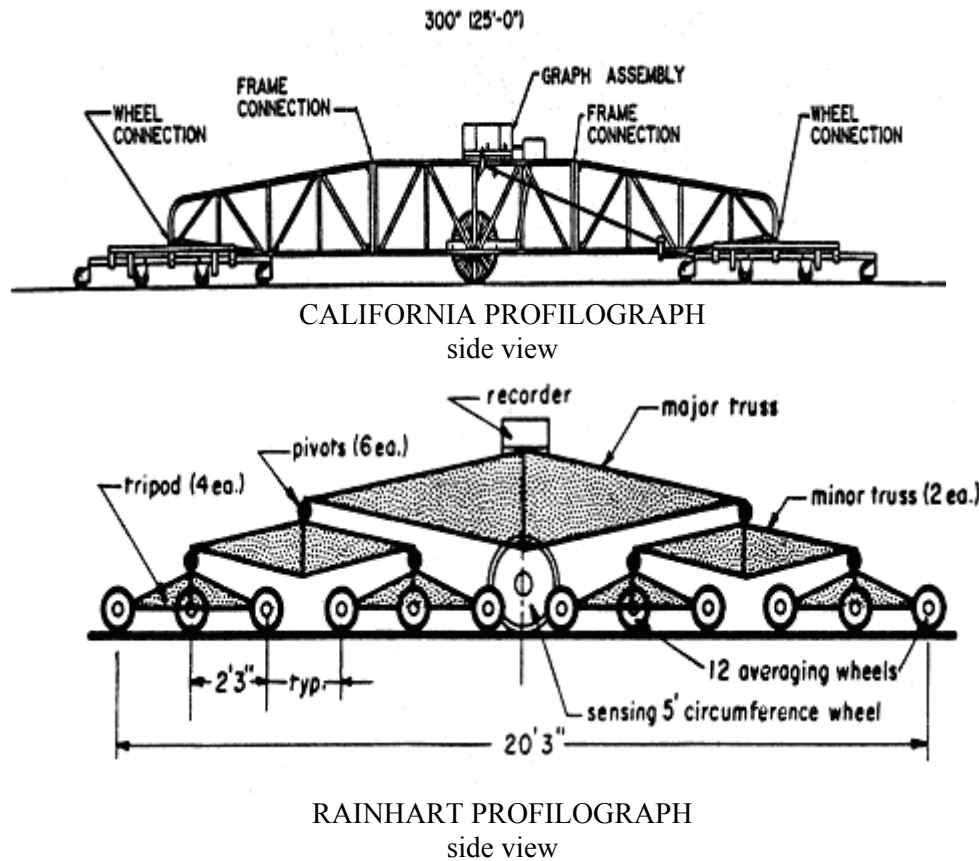
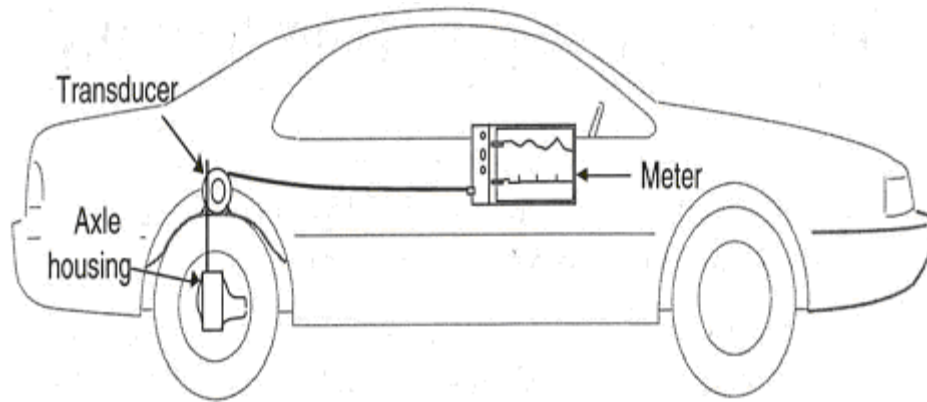

Figure 2-1 Profilographs for measuring roughness (Budras, 2001)

A decade or more ago, the most widely used RTRRMS device in the United States was the Mays Ride Meter. This device determines the smoothness of the roadway by measuring the displacement between the axle housing and the body of the host vehicle or trailer. This device actually measures the relative motion of the sprung mass system in response to traveled surface smoothness where the mass is supported by the automobile-type suspension and tires.

Road meters such as the Mays Ride Meter were devised to be cheap, rugged, and easy to use. However the fact that a response-type system depends on the dynamics of the host vehicle has several negative aspects. Smoothness measuring methods have been shown to be unstable with time. Measurements made today with road meters cannot be compared with confidence to those made several years ago. Also, smoothness measurements have not been transportable. Road meter measurements made by one system are seldom reproducible by another.

In spite of these and other problems associated with response-type meters, they have been in use for the past 50 years, and even with the advent of non-contact profilers a few agencies still use the Mays Road Meter. One reason this device has been in use for so long is that it has convinced engineers that this profiling method has produced meaningful pavement smoothness measurements. Figure 2-2 illustrates the Mays Ride Meter.



A passenger vehicle with a Mays Ride Meter

Figure 2-2 Response-Type Road Roughness Measuring System – Mays Ride Meter (Budras, 2001)

Profiling devices are quite common for network pavement data collection; however, they are not designed for project level quality control. They measure and record the longitudinal profile in one or both wheel tracks. In the USA, inertial type profiling devices are commonly used. Devices in this category of equipment include the original K. J. Law Profilometer (now marketed by Dynatest) and the South Dakota profiling device.

Inertial profilers are capable of measuring and recording road surface profiles for network use at speeds between 10 and 70 mph (15 and 110 kph). Profilers measure and compute the longitudinal profile of the pavement through the creation of an inertial reference system by using accelerometers placed on the body of the measuring vehicle. Relative displacement between the accelerometers and the pavement surface is measured with a non-contact light or acoustic measuring system mounted with the accelerometer on the vehicle body.

Operation typically requires a two-person crew (Caltrans only uses one person to operate), one as a vehicle driver and the other as a system operator. The entire system is mounted in a full size van. The profile computer, data recording, and other system components are all contained in the vehicle. A profiler contains sensors for measuring road surface profile.. With several sensors mounted on the vehicle or using rotating sensors, rut depth can be measured. Accelerometers establish the reference plane for the profiler system's measurement by measuring the vertical accelerations of the vehicle body. The distance traveled by the system is measured with a distance encoder. This is usually a pulse type distance measuring device which is mounted to the front or rear wheel of the vehicle.

Profile signal processing is performed by a digital computer mounted in the vehicle. Profile computations are performed in real time as the vehicle is driven down the road. Interface between the user and the profiler test system is provided through a system terminal and printer. Pavement profile data points are taken every inch of travel. The program for rut depth computes and stores average rut depth taken every 100 feet (30.5 m) from data taken every 3 feet (1.6 m), or at other selected points.

Vehicle response simulation programs for smoothness index calculations are available with the profiler test system. The selected roughness index is normalized to read inches per mile or meters per kilometer and is printed out on the system printer. The cost of a non-contact inertial profiler varies with the level of precision. The laser is the most precise device. . The South Dakota type device contains ultrasonic sensors.. It measures the profile in one wheel path.. The laser device is available from several manufacturers, including Dynatest ([www.dynatest.com](http://www.dynatest.com)), SSI

([www.smoothroad.com](http://www.smoothroad.com)), Ames ([www.amesengineering.com](http://www.amesengineering.com)) and International Cybernetics ([www.internationalcybernetics.com](http://www.internationalcybernetics.com)), and others. Figure 2-3 illustrates this type of device.



Photo of road roughness profiler van

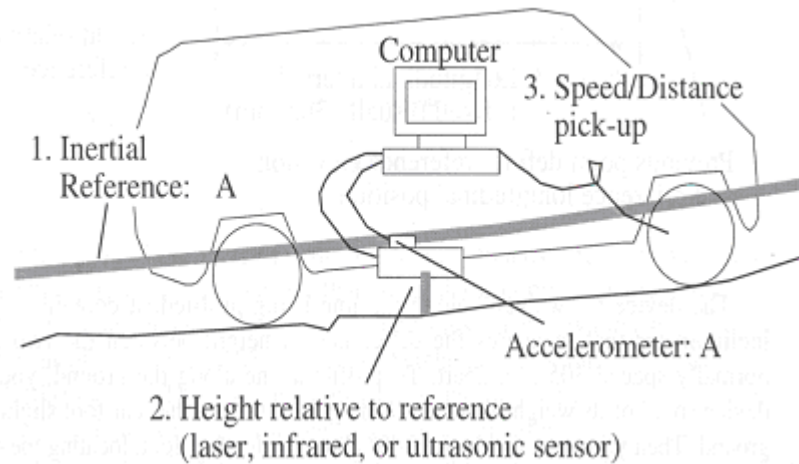

Schematic of road roughness profiler van

Figure 2-3 Road Roughness Profiling Device (Budras, 2001)

A new generation of lightweight, non-contact profilers has emerged for construction quality control and acceptance purposes. They are much smaller and lighter than the network level profilers, providing the benefit of use immediately after hot-mix asphalt (HMA) construction and much sooner than would be possible with the network level devices on new portland cement concrete (PCC) pavements. However, they have operating speeds ranging from 8 to 25 miles per hour (13 to 40 km/hr), which makes it impractical for high speed, large roadway network data collection. These non-contact profilers require a one or two person operation and are battery powered. The basic system consists of an accelerometer, a non-contact sensor distance measuring instrument, a graphic display, and an IBM-compatible PC with a graphics printer.

Inputs from the accelerometer and non-contact sensor are fed into the system's on-board computer, which calculates and stores a user selected smoothness index. The on-board computer is capable of storing up to 13,000 miles (21,000 km) of data. Pavement profile data points, taken every inch, are stored as profile points. The results can be viewed on-screen or output to the printer. The

longitudinal measurements are independent of variations in vehicle weight, speed, extremes in temperature, sunlight, wind, and pavement color or texture. The program can also calculate different smoothness indices using the same data.

Some of the emerging profilers include a Lightweight Profiler, manufactured by Dynatest ([www.dynatest.com](http://www.dynatest.com)); Lightweight Inertial Surface Analyzer (LISA), manufactured by Ames Engineering ([www.amesengineering.com](http://www.amesengineering.com)); and the Lightweight Profiler, manufactured by International Cybernetics Corporation ([www.internationalcybernetics.com](http://www.internationalcybernetics.com)). Surface Systems & Instruments Inc. ([www.ssi-profile.com](http://www.ssi-profile.com)), and Pathway Services, Inc. ([www.pathwayservices.com](http://www.pathwayservices.com)) also manufacture lightweight profilers. Figure 2-4 illustrates these types of devices.



non-contact lightweight profiler



non-contact sensor

Figure 2-4 Non-Contact Lightweight Profiling Devices (Budras, 2001)

The Multi-Laser Profiler (MLP) as shown in Figure 2-5, provides a vehicle mounted system that automatically collects integrated road condition data by recording laser profiles of the road surface at highway speeds. It is very useful for monitoring large road networks. The speed of operation ranges from 18 miles (30 km) to 75 miles (120 km) per hour. The MLP requires one or two person operation and comes with an onboard computer system and a range of software for data acquisition and analysis tasks. It measures IRI and, rut depth in both longitudinal and transverse profiles. The inertial sensors compensate for suspension and tire characteristics. It surveys up to approximately 370 miles (600 km) of road per day at intervals as close as 2 inches (50 mm) for smoothness and , rutting..

Portable laser profiler systems contain many other sensors and modules not required for pavement smoothness measurements. These optional features of the system include a global positioning system, a road alignment data and digital mapping system, and voice defect logging which allows an operator to log road defects while driving. These optional features provide framework data for asset management. Trigg Industries, Inc. ([www.triggindustries.com](http://www.triggindustries.com)), and Pathway Services ([www.pathwayservices.com](http://www.pathwayservices.com)) are among the manufacturers of the MLP. Smaller, less expensive portable devices, such as lightweight profilers, are better suited for quality control in road construction.



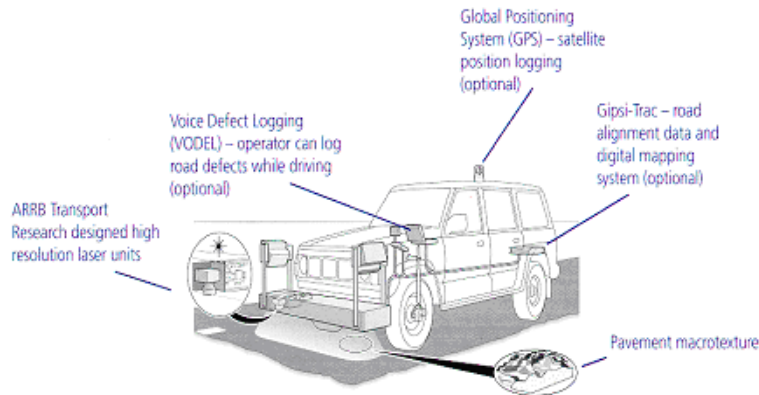

Figure 2-5 Multi-laser Profiler Vehicle (Budras, 2001)

An emerging automated portable laser profiler measurement system is the ROSAN. ROSAN stands for Road Surface Analyzer. Originally designed by FHWA, the ROSAN device serves as a vehicle mounted portable system for measuring longitudinal pavement profile depth at highway speeds, preferably over 30 miles (50 km) per hour. This system is suited for measurement of texture and smoothness. The ROSAN system relies on software to register these measurements. The ROSAN test system requires a vehicle with a step bumper. The entire package, excluding the notebook computer, fits in a wheeled protective case (see Figure 2-6). The ROSAN can be purchased as a complete system from Surfan Engineering and Software.



Figure 2-6 ROSAN System (Budras, 2001)

Caltrans is currently moving from profile index (PI) to IRI. All data submitted to Caltrans using profilograph or profilers must be electronic format according to CTM 526.

### 2.3 TEXTURE

The information in this section comes mainly from ACPA (2000, 2002, 2006a). The work by Neal et al (1978) and Henry (2000) was also used to develop these sections.

### 2.3.1 Definitions of Surface Texture

It is well known that pavement surface texture influences many different tire-pavement interactions, including wet-weather friction, tire-pavement noise, splash and spray, rolling resistance, and tire wear (Henry, 2000). Overall pavement surface texture includes the contributions of many surface features with different combinations of texture depth (amplitude) and feature length. These features include the contributions of aggregate texture and gradation, pavement finishing techniques, and pavement wear, to name just a few. Different texture characteristics (i.e., combinations of texture depth and wavelength) have different effects on tire-pavement interactions. Therefore, it is important to be able to classify pavement texture in a way that is useful in interpreting the effect of pavement surface texture on pavement performance characteristics.

The following *categories of pavement surface characteristics* have been established based on their amplitude (depth) and wavelength: *microtexture*, *macrotexture*, *megatexture*, and *unevenness (roughness)*. Each of these categories is described below, and the specific influence of each category on tire-pavement interaction is illustrated in Figure 2-7. It should be noted that practicing pavement engineers and contractors generally do not consider unevenness (roughness) to be a traditional component of surface texture, but it is clearly a pavement surface characteristic that does influence pavement ride quality and may contribute to user annoyance and perceptions of noise.

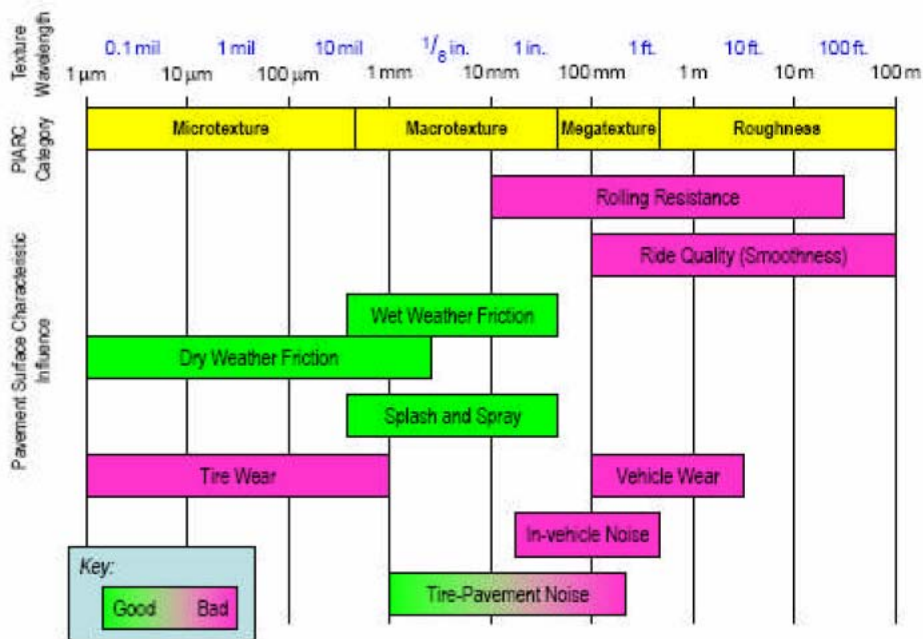

Figure 2-7 Illustration of PIARC pavement surface characteristic classifications and their impact on pavement performance measures (ACPA, 2006a)

**Microtexture** is defined as texture having wavelengths of 0.0004 in to 0.02 in (1 μm to 0.5 mm) and vertical amplitudes less than 0.008 in (0.2 mm). In concrete pavements, this very fine texture is typically contributed by the fine aggregate (sand) in the mortar. Good microtexture is usually all that is needed to provide adequate breaking friction on dry JPCP pavements at typical vehicle operational speeds and on wet JPCP pavements when vehicle speeds are less than 50 mph (80 kph). When higher vehicle speeds are expected, both good microtexture and macrotexture are generally required to provide adequate wet pavement friction. Microtexture is not generally considered to be a factor in the development of splash and spray or pavement noise.

**Macrotexture** refers to texture having wavelengths of 0.02 in to 2 in (0.5 mm to 50 mm) and vertical amplitudes ranging from 0.004 in to 0.8 in (0.1 mm to 20 mm). Macrotexture plays a major role in the wet weather friction characteristics of pavement surfaces, especially at higher vehicle speeds. Therefore, pavements that are constructed to accommodate vehicles traveling at speeds of 50 mph (80 kph) or faster require good macrotexture to help minimize hydroplaning. For concrete pavements, macrotexture is most commonly produced through small surface channels, grooves, or indentations that are intentionally formed in the plastic (wet) concrete or cut into hardened concrete to allow water to escape from beneath a vehicle's tires. In addition to providing wet weather friction, macrotexture is the pavement surface characteristic that has the strongest impact on tire-pavement noise and splash and spray. The impact of macrotexture on pavement friction and noise (both interior and exterior) is strongly influenced by the type of surface texture selected (e.g., transverse tining, longitudinal tining, turf drag, exposed aggregate, etc.) and its design details (e.g., width, depth and spacing of surface grooves, regularity of spacing, direction of texture, etc.). Figure 2-8 illustrates the difference between microtexture and macrotexture through a series of drawings of different combinations of these two pavement surface characteristics.





SURFACE		Scale of Texture	
		Macro (Large)	Micro (Fine)
A		Rough	Harsh
B		Rough	Polished
C		Smooth	Harsh
D		Smooth	Polished

Figure 2-8 Differences between Macrotexture and Microtexture (Shahin, 1994)

**Megatexture** comprises texture with longitudinal wavelengths of 2 in to 20 in (50 mm to 500 mm) and vertical amplitudes ranging between 0.004 in to 2 in (0.1 mm to 50 mm). This level of texture is typically the result of poor construction practices, local settlements, or surface deterioration. Megatexture can cause vibration in tire walls, resulting in in-vehicle noise and some external noise as well. Megatexture also adversely affects pavement ride quality and can produce premature wear of the vehicle suspension (i.e., tires, shock absorbers and struts). It is rarely measured or considered directly; it is defined primarily to provide a continuum between macrotexture and unevenness (roughness).

**Unevenness or Roughness (Smoothness)** is defined as surface irregularities with wavelengths longer than the upper limit of megatexture (>20 in [500 mm]). Wavelengths in this range have an impact on vehicle dynamics, ride quality, and surface drainage. Unevenness is generally attributed to the environment (i.e., temperature and moisture effects) and/or poor construction practices and

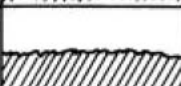
deformations in any pavement layer that have been induced by vehicle loads. Unevenness does not significantly affect tire-pavement noise.

### 2.3.2 Techniques to Create Texture

Surface textures in concrete pavements are usually made during construction by dragging various materials or tools across the fresh concrete (ACPA, 2000). This imparts a continuous series of undulations or grooves in the surface before the concrete hardens. The spacing, width and depth of the grooves affect surface friction, skid resistance, and tire/road noise. The purpose of surface texture is to reduce wet-weather accidents caused by skidding and hydroplaning.

Over the past several decades, there have been several shifts in the types of textures used. For city streets and local roads where speeds are low, burlap drag or broom surfaces are typical. The most common texture on high speed roads remains transverse tining; however a shift is underway to longitudinal tining which results in lower tire-pavement interface noise, both in the vehicle and along the roadway.

#### **Drag Textures**

Until the mid-1960s, new concrete pavement texturing was achieved primarily through shallow texturing techniques, such as a burlap drag, belting, or brooming. A 1969 report stated that 60 percent of the highway departments used burlap drag, and 12 percent specified either a burlap drag or a broom finish. More recently developed drag-type textures include longitudinal brushing and artificial turf drag. Each is described below.

***Burlap Dragging.*** Burlap drag texturing is created by dragging moistened, coarse burlap across the surface of the pavement, typically creating a very shallow longitudinal texture (typically 0.008 inches [0.2 mm] deep) with actual texture depth varying with burlap coarseness, concrete mix design, and finishing conditions.

***Broomed Surfaces – Transverse and Longitudinal.*** Broomed surface textures are created by dragging a hand broom or mechanical broom along the surface of the pavement, creating shallow surface ridges with texture depths ranging from 0.008 to 0.012 in (0.2 to 0.3 mm). Broomed textures may be constructed either longitudinally or transversely.

Like burlap drag textures, broomed surface textures are constructed easily and inexpensively and are relatively quiet, but may not provide adequate wet weather friction at high speeds unless combined with other features. However, if measures can be taken to ensure adequate friction and improved wear resistance, it should be possible to continue using these techniques on many lower speed facilities.

***Longitudinal Plastic Brushing.*** This process consists of a longitudinal burlap drag followed by longitudinal dragging of a plastic bristled brush. The resulting texture is deeper than those described previously (having a mean texture depth of 0.03 to 0.04 in [0.7 to 1.0 mm]). A minimum of 30 percent siliceous sand is typically specified for the concrete mixture to provide a satisfactory microtexture. It has been reported that surfaces constructed with this texture have friction characteristics similar to those of porous asphalt friction courses, and successful installations in Spain have shown this technique to be effective at providing good friction characteristics while minimizing tire-pavement interface noise. However, data are not available to compare wet weather accident rates between this type of texture and others.



**Artificial Turf Dragging.** Artificial turf drag surfaces are created by dragging an inverted section of artificial turf along the plastic surface of the concrete pavement. Early versions of this process produced textures that were similar to those produced by burlap dragging and longitudinal brooming, with typical texture depths of 0.03 to 0.04 in [0.7 to 1.0 mm]. Like the other shallow texturing techniques, early turf drag textures commonly resulted in quiet pavements, but there were still concerns regarding wet weather skid resistance, particularly for high-speed facilities. The Minnesota DOT has used this method since 1999. Because the resulting surface texture offers good wet weather friction and is quiet (compared to other concrete surfaces), artificial drag is now the sole method used in Minnesota (ACPA, 2000). A wet weather study is currently underway by MnDOT which should provide more information on the benefits of this texture type.

### **Tined Textures**

The recognition of the need for improved pavement friction in the early 1970s led to rapid changes in pavement texturing. By the mid-1970s, the most common texturing practices often featured a shallow texturing technique (such as burlap dragging) in combination with deeper transverse grooves produced by drawing a “tining head” (typically a rake-like structure with long, thin metal teeth) across or along a plastic concrete surface to produce a pattern of relatively shallow grooves.

Tined textures can be produced using hand tools or automated equipment within a paving train. The resulting surface grooves or tining marks provide channels (similar to tread grooves on a tire) through which water can escape the tire-pavement contact patch, thereby allowing better contact between the tire and pavement surfaces and reducing hydroplaning potential.

Transverse tining (often preceded by a longitudinal drag texturing) is produced by drawing the tining head across the pavement surface, perpendicular to the flow of traffic. It has proven to be an economical approach for consistently providing durable, high-friction surfaces on new PCC pavements. Caltrans uses longitudinal tining to produce grooves parallel with the centerline. The tining device (section 40-1.10 of the standard specs) shall be operated within 5 inches, but not closer than 3 inches of the pavement edge. The longitudinal tining produces a quieter pavement.

The durability of transversely tined surfaces is related mainly to the quality of the concrete (including the quality of the coarse and fine aggregates) and the spacing and depth of the tine marks. Tine marks that are spaced too closely have a higher potential for spalling under traffic and snow removal operations, which can lead to reduced surface friction. For example, it has been noted that concrete pavements with tine marks spaced uniformly at 0.5 in (13 mm) center-to-center are less durable than pavements with wider tine mark spacing. Experience suggests that transverse tining can provide adequate surface friction characteristics for 30 years or longer when good construction practices and high-quality materials are used (and when there is minimal exposure to studded tires and tire chains). While these deeper transverse texture patterns have greatly improved the wet weather friction characteristics of concrete pavements, they have also been associated with tire-pavement interface noise with objectionable tonal qualities, i.e., a “whine.”

Researchers have learned much about the characteristics of tining and their effects on both surface friction and noise. The sounds produced by the interaction of tires and transversely tined pavements are strongly correlated with the width, depth, and spacing of the tine marks. Typical pavement texturing heads have tines that are about 0.12 in (3 mm) wide, and they are set up to produce texture depths of 0.12 to 0.24 in (3 to 6 mm).

Recent research has led to the development of non-uniform (often called “random”) transverse tine spacing patterns that eliminate this “whine” while longitudinally tined pavements do not produce strong tonal sounds.

### **Diamond Grinding**

Diamond grinding can also be used to create surface texture. This technique is gaining wider acceptance nationwide and is to-date the quietest surface available for concrete pavements. The reader is referred to Chapter 5 of this document for further details on diamond grinding.

#### *2.3.3 Measurement of Surface Texture*

Research has shown that pavement surface texture characteristics can strongly affect both vehicle operations and the surrounding environment by impacting both surface friction and ambient sound levels (noise). As a result, much attention has recently been focused on the direct measurement of surface texture characteristics, especially macrotexture, which is the characteristic most strongly associated with many aspects of pavement-tire friction and sound emissions.

There are several different methods for measuring surface texture, but their results cannot generally be compared directly (although correlations and conversion equations have been developed). Some of the most commonly used measures and measurement methods are described in the following. A brief summary of current surface texture measurement practices in the United States is included below.

**Mean Texture Depth (MTD).** The mean texture depth (MTD) is a measure that is determined using the traditional *volumetric* method (commonly referred to as the “sand patch” test or ASTM E 965). The volumetric method originally required the use of a special tool to spread a specified volume of specially graded Ottawa silica sand (passing the No. 50 sieve, but retained on the No. 100 sieve) on the pavement in a circular motion (see Figure 2-9). In recent years, the use of Ottawa silica sand (Figure 2-10) has been replaced with manufactured glass spheres because the glass spheres spread more uniformly than the Ottawa sand.



Figure 2-9 Photo of original “sand patch” test using Ottawa sand and spreading tool (Hoerner and Smith, 2002)



Figure 2-10 Photo of volumetric texture depth (“sand patch”) test equipment with glass beads and a hockey puck (Wambold and Henry, 2002)

The MTD is calculated by dividing the known volume of sand by the average of four equally spaced diameters of the roughly circular sand patch. Acceptable levels of MTD vary widely among highway agencies and often depend upon expected vehicle speed and other factors. For example, it is recommended that PCC surfaces have an average MTD of at least 0.03 in (0.8 mm), with a minimum of 0.02 in (0.5 mm) for any individual test, to achieve adequate surface friction.

**Mean Profile Depth (MPD).** Advances in laser technology and computational power have led to the development of systems that measure pavement longitudinal profile at highway travel speeds. The data from these systems can be used to compute the mean profile depth (MPD). The MPD is computed by analyzing 4-in (100-mm) segments of the collected profile data. Each segment is divided in two and the average of the highest profile peaks in each half is computed. The MPD is then computed as the average of all individual segment peak averages. It is believed that the MPD is the best parameter for estimating macrotexture for the prediction of wet pavement friction.

MPD can also be measured using the Circular Texture Meter (CTMeter), a portable device (shown in Figure 2-11) introduced in 1998 that uses a laser to measure the profile of a circle with a circumference of 35 in (890 mm). The circular profile is then divided into 8 arc segments of 4.4 in (111 mm) and the mean depth of each arc segment is computed according to standard ASTM practices (ASTM E 2157). The MPD is most accurately estimated when all eight segment mean depths are averaged to produce a single value at each test location. Excellent results have been observed using this method, even on grooved pavements.

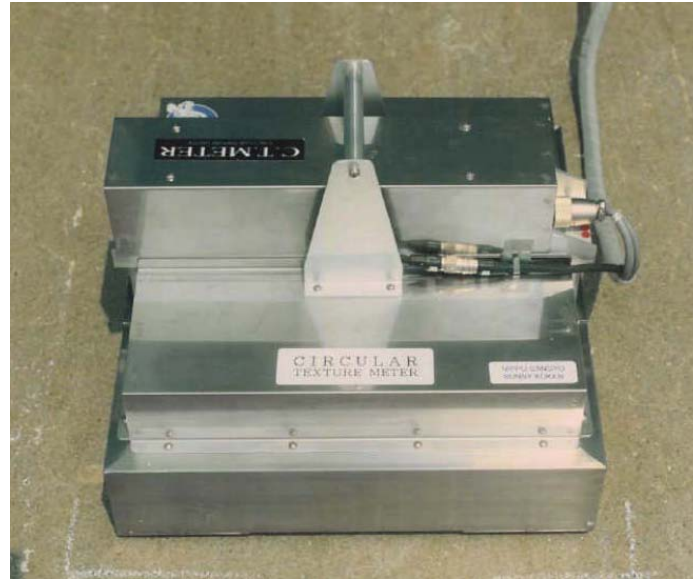

Figure 2-11 Photo of Circular Texture Meter (CTMeter) (Abe et. al, 2001)

The MPD produced using the CTMeter is highly correlated with MTD. Procedures are available in the literature for estimating MTD with MPD (ACPA, 2006b).

**Outflow Time (OFT).** The outflow time (OFT) is measured using the Outflow Meter and is used to provide an indication of pavement surface macrotexture characteristics. The Outflow Meter consists of a transparent vertical cylinder that rests on a rubber annulus placed on the pavement, as shown in Figure 2-12. A valve at the bottom of the cylinder is closed and the cylinder is filled with water. The valve is then opened and the time required for a specified volume of water to flow through the system (as indicated by a specified fall in water level within the cylinder) is measured and called the outflow time (OFT). ASTM Standard E 2380-05 provides standard procedures for determining outflow time.



Figure 2-12 Photo of Outflow Meter in use (Wambold and Henry, 2002)

### 2.3.4 Summary

Pavement surface texture influences many different tire-pavement interactions, including wet weather friction, tire-pavement noise, splash and spray, rolling resistance, and tire wear. *Microtexture, macrottexture, megattexture and unevenness (roughness)* are the four categories most commonly used to characterize pavement surface texture.

Microtexture has wavelengths of 0.0004 in to 0.02 in (1  $\mu\text{m}$  to 0.5 mm). In concrete pavements, microtexture is typically contributed by the fine aggregate (sand) in the mortar. Good microtexture is usually all that is needed to provide adequate stopping (braking) on dry PCC pavements. Microtexture is not generally considered to be a factor in the development of pavement noise or splash and spray.

Macrottexture has wavelengths of 0.02 in to 2 in (0.5 mm to 50 mm). Macrottexture plays a major role in wet weather friction characteristics of pavement surfaces. In concrete pavements, macrottexture is most commonly produced through small surface channels, grooves, or indentations that are intentionally formed in the plastic concrete or cut into hardened concrete surfaces to allow water to escape from beneath a vehicle's tires. Macrottexture is also the pavement surface characteristic that has the strongest impact on tire-pavement noise and splash and spray.

Megattexture and unevenness have longer wavelengths and greater depth and are usually the result of poor construction practices, local settlement, surface deterioration, or environmental effects. They may result in both noise and loss of ride quality.

Several methods have been used for measuring surface texture, including:

- Mean texture depth (MTD), a measure that is determined using the “sand patch test” (ASTM E 965).
- Mean profile depth (MPD), the computed average of the highest profile peaks measured in 4-in (100-mm) segments of laser-based profile measurement data.
- Outflow time (OFT), the time required for a specified volume of water to flow through a transparent vertical cylinder that rests on a rubber annulus placed on the pavement.

The results of these methods cannot generally be compared directly, although correlations and conversion equations have been developed. Acceptable levels of these measures vary widely and often depend upon expected vehicle speed and other factors. As a result there is no universal standard. It is widely believed that the MPD is the best parameter for estimating macrottexture for the prediction of wet pavement friction.

While the importance of the role of pavement macrottexture in providing adequate surface friction has been increasing in the United States, few states actually measure it and even fewer appear to have minimum macrottexture requirements.

## 2.4 SURFACE FRICTION

### 2.4.1 Background

Pavement texture affects both roadway friction and noise characteristics. While highway users and adjacent abutters are clearly concerned with roadway noise issues, they also deserve roadways that have good surface friction and are capable of providing safe travel.

Pavement surface friction (often referred to in the literature as “skid resistance”) is the force developed



at the tire-pavement interface that resists tire slippage and sliding when acceleration, braking, or when lateral forces are applied. While adequate surface friction often exists on dry pavements, water acts as a lubricant that reduces the direct contact between the pavement surface and the tire. If this film of water becomes sufficiently thick or if vehicle speeds are sufficiently high, tires can lose contact with the pavement surface completely, resulting in a dangerous phenomenon known as hydroplaning (Dahir and Grambling, 1990).

Water on the pavement also contributes to splash and spray. This occurs when standing water on the surface is picked up by vehicle tires and splashed or sprayed into the air. Such airborne water can cause a reduction in visibility of the drivers of vehicles traveling next to or closely behind the vehicle creating the splash and spray. Clearly, the reduction of wet weather accident potential must be a high priority in the pavement design process. However, it must also be recognized that most fatal crashes occur on dry roadways. While frictional characteristics of dry pavements are generally considered adequate under normal driving conditions, improved texture and friction can significantly reduce dry pavement accident rates and their severity by reducing stopping distances.

Thus it is essential that the pavement design process include the selection and design of surface textures that reduce hydroplaning potential and provide improved surface friction, both for wet and dry pavements and, especially, for higher speed roadways in urban areas.

#### 2.4.2 Factors that Affect Pavement Friction

##### **Tire Design and Condition**

The frictional force between the tire and the road surface consists of four primary components: adhesive, deformation, and viscous and tearing forces (ACPA, 2006a). Each of these components is influenced in a different way by factors such as contact stress, sliding speed, temperatures of the tire and roadway surface, properties of the rubber compound used in the tire, texture of the road surface, contamination of the surface, tire tread pattern and wear, and presence of a water film.

It has been suggested that tires that are designed to provide good frictional performance under various conditions (e.g., wet weather or hard cornering) must, by necessity, produce higher amounts of tire-pavement noise. For example, it has been claimed by some that the “open” tread patterns necessary to prevent hydroplaning at high speeds will also cause higher noise levels.

It is clear from this discussion that tire design parameters strongly influence the safety of the traveling vehicle, especially in wet weather. It is also clear that good tire friction characteristics do not necessarily have to result in significantly higher noise levels.

##### **Microtexture and Macrotecture**

The characteristics of pavement texture that affect friction are microtexture (0.0004 to 0.02 in [1  $\mu$ m to 0.5 mm]) and macrotecture (0.02 to 2 in [0.5 to 50 mm]). If both can be maintained at good levels, they can provide improved resistance to skidding on wet pavements. Increasing macrotecture generally reduces the potential for splash and spray and increases skid resistance at higher speeds. Microtexture has a strong influence on friction at lower speeds.

### **Time and Seasonal Effects**

Pavement friction usually decreases with pavement age due to two mechanisms: 1) aggregate polishing under traffic reduces microtexture, and 2) aggregate wear under traffic reduces macrotexture. However there are other seasonal changes (especially in colder climates) that may produce either decreases or increases in pavement friction. For example, winter conditions and winter maintenance operations tend to increase aggregate microtexture, sometimes leading to higher friction measurements in the spring and early summer than in the late summer or fall.

Periodic rainfall can also influence friction test results in almost any climate. Dust and oil that accumulate on pavements during dry periods sometimes mix with test water to reduce measured friction values. This effect is less pronounced when testing is performed shortly after periods of rainfall have flushed the dust and oil from the pavement surface.

### **Hydroplaning**

Hydroplaning is different from skidding on wet pavement. When hydroplaning occurs, the entire tire footprint is separated from the pavement by a layer of water and the pavement surface texture no longer plays a role in the friction process.

When a rolling tire encounters a film of water on the roadway, the water is channeled through the tire tread pattern and also through the surface roughness of the pavement. Hydroplaning occurs when the drainage capacity of the tire tread pattern and the pavement surface is exceeded and the water begins to build up in front of the tire. This build-up creates a water wedge, which produces a hydrodynamic force that can lift the tire off the pavement surface—a condition referred to as “full dynamic hydroplaning.” Since water offers little shear resistance, the tire loses its traction and the driver may lose control of the vehicle.

The potential for hydroplaning increases with increasing water depth and vehicle speed and decreases with increasing tire pressure and tread depth. It has been shown that hydroplaning can occur at speeds of 55 mph (90 km/hr) with a water depth of only 0.08 in (2 mm). Hydroplaning potential is also influenced by roadway geometric factors and pavement surface condition.

Pavement surface texture does not directly influence the potential for hydroplaning. Tests have shown that the hydroplaning speed was the same on grooved and un-grooved surfaces that were flooded to the same depth (ACPA 2006a). Pavement texture and transverse profile influence the amount of water available to cause hydroplaning (i.e., rutted pavements can collect and hold significant depths of water while the very smooth surfaces can have greater effective water film thicknesses than surfaces with significant macrotexture).

Hydroplaning potential can be reduced in many ways. For example, the highway geometry can be designed to reduce the length of the drainage paths to remove water more quickly from the pavement surface. Another technique is to increase the depth of pavement surface texture to increase the water channeling/drainage capacity at the tire-pavement interface. The use of open-graded and porous pavement surfaces has also been shown to greatly reduce the hydroplaning potential of the roadway surface. They allow water to be forced through the pavement under the tire, releasing hydrodynamic pressures.

### 2.4.3 Measurement of Pavement Friction

The assessment of surface friction should be an integral component in the process of monitoring pavement performance. The following is an introduction to the most commonly used measures of pavement surface friction (or skid resistance) and friction measurement devices. A brief summary of current practices for measuring surface friction is also included.

#### Measures of Surface Friction

**Friction Number (FN):** Most agencies in the United States currently measure pavement friction using an ASTM locked-wheel trailer (similar to the one shown in Figure 2-13) using either a standard ribbed or smooth (blank) tire (in accordance with ASTM E 274 or ASTM E 524, respectively). Locked wheel testing devices simulate emergency braking conditions for vehicles without anti-lock brakes. In this procedure, water is applied to the dry pavement in front of the locked-wheel trailer. The friction between the locked tire and pavement surface is generally measured at a speed of 40 mi/hr (65 km/hr). The friction number (formerly referred to as skid number) is computed as 100 times the force required to slide the locked test tire over the pavement surface at the specified test speed divided by the effective wheel load.



Figure 2-13 Pennsylvania DOT E-274 locked-wheel friction tester (Wambold and Henry, 2002)

Friction numbers are reported by the designation “FN” followed by the test speed in mph and the letter “R” if a ribbed tire is used or the letter “S” if a smooth (blank) tire is used. If the test speed is expressed in km/h, the test speed is enclosed in parentheses. For example, if a ribbed tire was used in a locked-wheel trailer test at a test speed of 40 mph (65 km/h), the friction number would be reported as FN40R or FN(65)R (for U.S. Customary and SI units, respectively).

**International Friction Index (IFI).** The International Friction Index (IFI) was proposed in 1992 by PIARC as a method of incorporating simultaneous measurements of friction and macrotexture into a



single index that represents overall pavement frictional characteristics. It is now an approved ASTM standard test (ASTM E1960).

The IFI is dependent on the two most important parameters that describe the skid resistance of a pavement: a speed constant ( $S_p$ ) derived from the macrotexture measurement that indicates the speed dependence of the friction, and a friction number (F60) that is a harmonized level of friction for a speed of 36 mph (60 km/h). One advantage of the IFI is that valid tests can be conducted at any speed, since the F60 value for a pavement is the same regardless of the slip speed used. This allows the test vehicle to operate at any safe speed (e.g., higher speeds on high-speed highways and lower speeds in urban situations). It is believed that the adoption of the IFI will eliminate concerns related to the use of different equipment/procedures and test speeds (Hoerner and Smith, 2002). By using IFI, skid resistance can be related to speed.

### **Common Surface Friction Measuring Devices**

Four basic types of full-scale devices are most commonly used to obtain direct measurements of pavement surface friction: locked wheel, side force, fixed slip, and variable slip testers.

All of the devices listed above can be equipped with tires featuring either a “ribbed” tread (one with longitudinal grooves on the tread surface) or with a “blank” or smooth tread. Ribbed treads have been used widely in the U.S. because they are relatively insensitive to water film thickness, which makes them a good choice for performing a test that would ideally be insensitive to all operational factors (such as water film thickness). The grooves in the standard ribbed tires are much larger than the flow areas provided by typical pavement surface macrotexture. Therefore measurements obtained with ribbed tires are somewhat insensitive to macrotexture and are mainly influenced by microtexture (Henry, 2000). This helps to explain why the use of ribbed tires in friction testing is partially responsible for the sometimes poor correlation between friction test values and highway accident rates. Many studies indicate that standard smooth tires produce friction test results that correlate much better with wet weather accident rates (Henry 2000).

Using smooth test tires generally produces lower friction numbers, which may be one reason why many agencies are reluctant to use them. Either tire can be used to report the IFI, which requires the measurement of macrotexture to adjust the ribbed tire data in determining the friction number, F60.

- **Locked Wheel Devices**

As described previously, locked wheel trailers simulate emergency braking conditions for vehicles without anti-lock breaks by dragging a locked wheel (i.e., a 100 percent slip ratio) on a pavement wetted with a specified amount of water. The slip speed is equal to the vehicle speed. The brake is applied and the force is measured and averaged for 1 second after the test wheel is fully locked. Peak friction can be determined because the force measurement is continuous during the braking process. Locked wheel testers are usually equipped with a self-watering system for wet testing. A nominal water film thickness of 0.5 mm is commonly used (Henry, 2000).

- **Side Force Devices**

Side force testers are designed to simulate a vehicle’s ability to maintain control in curves. They function by maintaining a test wheel in a plane at an angle (the yaw angle) to the direction of motion, while the wheel is allowed to roll freely (i.e., a 0 percent slip ratio). The side force is measured perpendicular to the plane of rotation.

The main advantage to the side force method is that these devices can measure friction continuously through the test section (rather than over 1-second intervals, like the locked wheel devices). It should be noted that the relative velocity is proportional to the sine of the yaw angle, which is usually small. Therefore, these systems produce low-speed measurements even though they can be operated at high speeds. Thus, they tend to be most sensitive to pavement microtexture.

Examples of specific side force testing equipment include the MuMeter (Figure 2-14) and the Sideway force Coefficient Routine Investigation Machine (SCRIM – Figure 2-15), both of which originated in the United Kingdom. The SCRIM averages side force measurements from two wheels that are toed out at an angle of 7.5 degrees. Some SCRIM's are now fitted with laser macrotexture measurement systems to provide a more complete indication of a pavement's surface friction characteristics. The MuMeter was developed mainly for airport use and has seen only limited use on highways in the United States.



Figure 2-14 Photo of Mu Meter (Wambold and Henry, 2002)



Figure 2-15 Photo of SCRIM (Wambold and Henry, 2002)

- Fixed and Variable Slip Devices

The fixed and variable slip methods attempt to detect or operate around the peak friction level to simulate a vehicle's ability to brake while using increasingly more common antilock brakes. Fixed slip devices operate at a constant slip, usually between 10 and 20 percent slip (i.e., the test wheel is driven at a lower angular velocity than its free rolling velocity) while the variable slip devices sweep through a predetermined set of slip ratios, in accordance with ASTM Standard E 1859. Examples of fixed slip devices include the Griptester (Figure 2-16) and SAAB Friction Tester (Figure 2-17). A specific example of a variable slip device is the Norsemeter Road Analyzer and Recorder, ROAR (Figure 2-18). The fixed and variable slip testing devices have not been widely used on highway pavements in the United States and there is no current ASTM standard for fixed slip testing



Figure 2-16 Photo of GRIPTESTER-towed mode (Wambold and Henry, 2002)



Figure 2-17 Photo of SAAB Surface Friction Tester (Wambold and Henry, 2002)



Figure 2-18 Photo of Norsemeter ROAR – Variable Friction Tester (Wambold and Henry, 2002)

- British Pendulum Tester

Another method of measuring pavement friction (or microtexture, indirectly) is the British (portable) Pendulum Tester (BPT), which is described in ASTM E 303. Developed for use as a laboratory test for cores or lab-prepared samples, it can also be used on pavements in the field.

The BPT (shown in Figure 2-19) is operated by releasing a pendulum from a height that is adjusted so that a rubber slider on the pendulum head contacts the pavement surface over a fixed length. Friction between the slider and the pavement surface reduces the kinetic energy of the head, and the reduced kinetic energy is converted to potential energy as the pendulum breaks contact with the surface and approaches its maximum recovered height. The difference between the initial and recovered pendulum heights represents the loss in energy due to friction between the slider and the pavement surface. The BPT is equipped with a scale that measures the recovered height of the pendulum in terms of a British Pendulum Number (BPN). The slip speed of the BPN is very slow (typically about 6 mph), so the BPN is generally believed to correlate most strongly with pavement microtexture. This is useful, because direct measurement of microtexture is difficult. However, recent studies suggest that the BPN is also influenced by macrotexture in some situations.

- Dynamic Friction Tester

The Dynamic Friction Tester (DFT), shown in Figure 2-20, consists of a disk that spins with its plane parallel to the test surface. The use of this apparatus is described in ASTM E 1911. Three rubber sliders are mounted on the lower surface of the spinning disk and can reach tangential speeds of up to approximately 55 mph (90 kph). Water is placed on the test surface in front of the sliders and the test is performed by lowering the spinning disk to the surface of the pavement and then monitoring the torque as the speed of the disk is slowed to a stop by the friction between the pavement texture and the rubber sliders.



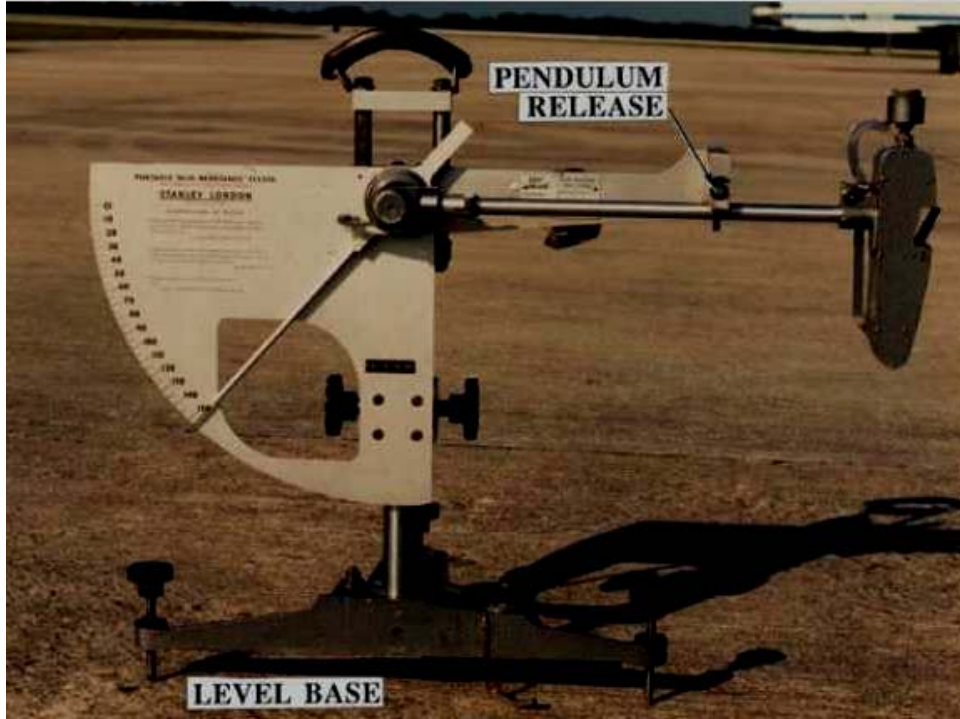

Figure 2-19 Photo of British Pendulum Tester (Wambold and Henry, 2002)



Figure 2-20 Photo of Dynamic Friction Tester (courtesy of Nippou Sango Co, Ltd)  
([www.nippou.com](http://www.nippou.com))

The torque measurement is converted to a friction measurement by determining the slider force required to produce the measured torque and then dividing that force by the weight of the disk and motor assembly. Friction measurements are typically determined at speeds of 12.5, 25, 37.5 and 50 mph (20, 40, 60 and 80 kph). It should be noted that the rotational nature of the DFT test prevents it from distinguishing directional effects of pavement texture (e.g., it will produce the same values for tining performed in the transverse and longitudinal directions).

#### 2.4.4 Current Surface Friction Criteria and Measurement Practices

This section presents a brief summary of current friction criteria and measurement practices.

##### **FHWA**

In 1979, the Federal Highway Administration (FHWA) provided guidance to state and local highway agencies in establishing skid accident reduction programs through Technical Advisory TA 5040.17, “Skid Accident Reduction Program.” This document was superseded in June 2005 by TA 5040.36. Neither document provides specific recommended values for minimum or desirable pavement friction test results. The current applicable technical advisory states that agencies “... should consider many factors including splash and spray, climate, traffic, speed, geometry, conflicting movements, materials and costs, and presence of noise sensitive receptors...” but that “... it is unlikely that one surface type or texturing method will always be the best choice for all projects within a State or jurisdiction ...” because of wide variations in design, materials and maintenance factors.

##### **AASHTO**

The 1976 AASHTO Guide for the Design of Skid Resistant Surfaces is currently being updated under NCHRP Project 1-43 (<http://www4.trb.org/trb/crp.nsf/All+Projects/NCHRP+1-43>). The updated guide is expected to be considered by AASHTO for adoption. It is expected that the updated guide will provide more specific guidance on considering texture and friction during the pavement design process.

New Guidelines for PCC Surfacing Texturing are currently being developed under NCHRP Project 10-67 (<http://www4.trb.org/trb/crp.nsf/All+Projects/NCHRP+10-67>). These guidelines will address the need for adequate friction and for low noise PCC surfaces.

##### **State Highway Agencies**

A 1999 survey of both U.S. and foreign agencies documented current friction measurement practices around the world (Henry, 2000). The survey revealed that only 11 of 42 responding U.S. highway agencies had published minimum acceptable levels for skid resistance. It appears that many highway agencies are reluctant to assign minimum acceptable friction levels for highway pavements due to liability concerns.

In practice, FN4OR values of 30 to 40 have generally been considered acceptable for interstate highways and other roads with design speeds greater than 40 mph (65 km/h). Lower friction numbers have generally been accepted for pavements with low traffic volumes (e.g., average daily traffic of less than 3,000 vehicles) and traffic speeds less than 40 mph (65 km/h). It should be noted that these criteria are based on pavement friction measurements obtained using a ribbed tire. As described previously, the current applicable FHWA technical advisory recommends the use of ASTM E 574

smooth tires for pavement friction testing because they correlate better with wet weather accident rates, therefore different threshold values may be required for FN4OS.

#### 2.4.5 Summary

While highway users and abutters are clearly concerned with roadway noise issues, they also deserve roadways that have good surface friction and are capable of providing safe travel. Highway safety must not be sacrificed in favor of reductions in roadway noise. Pavement surface friction or “skid resistance” is the force developed at the tire-pavement interface that resists tire slippage and sliding when acceleration, braking, or lateral forces are applied. While adequate surface friction often exists on dry pavements, in wet weather water acts as a lubricant that reduces the direct contact between the pavement surface and the tire. Excessive surface water can also cause hydroplaning. Water on the pavement also contributes to splash and spray. It is essential that the pavement design process specifically include the selection and design of surface textures that reduce hydroplaning potential and provide improved surface friction for both wet and dry pavements, especially on higher speed roadways in urban areas.

Tire design and condition (e.g., rubber compound, tread design, wetness and wear) strongly influence vehicle safety, especially in wet weather. Good tire friction characteristics do not necessarily have to result in significantly higher noise levels. The pavement texture characteristics that affect friction most strongly are microtexture (0.0004 to 0.02 in [1  $\mu$ m to 0.5 mm]) and macrotexture (0.02 to 2 in [0.5 to 50 mm]). If both microtexture and macrotexture can be maintained at high levels, they can provide resistance to skidding on wet pavements. Increasing macrotexture also generally reduces the potential for splash and spray and increases skid resistance.

Pavement friction usually decreases with pavement age due to two mechanisms: 1) aggregate polishing under traffic reduces microtexture, and 2) aggregate wear under traffic reduces macrotexture. However there are other seasonal changes, such as winter conditions, winter maintenance operations, periodic rainfalls, etc., that may produce either decreases or increases in pavement friction.

Hydroplaning potential can be reduced in many ways, including the use of increased cross-slope, increased pavement surface texture depth, and the use of open-graded and porous pavement surfaces. Grooving, where used, should be performed in the direction of the predominant pavement surface slope to allow for better drainage.

Several types of devices are commonly used to obtain direct measurements of pavement surface friction. Each has various advantages and applications. Each device can be equipped with tires featuring either a “ribbed” tread (one with longitudinal grooves on the tread surface) or with a “blank” or smooth tread. Ribbed treads are relatively insensitive to water film thickness, which makes them a good choice for tests that are insensitive to operational factors, such as water film thickness. However, ribbed tires are somewhat insensitive to macrotexture and are therefore mainly influenced by microtexture, which partly explains the sometimes poor correlation between friction test values and highway accident rates. Many studies indicate that standard smooth tires produce friction test results that correlate much better with wet weather accident rates.

Most agencies in the United States currently measure pavement friction using a locked-wheel trailer equipped with either a standard ribbed or smooth (blank) tire. Locked wheel testing devices simulate emergency braking conditions for vehicles without anti-lock brakes. Water is applied to the dry pavement in front of the trailer and the friction between the locked tire and pavement surface is

measured. The friction (or skid) number is computed as 100 times the force required to slide the locked test tire over the pavement surface divided by the effective wheel load.

The International Friction Index (IFI) incorporates simultaneous measurements of friction and macrotexture into a single index that represents overall pavement friction characteristics. One advantage of the IFI is that valid tests can be conducted at any speed.

Current and past FHWA documents have provided state and local highway agencies with guidance in establishing skid accident reduction programs, but have not provided specific recommended values for minimum or desirable pavement friction test results. The 1976 AASHTO Guide for the Design of Skid Resistant Surfaces will be updated under NCHRP Project 1-43. It is expected that the updated guide will provide more specific guidance on considering texture and friction during the pavement design process. As of 1999, only 11 of 42 responding U.S. highway agencies had published minimum acceptable levels for skid resistance. Friction numbers of 30 to 40 (40 mph test with ribbed tires) have generally been considered acceptable for interstate highways and other roads with design speeds greater than 40 mph (65 km/h). Lower friction numbers are generally been accepted for pavements with low traffic volumes.

## 2.5 NOISE

Sound is acoustic energy that results from variations in air pressure and density. “Noise” by definition is simply unwanted sound. Noise emitted from vehicles and their interaction with pavements can be attributed to several source categories. Tire-road noise is a major contributor to overall sound levels.

Pavement type and texture contribute to tire-pavement interface noise levels. Pavement texture does not remain constant over time, thus affecting tire-pavement noise levels. Preventive maintenance techniques can be employed to slow down pavement deterioration, which prolongs the quieter characteristics of the pavement. These techniques are discussed in more detail in later chapters.

The issue of quieter pavements has received increasing attention over the past several years. In response, Caltrans has developed a quieter pavement advisory guide and web page containing the latest information and findings on this topic. For more information, reader should visit the web site at <http://www.dot.ca.gov/hq/oppd/pavement/qpavement.htm>.

## 2.6 ACHIEVING DESIRED SURFACE CHARACTERISTICS

The desired surface characteristics (smooth, quiet, and safe ride) are addressed during the construction of the new pavement or the rehabilitation projects. As the pavement wears out, it begins to get rough, loses its surface texture and become noisier. The preventive maintenance techniques discussed in this guide are all intended to improve the overall pavement condition. In reality, only few of the preventive maintenance treatments will actually have an effect on the desirable surface characteristics.

### 2.6.1 Ride Quality

Ride quality or smoothness will be most affected by applying the following treatments:

- Grinding: Diamond grinding can have a significant effect on ride quality;
- Thin Overlays: Thin overlays, either on portland cement or asphalt concrete pavements, can also impact ride quality;



- Spall repair: Spall repair can improve ride quality, but the greatest improvement would probably be obtained when it is done before diamond grinding;
- Isolated Slab Replacement: Slab replacement can improve ride quality, but the greatest improvement would probably be obtained when it is done before diamond grinding.

The use of treatments such as joint resealing or dowel bar retrofit will likely not impact ride quality unless some of the other treatments mentioned above are applied at the same time.

### 2.6.2 Texture and Friction

Surface texture and friction can be improved by grinding or with an overlay. Spall repair, dowel bar retrofit, or slab replacement will not likely improved the overall surface texture of the pavement, which is why they should be done in conjunction with diamond grinding. In fact, joint resealing and crack sealing can result in a loss of surface texture if applied too generously.

### 2.6.3 Noise

For latest information on options to reduce noise, please visit the Caltrans Quieter Pavement Advisory Guide at: <http://www.dot.ca.gov/hq/oppd/pavement/qpavement.htm>.

## 2.7 KEY REFERENCES

- Abe, H, J.J. Henry, A. Tamai, and J. Wambold, 2001. *Measurement of Pavement Macrotecture Using the CTMeter*, TRR 1764, TRB, Washington DC, 2001.
- ACPA, 2000. *Concrete Pavement Surface Textures*, Special Report 902P, American Concrete Pavement Association, 2000.
- ACPA, 2002. *Longitudinal Texture for Smooth and Quiet Ride*, American Concrete Pavement Association, 2002.
- ACPA, 2006a. *Pavement Surface Characteristics: A Synthesis and Guide*, Draft Report, American Concrete Pavement Association, April 2006.
- ACPA, 2006b. *2005 ACPA Profiler Repeatability Tests*, ACPA R & T Update, April 2006.
- Budras, Joseph, 2001. *A Synopsis of the Current Equipment Used fro Measuring Pavement Smoothness*, August 2001.
- Dahir, S. M. and W. L. Gramling, 1990. *Wet-Pavement Safety Programs. NCHRP Synthesis of Highway Practice 158*. Transportation Research Board, Washington DC, 1990.
- FHWA, 1996. *National Highway User Survey*, Federal Highway Administration, May 1996.
- FHWA, 2003. *Alternative Pavement Surfaces May Reduce Roadway Noise*, Public Roads, Volume 66, No 6, May/June 2003.
- FHWA, 2004. *Pavement Smoothness Methodologies*, FHWA-HRT-04-061, March 2004.

- Henry, J.J., 2000. *Evaluation of Pavement Friction Characteristics*, NCHRP Synthesis of Highway Practice 291, Transportation Research Board, 2000.
- Hoerner, Todd E. and Kurt D. Smith, 2002. *PCC Pavement Texturing: Effects on Tier-Pavement Noise and Surface Friction*, FHWA Report, 2002.
- Larson, Roger L., Larry Scofield, and James Sorenson, 2005. *Providing Durable, Safe, and Quiet Pavements*, Proceedings, 8<sup>th</sup> ICCP, Purdue, 2005.
- Neal, B. F., D. E. Peck, James H. Woodstrom, and Don L. Spellman, 1978. *Surface Textures for PCC Pavements*, FHWA-CA-TL-78-14, Caltrans, 1978.
- Rasmussen, R. O., Y. Resendez, G. Chang, and T. Ferragut, 2004, “*Concrete Pavement Solutions for Reducing Tire-Pavement Noise*”, Iowa State University, Center for Concrete Pavement Technology, Ames, IA, 2004.
- Sandberg, U and J.A Ejmont, 2002, “*Tyre/Road Noise Reference Book*”, Informex Ejmont & Sanberg Handelsbolag, Kisa Sweden, ISBN 91-631-2610-9, 2002.
- Shahin, M.Y., 1994. *Pavement Management for Airports, Roads and Parking Lots*, Chapman and Hall, New York, NY, 1994.
- Wambold, J.C. and J.J. Henry, NASA Wallops 2002. *Tire/Runway Friction Workshops: 1993-2002*, Publications TP 14190E, Transport Canada, Montreal, Canada, 2002.
- Wayson, Roger L., 1998. *Relationship between Surface Texture and Highway Traffic Noise*, NCHRP Synthesis of Highway Practice 268, Transportation Research Board, 1998.

*Disclaimer*

*The contents of this guide reflect the views of the authors who are responsible for the facts and accuracy of the data presented herein. The contents do not necessarily reflect the official views or policies of the State of California or the Federal Highway Administration. This guide does not constitute a standard, specification, or regulation.*

## **CHAPTER 3 FRAMEWORK FOR TREATMENT SELECTION**

This chapter discusses key factors to be considered during the strategy selection process for preservation and restoration treatments for jointed plain concrete pavements (JPCP). Treatments for continuous reinforced concrete pavements (CRCP) may be added to this document at a later date. Currently Caltrans does not have a formal selection matrix for preventive maintenance treatments for JPCP pavements. This chapter describes the steps involved in the treatment selection process, including typical methods for assessing existing pavement condition, determining feasible treatment options, and comparing and selecting treatment options. At present, only specific preventive maintenance treatments are included. In the future, other treatments, such as thin hot mix overlays, will be added.

### **3.1 FACTORS TO CONSIDER**

The most important factors to consider during the strategy selection process include structural integrity, ride, skid and distress type. Noise can also be considered as a factor. Chapters 1 and 2 have provided an extensive discussion on these factors. Another important factor to consider is the durability/longevity of a treatment.

#### *3.1.1 Ride*

As indicated, the ride quality is directly related to pavement smoothness which is probably the single most important surface characteristic from the standpoint of the traveling public. A rough pavement not only adversely affects driver safety, fuel efficiency, and vehicle wear and tear, but also negatively impacts pavement durability. Therefore, the key factor for improving the ride quality is to improve pavement smoothness.

#### *3.1.2 Skid*

Skid resistance is a measure of the frictional characteristics of a pavement surface. A pavement with low skid resistance may cause vehicles to slide when the pavement surface is wet. Therefore, maintaining adequate pavement surface friction is important to public traffic safety. The key factor for improving the skid resistance is to improve pavement surface texture.

#### *3.1.3 Noise*

To many motorists, a quieter pavement provides a pleasant driving environment. A considerable number of studies have been devoted to reducing noise caused by tire-pavement interaction. Current information and findings on quieter pavement can be found at Caltrans' website:

<http://www.dot.ca.gov/hq/oppd/pavement/qpavement.htm>.

### 3.1.4 Distress Type

The type of distress on an existing pavement is probably one of the most important factors for the selection of an appropriate strategy. A specific distress may be caused by either single or multiple mechanisms. The key factor to consider during strategy selection is to identify treatments that not only mitigate distress symptoms but also resolve the mechanism(s) that caused the distress in the first place. Durability problems, such as D-cracking (although not found in California's rigid pavements) and alkali-silica reactivity (ASR), are primarily material related. Treatment selection for these types of problems depends on the rate of deterioration.

### 3.1.5 Durability/Longevity

The durability/longevity of a treatment is another important factor to consider. Caltrans' experience has indicated that the estimated lives of joint resealing and crack sealing may range from 4 to 7 years, while diamond grinding may provide estimated lives of 10 to 18 years before major rehabilitation or maintenance is again needed. Dowel bar retrofits, if properly carried out, can achieve estimated lives of 8 to 15 years, while partial or full depth repairs may last 8 to 10 years or longer. It must be noted that the durability/longevity of the treatment is dependent on the underlying structural condition of the pavement, traffic load, and environmental conditions as well as construction practices.

## 3.2 SELECTION PROCESS

There are three steps currently included in the pavement preservation and restoration treatment selection process for flexible pavements, as identified below (Caltrans, 2002; Shatnawi et al, 2006). These processes are also suitable for rigid pavements.

- Assess the existing conditions – these include the identification and cause(s) of pavement distresses and assessment of their conditions, as discussed in Chapter 1 and the desired surface characteristics as discussed in Chapter 2.
- Determine the feasible treatment options – “feasibility” is determined by a treatment's ability to address the functional and structural condition of the pavement while also meeting future needs. Feasibility is not a function of affordability. At this stage of the selection process, the purpose is to determine what treatments might work for a given pavement's structural and functional condition.
- Analyze and compare the feasible options – once feasible options are identified, they are compared in terms of cost, life expectancy, and extended pavement life resulting from the treatment. At this stage, a life cycle cost analysis or other cost effectiveness assessment should be made to evaluate the optimum time to apply the treatment to provide maximum cost effectiveness.

Each of these steps is discussed in the following sections.

## 3.3 ASSESS THE EXISTING PAVEMENT CONDITIONS

The first step of the treatment selection process is to perform an evaluation of the existing pavement condition. This evaluation includes the following processes:

- Review project information from a database and/or available records.
- Conduct visual site inspection of the pavement surface condition, as needed.

- Perform testing (for example, FWD joint testing) on the existing pavement as conditions require.
- Define the expected performance requirements for the treatment.

### 3.3.1 Project Information Review

Reviewing project information serves the following main purposes:

- Provides the qualitative information needed to determine the causes of pavement deterioration, and to develop appropriate alternatives for repairing the deterioration and inhibiting its recurrence.
- Provides the quantitative information needed to assess the rate of deterioration of the pavement and the consequences of delaying or accelerating the application of a given treatment and ,when appropriate, to identify feasible maintenance treatments, to make quantity estimates for the selected treatment (e.g., labor, materials, equipment), and to develop input for performing life-cycle cost comparisons of various treatments.

Table 3-1 provides data items typically needed or helpful for various treatment strategies considered in this document.

Table 3-1 Suggested data item needs for treatment strategies for rigid pavements (FHWA, 2001)

Data Item	Grinding	Load Transfer Restoration	Partial-Depth Repair	Full-Depth Repair
Existing Pavement Structure	X	X	X	X
Original Construction Data	*	*	*	*
Age	*		*	*
Materials Properties	X		*	*
Subgrade				
Climate				
Distress	X	X	X	X
Skid	*			
Accidents	*			
NDT	X	X		*
Destructive Testing/ Sampling	*	*	X	X
Roughness	*			
Surface Profile	X			
Surface Drainage	X			X
Previous Maintenance	*		*	*
Utilities				X
Traffic Control Options	X	X	X	X

**KEY:** X Definitely Needed      \* Desirable      [blank] Not Normally Needed

Possible data sources are:

- Previous design reports;
- Previous construction plans/specifications (new and rehabilitation);
- Materials and soils properties from previous laboratory test programs and/or published reports;
- Past pavement condition surveys;
- Nondestructive testing and, if needed, destructive sampling investigations;
- Maintenance/repair history;
- Traffic measurements/forecasts to aid in estimating remaining service life;
- Environmental/climate studies or regional climatic data;
- Pavement management system reports.

These data may reside in each District office. Caltrans District Materials Engineers can be contacted to obtain the necessary information.

### *3.3.2 Field Distress Survey*

A field distress survey is a very important activity in the process of pavement evaluation and strategy selection. Depending on the size and nature of the project, a field distress survey can be conducted through “windshield” observations, automated surface distress data collection equipment, and/or a detailed distress mapping survey involving lane closures. As part of this activity, information on distress type, extent, and severity, pavement roughness, surface friction, and moisture/drainage problems should be gathered (Caltrans, 2000). In addition, requirements for traffic control options for a detailed field survey and for construction may be assessed during the field visit. Caltrans Maintenance has been developing forms for flexible pavement surface treatment review checklists and pavement evaluation, as presented in Appendix E. These forms need to be modified to include checklists and pavement evaluation for concrete pavements.

### *3.3.3 Field Sampling and Testing*

If needed, field tests on existing pavements may be conducted. The purpose of field testing is to verify and/or quantify the extent and severity of the observed distresses. The type of field testing to be conducted depends on the distresses on the existing pavement and its structural integrity. For example, roughness or profile & macrotexture tests may be required if there is concern about surface smoothness or surface texture; a skid test may be needed if there is concern with loss of skid resistance; deflection tests may be appropriate if there are concerns about the structural capacity of the pavement, the loss of support beneath the PCC slab due to voids, or the loss of load transfer efficiency of the joints.

Field sampling/testing may be required to provide additional information for detailed analysis or for laboratory testing if needed. The purposes of field sampling/testing and lab testing are to adequately characterize the structural characteristics of the existing pavement and to develop input for the selection of most appropriate strategies. Depending on the project requirements, field sampling activities may include pavement coring, augering, field testing using Dynamic Cone Penetrometer (DCP), and/or standard penetration test to measure the in-situ strength of the subgrade soils.

When required, laboratory testing may be conducted to verify, confirm, or quantify field observations from distress surveys or from non-destructive test program and to provide additional insight into the mechanism of the distress or to provide additional information needed for the development of treatment strategies. Examples of information that can be determined from laboratory testing include the following:

- California R-value of an unbound material
- Concrete flexural or tensile strength
- Petrographic testing and analysis for the concrete surface layer
- Resilient modulus of concrete or other materials

The National Highway Institute (NHI) Course No. 131062 (FHWA, 2001) provides an excellent discussion on various field sampling/testing and laboratory testing techniques. It is strongly encouraged that the reader looks into this reference when developing a plan for field sampling/testing and lab testing.

### 3.3.4 Performance Requirements

For rigid pavements, performance requirements vary by the type of treatment applied to the pavement. The treatments currently considered by Caltrans for maintenance include the following:

- Joint resealing and crack sealing. Caltrans makes extensive use of crack or joint sealants in jointed concrete pavements. Asphalt emulsions, fiber and asphalt, rubberized asphalt, and silicone sealants have been used. The estimated lives of these treatments vary from 4 to 7 years depending on where they are applied, existing pavement condition, structural integrity, and traffic levels.
- Diamond grinding. Diamond grinding is used extensively as a maintenance treatment to restore smoothness. Estimated lives of the grinding can be 10-20 years, with an average of about 16 years depending on traffic loads, structural integrity, environmental factors, and overall pavement surface condition.
- Partial or full depth slab repair. This treatment is used to repair performance problems such as spalling. The estimated lives of these treatments vary from 8-12 years.
- Dowel bar retrofit. Caltrans has used dowel bar retrofit as a pavement restoration strategy. This treatment is expected to be used more; however, the pool of candidates in California is considered small due to pavement age and distress levels. When dowel bar retrofits are carried out properly, the estimated lives of this treatment range from 8-16 years. The dowel bar retrofit may be considered as a rehabilitation strategy if the amount of repair is extensive.
- Full slab replacement. Caltrans also replaces isolated full slabs where the slab has exhibited extensive cracking or is unstable. The estimated lives of this treatment may range from 3 to 15 years, highly dependent on overall pavement condition and the quality of the slab replacement project. Full slab replacement should be considered as a rehabilitation strategy if the amount of slabs to be replaced is extensive.

A summary of expected life for various treatments for rigid pavements is provided in Table 3-2. Trigger values for initiating various treatments based on national practices are also provided in the table. Work is currently underway by Caltrans to evaluate the effect of climate and traffic conditions and to develop specific trigger values for these conditions (Shatnawi, et al, 2006). However, proposed trigger values for use by Caltrans are currently based on national values and appropriate adjustments made for the local climate and traffic volume. Estimated costs are provided by Caltrans Maintenance for reference only and could vary from district to district and by the selected treatment for each traffic condition. District Materials Engineers and/or Resident Engineers should be consulted for costs for each treatment used on a specific project.

### 3.4 DETERMINE FEASIBLE TREATMENT OPTIONS

Once the pavement condition has been quantified, test results collected and analyzed to determine that the pavement’s structural condition is adequate, and other available data are reviewed, feasible pavement preservation treatments can be identified. In this context, “feasibility” is determined by a treatment’s ability to address the functional and non-structural condition of the pavement while also meeting any future needs. At this stage of the selection process, feasibility is not a function of affordability. The primary purpose is to determine what treatments may work.

Table 3-2 Proposed trigger values and expected life for various PCC maintenance treatments  
 (Modified from Shatnawi et al, 2006)

Treatment	Trigger (National)	Climate Region <sup>1</sup>				Traffic ADT			Life of Treatment (Year)	Estimated Cost (\$) <sup>2</sup>
		Desert	Valley	Coastal	Mountain	<5000	>5000;<30000	>30000		
Crack Resealing	>1/4 inch	>1/4	>1/4	>1/4	>1/4	>1/4	>1/4	>1/4	4 - 7	\$28k - 42k/ ln mi
Diamond Grinding	Faulting >1/4 inch; Ride 95 in/mile	>1/4 >190	>1/4 >95	>1/4 >95	>1/4 >190	>1/4 >190	>1/4 >125	>1/4 >95	10 - 18	\$30k - 80k/ ln mi
Partial Slab Repair	Surface distress - Patches <1.2 yd <sup>2</sup>	<1.2	<1.2	<1.2	<2.4	<2.4	<1.2	<1.2	8 - 12	\$135 - 270/yd <sup>3</sup>
Isolated Slab Replacement	3rd stage cracking or unstable slabs	Same Trigger Value. For desert, mountain, or ADT<5000, District makes decision to repair.							8 - 12	\$4000 - \$8000/slab
Dowel Bar Retrofit	LTE <60%, Faulting >1/4 inch, Max 10% Cracking	<40 >1/4 20	<70 >1/4 10	<70 >1/4 10	<50 >1/4 20	<50 >1/4 20	<70 >1/4 10	<70 >1/4 10	8 - 17	\$141k – 177k/ln mi

Notes:

<sup>1</sup> For locations of climate regions, see Pavement Climate Map at:  
<http://www.dot.ca.gov/hq/oppd/pavement/guidance.htm>.

<sup>2</sup> Estimated costs were provided by Caltrans Maintenance

A feasible alternative is one that addresses all identified distresses of the pavement (from the various evaluations performed), provides the desired future performance over the life of the treatment, and fits within identified constraints. Some of these constraints may include:

- Construction windows.
- Traffic flow conditions.
- Overhead clearances.
- Right-of-way.
- Funding.

It should be noted that the constraints should be identified, but should not be used to eliminate treatment alternatives from consideration or development unless the constraints indicate the treatment is not feasible.



The information presented in Table 3-3 may be used as a guideline for the selection of feasible treatments. This table is to target distresses commonly found in the California rigid pavement system. The information is general in nature, and is not designed to cover either every possible distress type or treatment alternative. Some of the repair techniques have not been discussed in detail here, but they are mentioned so that appropriate consideration may be given during the treatment selection process, as necessary. In Table 3-3, the restoration techniques are defined as activities that are performed in response to the development of a deficiency or deficiencies that may negatively impact the safe, efficient operation of the pavement. Preservation/preventive techniques are intended to retard future deterioration, and maintain or improve the functional condition of the pavement system (without significantly increasing the structural capacity).

Table 3-3 Rigid pavement distress and related repair/preventive maintenance methods

Distress Type	Preservation Techniques	Restoration Techniques
<i>Structural Distresses</i>		
Transverse Cracking	Joint and crack sealing	Full-depth repair Dowel bar retrofit
Longitudinal Cracking	Joint and crack sealing Slab stabilization	Full-depth repair Dowel bar retrofit
Corner Cracking	Joint and crack sealing Edge joint resealing Slab stabilization	Full-depth repair
2 <sup>nd</sup> /3 <sup>rd</sup> Stage Cracking	Joint and crack sealing Slab stabilization	Full-depth repair Dowel bar retrofit Slab replacement
Spalling	Partial-depth repair Joint and crack resealing Full-depth repair	
Pumping	Joint and crack resealing Slab stabilization	Full-depth repair Dowel bar retrofit
Blow ups	Full-depth repairs	Joint and crack resealing
D-cracking (not common in California)	Partial- or full-depth repair; Joint and crack resealing	
<i>Functional Distresses</i>		
Faulting		Diamond grinding Dowel bar retrofit Slab stabilization Joint and crack resealing Retrofitted edge drains
Ride Quality		Diamond grinding
Settlement		Diamond grinding
Surface Polishing	Diamond grinding Grooving	
Noise	Diamond grinding See Caltrans website for the latest information at: <a href="http://www.dot.ca.gov/hq/oppd/pavement/qpavement.htm">http://www.dot.ca.gov/hq/oppd/pavement/qpavement.htm</a> .	
Scaling	Diamond grinding	
Popouts	Diamond grinding	

Several treatments may be feasible for a given set of conditions. Therefore, efforts should be made to identify as many feasible treatment alternatives as possible for a given project. Once the feasible treatments have been identified, the limitations of each of the options should be taken into account in relation to its suitability in comparison with the other feasible options. Treatment limitations are controlled by such factors as pavement surface deflections, pavement structural condition, roadway curvature, pavement roughness and permeability. With multiple alternatives, advantages and disadvantages of each treatment can be compared. The selection process can be used to rate alternatives against each other on all of the factors deemed important by Caltrans, such as initial cost, life-cycle costs, constructability, expected performance, expected life, and so on.

The American Concrete Pavement Association (ACPA, 1998) has also developed trigger and limit values for jointed plain concrete pavements (JPCP), for jointed reinforced concrete pavements (JRCP), and for continuously reinforced concrete pavements (CRCP). Trigger/limit values for JPCP and JRCP are presented in Tables 3-4 and 3-5 and they may be useful when developing feasible treatment options. However, most of the concrete pavements in California consist of JPCP.

Table 3-4 Trigger and limit values for jointed plain concrete pavements (ACPA, 1998)

Jointed Plain Concrete Pavements (Joint Space < 19.7 ft [6 m])*	Trigger/Limit Values**		
	Traffic Volumes	High (ADT>10,000)	Medium (3000<ADT<10,000)
<i>Structural Measurements</i>			
Low to high severity fatigue cracking (% of slabs)	1.5/5.0	2.0/10.0	2.5/15.0
Deteriorated joints (% of joints)	1.5/15.0	2.0/17.5	2.5/20.0
Corner breaks (% of joints)	1.0/8.0	1.5/10.0	2.0/12.0
Faulting (avg. - inch)	0.08/0.5	0.08/0.6	0.08/0.7
Durability distress (severity)	Medium-High		
Joint seal damage (% of joints)		>25/---	
Load transfer (%)		<50/---	
Skid resistance	Minimum local acceptable level/---		
<i>Functional Measurements</i>			
IRI (inch/mile)	63.4/158.4	76.0/190.1	88.7/221.8
PSR	3.8/3.0	3.6/2.5	3.4/2.0
California Profilograph	12/60	15/80	18/100

\* Assumed slab length = 15 feet.

\*\* Values should be adjusted for local conditions. Actual percentage repaired may be higher if the pavement is restored several times.

Table 3-5 Trigger and limit values for jointed reinforced concrete pavements (ACPA, 1998)

Jointed Reinforced Concrete Pavements (Joint Space > 19.7 ft [6 m])*	Trigger/Limit Values**		
	Traffic Volumes	High (ADT>10,000)	Medium (3000<ADT<10,000)
<i>Structural Measurements</i>			
Medium to high severity transverse cracking (% of slab)	2.0/30.0	3.0/40.0	4.0/50.0
Deteriorated joints (% of joints)	2.0/10.0	3.0/20.0	4.0/30.0
Corner breaks (% of joints)	1.0/10.0	2.0/20.0	3.0/30.0
Faulting (avg. - inch)	0.16/0.5	0.16/0.6	0.16/0.7
Durability distress (severity)	Medium-High		
Joint seal damage (% of joints)		> 25/---	
Load transfer (%)		< 50/---	
Skid resistance	Minimum local acceptable level/---		
<i>Functional Measurements</i>			
IRI (inch/mile)	63.4/158.4	76.0/190.1	88.7/221.8
PSR	3.8/3.0	3.6/2.5	3.4/2.0
California Profilograph	12/60	15/80	18/100

\* Assumed slab length = 33 feet.

\*\* Values should be adjusted for local conditions. Actual percentage repaired may be higher if the pavement is restored several times.

### 3.5 COMPARE THE FEASIBLE OPTIONS

It is likely that several maintenance or repair treatments may be identified as feasible. When comparing these different treatments, thought should be given to the treatment placement cost and the life of the treatment. Additional factors to consider when analyzing and comparing treatment options include: cost effectiveness, traffic level, construction windows or limitations, and other factors, such as weather, curing times or local issues that affect a specific treatment. The most desirable treatment is the one that provides the greatest benefit (whether that benefit is measured in terms of improvement in condition, extension of pavement life, or even, more simply, the life of the treatment) for the lowest life cycle costs. At this point, a life cycle or other cost effectiveness measure should be performed.

#### 3.5.1 Life Cycle Costing

Life-cycle cost analysis (LCCA) is an analytical technique that is built upon principles of economics to evaluate long-term alternative investment options. It is a useful tool for comparing the value of alternative treatments. In the LCCA, all costs associated with a feasible treatment or alternative could be compared based on the present value (PV) or equivalent uniform annual cost (EUAC).

The LCCA typically involves the following steps:

- Establish alternative/treatment;
- Determine analysis period;
- Determine discount rate;
- Determine maintenance/rehabilitation treatment frequencies;
- Estimate both agency and user costs;
- Calculate LCC; and
- Select treatment/alternative.

Caltrans is currently developing a pavement life-cycle cost analysis procedure based on the RealCost model developed by FHWA (FHWA, 1998). A draft user manual has been prepared (Caltrans, 2006). The user manual provides descriptions of the LCCA methodology, the use of the RealCost software, and examples of LCCA. The user manual also includes the following information:

- Typical maintenance and rehabilitation schedule for California;
- Maintenance and rehabilitation cost estimation;
- Maximum queue length estimation;
- State highway traffic hourly distribution;
- Agency construction unit costs (by district); and
- Work zone/traffic inputs determination.

It is anticipated that the development of the LCCA procedure will be completed by the end of 2007. It will then be possible to perform LCCA for various treatments for a variety of conditions.

### 3.5.2 *Compare and Select Options*

Typically, when a pavement preservation treatment/alternative is chosen, the option with the lowest LCC is generally selected. However, there are other factors that should be taken into consideration when making a final decision. These factors include the following:

- Agency policies.
- Overall pavement management of network (policies).
- Provisional (staged) construction.
- Traffic control requirements (safety and congestion).
- Available lane closure time.
- Existing geometric design problems and constraints that may prevent a treatment to be used.
- Right-of-way restrictions that may prevent a treatment to be used.
- Regulatory restrictions.
- Available materials and equipment.
- Contractor expertise and manpower for the location.
- Construction considerations (duration of construction).
- Conservation of materials and energy by using recycled materials.
- Potential climatic issues and/or constraints.
- Performance of the proposed treatment elsewhere under similar conditions.
- Availability of local materials and contractor capabilities.
- Worker safety during construction.
- Incorporation of experimental features.
- Municipal preference, local government preference, and recognition of local industry.
- Project funding and scope.

A simple ranking procedure, using the model described in the FHWA NHI Course 131062 (FHWA, 2001) <http://www.nhi.fhwa.dot.gov/>, may be developed to rate each feasible treatment/option. Factors to be considered in the ranking procedure should include key factors such as initial cost, life cycle cost, expected life of the treatment, user costs, and Caltrans experience with the feasible treatment option, or options. The importance of each factor can be signified by assigning a weighting to it. The weighing value represents the relative importance of a factor in all factors considered and could be on a scale of 1 to 10 or 1 to 100. The weighting can be assigned either by an individual or by groups of managers and other decision makers with a direct knowledge of the project and/or a stake in the outcome.

Each feasible treatment option is then rated independently against the key factors using a uniform scale, such as 1 to 5 or 0 to 100. The highest rating means that a treatment option best meets that criterion. The score or factor is calculated by multiplying the weights for each factor by the rating assigned. The total score for each treatment is the sum of the individual scores. The alternatives are then ranked in order, from the highest score to the lowest. The treatment option with the highest score is then selected. Table 3-6 shows an example of this process.

### 3.6 KEY REFERENCES

- ACPA, 1998. *The Concrete Pavement Restoration Guide-Procedures for Preserving Concrete Pavements*, American Concrete Pavement Association, 1998.
- Caltrans, 2000. *Caltrans Pavement Survey*, Sacramento, California Department of Transportation, California, January, 2000.
- Caltrans, 2002. *Maintenance Technical Advisory Guide (MTAG)*, Web Site: <http://www.dot.ca.gov/hq/maint>, Sacramento, California Department of Transportation, California, April 2002.
- Caltrans, 2006. *Pavement Life-Cycle Cost Analysis: RealCost State User Manual*, Sacramento, CA, June 2006.
- FHWA, 1998. *Life-Cycle Cost Analysis in Pavement Design*, FHWA-SA-98-079, Pavement Division Interim Technical Bulletin, September 1998.
- FHWA, 2001. *PCC Pavement Evaluation and Rehabilitation: Reference Manual*, National Highway Institute Course No. 131062. October 2001.
- Shatnawi, S, R. Marsh, R.G. Hicks, and H. Zhou, 2006. *Pavement Preservation Strategy Selection in California*, Accepted for presentation at the 11<sup>th</sup> AASHTO/ TRB Maintenance Management Conference, Charleston, South Carolina, July 16, 2006.

Table 3-6 Example worksheet of a selection process incorporating multiple selected decision factors and assigned weightings.  
 (FHWA, 2001)

Decision Factor Names ⇨	DECISION FACTORS										Total Score	Rank
	Initial Cost	Life Cycle Costs	Expected Life	Ease of Repairing/Maintaining	Construction Traffic Control	Proven Design in Agency						
Weightings ⇨	25	15	20	15	10	15	10	15			80	1
Alternative 1	60	60	100	80	90	100	90	100	15	15	80	1
Alternative 2	60	60	100	80	90	100	90	100	12	9	80	1
Alternative 3	60	60	70	50	60	40	60	40	12	9	57.5	6
Alternative 4	60	60	70	50	60	40	60	40	7.5	6	57.5	6
Alternative 5	60	40	100	80	100	90	100	90	12	10	76.5	3
Alternative 6	60	80	40	20	40	20	40	20	8	4	45	9
Alternative 7	40	60	40	50	50	30	50	30	3	4	44	10
Alternative 8	70	80	60	50	80	40	80	40	7.5	8	63	5
Alternative 9	100	100	20	20	40	40	40	40	4	4	57	8
Alternative 10	30	60	100	100	100	30	100	30	15	10	66	4

*Disclaimer*

*The contents of this guide reflect the views of the authors who are responsible for the facts and accuracy of the data presented herein. The contents do not necessarily reflect the official views or policies of the State of California or the Federal Highway Administration. This guide does not constitute a standard, specification, or regulation.*

## **CHAPTER 4 JOINT RESEALING AND CRACK SEALING**

This chapter covers joint resealing and crack sealing for jointed plain concrete pavements (JPCP) and addresses both joint sealing and crack filling. This chapter also discusses appropriate selection and use of joint and crack treatments and materials, design considerations, joint preparation, sealant installation, quality and troubleshooting. The emphasis of this chapter is on sealants rather than fillers.

### **4.1 PURPOSE AND DESCRIPTION OF TREATMENT**

The purpose of joint and crack sealing of JPCP is to reduce infiltration of surface moisture and incompressible materials into joints and cracks. Moisture ingress is one of the primary causes of rigid pavement distress and it can infiltrate the pavement structure in a number of ways. Surface water is generally the primary source of moisture in the pavement structure and thus has the greatest impact on pavement performance. Moisture typically reduces subgrade strength and causes loss of slab support due to subbase and subgrade erosion and pumping, which results in pavement settling – faulting at joints and corner breaks. Incompressible materials lock joints open and create excessive pressure on the joint faces that may cause spalling, blowups, buckling, or in extreme cases, shattering of slabs. Whether or not such distresses occur, continued migration of incompressible materials into joints forces the slabs apart, which may lengthen the pavement and push it against adjacent structures, such as bridge abutments, medians, etc.

Joints in rigid pavements are designed and constructed to permit expansion and contraction of the slabs to prevent cracking of the slabs between joints. Typically they are constructed by sawing the concrete to a certain depth shortly after placement. Joints may be transverse or longitudinal and are often sealed during construction and then resealed as needed throughout the life of the pavement. Caltrans does not seal joints during construction, which are generally straight with vertical cut or formed faces.

Cracks in rigid pavements are generally load associated, or due to excessive thermal movement that is not adequately controlled by the joint system. Cracks may be transverse, longitudinal, or angled, especially at slab corners.

There has been considerable debate and research on the issues and benefits of joint and crack sealing and resealing, including timing (during construction, preservation, and/or maintenance), materials, design and application practices, and the relative effectiveness thereof. Findings have generally indicated that properly selected and applied sealants can reduce water damage and enhance pavement durability. Specific factors that influence sealant performance have been identified, including design, materials selection, joint face preparation, and sealant installation. As a result, design, materials, and application techniques have been improved over the last 30 years, which has resulted in improved durability and performance of joint and crack sealants. Most agencies currently require joint sealing and resealing of highway and airfield JPCP for preservation and/or maintenance.



The primary differences between sealing and filling are that higher standards are applied for sealing than for filling. Sealants are typically better quality materials than fillers, and the joints and/or cracks to be sealed receive more thorough preparation than those to be merely filled. For these reasons, long term performance of sealed joints and cracks is usually better than performance of filled joints or cracks.

Joints and cracks may open and close horizontally with temperature and moisture changes and may undergo vertical movements as a result of repeated load applications. In order to determine whether to seal or fill a crack, and what type of material to use, it is necessary to establish whether the crack is working (moving) and whether the movement is horizontal or vertical. Working cracks should be routed, cleaned, and sealed with an appropriate sealant; non-working cracks may be filled.

## 4.2 MATERIALS AND SPECIFICATIONS

There are two primary categories of joint sealant materials for JPCP: liquid and preformed. Liquid materials seal by adhering to the joint or crack faces and are subject to compression and tension. The preformed materials are used for compression seals that operate only in compression and in expansion-type joints.

### 4.2.1 Sealant Properties

The sealant properties needed vary according to the application and location of use. Properties of sealants that have been found critical to long term performance of the sealant material include:

- **Durability:** The ability of the sealant to withstand the abrasion and damage of traffic and site weather conditions, which include exposure to moisture, ultraviolet light and ozone, along with temperature extremes and rates of temperature changes.
- **Extensibility/Modulus:** Extensibility is the ability of the sealant to deform without rupturing and it is related to the strain component of elastic modulus. Low modulus (soft, low stress-strain ratio) sealants are generally more extensible than higher modulus (stiffer) materials, but are more vulnerable to intrusion by incompressibles. Low modulus materials are desirable for achieving long term performance in cold climate locations, but may be too soft for use where traffic is heavy or the climate is hot.
- **Elasticity/Resilience:** Elasticity and resilience are measures of the amount of deformation that is recoverable, i.e., the ability of the sealant to return to its original size and shape after it has been stretched or compressed. High values of elasticity and resilience are desirable and typically indicate good resistance to intrusion of incompressibles. However for some thermoplastic sealants, high resilience and resistance to intrusion may limit extensibility, and trade-offs may be necessary to obtain the desired level of extensibility.
- **Adhesiveness:** Adhesiveness is the ability of the sealant to adhere to joint faces. It is essential to the performance of liquid sealants, but does not apply to performance of compression seals. The condition and cleanliness of the joint or crack faces are critical to achieving adhesion and proper preparation is required for a successful application.
- **Cohesiveness:** The ability of the sealant material to hold together and resist internal rupture or tearing. Cohesive failures are more likely to occur in sealants that have aged or stiffened. (Not applicable to compression seals.)

Other properties to consider include compatibility of the sealant with materials it may encounter, such as backer rods or other sealants, and fuel resistance.

4.2.2 Sealant Types and Specifications

Descriptions of the types of available sealant materials are presented in Table 4-1. The top three types are used by Caltrans and are described in Caltrans Standard Special Provisions 41-200 and 41-210. The remaining products are used by other agencies.

Table 4-1 Sealant descriptions and related specifications

Sealant Type	Specifications	Description
<b>Silicone Joint Sealant*</b>	Caltrans SSP 41-200, SSP 41-210	Low modulus
<b>Asphalt-Rubber Joint Sealant*</b>	Caltrans SSP 41-200, SSP 41-210	A mixture of paving asphalt and ground runner
<b>Backer Rods*</b>	ASTM D 5249	An expanded, closed-cell polyethylene form compatible with the joint sealant
<b>Hot-Applied</b>		<b>Thermoplastic</b>
Polymer and CRM-modified Asphalt	ASTM D 6690, Type II	Flexible at -20°F (-29°C)
Polymer and CRM-modified Asphalt	ASTM D 6690, Type I	Flexible @ 0°F (-18°C)
Elastomeric	ASTM D 3406	
Coal Tar	ASTM D 7116	Jet fuel resistant; PVC now rarely used
<b>Cold/Ambient-Applied</b>		<b>Chemically Curing</b>
<b>Single Component</b>		
Type NS	ASTM D 5893	Non-sag, toolable, low modulus
Type SL	ASTM D 5893	Self-leveling, no tooling, low modulus
<b>Two Components</b>		
Polysulfide	Fed Spec SS-S 200E	Jet Fuel and Jet Blast Resistant
Polyurethane	Fed Spec SS-S 200E	Jet Fuel and Jet Blast Resistant
<b>Preformed Compression Seals</b>		
Polychloroprene Elastomeric	ASTM D 2628	Jet fuel resistant
Lubricant	ASTM D 2835	
<b>Preformed Expansion Joint Filler</b>		
Preformed Filler Material	ASTM D 1751 AASHTO M213	Bituminous, non-extruding, resilient
Preformed Filler Material	ASTM D 1752 AASHTO M 153	Sponge rubber, cork, and recycled PVC
Preformed Filler Material	ASTM D 994 AASHTO M33	Bituminous

\* See Caltrans SSP 41-200 and 41-210 at:

<http://www.dot.ca.gov/hq/esc/oe/specifications/SSPs/2006-SSPs/>

Following are brief descriptions of the different products used:

- **Hot-Applied Thermoplastic:** These represent the first class of liquid sealants developed for use with JPCP. Hot-applied thermoplastic materials are bitumen-based materials, which are typically melted in a double boiler with a hot oil jacket and are applied at temperatures of 350-400 °F (175-205 °C). The different types of thermoplastic sealant materials have varying elastic and thermal properties, but most are designed to withstand changes in width of 20-35%.

Rubberized asphalt materials are widely used and have become the standard because they have a relatively wide working temperature range; most conform to the requirements of ASTM D

6690. Lower modulus rubberized sealants may be engineered for use in colder climates. Asphalt-rubber sealants can deform without tearing under cold conditions when joint and crack openings are widest, and they are resistant to softening and tracking at high ambient and pavement temperatures. They cost less than silicone sealants, and Caltrans experience indicates a typical service life of approximately 3 to 5 years.

Hot applied sealants made with polyvinyl chloride (PVC) and coal tar have been used by some agencies because they are jet fuel resistant, stiff at high temperatures, and bond well to JPCP. Although these two-component materials need only be heated to about 250 °F (120 °C) for application, they must be mixed through a special nozzle and are sticky and difficult to work with. Due to variable field performance and the odor and health issues associated with coal tar, this type of sealant is rarely used.

- **Cold/Ambient-Applied Thermosetting** sealant materials (single and two-component): This family of liquid sealants includes silicones, polysulfides, polyurethanes, and epoxies which generally cure chemically, although some types set by release of solvents. Silicone sealants have been widely used since the 1970's. Thermosetting sealants are single component silicone polymers that are prepackaged and are ready for immediate use with no heating or mixing required. They are suitable for use in a wide range of ambient and pavement operating temperatures, and typically cure relatively quickly. These sealants have good bond strength and flexibility which allow them to be placed thinner than the thermoplastic sealants. Low modulus silicones can readily withstand 100% extension and 50% compression. However 25% to 50% strain is the typically recommended operating range for higher modulus silicones. Two types of silicone sealants are used: self-leveling, which is applied in a single step with no tooling required; and non-self-leveling, which requires a separate tooling operation to stick the sealant to the joint walls and to form a uniform recessed surface. Two-component polysulfide and polyurethane sealants show variable performance, require mixing and curing, and are rarely used.

Thermosetting sealants are expensive compared to rubberized asphalt and other hot-applied liquid sealants. Costs have been reported to be between 4 and 10 times higher, but thinner application, lower equipment costs for application, and increases in asphalt prices may offset some of these differences in material costs. Caltrans experience indicates that silicone sealants have a service life of approximately 5 to 7 years.

- **Preformed Compression Seals:** This type of neoprene seal has been used since the early 1960's, and does not require field heating, mixing, or curing. These seals remain in compression throughout their service life, and perform well over a range of 20-50% in compression. Compression seals are made up of cells that push and hold the sealant against the joint faces; five-celled seals have reportedly provided the most consistent performance in exerting lateral pressure on the joint faces. Caltrans expects compression seals to remain in service for approximately 8-12 years. Failure is typically due to loss of elasticity or loss of compressive recovery (also called compression set), such that the seal no longer pushes against the joint faces. Compression greater than 50% may cause compression set if the cells stick together and interfere with rebound.
- **Preformed Expansion Joint Filler:** These are compressible filler materials for transverse joints that are designed to accommodate relatively large expansions greater than ½-inch (13 mm). They are placed before the sealant material and act as backer rods. They may be made from bituminous materials, sponge rubber, cork, or recycled PVC, and most are classified as non-extruding. No field heating, mixing or curing is required. It is not necessary to remove

these fillers when resealing, although bond-breaking tape is usually placed over the old filler before the new sealant is installed.

- **Backer Rods:** Backer rods are foam materials. Closed cell polyethylene foam is used with cold sealant applications and is moderately compressible. For hot applications, cross-linked polyethylene foam (closed cell, moderately compressible) or polyurethane foam (open-cell, highly compressible) are suitable. Caltrans specifications call for expanded, closed cell polyethylene foam for use with silicone and asphalt-rubber joint sealant. Backer rods are important for installing liquid sealant, to control the quantity, and keep the sealant from flowing out through the bottom. Backer rods also serve as bond breakers to prevent the sealant from sticking to the bottom of the reservoir, which increases stresses within the sealant material that may cause loss of adhesion to the joint faces.

Caltrans Maintenance allows use of a number of commercially available materials for filling joints and cracks. For construction and rehabilitation, Caltrans typically specifies specific types of sealant materials as described in Table 4-1.

### 4.3 PROJECT SELECTION

Joint and crack sealing, resealing or filling may be performed as part of normal preservation, maintenance, or repair and restoration activities for JPCP, or as preparation for a surface treatment or as structural overlay. To protect the pavement structure from entry of water and the openings from entry of incompressibles, Chapter B of the Caltrans Maintenance Manual identifies individual cracks 1/8 inch (3 mm) or wider as candidates for repair (B.02 (B)) along with areas of “extensive finer cracking”. Joint sealing and resealing are also triggered by a minimum 1/8-inch (3 mm) separation. Projects are selected based on the following criteria:

- The base should be sound and the existing structure adequate, with no slab faulting or settlement.
- Joints and cracks 1/8 inch to 1 inch (3 to 25 mm) wide are candidates to be sealed or filled. Openings less than 1/8 inch (3 mm) wide are not treated individually, and different approaches are used for openings wider than 1 inch (25 mm).

Cracks in CRCP should not be filled with crack sealants.

### 4.4 DESIGN CONSIDERATIONS

#### 4.4.1 Material Selection

The first step in the design process is to select an appropriate sealant for the subject project. Factors to be considered include:

- Project environment, including weather and moisture conditions during installation and over the service life of the sealant. Caltrans recommends sealing transverse joints in freeze-thaw areas to prevent build-up of incompressibles from de-icing treatments. Colder climates require lower modulus sealants than hot climates.
- Type of roadway (Interstate or state highways) and corresponding traffic characteristics including traffic volumes and percentage of heavy trucks – severe conditions will require more durable sealants and/or more frequent replacement.

- Joint type: Transverse or longitudinal weakened plane or contact joint. Transverse joints require more elastic sealants than do longitudinal joints. Caltrans does not seal contraction joints during construction.
- Joint spacing: Caltrans currently uses relatively short random patterned transverse joint spacing which limits PCC thermal movement and moisture warping. This also reduces the potential for mid-slab cracking. Transverse joint spacing is staggered at intervals of 12, 15, 13, and 14 feet (3.7, 4.6, 4, and 4.3 m) (Caltrans Pavement Tech Notes October 2004 “Concrete Pavement Design Overview”). Use of short JPCP slabs limits the stresses on and in the joint sealant.
- Expected performance and cost effectiveness.
- Availability of materials.

If suitable for intended use and site conditions, Caltrans recommends using a sealant that will last the longest. Caltrans has Standard Special Provisions (SSPs) for three types of sealants (Table 4-1) from which the engineer may choose. Two are liquids—*asphalt-rubber* and *silicone*—which are typically used with backer rods in or next to existing pavement. The other type is preformed compression seals that are used for new joints where the saw cut faces are smooth and parallel, such as replacement of adjacent slabs. Caltrans does not use compression seals for resealing JPCP because variable conditions of in-place joint faces have caused problems in the past.

Use of preformed expansion joint fillers is now limited to locations in and at the ends of bridge deck pavements or adjacent to other structures. Use of dowel bars has effectively eliminated the need for expansion joints in Caltrans jointed plain concrete pavements (JPCP).

Contraction (weakened plane) joints typically experience the largest horizontal and vertical movements, and corresponding stresses. Vertical movements are caused by load stresses, changes in temperature (slab curling) and moisture (warping). Horizontal movements are primarily due to changes in pavement temperature and moisture content, subject to frictional restraint at the slab-subbase interface.

#### 4.4.2 Joint Resealing

Joint resealing in JPCP consists of removing and replacing an existing joint sealant. Joint resealing should be performed when the existing sealant material exhibits distress that indicates it cannot fulfill its intended function, and before the adjacent JPCP is severely damaged. It is often performed along with other pavement restoration activities including spall repair, slab repairs, grinding, etc. Missing or extruded sealant, loss of bond between the sealant and joint face (adhesion loss), tears within the sealant (cohesion loss), hardening/loss of flexibility, weed growth, embedded incompressibles and/or related spalling along the joint are signs of distress that should be considered when selecting the appropriate sealant for joint resealing. Performance may indicate whether a different type of sealant should be substituted. Caltrans uses asphalt-rubber or silicone sealants for joint resealing, each of which provides a range of properties and service lives for a variety of conditions.

The optimum time of the year to perform joint resealing is in the spring or the fall, when installation temperatures are moderate and cracks are likely to be near the middle of their expected range for expansion and contraction. This reduces the potential for the crack sealant or filler to be extended or compressed too much when temperatures increase or decrease after installation.

#### 4.4.3 Filling

Tied longitudinal joints that exhibit little movement may be candidates for filling rather than sealing.

#### 4.4.4 Special Considerations

**Non-uniform Joint Cracking:** For new pavements, it is not unusual for only about one in seven to one in four (14 to 25%) of the joints to crack initially. This is because initial shrinkage cracking of JPCP typically occurs at intervals of about 40 to 150 feet (12 to 45 m), depending on concrete properties, thickness, underlying frictional restraints, and weather conditions at and after placement. Joints between the initial crack locations may take weeks or even months to crack, although the spacings between the random patterned saw cuts are relatively uniform at 12 to 15 feet (3.7 to 4.6 m). Therefore, shrinkage and thermal movements are concentrated at the initially cracked joints rather than uniformly distributed. The resulting initial joint openings are often much wider than the intermediate cracks and remain so over the life of the pavement. This can be seen by substituting the longer lengths between cracked joints in Equation 4-1 for the lengths between saw cuts, which will increase the maximum joint opening,  $\Delta L$ .

**Expansion/Isolation Joints:** When resealing expansion/isolation joints, only the sealant material above the preformed expansion joint filler is removed. The filler is left in place and a bond-breaking tape is placed over it to separate the new sealant from any old sealant that may have been absorbed by the filler. For ease of installation, the width of the tape should be at most 1/8-inch (3 mm) narrower than the width of the joint.

**Resealing Contraction (Weakened Plane) Joints Located Near Expansion/Isolation Joints:** Contraction joints located within about 100 feet (30.5 m) of existing expansion/isolation joints present some special problems. When the expansion joint closes, it allows neighboring contraction joints to open wider than similar joints located farther away. These wider contraction joints may require more extensible sealant, and it may be necessary to use wider backer rods or wider preformed compression seals to insure an adequate seal.

**Existing Lane/Shoulder Joints:** Studies (including Barksdale and Hicks, 1979) indicate that up to 80% of the surface water that enters a pavement gets in through the lane/shoulder joint. Therefore, proper sealing of this joint is critical to long term pavement performance. When both the traffic lane and the shoulder are concrete, the joint between them is no different than a centerline or tied longitudinal joint and sealing presents no special issues.

However joints between rigid pavement lanes and bituminous shoulders can present major problems for sealant performance. The differences between concrete and hot mix asphalt thermal and structural properties tend to cause differential vertical movement, which may manifest as settlement or heaving of the shoulder. Vertical movement may be larger than horizontal movement. Reservoir widths should be increased to one inch (25 mm) or greater, and depths should be equal to the width. Highly extensible liquid sealants that can adhere well to both concrete and hot mix asphalt are recommended for this application, including asphalt-rubber and specially formulated silicone sealants. Cracks and other defects on the flexible shoulder should be repaired before placing sealant.

Caltrans Maintenance Manual Section B.09 indicates that joints between rigid pavement and flexible shoulders should be filled with a mixture of emulsion and rejuvenator and “topped off with sand.” Adequate drainage should be provided to avoid moisture damage to the emulsion mixture.

#### 4.4.5 Reservoir Design for Joint Resealing

##### Liquid Sealants

Reservoir design for joint resealing includes selection of sealant reservoir dimensions and sealant configuration. The size of the reservoir is critical to sealant performance, and it is important to consider future needs for resealing and limit the width accordingly if possible. Caltrans Standard Plan P20, Concrete Pavement—Joint Details presents reservoir dimensions and tolerances for liquid sealants with backer rod and for compression seals for new transverse and longitudinal weakened plane joints and for retrofit transverse and longitudinal joints.

However joints in existing pavements are subject to movement, wear, and damage due to traffic and weather. Preparing the joints for resealing often includes saw cutting and reshaping the reservoir to accommodate the selected type of sealant.

The standard method of estimating average maximum horizontal transverse joint opening due to change of PCC temperature for reservoir design purposes is presented below in Equation 4-1 (Darter, 1977) and applies to doweled and non-doweled joints. However this approach does not consider or calculate vertical movement.

$$\Delta L = C L (\alpha \Delta T + \epsilon) \quad (\text{Eq. 4-1})$$

where:

$\Delta L$  = Maximum joint opening, in (mm).

$\alpha$  = Thermal coefficient of contraction for PCC, typically  $5$  to  $6 \times 10^{-6}$  in/in/°F ( $9$  to  $11 \times 10^{-6}$  mm/mm/°C).

$\epsilon$  = Drying shrinkage coefficient of the PCC, typically  $0.00005$  to  $0.00025$  in/in (mm/mm).  
For resealing projects,  $\epsilon = 0$ .

$L$  = Joint spacing, in (mm).

$\Delta T$  = Temperature drop, °F (°C) = temperature at placement minus the lowest mean minimum monthly temperature.

$C$  = Subbase/slab friction resistance adjustment factor ( $0.65$  for stabilized subbase,  $0.80$  for granular subbase,  $1.0$  for subgrade soil).

Joint spacing is an important factor in Eq. 4-1; the wider the spacing, the greater the length change. The resulting  $\Delta L$  does not apply to every joint, as opening width varies with variations in material properties, restraint conditions, and initial cracking order. Some studies (Morian, Suthahar and Stoffels, 1999) indicate that Equation 4-1 may underestimate the opening width of transverse joints; this may be a function of the amount of initial joint cracking, treatment (sealing or filling) thereof, and site-specific environmental factors.

Equation 4-1 does not apply to tied construction joints and longitudinal joints, including PCC shoulder joints, because the tiebars restrict joint movement. Tied joints generally move very little and openings are relatively narrow, so sealant for longitudinal joints may not require as much extensibility as for transverse joints. However, tied centerline and shoulder joints of roadway pavements do require sealing because they are usually aligned perpendicular to the pavement drainage slope and are exposed to surface water flow.

Determination of the appropriate minimum saw cut width for the joint reservoir is based on the percent elongation that the sealer must accommodate. The joint width,  $W$ , should be sufficient to limit cold weather elongation within the typical design range of 20%; other values may apply for different



materials. Equation 4-2 is derived from an equation developed by Evans, Smith, and Romine in 1999 based on limiting sealant elongation.

$$W_{init} = \frac{100(M_{max})}{\%E_{max}} \quad (\text{Eq. 4-2})$$

where:

- $W_{init}$  = Joint width at the time of sealant placement
- $M_{max}$  = Equivalent to  $\Delta L$  computed in equation 4-1, the maximum joint opening movement caused by change of PCC temperature
- $\%E_{max}$  = Estimated elongation, percent.

A more conservative approach is to assume that a joint between two slabs may be called upon to take the total movement of both slabs, in which case the maximum joint opening,  $M_{max}$ , is assumed to be  $2(\Delta L)$  (Evans, Smith, and Romine, 1999).

### Shape Factor for Liquid Sealant Reservoirs

The width of the joint and the depth of the backer rod define the shape of the sealant. The shape factor is the ratio of in-place sealant depth to width, as illustrated in Figure 4-1. The shape factor is critical to successful long-term performance of liquid sealants. As PCC pavements expand and contract, the cross-section of the sealant changes in response. If the shape factor is not appropriate, the resulting stresses at the sealant/PCC interface and strains within the sealant become excessive and damage or failure can result. Shape factor recommendations are based on the stress-strain characteristics of the respective types of liquid sealants. For asphalt-rubber sealants, the optimum shape factor is 1; for silicone sealants, a shape factor of 0.5 is recommended. However some low modulus silicone sealants permit shape factors of 2.0 or slightly higher. Shape factors of one or less create lower stresses in the joint sealant than factors greater than one. Use of appropriate shape factors promote sealant adhesion and cohesion.

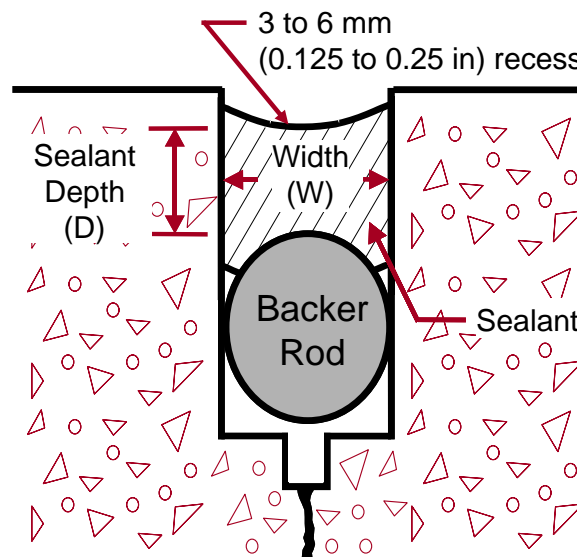

Figure 4-1 Illustration of sealant shape factor (FHWA, 2004)

### Liquid Sealant Configurations

There are three primary configurations for liquid joint sealant applications: recessed, flush-filled, and overbanded. Figure 4-2 shows examples of each. Recessed and flush-filled are the most widely used. However, flush-filling has some potential for extrusion during hot weather and is not appropriate for silicone sealants. Overbanding of asphalt-rubber materials presents issues with abrasion, pull-out, ride, and appearance, and silicone sealants should not be overbanded. Caltrans SSPs for joint sealing and resealing and Standard Plans call for a recess of 3/8" ± 1/16" (10 mm ± 2 mm) below the pavement surface which serves well for both asphalt-rubber and silicone sealants.

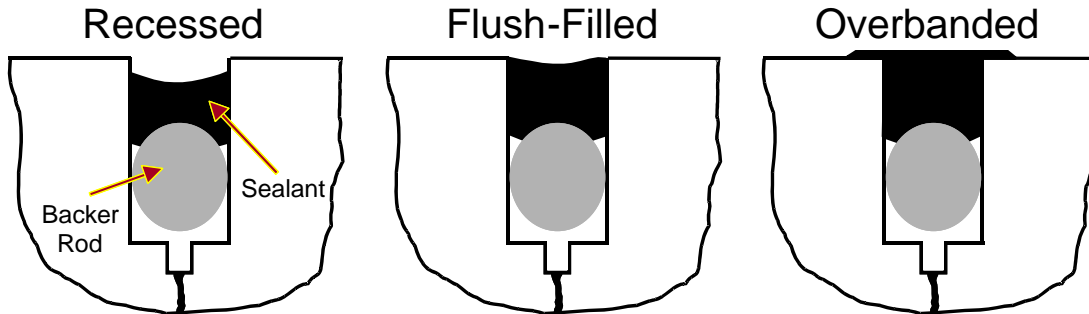

Figure 4-2 Joint sealant configurations (FHWA, 2004)

### Preformed Sealant Reservoirs

Although compression seals are not used for resealing, they may be used in new joints constructed as part of pavement restoration activities. Sizing of preformed compression seals is based on the approximate pavement temperature at installation and the expected range of joint movement. Reservoir design for preformed sealants starts with estimating horizontal joint movement using Equation 4-1. The next step is to select a compression seal that has allowable movement less than or equal to the calculated  $\Delta L$ . The appropriate sealant width is about twice the width of the reservoir. The reservoir must be deeper than the depth of the compressed seal, but shape factor is not a consideration for compression seals. Figure 4-3 shows a cross-section of a typical compression seal.

Reservoir saw cut width must correspond to both the seal size and movement range criteria using a rough estimate of installation temperature. The primary impact of installation temperature is to assure that the seal will operate in the desired 20-50% compression range. More seal compression is required when installation temperatures are warmer and joints are narrower; less compression is needed at lower temperatures when the joints are partially open. Saw cut width is calculated according to Equation 4-3 (FHWA Technical Paper 89-04, 1989).

$$S_c = (1 - P_c)(W) \quad (\text{Eq. 4-3})$$

Where:

- $S_c$  = Saw cut width of joint
- $W$  = Width of the uncompressed seal
- $C_{\min}$  = Minimum recommended compression of seal (usually 0.2)
- $C_{\max}$  = Maximum recommended compression of seal (usually 0.5)
- $P_c$  = Percent compression of seal at installation (decimal value)

$$P_c = C_{\min} + \left( \frac{\text{Install.Temp} - \text{Min.Temp}}{\text{Max.Temp} - \text{Min.Temp}} \right) (C_{\max} - C_{\min})$$

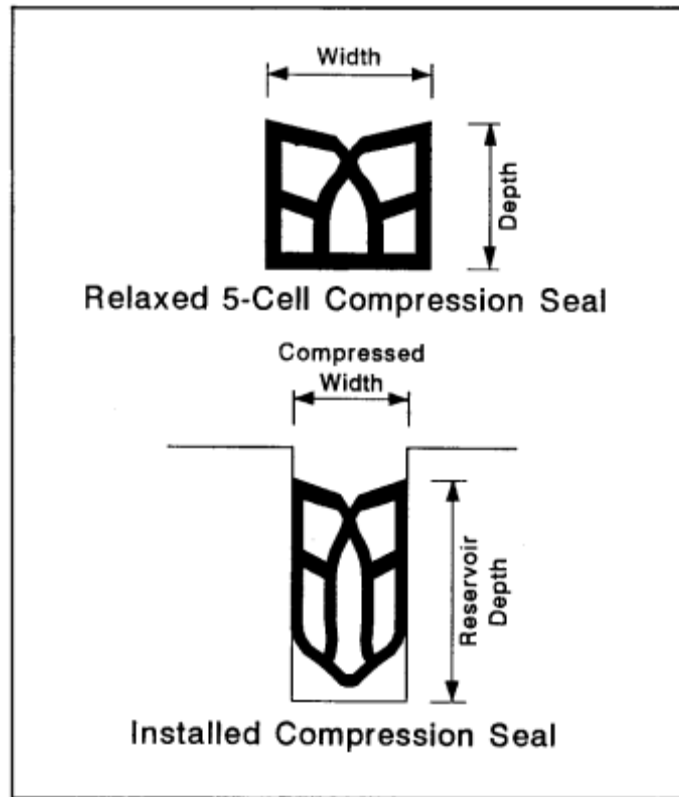

Figure 4-3 A typical five cell seal cross-section (ACPA, 1993)

#### 4.4.6 Special Considerations for Cracks

Concrete cracks due to a number of factors. The ACPA has identified seven primary causes:

- Plastic shrinkage
- Drying shrinkage
- Restrained thermal contraction
- Thermal and moisture differences
- Variations in support
- Reflection of underlying distress
- Load

Cracks require sealing for the same reasons as do joints and effective sealing limits deterioration of the JPCP slabs over time. Transverse cracks in CRCP should not be sealed. The type, severity, and extent of cracking govern the approach to treating the distress. For example, hairline cracks rarely require treatment, but full depth working cracks in PCC should be treated as joints and sealed accordingly. Random low- or medium-severity transverse and longitudinal cracks  $\leq \frac{1}{2}$ -inch (13 mm) wide are good candidates for sealing (ACPA, 1993).

In order to decide whether to seal or fill a crack, it is necessary to determine how wide it is, whether the crack is working or non-working, and whether it undergoes horizontal or vertical movement. Crack sealing is usually triggered when the crack width exceeds 1/4 inch (6 mm). The total horizontal movement of a crack over the period of one year is the primary indicator of whether a crack is working or not. The Caltrans criterion for a working crack is  $\geq \frac{1}{4}$  inch (6 mm) of horizontal movement on an

annual basis. Vertical movement is not usually calculated although it may affect sealant performance. Working cracks can be transverse or longitudinal to the pavement, but are most often transverse. Working cracks with limited spalling or edge deterioration should be routed and sealed rather than filled. Crack sealing requires thorough crack preparation and typically uses specialized or high quality materials; it should perform longer than simple crack filling.

When cracks are not working, or when cracks are closely spaced and have little movement, less costly crack filling may be an acceptable alternate to crack sealing. Filling is considered to be a relatively short-term treatment, but may serve well for low traffic volume pavements. Crack filling typically involves less crack preparation than sealing and performance requirements for filler materials may be more modest. Note that not all cracks need to be filled; only those 1/8” (3 mm) or more in width and which are full depth cracks need to be filled. Filling partial-depth cracks like those in CRCP can be detrimental and should not be attempted.

#### 4.4.7 Typical Item Codes

Typical item codes for a joint resealing and crack sealing project are given in Table 4-2.

Table 4-2 Typical item codes for a joint resealing and crack sealing project

Item Code	Description
120090	Construction area signs
120100	Traffic control system
128650	Potable changeable message sign
413111	Repair spalled joints
413114	Replace joint seal (existing concrete pavements)
413115	Seal joint (existing concrete pavements)
414091	Seal longitudinal joint
414101	Seal transverse joint
414111	Rout and seal random cracks

*Note: Standard special provisions and the PS&E Guide must be followed for the specific item codes proposed for the project.*

Caltrans Standard Materials and Supplemental Work Item Codes can be found at the following web site:

[http://i80.dot.ca.gov/hq/esc/oe/awards/#item\\_code](http://i80.dot.ca.gov/hq/esc/oe/awards/#item_code)

## 4.5 CONSTRUCTION PROCESS

Proper preparation of joints and cracks and installation has been proven to be critical to the long term performance of the selected sealant or filler. Attention to detail is important. The required steps for successful joint resealing and crack sealing with liquid sealants are listed below and are detailed in this section.

- Remove old sealant
- Shape reservoir / reface joint
- Clean the reservoir
- Install backer rod
- Install sealant

#### 4.5.1 Traffic Control and Safety

The traffic control plan for joint and crack resealing shall be prepared in accordance with the Caltrans Safety Manual and the Caltrans Code of Safe Operating Practices. The signs and devices used must match the traffic control plan. The work zone must conform to Caltrans practice and requirements set forth in the Caltrans Safety Manual and the Code of Safe Operating Practices along with any other pertinent requirements. Each worker must be fully equipped with the required safety equipment and clothing. Signage shall be removed when it no longer applies.

Depending on the project location, size and amount of work, one of the following types of traffic control alternatives may be considered:

- Complete roadbed closure
- Continuous lane closure
- Weekend closure
- Nighttime closure

#### 4.5.2 Equipment

**Equipment for preparing and cleaning joints and/or cracks includes:** rectangular joint plows, diamond saws, routers, high pressure air and/or water blaster(s), and sandblasters.

A “joint plow” is a blade that is mounted on the hydraulic mount of a tractor or the bucket of a skid loader that can move vertically and horizontally in the joint without binding. The plow blade is inserted into the joint and pulled along each joint edge to scrape the sealant off the joint faces. To avoid damaging the joint faces, the blade must be rectangular and fit freely into the joint. Caltrans does not allow V-shaped plows. Blades of several widths should be on hand, as joint widths are seldom uniform over an entire project.

Diamond-bladed saws are water-cooled devices equipped with diamond-edged blades. A single, full-width blade is useful for maintaining joint width; however, the edges wear quickly, thus reducing the effectiveness of sawing. Two blades separated by a spacer to achieve the desired width can be used on the same arbor, but the blades are thinner and may warp if overheated. Diamond saws may be used on fairly straight cracks. Routers are used to form a reservoir along cracks.

Power-driven wire brushes should not be used to remove old sealant or to clean PCC pavement joints. Air blasting equipment consists of high-pressure air compressors with hoses and spray wands. High-pressure air compressors are effective at removing dry dust and debris from a joint. Caltrans SSPs require a minimum compressed air delivery rate of 120 cubic feet per minute (3.4 m<sup>3</sup>/min), with a minimum nozzle pressure of 90 psi (0.6 MPa). The air shall be free of oil and moisture.

Sandblasting equipment is used to remove laitance, remaining debris, and remnants of old sealant. It includes a compressed air unit, a sandblasting machine, hoses, and a spray wand with a venturi-type nozzle. Caltrans SSPs do not distinguish between compressed air requirements for air blasting and sandblasting.

Air compressors must be equipped with working water and oil traps to prevent contamination of the joint faces. To ensure oil- or water-free operations, compressors are tested by air blasting into a clean white cloth, which is then checked for contamination.

**Equipment for sealer and/or filler installation includes:** melters for hot applied materials, and pumps and applicators for hot- and cold-applied materials, materials.

Melters are used to heat and mix hot-applied thermoplastic materials. Melters burn either propane or diesel fuel, and the resulting heat is applied to a transfer oil that surrounds a double-jacketed melting vat containing the sealant material. This apparatus provides a controlled and uniform heat (350-400°F [175-205°C]) for application. Temperature control is required to avoid overheating and degradation of the sealant. Agitators are required for asphalt-rubber sealants.

Compressed air-powered silicone pumps are used to pump one-component silicone materials from storage containers for application at ambient temperature. A feed rate of at least 0.4 gallons/minute (1.5 L/min) is recommended. The applicator wand is equipped with a nozzle that fits into the reservoir to allow filling from the bottom up.

Applicators for hot-applied sealers are generally pressure-wand systems. Sealant material is pumped directly from the melter tank through the hoses and applicator wand, and into the bottom of the joint.

#### 4.5.3 *Remove Old Sealant*

Removal of the old sealant material is critical to provide a surface to which the new sealant can bond, especially since the liquids used for resealing work by adhesion to the joint faces. It is important to avoid damaging the joint reservoir during the removal process. Sawing with diamond blades is an efficient method for combining sealant removal and joint refacing steps, and has thus become very popular. However, sawing works best for removing somewhat hardened sealants. Sticky, temperature susceptible materials may gum up the saw blades and/or joint faces. Rectangular joint plows may also be used, or a knife blade can be used to cut the sealer away from the PCC. Caltrans SSP 41-210 allows these three removal methods and also requires removal of backer rods. Contractors are required to submit the proposed removal method for Caltrans review and approval prior to removal.

#### 4.5.4 *Shape Reservoir / Reface Joint*

If the old sealant was removed by means other than a diamond bladed saw, it may be necessary to perform a separate joint refacing operation using wet or dry sawing with diamond blades. Caltrans allows either single pass or double pass saw cuts for this purpose at the Contractor's option.

Care should be exercised when refacing. Excessive widening of joint reservoirs may change the shape factor and affect performance of the sealant. Wide joints may also increase the likelihood of "wheel slap" which generates unwanted tire noise.

#### 4.5.5 *Clean Joint Reservoir*

Cleaning the reservoir is the most important part of joint sealing. Performance of liquid sealants depends on good adhesion of the sealant to the joint faces. Any dust, dirt or old sealant remaining on the joint faces blocks the new sealant from direct contact and bonding with the JPCP. Aside from old sealant, materials that may contaminate the joints include:

- Water-borne debris (laitance) from wet sawing.
- Oil or water blown in by the compressed air stream.
- Dust and dirt left behind by the cleaning operation.
- Material that enters the joint between cleaning and sealing.
- Other contaminants that may inhibit bonding, including moisture condensation.

After joint refacing is completed, the joint should immediately be cleaned with high-pressure air or water, and dried. Caltrans does not allow chemical solvents to be used to wash joints. Cleaning

narrow joints (less than ¼-inch [6 mm] wide) is more difficult than cleaning joints that are at least 3/8-inch (10 mm) wide. Sandblasting follows to remove laitance (wet-sawing residue) and any other residue on the joint faces. The resulting surface texture enhances sealant adhesion. A minimum of one pass is required to clean each joint face, and close attention must be paid to the work to ensure consistent, thorough cleaning. Best practice is to angle the air rather than blasting directly into the reservoir. During the sandblasting operation, the operator should use appropriate safety equipment including a proper helmet and a breathing apparatus. Following sandblasting, the entire length of each joint face should be visibly clean with the concrete exposed.

Final air blasting should be performed no more than one hour before backer rod and sealant installation. Joints and surrounding surfaces should be air blasted in one direction, away from prevailing winds and taking care not to contaminate previously cleaned joints. Care must also be taken not to blow debris into traffic in the adjacent lanes. Caltrans requires vacuum removal of the air blasting debris and residue. When compression seals are to be used for sealing restored joints, sandblasting and final air blasting are not required.

#### 4.5.6 *Install Backer Rod*

Backer rod should be installed as soon as possible after the joints are properly prepared and cleaned. Caltrans requires a minimum air temperature of 40°F (5°C) and JPCP temperature above the dew point for backer rod installation. The backer rod must be a flexible, non-absorptive material that is compatible with the sealant material being installed. Because reservoir widths vary, several different sizes of backer rods should be available. The diameter of the backer rod should be about 25 percent larger than the joint width; if this does not provide a tight seal, a larger diameter rod should be substituted.

It is critical to install the backer rod to the proper depth, with no gaps between backer rod strips. The rod should be stretched as little as possible to reduce the likelihood of shrinkage and development of gaps. Backer rod may be installed using a special steel roller (single or double-wheeled) or other smooth blunt tool that does not puncture or stretch the backer material.

#### 4.5.7 *Install Sealant*

Immediately before any liquid sealant is installed, the cleanliness and dryness of the joint reservoirs must be verified. Installation requirements may differ for each sealant product, so it is important to understand and follow the manufacturer's recommendations to avoid unnecessary problems. Recommendations may include limits on pavement and ambient installation temperatures, moisture conditions, and/or on curing time before opening the roadway to traffic.

#### **Hot -Applied Sealants**

Hot-applied sealant materials should generally be placed when the air temperature is at least 40°F (5°C) and rising (FHWA, 2002), but Caltrans requires a minimum installation temperature of 50°F (10°C) for asphalt-rubber sealants. It is important to follow the manufacturers' recommendations for heating and handling, including maximum sealant temperature, placement temperature, and any limitations on heating time. Many of the polymer- and rubber-modified sealants may break down when heated above the recommended safe heating temperature. Prolonged heating can cause some sealant materials to gel in the heating tank while others experience significant changes (usually losses) in their elastic properties.

The sealant material should be uniformly installed by filling the joint reservoir from the bottom up and pulling the nozzle toward the installer to avoid trapping any air bubbles, but not overfilling it.



Caltrans Standard Plan P 20 shows that the surface of the sealant is to be recessed  $3/8'' \pm 1/16''$  (10 mm  $\pm$  1.5 mm) below the surface of the pavement to allow room for expansion during hot weather without extruding the sealant from the joint. Some manufacturers recommend that the joint be flush filled with sealant. To avoid “tracking” of the sealant, traffic should not be allowed on the newly sealed joints for about 30 minutes to 1 hour after sealant placement. Consult the manufacturer’s instructions for information regarding opening to traffic, consider effects of site weather conditions, and evaluate the in-place curing before allowing traffic on the newly sealed joints.

### **Cold-Applied Sealants**

Minimum installation temperature for silicone sealants is generally 40°F (5°C). Silicone sealants should be installed in the same manner as hot-applied sealants, from the bottom to the top of the joint and pulling the nozzle toward the installer. Minimum placement thickness is  $1/4$ -inch (6 mm), and shape factor can vary from 0.5 to 2.0. Typical curing time is about one hour, but please check the manufacturer’s instructions for specific recommendations about opening to traffic.

Nonself-leveling silicone sealants must be tooled to force the sealant around the backer rod and against the joint sidewalls, and to form a concave sealant surface. Large diameter backer rod and rubber hose have been used for tooling, which should be performed before the sealant starts curing, generally within about 10 minutes after installation.

Self-leveling silicone sealants do not require tooling, but may flow easily around loose backer rod or out at unblocked joint ends prior to curing, so particular care is required during installation of backer rod and sealant. Some agencies have mandated tooling in order to enhance the bond between the pavement and the sealant even if the material does not require it.

**NOTE:** When installing both silicone and asphalt-rubber sealants on a single pavement section, for example, where silicone sealant is to be used in the transverse joints and asphalt-rubber in the longitudinal joints, the silicone should be installed first to reduce the potential for contamination of the transverse joint during the longitudinal joint sealing operations (FHWA, 1985). This is not an uncommon occurrence; cold-applied sealants should be installed first, regardless of the orientation of the joint.

### **Longitudinal Joint Resealing**

As previously discussed, there are two types of longitudinal joints in PCC that may be resealed: joints between adjacent PCC slabs and joints between the mainline PCC pavement and an AC shoulder. Although the procedures are basically the same as for transverse joint resealing, there are some additional considerations.

**Rigid to Rigid Joints:** Longitudinal joints between adjacent JPCP slabs are generally tied together with tiebars, which limits slab movement so that conventional joint sealing operations can be conducted. These joints are generally sealed with a hot-applied material, and typically no reservoir is needed or formed. If transverse joints are to be sealed with silicone, seal them first to prevent contamination by hot-applied sealant material.

**Rigid to Flexible Shoulder:** Because of the differences in material properties, joints between a JPCP mainline pavement and a flexible pavement shoulder often experience large differential vertical movements that may be accompanied by considerable horizontal movement and separation along the longitudinal joint. Sealing is required to minimize water infiltration. The primary difference from typical transverse joint sealing operations is that an extra wide reservoir (minimum one-inch, shape factor of 1.0) is cut in the existing HMA shoulder to allow for the anticipated movements. If the

reservoir is of uniform depth, a backer rod is generally not needed. Many agencies routinely use hot-applied materials to seal this joint, although some silicone materials have been developed for this application.

### **Compression Sealing**

Compression seals can be installed in both new and restored transverse joints. Face preparation is limited to identifying areas of raveling, spalling, or other defects that might interfere with sealant compression and allow pop-outs or extrusions, and making suitable repairs prior to installing the seals. Installation of compression seals requires application of a lubricant/adhesive to the seal and the joint faces. The seal is mechanically compressed and inserted into the reservoir. Most of the compression seal manufacturers make installation devices. The most common type is a “compress-eject” machine. These machines have some propulsion and insertion depth control, and they are equipped with a guide to keep them on the joint. They eliminate a number of problems that may be caused by hand installation, such as twisting and stretching. Splicing of compression seals is to be avoided if feasible, as this can create discontinuities; for joints less than 25 feet (7.5 m) in length, only one piece of compression seal should be used. If used for longitudinal joints, the compression seal should be cut at the transverse joint crossings.

#### *4.5.8 Crack Sealing*

Crack sealing in JPCP follows the same basic steps as joint sealing: refacing, cleaning, backer rod installation, and sealant installation (ACPA, 1993). The first step is to reface the crack to the desired width. However, the orientation of most PCC pavement cracks makes it difficult to create a uniform sealant reservoir directly along the crack. Small diameter, diamond-bladed saws have been used successfully (ACPA, 1993) to form reservoirs. The cutting blades for these saws are typically about 7 to 8 inches (180 to 200 mm) in diameter and ¼- to ½-inch (6 to 12 mm) wide. The width of the saw cut usually yields an appropriate shape factor for the expected crack movement. Smaller blade diameters and some lightweight two- or three-wheel unit designs allow crack saws to pivot and follow irregular crack profiles. Although the saws are not generally as maneuverable as routers, they don't have as much potential for spalling the crack faces either.

After the reservoir is created, the crack should be cleaned as if it were a joint to be resealed. Sandblasting is highly recommended. Then the crack is blown with compressed air and the backer rod (if specified) and sealant material are installed. The same precautions that apply to the installation of sealant materials into joints also apply to crack sealing (ACPA, 1993). Use of epoxy or glue working cracks is not generally recommended, as it often contributes to subsequent adjacent thermal cracking.

After installation, the sealant should be visually examined to assure application is complete, with no gaps or obvious defects. Adhesion to the joint faces should be spot-checked with a simple knife test.

#### *4.5.9 Trafficking*

Curing requirements for sealants and fillers are material-dependent, but may also be affected by on-site weather conditions. Hot applied materials are thermoplastic; they set when they cool and produce a non-tacky finish. A light application of sand may be applied to the surface of the sealant to prevent pick up or pull out by tires. Hot applied sealants typically should be allowed a three to four month curing time prior before being covered with a maintenance overlay or seal coat.

Silicones used by Caltrans are one-part formulations that cure primarily by cross-linking due to ambient moisture. The manufacturer's recommendations regarding opening to traffic must be followed. Sanding the fresh sealant reduces safety concerns (slick pavements) and improves the

surface appearance (aesthetics). Excess sand must be swept away before opening the roadway to traffic. Cold applied sealants require a one year cure time prior to being covered with an overlay or seal.

#### 4.5.10 Quality

Performance of joint and crack sealants appears to depend at least as much on the preparation and application processes as on the quality of the materials used. The care and workmanship exercised by contractor personnel are critical to the success of joint resealing and crack sealing projects. This section summarizes key aspects of quality control and assurance. Detailed project checklists and troubleshooting guide for every aspect of materials, equipment, and execution are included in Sections 4.7.1 and 4.7.2, towards the end of this chapter.

#### **Project Review**

Prior to the start of work, the condition of the subject pavement should be reviewed to verify that no significant changes have occurred since the project was designed, and that the joint and crack treatments are still appropriate as designed. Methods designated for sealant removal, refacing, and cleaning should be reviewed. For joint resealing projects, joint reservoir design(s) and sealant type should be checked with respect to the expected project climate and traffic conditions. Consideration should also be given to project scheduling to evaluate possible effects of expected weather conditions at the time of installation.

The following project documents and submittals should also be reviewed to identify any potential issues:

- Project specifications and design (as bid and awarded).
- Project special provisions.
- Traffic control plan submitted by the contractor.
- Manufacturer's instructions for sealant handling and installation.
- Material safety data sheets (MSDS).

#### **Materials Review**

Materials review consists primarily of ensuring that the proposed sealant materials meet project specifications and that sufficient quantities are available which have not been damaged during shipping and storage, and that they remain within their respective shelf lives. This is covered under Caltrans Standard Plan P20, which requires specific diameters of backer rod; however additional sizes are often required to properly prepare individual joints that are wider than typical, therefore some larger sizes should be readily available at the job site.

#### **Equipment Inspection**

The equipment used to prepare the joints and cracks and to install the sealant must be examined prior to the start of construction. Some of the most important items to check are listed below. Extensive, detailed lists of specific items are included in the FHWA checklist (FHWA, 2002).

Melters for hot-applied sealants should be inspected to verify that they are functioning properly. Items to inspect include: the hot-oil heating system including thermostats and controls, agitation in the melter vat, valve operation, the hot sealant pumping system including hoses, and size of wand tips.

Equipment for cold-applied sealants is less complicated. The primary items to check include pump function, condition of the follower plates, condition of the hoses, and size of applicator tips

Joint cleaning and refacing equipment includes air, water, and sand blasters. These devices use air compressors that must meet minimum requirements for volume and pressure, and they require filters or traps for water and oil. Function of the compressors and traps should be verified. For sandblasters, type of abrasives used must be environmentally acceptable and their feed rates properly controlled. Caltrans SSPs do not require use of water blasters but, if used, these must provide the required volume of water and pressure. Size and function of concrete saws and diamond tipped blades should be verified. If used, size and shape of joint plows must also be verified.

### **Installation**

**Joint Preparation:** Activities involved in joint preparation include removal of old sealant, shaping the reservoir / refacing the joint walls, and cleaning and drying the joint reservoir. The contractor and assistant resident engineer (RE) should verify that these operations are performed correctly with the proper equipment and level of workmanship. Propane torches should no longer be used to dry joint reservoirs to avoid damaging the PCC or adjacent asphalt concrete shoulders. Each joint should be inspected prior to sealing to verify that the joint faces are clean enough for installation of liquid sealants, and identify any locations that need further cleaning.

**Install Backer Rod:** The primary items to check include installation at the designated depth below the pavement surface and uniformity thereof, and how well the backer rod fits in the joint (is a larger diameter needed?). The backer rod should be inspected to verify that is not being stretched or damaged in the process.

**Hot-Applied Sealant Installation:** Temperature control is crucial to avoid damaging sealant materials by overheating and to promote uniform application and bonding with joint faces. Inspectors are encouraged to use their own temperature measuring devices to monitor sealant temperature and supplement those of the Contractor. Use the Caltrans SSPs, manufacturer's instructions, and the FHWA checklist to verify that the sealant materials are handled and applied correctly. The sealant in the melter should be continuously agitated. Joints should be sealed from the bottom up to the designated depth below the pavement surface by pulling the nozzle towards the operator to avoid trapping air bubbles. One item of particular importance is the hose from the melter to the applicator wand. If the hose is not heated, the sealant should be recirculated to prevent slugs of cooler material from plugging the line. The Inspector should spot test adhesion at several random locations after the sealant has cooled by inserting a knife or thin strip of metal between the sealant and the joint faces. The roadway should not be opened to traffic until the sealant has cooled; however some sealants may remain tacky for some time after application. Therefore, before opening to traffic, the Inspector should determine whether a blotter application is needed to prevent pick up by vehicle tires.

**Cold-Applied Sealant Installation:** These materials are installed at ambient temperature in the same manner as hot-applied sealants—from the bottom up to the designated depth below the pavement surface by pulling the nozzle towards the operator to avoid trapping air bubbles. Caltrans SSPs require tooling silicone sealants within 10 minutes of application, and they make no distinction regarding whether they are non-sag (requires tooling) or self-leveling materials. Adhesion should be checked and the sealant cured until it is tack-free before opening the roadway to traffic.

## 4.6 SUMMARY

This chapter describes joint sealing/resealing and crack sealing treatments for JPCP pavements. Sealant materials (hot- and cold-applied and preformed) and their properties are discussed, and pertinent specifications listed. Design considerations are presented, including project selection criteria, materials selection, anticipated joint movement, reservoir design/shape factor, sealant configuration, special considerations, and sealing versus filling.

Processes for sealing/resealing of transverse and longitudinal joints and cracks are discussed, including: removing the old material (resealing only), refacing the existing joint/crack reservoir, cleaning, installing backer rod, and installing the new sealant material. Recommendations for quality assurance, quality control, and troubleshooting are also presented.

## 4.7 PROJECT CHECKLIST AND TROUBLESHOOTING GUIDE

The project checklist and the troubleshooting guide, included in this section, provide important information which can help solve difficulties as they occur. The checklist also helps improve performance in joint resealing and crack sealing. The project checklist describes important aspects of the entire process, such as preliminary responsibilities, material and equipment requirements, project inspection responsibilities, and cleanup responsibilities, all of which should be considered in order to promote a successful job. The troubleshooting guide also describes common problems encountered during construction and their solutions.

### 4.7.1 Project Checklist

The following checklists were primarily based on guidelines from the FHWA Pavement Preservation Checklist Series ([http://www.fhwa.dot.gov/pavement/pub\\_details.cfm?id=351](http://www.fhwa.dot.gov/pavement/pub_details.cfm?id=351)) and the FHWA Course: Pavement Preservation Design and Construction of Quality Preventive Maintenance Treatments.

<b>Preliminary Responsibilities</b>	
<b>Project Review</b>	<ul style="list-style-type: none"> <li>✓ Review joint condition to verify that the specified joint size is appropriate.</li> <li>✓ Verify that pavement conditions have not significantly changed since the project was designed and that joint sealing is appropriate for the pavement.</li> <li>✓ Joint design and sealant type are appropriate for the project climate and conditions.</li> <li>✓ Joint cutting and cleaning methods are appropriate.</li> <li>✓ Methods to remove old sealant materials are appropriate.</li> </ul>
<b>Document Review</b>	<ul style="list-style-type: none"> <li>✓ Bid/Project specifications and design</li> <li>✓ Special provisions</li> <li>✓ Traffic control plan</li> <li>✓ Manufacturer’s sealant installation instructions</li> <li>✓ Agency application requirements</li> <li>✓ Sealant material safety data sheet</li> </ul>
<b>Materials Checks</b>	
<b>Sealant</b>	<ul style="list-style-type: none"> <li>✓ Correct sealant to meet specification requirements.</li> <li>✓ Certificate of compliance.</li> <li>✓ Sealant has been sampled and tested prior to installation (if required).</li> <li>✓ Sealant packaging is not damaged in a way that will prevent proper use (boxes leaking, pail or drums dented or pierced).</li> </ul>

	<ul style="list-style-type: none"> <li>✓ Chemically curing sealants are within shelf life.</li> </ul>
<b>Primer</b>	<ul style="list-style-type: none"> <li>✓ Primer, if used, meets specification requirements.</li> </ul>
<b>Backer rod</b>	<ul style="list-style-type: none"> <li>✓ Backer rod is of the proper size and type for hot- or cold-applied sealants.</li> </ul>
<b>General</b>	<ul style="list-style-type: none"> <li>✓ Sufficient quantities of all materials are available for completion of the project.</li> </ul>
<b>Equipment Inspections</b>	
<b>Hot-Applied Sealant Melters</b>	<ul style="list-style-type: none"> <li>✓ For hot-applied sealants, an indirectly heated double boiler type melter with effective agitation is being used.</li> <li>✓ Melters are in good working order with all heating, agitation, pumping systems, valves, thermostats, etc., functioning.</li> <li>✓ Melter heating system is thermostatically controlled.</li> <li>✓ Temperature gauges have been calibrated and checked for accuracy.</li> <li>✓ Proper size wand tips for desired application are available.</li> <li>✓ Melter is of sufficient size for the project.</li> </ul>
<b>Cold-Applied Sealant Pumps</b>	<ul style="list-style-type: none"> <li>✓ The pump is in proper working order.</li> <li>✓ The follower plate(s) are in good shape and lubricated.</li> <li>✓ Verify that two-component pump is delivering material at the correct ratio (per manufacturer's recommendations).</li> <li>✓ Hoses are not plugged.</li> <li>✓ For two-component pumps, an appropriate mixing head meeting manufacturer's requirements is available.</li> </ul>
<b>Joint Cleaning Equipment</b>	<ul style="list-style-type: none"> <li>✓ Abrasive cleaning unit is adjusted for correct abrasive feed rate and has oil and moisture trap.</li> <li>✓ Abrasive cleaning uses environmentally acceptable abrasive media.</li> <li>✓ Abrasive cleaning operators use appropriate air purification systems as required.</li> <li>✓ Air compressors have sufficient pressure and volume to clean joints adequately and meet agency requirements.</li> <li>✓ Air compressors are equipped with oil and moisture filters/traps that are properly functioning. Check the airstream for water or oil prior to use by passing the stream over a board and examining for contaminants.</li> <li>✓ Joint plows (if used) are of correct size and configuration to remove required amount of old sealant without spalling joint edges.</li> <li>✓ Concrete saws/blades are of sufficient size to adequately cut the required joint width and depth, and the saw is in good working order.</li> <li>✓ Waterblasting equipment can supply the water volume and pressure required by specifications.</li> <li>✓ Wire brush cleaners have brushes in good condition and are functioning properly.</li> </ul>
<b>Other Equipment</b>	<ul style="list-style-type: none"> <li>✓ Backer rod insertion tool is adjusted for correct installation depth and does not have sharp or jagged edges that could cut or abrade backer material.</li> <li>✓ Brushes or sprayers for primer application (if used) are available.</li> <li>✓ Tooling/Leveling devices for finishing the sealant to the required dimensions are available.</li> <li>✓ Preformed sealant insertion devices function properly and insert seal strips without excessive stretching and to the correct recess.</li> </ul>

<b>Others</b>	
<b>Weather Requirements</b>	<ul style="list-style-type: none"> <li>✓ Review manufacturer installation instructions for requirements specific to sealant used.</li> <li>✓ Air and/or surface temperature shall meet manufacturer and all agency requirements (typically 40 °F (4 °C ) and rising) for sawing and sealing.</li> <li>✓ Sealing shall not proceed if rain is imminent.</li> <li>✓ Application does not begin if there is any sign of moisture on the surface or in the joint.</li> </ul>
<b>Traffic Control</b>	<ul style="list-style-type: none"> <li>✓ The signs and devices used match the traffic control plan.</li> <li>✓ The setup complies with the Federal Manual on Uniform Traffic Control Devices (MUTCD) or local agency requirements.</li> <li>✓ Flaggers do not hold traffic too long.</li> <li>✓ Any unsafe conditions are reported to a supervisor.</li> <li>✓ The sealed pavement is not opened to traffic until the sealant has adequately cooled or cured to not pick up on vehicle tires.</li> <li>✓ Signs are removed or covered when they are no longer needed.</li> </ul>

<b>Project Inspection Responsibilities</b>	
<b>Joint Preparation</b>	<ul style="list-style-type: none"> <li>✓ During cutting and cleaning operations, all safety mechanisms and guards on equipment are in place and functioning properly, and operators are using required personal protective equipment.</li> <li>✓ Old sealant (if present) is removed from the joint.</li> <li>✓ Concrete is allowed to cure for the specified time prior to sawing joints.</li> <li>✓ Joint is sawn or refaced to produce a rectangular reservoir of the specified depth with cut vertical sides.</li> <li>✓ After sawing, joints are flushed with high pressure water to remove all saw slurry and debris.</li> <li>✓ Joint surfaces are cleaned using abrasive cleaning, waterblasting, or wire brushing.</li> <li>✓ Abrasive cleaning is accomplished with the nozzle 1 to 2 in (25 to 50 mm) above the joint using two passes, each directed at one of the joint faces.</li> <li>✓ Joint is blown clean with clean dry air.</li> <li>✓ Primer, if used, is applied at the correct coverage rate and allowed to cure as required by the manufacturer.</li> <li>✓ Inspect joints prior to sealing by rubbing your finger along the joint walls to insure that no contaminants (dust, dried saw residue, dirt, moisture, or oil) are on the joint walls. If dust or other contaminants are present, reclean joints to a satisfactory condition.</li> <li>✓ Inspect joints for proper sealant geometry.</li> </ul>
<b>Backer Material Installation</b>	<ul style="list-style-type: none"> <li>✓ Backer material (rod) is installed after final joint cleaning and inspection for cleanliness, and just prior to sealant installation.</li> <li>✓ Backer is inserted uniformly without stretching into the joint to the required depth to provide the specified sealant dimensions.</li> <li>✓ Backer fits snugly in the joint with no gaps along the joint sides.</li> <li>✓ Backer is not torn, abraded, ripped, or otherwise damaged during installation.</li> </ul>
<b>Sealant Installation Hot-Applied Sealants</b>	<ul style="list-style-type: none"> <li>✓ Manufacturer's installation instructions are being followed.</li> <li>✓ Melter heat transfer medium is heated to the correct temperature range.</li> <li>✓ Sealant is heated to a minimum of the manufacturer's recommended pouring or application temperature, but the temperature shall not exceed the material's safe heating temperature.</li> </ul>



	<ul style="list-style-type: none"> <li>✓ Sealant is continuously agitated to assure uniformity, except when adding additional material.</li> <li>✓ Operator wears required personal protective equipment.</li> <li>✓ If melter is equipped with a heated hose system, the hose is heated to operating temperature prior to beginning sealant application.</li> <li>✓ If melter does not have a heated hose, verify that the hose is unplugged and clear prior to beginning application.</li> <li>✓ If melter does not have a heated hose, sealant shall be recirculated through the hose to warm the hose prior to application. During idle periods, or if it is noted that sealant is cooling through the hose, sealant shall be recirculated through the hose back into the material vat to maintain hose temperature.</li> <li>✓ Sealant temperature is checked periodically to assure proper temperatures.</li> <li>✓ Melting vat should be kept at least one-third full to help maintain temperature uniformity.</li> <li>✓ Joint is filled from the bottom up to the specified level to produce a uniform surface with no voids in the sealant.</li> <li>✓ Detackifier or other blotter is applied to reduce tack prior to opening to traffic, if needed.</li> <li>✓ Traffic is not allowed on project until sealant is tack-free or cooled.</li> <li>✓ Verify adequate adhesion by pulling up several random sections of cooled sealant.</li> </ul>
<b>Sealant Installation Cold Applied Sealants</b>	<ul style="list-style-type: none"> <li>✓ Joint is filled from the bottom up to the specified level to produce a uniform surface with no voids in the sealant.</li> <li>✓ Verify correct ratio, mixing, and curing of two-component sealants using a test strip prior to beginning full-scale project sealing.</li> <li>✓ Tool nonsag sealants to force the material against the sidewalls and to form a smooth surface at the specified recess from the surface.</li> <li>✓ Sealant is permitted to cure to a tack-free condition prior to opening the pavement to traffic.</li> <li>✓ Verify adequate adhesion by pulling up several random sections of cured sealant.</li> </ul>
<b>Sealant Installation Preformed Sealants</b>	<ul style="list-style-type: none"> <li>✓ Manufacturer's installation instructions are being followed.</li> <li>✓ Lubricant/Adhesive is installed as specified.</li> <li>✓ Sealant size used is appropriate for the size of the finished joints.</li> <li>✓ Sealant is installed in a manner that does not stretch the seal beyond specified requirements.</li> <li>✓ Seal is installed to the required recess below surface level.</li> </ul>
<b>Opening the Pavement to Traffic</b>	<ul style="list-style-type: none"> <li>✓ The sealed pavement is not opened to traffic until the sealant has adequately cooled or cured to not pick up on vehicle tires.</li> <li>✓ All construction-related signs are removed when opening pavement to normal traffic.</li> </ul>
<b>Cleanup Responsibilities</b>	
<b>General</b>	<ul style="list-style-type: none"> <li>✓ Any excess sealant application or spills are removed.</li> <li>✓ All loose debris from cleaning is removed from the pavement surface.</li> <li>✓ Sealant containers or other miscellaneous debris are removed and disposed of properly.</li> <li>✓ Melters and other application equipment are properly cleaned for the next use.</li> </ul>

#### 4.7.2 Troubleshooting Guide

A number of factors can contribute to problems with joint resealing and crack sealing, although inadequate joint preparation has been shown to be one of the most common causes. FHWA has developed a troubleshooting guide that includes causes and remedies for some of the most common field problems, which is presented herein with a few additions (FHWA, 2004).

Problem	Causes and Solutions
Dust, dirt, or contamination on refaced joint or crack surfaces.	Causes: <ul style="list-style-type: none"> <li>• Improper cleaning techniques.</li> </ul> Solution: <ul style="list-style-type: none"> <li>• The presence of dust, dirt, or contaminants on the joint or crack walls typically results in poor sealant adhesion. If observed, the contractor should re-clean the surfaces in question using recommended techniques.</li> </ul>
Bubbles in hot-applied sealant material.	Causes: <ul style="list-style-type: none"> <li>• If reservoir walls are not free from moisture, moisture will boil in contact with hot-pour materials, forming steam that will bubble the sealant. Pushing the applicator wand away from the installer may also cause bubbles.</li> </ul> Solutions: <ul style="list-style-type: none"> <li>• Stop sealant installation procedures and allow reservoir walls to dry or accelerate the drying by blowing air into the reservoir.</li> <li>• Pull applicator wand towards the sealant installer.</li> </ul>
Punctured or stretched backer rod.	Cause: <ul style="list-style-type: none"> <li>• Improper backer rod installation techniques.</li> </ul> Solution: <ul style="list-style-type: none"> <li>• A punctured or stretched backer rod can result in an improper shape factor, adherence of sealant to bottom of reservoir, or loss of sealant through the hole. These conditions have detrimental effects on the long-term performance of the sealant. If observed, remove the existing backer rod and install a new backer rod using the recommended procedures.</li> </ul>
Raveling, spalling, or other irregularities of the joint walls prior to sealant application.	Cause: <ul style="list-style-type: none"> <li>• Improper care in sealant removal or in joint cleaning and refacing steps. Note: A V-shaped joint plow blade can spall joint sidewalls, which is why Caltrans does not allow their use.</li> </ul> Solution: <ul style="list-style-type: none"> <li>• Irregularities on joint walls can reduce the sealant's lateral pressure, therefore, allowing the sealant to extrude or pop from the joint (ACPA, 1993). If irregularities are observed, the agency and contractor should agree on an appropriate method for repairing potential problem areas.</li> </ul>
Difficulty in installing sealant material.	Causes: <ul style="list-style-type: none"> <li>• Burrs along the sawed joints.</li> <li>• Narrow joints leave little working room</li> </ul> Solution: <ul style="list-style-type: none"> <li>• Drag a blunt pointed tool along the sawed joint, or use a mechanized wire brush, to remove sharp edges (ACPA, 1993). Note: the joint or crack will have to be recleaned prior to sealing.</li> </ul>

<p>Tracking of material (i.e., the transfer of sealant material onto unwanted areas of the surface area via shoes, tires, and so on).</p>	<p>Cause:</p> <ul style="list-style-type: none"> <li>• Too much sealant is being applied.</li> <li>• Traffic is being allowed on the sealant before the material has a chance to sufficiently cool or cure.</li> <li>• The chosen sealant material is inappropriate for the climate in which it is being used.</li> </ul> <p>Solution:</p> <ul style="list-style-type: none"> <li>• Reduce the amount of sealant or filler being applied.</li> <li>• Allow more time for material to sufficiently cool or cure (or use sufficient sand for blotter coat).</li> <li>• Ensure the sealer/filler is appropriate for the climate in which it is being placed.</li> </ul>
<p>Bumps or irregularities in surface of tooled sealant application.</p>	<p>Cause:</p> <ul style="list-style-type: none"> <li>• Problem with quality of tooling equipment or quality of tooling process.</li> </ul> <p>Solution:</p> <ul style="list-style-type: none"> <li>• Check tooling utensil or squeegee and ensure it is leaving the correct finish. Repair or replace as necessary.</li> <li>• Ensure that tooling is being conducted within the time after application recommended by the manufacturer.</li> <li>• Decrease the viscosity of the sealant (if applicable).</li> </ul>

#### 4.8 KEY REFERENCES

- ACPA, 1993, *Joint and Crack Sealing and Repair for Concrete Pavements*, American Concrete Pavement Association, Skokie, IL, 1993.
- Caltrans, 1998, *Maintenance Manual Chapter B, Rigid Pavement*, Sacramento, California, June 1998.
- Caltrans, 2003, *Maintenance Technical Advisory Guide*, Sacramento, CA, October 2003.
- Caltrans, 2004, *Pavement Tech Notes – Concrete Pavement Design Overview*, Sacramento, California, October 2004.
- Caltrans, 2004, *Pavement Tech Notes –Interim PCC Pavement Rehabilitation Guidelines*, Sacramento, California, July 2004.
- Caltrans, 2006, *Replace Joint Seal (Existing Concrete Pavement)*, Standard Special Provisions, SSP 41-210, Sacramento, California, May 2006.
- Caltrans, 2006, *Seal Existing Concrete Pavement Joint*, Standard Special Provisions, SSP 41-200, Sacramento, California, May 2006.
- Caltrans, 2006, *Standard Plan P1, Jointed Plain Concrete Pavement*, Sacramento, California, May 2006.
- Caltrans, 2006, *Standard Plan P18, Concrete Pavement-Lane Schematics and isolation Joint Detail*, Sacramento, California, May 2006.
- Caltrans, 2006, *Standard Plan P20, Concrete Pavement Joint Details*, Sacramento, California, May 2006.

- Darter, M. I. 1977. *Design of Zero-Maintenance Plain Jointed Concrete Pavement, Volume I—Development of Design Procedures*, FHWA-RD-77-111. Federal Highway Administration, Washington, DC, 1977.
- Evans, L. D., K. L. Smith, and A. R. Romine. 1999. *Materials and Procedures for the Repair of Joint Seals in Portland Cement Concrete Pavements—Manual of Practice*, FHWA-RD-99-146. Federal Highway Administration, McLean, VA, 1999.
- FHWA, 1985. *Pavement Rehabilitation Manual*, FHWA-ED-88-025. Federal Highway Administration, Washington, DC, 1985.
- FHWA, 2002, *Pavement Preservation Checklist Series #6, Joint Sealing Portland Cement Concrete Pavements*, Publication No. FHWA-IF-03-003, FHWA, Washington DC, October 2002
- FHWA, 2004, *Pavement Preservation Design And Construction of Quality Preventive Maintenance Treatments*, NHI Course No. 131103, Federal Highway Administration, November 2004.
- Morian, D. A., N. Suthahar, and S. Stoffels. 1999. *Evaluation of Rigid Pavement Joint Seal Movement, TRR 1083*. Transportation Research Board, Washington, DC, 1999.

*Disclaimer*

*The contents of this guide reflect the views of the authors who are responsible for the facts and accuracy of the data presented herein. The contents do not necessarily reflect the official views or policies of the State of California or the Federal Highway Administration. This guide does not constitute a standard, specification, or regulation.*

## CHAPTER 5 DIAMOND GRINDING AND GROOVING

This chapter describes a treatment technique for restoring desired surface characteristics through diamond grinding and grooving. This chapter includes a discussion of design and specifications, project selection, and construction process. A project checklist and troubleshooting guide are also included in this chapter.

### 5.1 DESCRIPTION OF TREATMENT

#### 5.1.1 Overview

Diamond grinding is one of the most cost effective concrete pavement restoration (CPR) techniques. It consists of “grinding” 3/16 to 1/4 inch (5 to 7 mm) of the surface of jointed plain concrete pavement (JPCP) using closely spaced diamond saw blades. The result is a level, smooth, and generally quieter riding surface. The closely spaced grooves left after grinding give the riding surface excellent texture and frictional properties.

The same technique and equipment is used for diamond grooving. However, while the purpose of grinding is mainly to restore ride quality and texture, grooving is generally used to reduce hydroplaning and accidents by providing escape channels for surface water. In terms of design, the main difference between grinding and grooving is in the distance between the grooves – about 6 times higher in the case of grooving. Figure 5-1 is a photograph of the pavement surface after grinding while Figure 5-2 shows the pavement surface after grooving.

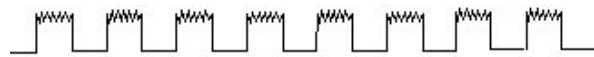
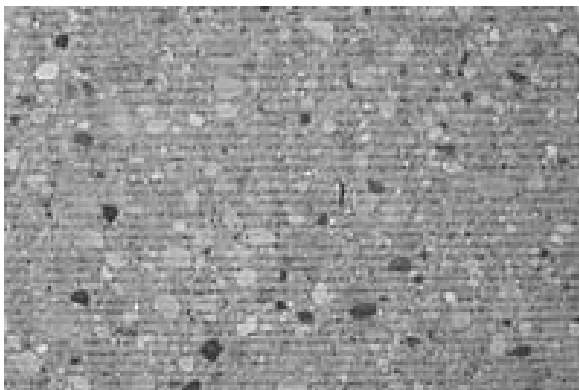

Figure 5-1 Concrete pavement surface after diamond grinding

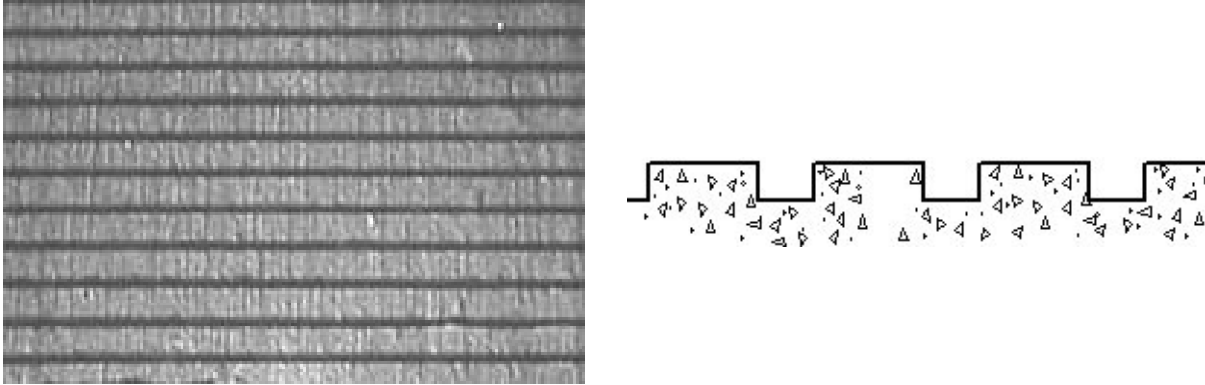

Figure 5-2 Concrete pavement surface after diamond grooving.

### 5.1.2 Purpose

#### Diamond Grinding

The most common reason for diamond grinding is to remove roughness caused by excessive faulting of pavement joints. However, if load transfer at the joints and cracks is not restored, faulting will most likely re-occur. Faulting at a joint is illustrated in Figure 5-3. A straightedge is used to measure the difference in elevation between the two adjacent slabs. In such cases diamond grinding can still be used as a short-term solution.



Figure 5-3 Faulting at a joint (FHWA, 2006)

Diamond grinding has also been proven effective in restoring smoothness and skid resistance on existing concrete pavements. On new pavements, it can be used to correct initial roughness due to construction problems and provide a uniform skid resistance and appearance. It is also being studied as a method for reducing noise generated by tire-pavement interaction (see Caltrans website <http://www.dot.ca.gov/hq/oppd/pavement/qpavement.htm> for the latest information).

It is important to recognize that diamond grinding can only be used to restore some of the functional characteristics of the pavement such as smoothness and skid resistance. If the pavement has structural or material deficiencies, diamond grinding will not repair or improve any of these defects. Diamond grinding should be used with discretion and only when needed, because it also reduces pavement thickness which can affect long-term pavement performance.

## Diamond Grooving

Diamond grooving is a surface restoration procedure which can be performed on both PCC and hot-mix asphalt pavements. This procedure involves the use of diamond saw blades with a typical spacing of  $\frac{3}{4}$  inch (19 mm) on centers to cut parallel grooves into the pavement surface. Grooving improves drainage characteristics of a pavement, as well as provides a surface with excellent braking traction.

Caltrans requires the grooving blades to be 0.095 inch  $\pm$  0.005 inch wide, and they shall be spaced  $\frac{3}{4}$  inch on center. The grooves shall be cut not less than  $\frac{1}{8}$  inch or more than  $\frac{1}{4}$  inch deep (Caltrans, 2006).

Diamond grooving can be performed either transversely or longitudinally. Transverse grooving is not common on highway pavements due to construction difficulties (mainly traffic control), even though this technique provides the most direct drainage channel of water on the pavement. Longitudinal grooving to improve drainage characteristics is not as effective as transverse grooving, but it does provide a channel for water and produces a proper tracking effect on vehicles on horizontal curves, thus reducing skidding crashes.

Diamond grooving should only be applied to pavements with sound structural and functional characteristics. Likewise, grooving should only be applied to pavement sections where wet weather crashes occur, not to an entire project except when the number of accidents throughout the project is significant.

### 5.1.3 Advantages

#### Diamond Grinding

When compared to other pavement restoration alternatives, diamond grinding has the following advantages:

- Cost effective – when balancing the cost of the CPR technique with the end result in terms of years of extended pavement life.
- Can be accomplished during off-peak hours with short lane closures and without encroaching into adjacent lanes.
- Pavements may be re-ground up to 2 or 3 times without significantly affecting the structural capacity of the pavement structure.
- Grinding in one lane does not require grinding of the adjacent lane which may have acceptable surface characteristics.
- Eliminates the need for taper which is required with overlay alternatives at highway entrances, exits, and side streets.
- Does not affect overhead clearances underneath bridges or hydraulic capacities of curbs and gutters on municipal streets.

#### Diamond Grooving

Some benefits of diamond grooving include:

- A cost-effective procedure for restoring surface texture. Diamond grooving provides a significant increase of the pavement's macrotexture.
- A proven procedure to reduce wet weather accidents by providing channels for the water to drain, as well as improving the frictional resistance to braking action through transverse grooves or by tracking vehicles within the grooves around curves on longitudinal grooves.



### 5.1.4 Limitations

#### Diamond Grinding

Some of the limitations associated with diamond grinding are:

- Faulting of the pavement joints will most likely reoccur if load transfer is deficient. If load transfer is not restored by other concrete pavement restoration techniques, such as dowel bar (load transfer) retrofit or undersealing, it will continue to cause problems.
- It does not correct any structural problems (e.g., slab cracking) or material problems (e.g., reactive aggregates).
- It reduces pavement thickness which could affect pavement fatigue performance. Grinding of concrete pavements to less than 8- or 9-inches [200-230 mm] in thickness is not advisable, because reduced pavement thickness will not provide sufficient structural capacity and will lead to pavement rupture and cracking under heavy vehicle loadings.

#### Diamond Grooving

The main disadvantage of longitudinal grooving is the “wobble” (small lateral movements) that small vehicles and motorcycles may encounter while driven on grooved pavements. This problem can be mitigated by limiting the groove spacing to  $\frac{3}{4}$  inch (20 mm) and using 0.125 in (3 mm) wide grooves (FHWA, 2004).

## 5.2 DESIGN AND SPECIFICATION

### 5.2.1 Terminology

The following terminology is used with diamond grinding and grooving:

- Depth – the depth of the saw cut grooves; sometimes also referred to as height.
- Land Area – the distance between consecutive grooves.
- Groove – the width of the saw cut groove or the width of the diamond blade.

The three terms are graphically illustrated in Figure 5-4:

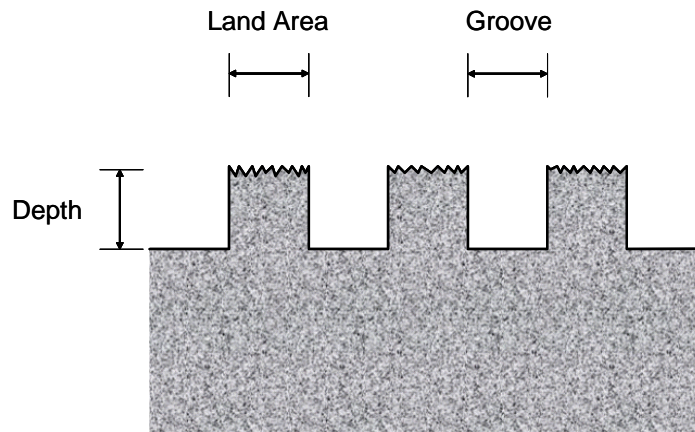

Figure 5-4 Diamond grinding and grooving terminology (FHWA, 2005)

### 5.2.2 Design Parameters

#### Diamond Grinding

The three design parameters shown in Figure 5-4 vary over a fairly narrow range of values. The groove is usually 0.10-0.13 inches (2.5-3.5 mm) wide with a depth of 0.05 to 0.2 inches (1.5 to 5 mm). The land area, however, was found to have an effect on the frictional resistance of the pavement. For optimum results, a higher land area or wider blade spacing is recommended for concrete pavements that contain softer aggregate such as limestone. For harder aggregates, a narrower blade spacing produces the best results.

The values recommended by the Federal Highway Administration (FHWA, 2005) and the Foundation for Pavement Preservation (FP<sup>2</sup>) for the three design parameters are in general agreement with the values given in Table 5.1, which are typically used in California and described in Caltrans SSP 42-050:

Table 5-1 Typical values for diamond grinding design in California

Parameter	Value
<i>Groove</i>	0.08 – 0.12 inch (2 – 3 mm)
<i>Depth</i>	0.06 – 0.08 inch (1.5 – 2 mm)
<i>Number of Grooves</i>	55 to 60/ft (180 – 200 / m)

The contractor is normally given the option to select the number of blades best suited for the job. Although increasing the spacing between blades may improve the frictional characteristics of concrete pavement surfaces containing softer aggregates, light vehicles and motorcycles may experience vehicle tracking. Tightening blade spacing may reduce this type of effect (FHWA, 2004).

#### Diamond Grooving

Table 5.2 provides recommended dimensions for diamond grooving. These dimensions have proven to be the most effective for highways (FHWA, 2004).

Table 5-2 Recommended dimensions for diamond grooving design (FHWA, 2004)

Parameter	Value
<i>Groove</i>	0.125 inch (3 mm)
<i>Depth</i>	0.125 – 0.25 inch (3 – 6 mm)
<i>Distance between Grooves</i> (center to center)	0.75 inch (20 mm)

### 5.2.3 Specifications

The Caltrans specification for diamond grinding is SSP 42-050, “Grind Existing Concrete Pavement” and for diamond grooving is SSP 42-010, “Groove Existing Concrete Pavement”. Section 42 of the

Caltrans Standard Specifications includes descriptions for both grinding and grooving. This document can be downloaded at:

[http://www.dot.ca.gov/hq/esc/oe/specifications/std\\_specs/2006\\_StdSpecs/2006\\_StdSpecs.pdf](http://www.dot.ca.gov/hq/esc/oe/specifications/std_specs/2006_StdSpecs/2006_StdSpecs.pdf)

In summary, the following performance criteria have to be met by the contractor for diamond grinding:

- The ground surface at transverse joints or cracks shall be tested with a 12-foot ± 2½ inch (3.5 m ± 0.06 m) long straightedge laid on the pavement parallel to the centerline with its midpoint at the joint or crack. The surface shall not vary by more than 0.01 feet (3 mm) from the lower edge of the straightedge.
- Cross-slope uniformity and positive drainage shall be maintained across the entire traveled way and shoulder. The cross-slope shall be uniform so that when tested with a 12-foot ± 2½ inch (3.5 m ± 0.06 m) long straightedge placed perpendicular to the centerline, the ground pavement surface shall not vary more than ¼ inch (6 mm) from the lower edge of the straightedge.
- After grinding has been completed, the pavement surface shall be profiled in conformance with the requirements of Section 40-1.10, "Final Finishing," of the Standard Specifications. Two profiles shall be obtained in each lane approximately 3 feet (0.9 m) from the lane lines. The average profile index shall be determined by averaging the two profiles in each lane. Additional grinding shall be performed, where necessary, to bring the ground pavement surface within the Profile Index requirements specified in Section 40-1.10, "Final Finishing," of the Standard Specifications.

Additional information in terms of grinding equipment and operation is provided in SSP 42-050 and should be followed during construction.

#### 5.2.4 Typical Item Codes

Typical Caltrans item codes for a diamond grinding project are given in Table 5-3.

Table 5-3 Typical item codes for a diamond grinding project

Item Code	Description
066145	Remove pavement markers
074017	Prepare water pollution control program
074020	Water pollution control
074042	Temporary concrete washout (portable)
120090	Construction area signs
120100	Traffic control system
128650	Portable changeable message sign
413111	Repair spalled joints
420201	Grind existing concrete pavement
420102	Groove existing concrete pavement
413114	Replace joint seal (existing concrete pavement)

*Note: The Standard Special Provisions and the PS&E Guide must be followed for specific item codes proposed for the project.*

Caltrans Standard Materials and Supplemental Work Item Codes can be found at the following web site:

[http://i80.dot.ca.gov/hq/esc/oe/awards/#item\\_code](http://i80.dot.ca.gov/hq/esc/oe/awards/#item_code)

### 5.3 PROJECT SELECTION

#### Diamond Grinding

In the decision process, and depending on the pavement restoration problem to be addressed, the major questions to be answered are:

- Is diamond grinding going to solve the underlying problem?
- Is the pavement a good candidate for diamond grinding (i.e., no structural deficiencies)?
- What is the expected remaining service life of the pavement after diamond grinding?

Guidelines to help the designer find the answer to each of the above questions are provided in the following sections.

#### Diamond Grooving

Diamond grooving is typically applied to localized areas instead of an entire project length. Information on wet weather crashes, as well as surface friction data for the section to be restored, is needed to evaluate whether diamond grooving is the right treatment to be applied.

##### 5.3.1 Applications

Question: Is diamond grinding a solution to the specific pavement deterioration problem you are looking to address?

Answer: Diamond grinding is known to improve the functional properties of jointed plain concrete pavements in many ways:

- Improves skid resistance and reduces the risk of hydroplaning (safety).
- Corrects wheelpath rutting caused by chain wear in cold climatic regions.
- Corrects faulting at joints and cracks if there are no voids at the joints.
- Corrects permanent slab warping at the joints.
- Corrects built-in construction or rehabilitation roughness.
- Improves drainage by correcting transverse slope.
- Reduces noise from tire-pavement interaction.

#### Faulting at Joints and Cracks

Excessive faulting of transverse joints and cracks is the most common reason for grinding jointed plain concrete pavements (JPCP). In general, several “ingredients” are necessary for faulting to occur: heavy traffic loads; insufficient load transfer between adjacent slabs; free moisture in the pavement structure; and an erodible base or subgrade material. Under the action of traffic, moisture is ejected from beneath the leave slab, carrying fines from the base or subgrade material and eventually resulting in a void. The fines are usually deposited under the approach slab causing it to lift slightly. This mechanism of distress is illustrated in Figure 5-5 and was discussed in detail in Section 1.2.3.

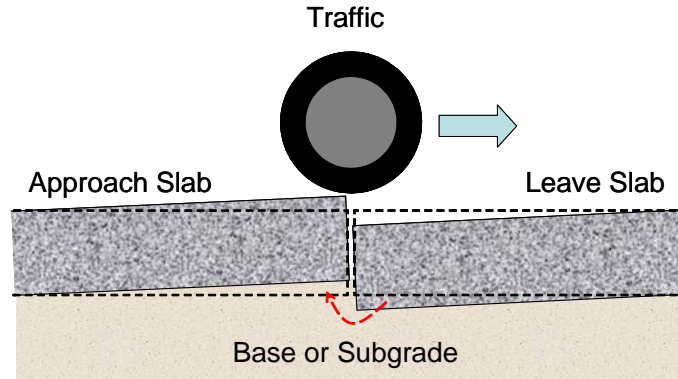

Figure 5-5 Faulting mechanism

Road users first notice faulting when the average difference in elevation between adjacent slabs (faulting) reaches about 0.1 inch (2.5 mm). This is where grinding for faulting is most likely justified and successful. In general, diamond grinding should be done before faulting reaches 0.16 inches (4 mm) or more. If the average faulting is greater than 1/2 inch (13 mm), depending on traffic level, the pavement may be beyond the window of opportunity for a successful diamond grinding project.

### Slab Warping at Joints

In dry climates, slabs can become permanently warped at the joints. Long joint spacings and stiff base support may result in curled slabs that are higher at the joints than at mid-panel, resulting in a bumpy, rough ride. If there are no structural deficiencies, diamond grinding can be used to restore smoothness and level off the surface of warped slabs. In such cases, warping is not likely to re-occur.

### Spot Grinding

If the surface of a newly constructed JPCP pavement does not meet smoothness specifications, diamond grinding can be used to eliminate construction induced (“built-in”) roughness. Depending on the specification requirements and cost-effectiveness, either full lane or spot grinding can be performed.

Work associated with partial- and full-depth slab repairs may also result in increased roughness, typically because of differences in elevation between the repair areas and the existing pavement. Diamond grinding can be used to blend repair areas with the original surface and restore ride quality. For widening projects, grinding of adjacent lanes may also be required.

### Skid Resistance and Hydroplaning

Frictional characteristics of polished surfaces can be restored by diamond grinding. Increasing the macrotexture of the concrete surface the skid resistance is improved. In addition, diamond grinding provides directional stability by tire tread pavement-groove interlock.

The potential for hydroplaning is also reduced by grinding; for example the grooves in the pavement provide room for the water on the pavement.

### **Tire-Pavement Interface Noise**

Tire-pavement noise is generally directly correlated with overall longitudinal roughness. Diamond grinding retextures worn and tined surfaces with a longitudinal texture, reduces roughness, and usually provides a quieter ride. For the latest information on quieter pavements, please see Caltrans website:

<http://www.dot.ca.gov/hq/oppd/pavement/qpavement.htm>

### **Restoring Transverse Slope**

Diamond grinding can be used to restore the pavement cross-slope. For example, in areas where studded tires or tire chains are used, the surface of the pavement can be worn and need repair. This form of rutting increases the amount of water trapped in the wheelpaths during rainy weather, thereby creating hazardous conditions that involve decreased visibility due to spray and a greater possibility of hydroplaning. Diamond grinding can be used to remove wheel path ruts and reduce the possibility of hydroplaning.

#### *5.3.2 Project Evaluation*

Question: Is the pavement a good candidate for diamond grinding?

Answer: Yes, if there is a need to restore ride quality and skid resistance and the pavement has not deteriorated so much that it is no longer cost effective to grind. However—if the existing pavement is structurally deficient, or suffers from durability problems such as alkali-aggregate reactivity, an overlay or reconstruction may be more appropriate.

### **Symptoms of Structural/Materials Deficiencies**

- Severe drainage or erosion problems, as indicated by significant faulting (greater than ½ inch [13 mm]) or pumping, should be corrected prior to grinding.
- Significant slab replacement (10% of the lane) and repair may be indicative of continuing progressive structural deterioration that grinding would not repair.
- The presence of progressive transverse slab cracking and corner breaks indicates a structural deficiency in the pavement. Slab cracking, and the faulting of these cracks, will continue after grinding if load transfer is not restored prior to grinding.
- Rigid pavements suffering from durability problems, such as alkali-aggregate reactivity, should not be rehabilitated through grinding.
- Joints and transverse cracks with a deflection load transfer (usually measured with a Falling Weight Deflectometer) of less than 60 percent should be corrected in order to restore load transfer prior to diamond grinding.

Diamond grinding may still be used as a short-term solution to improve roughness and friction on a structurally deficient pavement until a more comprehensive repair or reconstruction of the pavement can be undertaken.

### **Window of Opportunity**

Diamond grinding is a cost effective treatment when applied at the “right time, on the right project.” If the treatment is applied too early or too late in the life of a project, its benefits may be diminished or the cost of the treatment may be unnecessarily high. The “window of opportunity” refers to the period

of time during which diamond grinding will produce the expected benefits (significantly extending service life) at a competitive cost.

To better define the “window of opportunity,” triggers and limits are specified, usually in terms of faulting, roughness (IRI), skid resistance, or joint load transfer. Trigger values indicate when a highway agency should consider diamond grinding to restore ride quality. Limiting values for diamond grinding define the point when the pavement has deteriorated so much that it is no longer cost effective to grind.

Tables 5-4 and 5-5 provide trigger and limit values for diamond grinding recommended by FHWA (2006) for different types of pavements and traffic volumes. Caltrans is currently in the process of developing these values for pavement preservation.

Table 5-4 Trigger values for diamond grinding (FHWA, 2006)

Traffic Volumes*	JPCP			CRCP		
	High	Med	Low	High	Med	Low
Faulting, inches – avg. (mm – avg.)	0.08 (2.0)	0.08 (2.0)	0.08 (2.0)	N.A.		
Skid Resistance	Minimum Local Acceptable Levels					
PSR (not used in CA)	3.8	3.6	3.4	3.8	3.6	3.4
IRI in/mi (m/km)	63 (1.0)	76 (1.2)	90 (1.4)	63 (1.0)	76 (1.2)	90 (1.4)

\*Volumes: High ADT>10,000; Med 3000<ADT<10,000; Low ADT <3,000

Table 5-5 Limit values for diamond grinding (FHWA, 2006)

Traffic Volumes*	JPCP			CRCP		
	High	Med	Low	High	Med	Low
Faulting, inches – avg. (mm – avg.)	0.35 (9.0)	0.5 (12.0)	0.6 (15.0)	N.A.		
Skid Resistance	Minimum Local Acceptable Levels					
PSR (not used in CA)	3.0	2.5	2.0	3.0	2.5	2.0
IRI in/mi (m/km)	160 (2.5)	190 (3.0)	222 (3.5)	160 (2.5)	190 (3.0)	220 (3.5)

\*Volumes: High ADT>10,000; Med 3000<ADT<10,000; Low ADT <3,000

The general guidelines historically used for grinding include:

- The pavement needs a smoother ride for the traveling public (the Highway Design Manual uses an IRI of 160 in/mile [2.5 m/km] as threshold; CAPM starts at IRI of 150 in/mi [2.4 m/km]);
- Faulting is 0.1 inch (2.5 mm) or greater;
- Rutting is 0.1 inch (2.5 mm) or greater;
- Friction coefficient is less than 0.30;
- Projects with >10% slab replacement may not be cost effective;



- Joints with poor load transfer should be dowel bar retrofitted (this option results in a lower life cycle cost than other effective alternatives).

Other project specific factors, such as the hardness of the aggregate, may have a direct impact on the cost of grinding. Grinding a pavement with extremely hard aggregate (such as trap rock or river gravel) takes more time and effort than grinding a pavement with a softer aggregate (such as limestone, although not typically used in California).

In summary, the selection of a good candidate project for diamond grinding and concrete pavement restoration (CPR) in general involves both engineering and economics. The functional and structural condition of the pavement, the cost, and the timing of the treatment are all important factors to be weighed in the decision process.

### 5.3.3 *Expected Lives of Treatments*

Question: How many years of service life extension can be gained from diamond grinding?

Answer: Nationwide, the average life extension achieved through diamond grinding is estimated at about 14 years. In California, the numbers are even better, with an average of 16-17 years (Caltrans, 2005). However, note that the condition and age of the existing pavement can significantly affect the expected lifespan of a diamond grinding project.

A Caltrans-sponsored research study intended to better quantify the expected longevity or “survival” of diamond ground PCC pavements and the overall effectiveness under California conditions and construction practices was completed in 2005 (Caltrans 2005). The study found that nationwide, the average (50% reliability) longevity of a diamond ground project is around 14 years, or about 11 years at an 80% certainty (reliability) level.

Data were obtained from several statewide diamond grinding projects. Based on these data, a plot of the average expected increase in roughness with time was developed and is reproduced in Figure 5-6. The increase in IRI as a ratio of the initial IRI is used as a measure of pavement deterioration after grinding. A ratio of 1.78 is used as the trigger for rehabilitation. On the same plot, curves corresponding to the 70%, 80% and 90% reliability levels are shown.

As illustrated in Figure 5-6, the average life of the diamond grinding in California (i.e. a 50% reliability prediction) is 16.8 years, at an average IRI ratio of 1.78. At 80% reliability, the extension in service life is about 14 years. This study concludes that these results are quite reasonable, since the climatic conditions in California are comparatively favorable for longer-lasting rigid pavement performance.

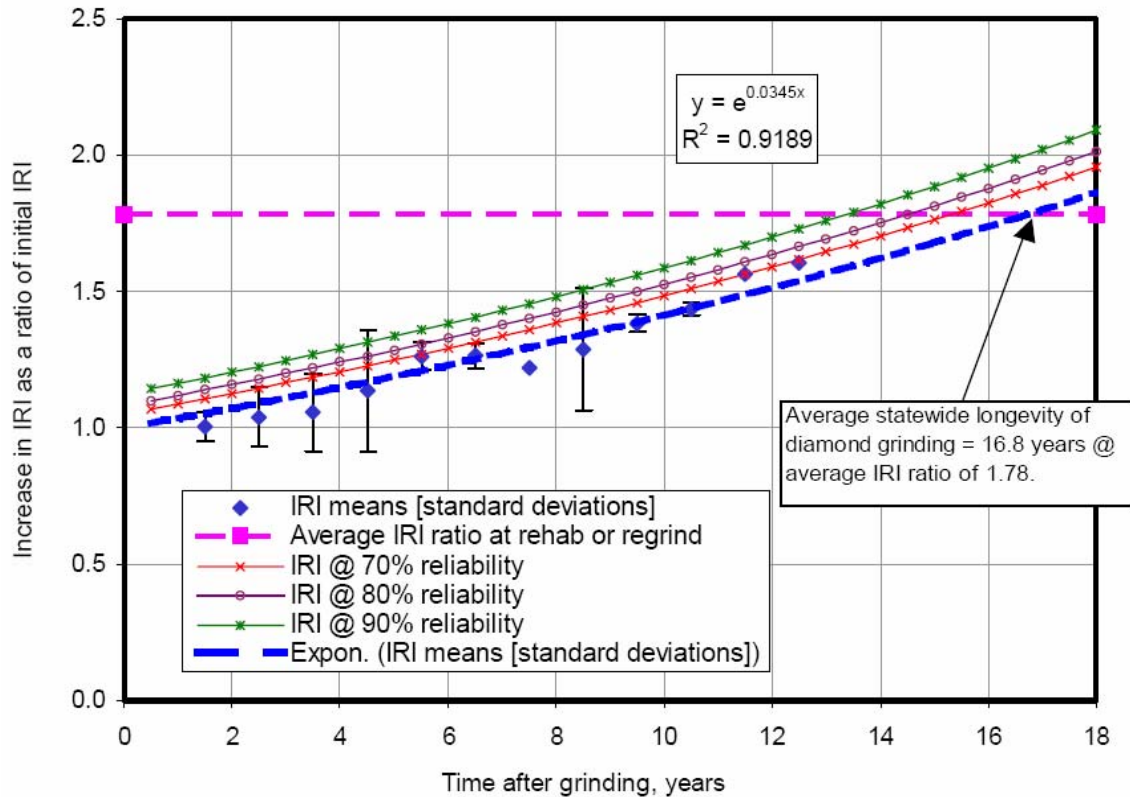

Figure 5-6 Reliability levels for the expected survivability of California diamond ground pavements (Caltrans, 2005)

Although the thickness of PCC slabs is reduced through grinding, a recent study shows that due to the increase in the strength of the concrete with time, the reduction in stiffness associated with the reduced thickness may not significantly affect the fatigue life of the pavement (Rao et. al 1999). In most cases, concrete pavements can be re-ground up to 3 times. However, caution must be made to avoid grinding the pavement too thin or when structural deficiencies occur.

## 5.4 CONSTRUCTION PROCESS

The construction process involves traffic control, the grinding or grooving process, and quality control & assurance of the finished pavement surface. Each of these aspects is discussed in this section of the guide. In addition, a description of diamond grinding and grooving equipment, strategies to insure productivity, and guidelines for the correct sequence of work when performing diamond grinding and grooving—in parallel with other CPR techniques—are provided.

### 5.4.1 Traffic Control and Safety

Typically, grinding and grooving are conducted on multi-lane facilities using a mobile single-lane closure, allowing traffic to be carried on the adjacent lanes. With proper work sequencing, the contractor can perform grinding and other CPR techniques while maintaining traffic on adjacent lanes and enabling the pavement to be fully opened to traffic during peak hours. When setting up traffic control, the following aspects should be considered (FHWA, 2005):

- Verify that signs and devices match the traffic control plan presented in the contract documents.
- Verify that the setup complies with the Federal Manual on Uniform Traffic Control.
- Insure that local agency traffic control procedures and use of devices are followed.
- Verify that the repaired pavement is not opened to traffic until all equipment and personnel have been removed from the work zone.
- Verify that signs are removed or covered when they are no longer needed.
- Verify that any unsafe conditions are reported to a supervisor (contractor or agency).

Depending on project location, size, and amount of work, one of the following types of traffic control alternatives may be considered:

- Complete roadbed closure
- Continuous lane closure
- Weekend closure
- Nighttime closure

A more detailed description on traffic control is provided in Section 1.5.4.

### 5.4.2 Equipment

A schematic of the grinding machine is presented in Figure 5-7. Actual grinding is done through the dual action of the grinding head: Rotation and pressure against the pavement surface. A front view of a typical grinding machine is shown in Figure 5-8. In Figure 5-9, the same machine is shown during grinding. The grinding head consists of closely spaced diamond blades. Typical blades are shown in Figure 5-10. In Figure 5-11 the cutting head (or grinding head) is shown with the diamond blades mounted. The cutting head typically has a width of 4 feet.

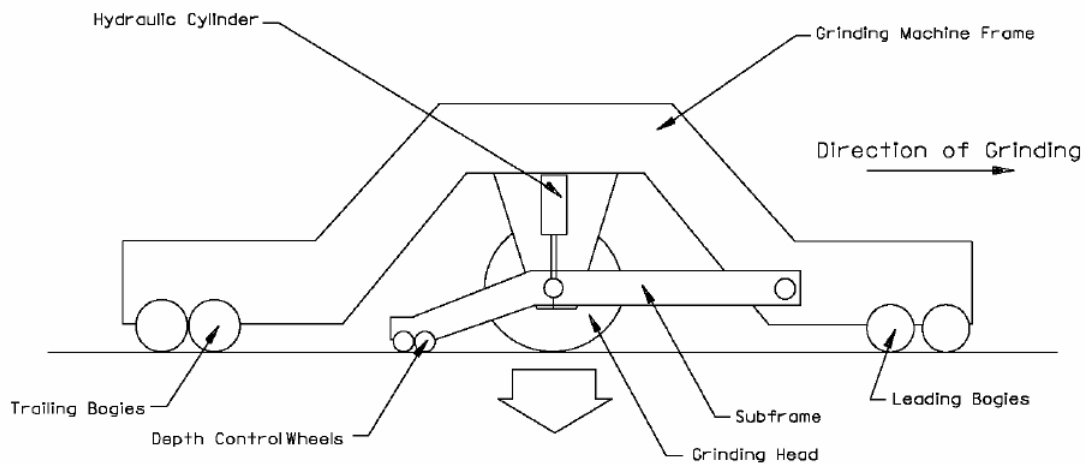

Figure 5-7 Schematic of grinding machine (MnDOT, 2005)



Figure 5-8 Typical grinding machine, front view (Courtesy of Caltrans)



Figure 5-9 Grinding process (Courtesy of Caltrans)



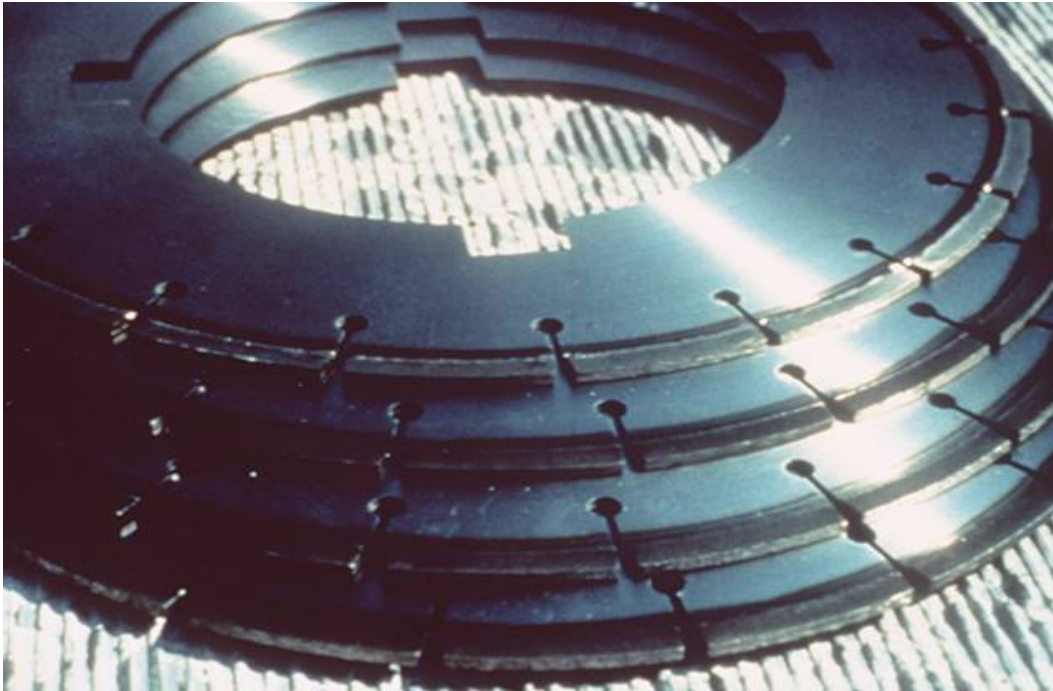

Figure 5-10 Diamond blades (Courtesy of Caltrans)

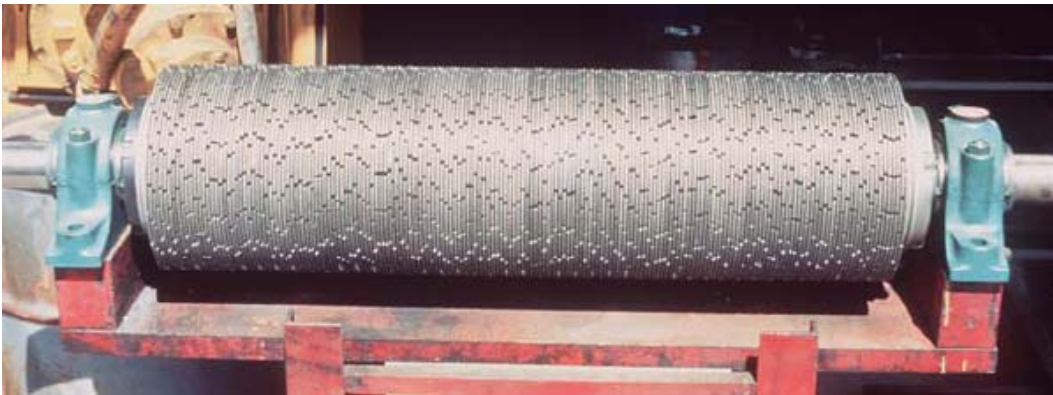

Figure 5-11 Typical cutting head (Courtesy of Caltrans)

In general, three or four passes of one or more grinding machines are necessary to cover the entire width of a lane. The desired texture is produced using a spacing of 50 to 60 blades per foot (165 to 200 blades per meter). The texture of the pavement surface after diamond grinding is shown in Figures 5-12 and 5-13.



Figure 5-12 Pavement surface after diamond grinding (Courtesy of IGGA)



Figure 5-13 Pavement surface texture behind grinding head (Courtesy of Caltrans)

### 5.4.3 Productivity

According to the American Concrete Pavement Association (ACPA), the ride and frictional qualities of the finished surface are not significantly affected by the direction of grinding (ACPA, 2000). However for best results, grinding should be started and ended perpendicular to the pavement centerline and maintained parallel to the centerline between the starting and ending points. To the extent possible, grinding should be performed continuously along a traffic lane for the entire lane width, including lane lines.

The width of the cutting head is generally about 4 feet (1.2 m). To grind the entire width of one lane, more than a single pass of the grinding equipment will be required. It is recommended that the overlap between adjacent passes be no more than 2 inches (50 mm). To increase productivity and minimize traffic closures on large projects, several machines are usually used together to allow an entire lane width to be covered in one pass.

Grinding equipment should have a long reference beam so the existing pavement can be used as a reference. By blending the highs and lows, excellent riding quality can be obtained with a minimum depth of removal. Generally, it is required that a minimum of 95 percent of the area within any 3 ft by 100 ft (1 m by 30 m) test area be textured by the grinding operation.

Immediately after grinding, thin fins remaining from the area between saw blades generally remain on the finished surface. These fins should break free easily with one or two passes of a roller or under normal traffic. If this doesn't happen, the grinding head may be excessively worn or the blade spacing may need to be reduced.

### 5.4.4 Slurry Removal

Disposal of portland cement concrete pavement grooving or grinding residue shall be in conformance with the provisions in Section 42, "Groove and Grind Pavement," of the Caltrans Standard Specifications and the special provisions. The Contractor shall include water pollution control measures to address the handling of the grinding pavement residue within the Storm Water Pollution Prevention Plan or Water Pollution Control Program, as specified in "Water Pollution Control" of the special provisions (SSP 42-600).

### 5.4.5 Sequencing Work

Diamond grinding is usually performed in conjunction with other repairs. The sequence in which the repairs are performed is very important. Typically, slab repairs (full or partial depth) and load transfer restoration are performed first. If edge drains are in need of retrofit, they should precede slab repairs. Diamond grinding should be performed after spall repairs and slab replacements to ensure uniform smoothness and frictional properties of the existing and repaired pavement. The only component of the pavement that may be affected by grinding is the sealing of joints and cracks. For this reason, crack and joint sealing should be performed after grinding is completed. A schematic of the sequence of CPR techniques, as recommended by the FHWA and FP<sup>2</sup> is presented in Figure 5-14 (FHWA, 2005).



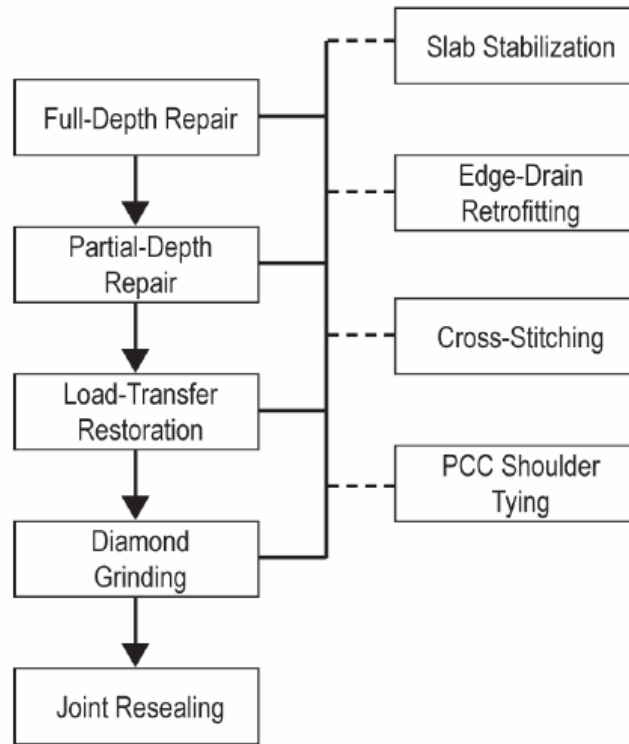

Figure 5-14 Sequence of repairs in the concrete pavement restoration process (FHWA, 2005)

#### 5.4.6 Job Review - Quality Issues

The quality of diamond grinding is called acceptance testing, which is usually assessed through measurements of roughness and/or skid resistance after grinding is completed.

##### **Roughness**

The terms roughness, smoothness and ride quality are used interchangeably to describe how the pavement compares to an ideal pavement with a perfectly smooth surface. The most commonly used profile measuring device for grinding operations is the California profilograph, which is used by Caltrans, but several other different devices are available and may be used. It is common to make profile measurements before and after grinding to better quantify the benefit of grinding. The equipment used in acceptance testing should be the same as that used in the initial evaluation and should be specified along with procedures to be followed in acceptance testing as described in Section 5.2.3.

##### **Skid Resistance**

Pavement skid resistance can also be used to assess the quality of diamond grinding. Skid resistance values obtained after diamond grinding can be compared to values obtained prior to grinding to document improvements.

Nationally, skid resistance is generally measured using either a standard ribbed tire (ASTM E 501) or a standard smooth tire (ASTM E 524). Caltrans measures surface skid resistance with the California portable skid tester following California Test Method 342 (5). Note that pavements with harder



aggregates such as granite will maintain adequate surface friction longer than pavements with softer aggregates.

**Slurry Disposal**

Disposal of residues from the grinding or grooving operation should be in conformance with the provisions described in Section 42, "Groove and Grind Pavement," of the Caltrans Standard Specifications and Standard Special Provisions 42-600. Water pollution control measures or a water pollution program should be developed to address the handling and disposal of grinding residue.

**5.5 PROJECT CHECKLIST AND TROUBLESHOOTING GUIDE**

The project checklist and the troubleshooting guide, included in this section, provide important information which can help solve difficulties and improve performance in diamond grinding and grooving repairs. The project checklist describes important aspects of a grinding project, such as preliminary responsibilities, material and equipment requirements, project inspection responsibilities, and cleanup responsibilities, all of which should be considered in order to promote a successful project. The troubleshooting guide describes common problems encountered during the project and their solutions.

*5.5.1 Project Checklist*

The following checklist was primarily based on guidelines from the FHWA Pavement Preservation Checklist Series ([http://www.fhwa.dot.gov/pavement/pub\\_details.cfm?id=351](http://www.fhwa.dot.gov/pavement/pub_details.cfm?id=351)) and the FHWA/NHI Course: Pavement Preservation Design and Construction of Quality Preventive Maintenance Treatments.

<b>Preliminary Responsibilities</b>	
<b>Document Review</b>	<ul style="list-style-type: none"> <li>✓ Bid/project specifications and drawings</li> <li>✓ Special provisions</li> <li>✓ Agency requirements</li> <li>✓ Regulatory agency requirements/permits</li> <li>✓ Traffic control plan</li> <li>✓ Equipment specifications</li> <li>✓ Material safety data sheets (if required for concrete slurry)</li> </ul>
<b>Project Review</b>	<ul style="list-style-type: none"> <li>✓ Verify that pavement conditions have not significantly changed since the project was designed.</li> <li>✓ Joints and transverse cracks sustaining severe faulting (equal to or greater than ½ in. [13 mm]) or displaying evidence of pumping (e.g., surface staining or isolated wetness) are potential candidates for load transfer restoration with dowels prior to diamond grinding.</li> <li>✓ Verify that structural repairs are completed in the proper sequence (Figure 5-14).</li> </ul>
<b>Equipment Inspections</b>	
<b>Diamond-Grinding Machine</b>	<ul style="list-style-type: none"> <li>✓ Verify that the diamond-grinding machine meets requirements of the contract documents for weight, horsepower, and configuration.</li> <li>✓ Verify that the blade spacing on the diamond grinding cutting head meets requirements of the contract documents.</li> <li>✓ Verify that the vacuum assembly is in good working order and capable of removing concrete slurry from the pavement surface.</li> </ul>
<b>Profilograph or Profiler</b>	<ul style="list-style-type: none"> <li>✓ Verify that the profilograph or pavement profiler meets requirements of the contract documents.</li> </ul>

	<ul style="list-style-type: none"> <li>✓ Verify that the unit has been calibrated in accordance with manufacturer’s recommendations and contract documents.</li> <li>✓ Verify that the profilograph operator meets requirements of the contract documents for training/certification.</li> </ul>
<b>Others</b>	
<b>Weather Requirements</b>	<ul style="list-style-type: none"> <li>➤ Air and/or surface temperature should meet minimum agency requirements (typically 35 °F [2 °C] and rising) for diamond-grinding operations in accordance with contract documents.</li> <li>➤ Diamond grinding shall not proceed if icy weather conditions are imminent.</li> </ul>
<b>Traffic Control</b>	<ul style="list-style-type: none"> <li>✓ Verify that signs and devices match the traffic control plan presented in the contract documents.</li> <li>✓ Verify that the setup complies with the Manual on Uniform Traffic Control Devices (MUTCD) and the California Supplement to the MUTCD.</li> <li>✓ Verify that the repaired pavement is not opened to traffic until all equipment and personnel have been removed from the work zone.</li> <li>✓ Verify that signs are removed or covered when they are no longer needed.</li> <li>✓ Verify that any unsafe conditions are reported to a supervisor (contractor or agency).</li> </ul>
<b>Project Inspection Responsibilities</b>	
<b>Alignment</b>	<ul style="list-style-type: none"> <li>✓ Verify that diamond grinding proceeds in a direction parallel with the pavement centerline, beginning and ending at lines normal to the pavement centerline.</li> <li>✓ Verify that the transverse slope of the ground surface is uniform to the extent that no misalignments or depressions that are capable of ponding water exist. Project documents typically have specific measurable criteria for transverse slope that must be met.</li> </ul>
<b>Texture</b>	<ul style="list-style-type: none"> <li>✓ Verify that diamond-grinding results in a corduroy texture extending across the full lane width and complying with contract documents.</li> <li>✓ Verify that texturing cut into the existing pavement surface is in accordance with texturing requirements presented in the contract documents.</li> <li>➤ Verify that each application of the diamond ground texture overlaps the previous application by no more than the amount designated in the contract documents, typically 2 in (50 mm).</li> <li>➤ Verify that each application of the diamond ground texture does not exceed the depth of the previous application by more than the amount permitted in the contract documents, typically ¼ in (6 mm).</li> <li>✓ Verify on a daily basis that diamond-ground texture meets smoothness specifications.</li> </ul>
<b>Residues</b>	<ul style="list-style-type: none"> <li>✓ Verify that concrete slurry is adequately vacuumed from the pavement surface and is not allowed to flow into adjacent traffic lanes.</li> <li>✓ Verify that the grinding residue is handled in conformation with Caltrans SSP 42-600 and not discharged into any area forbidden by the contract documents or engineer. Concrete slurry from the grinding operation is typically collected and discharged at a disposal area designated in the contract document.</li> </ul>

### 5.5.2 Troubleshooting Guide

The following guide summarizes some of the common problems encountered during the grinding or grooving process. It also includes typical causes of these problems and possible solutions.

Problem	Causes and solutions
“Dogtails” (pavement areas that are not ground due to a lack of horizontal overlap).	Causes: <ul style="list-style-type: none"> <li>• These are primarily caused by weaving during the grinding operation (IGGA/ACPA, 2001).</li> </ul> Solution: <ul style="list-style-type: none"> <li>• Maintaining the required horizontal overlap (typically 2 in [50 mm] maximum) between passes and steady steering by the operator will avoid the occurrence of dogtails.</li> </ul>
“Holidays” (areas that are not ground).	Cause: <ul style="list-style-type: none"> <li>• Isolated low spots in the pavement surface.</li> </ul> Solution: <ul style="list-style-type: none"> <li>• Lower the grinding head and complete another pass. Typical specifications require 95 percent coverage for grinding texture and allows for 5 percent un-ground isolated areas.</li> </ul>
Poor vertical match between passes.	Cause: <ul style="list-style-type: none"> <li>• Inconsistent downward pressure. This is often obtained when unnecessary adjustments to the down-pressure are made.</li> </ul> Solution: <ul style="list-style-type: none"> <li>• A constant down-pressure should be maintained between passes to maintain a similar cut depth. A less than 0.12 in per 10 ft (3 mm per 3 m) vertical overlap requirement is often required (IGGA/ACPA, 2001).</li> </ul>
Too much or too little material removed near joints.	Causes: <ul style="list-style-type: none"> <li>• Expansion joints or other wide gaps in the pavement can cause the cutting head to dip if the leading wheels drop into the opening.</li> <li>• Slabs deflecting from the weight of the grinding equipment can cause insufficient material to be removed.</li> </ul> Solutions: <ul style="list-style-type: none"> <li>• Wide gaps can be temporarily grouted to provide a smooth surface.</li> <li>• If slabs deflect from the weight of the grinding equipment, lowering the grinding head may help, but stabilizing the slab or retrofitting dowel bars may be a better alternative (IGGA/ACPA, 2001).</li> </ul>
The fins that remain after grinding do not quickly break free.	Cause: <ul style="list-style-type: none"> <li>• This could be an indication of excessive wear on the grinding head, but most likely it is the result of incorrect blade spacing.</li> </ul> Solution: <ul style="list-style-type: none"> <li>• The grinding head should be checked for wear before or after each day of operation. If the cutting blades are not worn, the blade spacing should be reduced.</li> </ul>

Problem	Causes and solutions
Large amounts of slurry on the pavement during grinding.	<p>Cause:</p> <ul style="list-style-type: none"> <li>• Most likely this indicates a problem with the vacuum unit or skirt surrounding the cutting head.</li> </ul> <p>Solution:</p> <ul style="list-style-type: none"> <li>• If large amounts of slurry are left on the pavement, or slurry flows into adjacent traffic lanes or drainage structures, the surface grinding operations should be stopped. Inspect the equipment and make necessary repairs.</li> </ul>
Lack of horizontal overlap.	<p>Cause:</p> <ul style="list-style-type: none"> <li>• As with grinding operations, this is primarily caused by weaving during the grooving operation.</li> </ul> <p>Solution:</p> <ul style="list-style-type: none"> <li>• Lack of horizontal overlap or weaving during grooving operations may cause lighter vehicles and motorcycles to experience increased vehicle tracking. Maintaining the required horizontal overlap between passes and steady steering by the operator will avoid the occurrence of this problem.</li> </ul>
Isolated areas with inconsistent groove depth.	<p>Cause:</p> <ul style="list-style-type: none"> <li>• Isolated low spots in the pavement surface.</li> </ul> <p>Solution:</p> <ul style="list-style-type: none"> <li>• Although the effects of variable depth grooves are less readily apparent to traffic (no dip in the pavement surface is created), a uniform depth is desirable to ensure the intended drainage characteristics. The grooving head may need to be lowered in areas known to contain isolated low spots.</li> </ul>
Inconsistent groove depth near joints.	<p>Causes:</p> <ul style="list-style-type: none"> <li>• Expansion joints or other wide gaps in the pavement can cause the cutting head to dip if the leading wheels drop into the opening.</li> <li>• Slabs deflecting from the weight of the grooving equipment can cause insufficient material to be removed.</li> </ul> <p>Solutions:</p> <ul style="list-style-type: none"> <li>• Wide gaps can be temporarily grouted to provide a smooth surface.</li> <li>• If slabs deflect from the weight of the grooving equipment, lowering the grooving head may help, but stabilizing the slab or retrofitting dowel bars may be a better alternative.</li> </ul>
Large amounts of slurry on the pavement during grooving.	<p>Cause:</p> <ul style="list-style-type: none"> <li>• This indicates a problem with the vacuum unit or skirt surrounding the cutting head.</li> </ul> <p>Solution:</p> <ul style="list-style-type: none"> <li>• If large amounts of slurry are left on the pavement, or slurry flows into adjacent traffic lanes or drainage structures, the surface grooving operations should be stopped. Inspect the equipment and make necessary repairs.</li> </ul>
Light vehicles and motorcycles experience vehicle tracking:	<p>Cause:</p> <ul style="list-style-type: none"> <li>• Interaction between tire and pavement surface.</li> </ul> <p>Solution:</p> <ul style="list-style-type: none"> <li>• Reduce the spacing between the blades.</li> </ul>

## 5.6 KEY REFERENCES

- American Concrete Pavement Association, 1994. *Slab Stabilization Guidelines for Concrete Pavements*, Skokie, IL, 1994.
- American Concrete Pavement Association and International Grooving and Grinding Association, 2000. *Diamond Grinding and Concrete Pavement Restoration*, Concrete Pavement Technology, 2000.
- American Concrete Pavement Association, 2006.  
<http://www.pavement.com/PavTech/Tech/Fundamentals>, 2006.
- Caltrans, 2005. *The Effectiveness of Diamond Grinding Pavements in California*, Sacramento, California, May 2005.
- Caltrans, 2006. *Standard Specifications*, Publication Distribution Unit, Sacramento, California, May 2006.
- Federal Highway Administration, 2004. *Pavement preservation design and construction of quality preventive maintenance treatments*, National Highway Institute Course 131103, November 2004.
- Federal Highway Administration and the Foundation for Pavement Preservation, 2005. *Pavement Preservation Checklist Series, No 7, Diamond Grinding of Portland Cement Concrete Pavements*, Publication No. FHWA-IF-03-040, August 2005.
- Federal Highway Administration, 2006. *Concrete Pavement Rehabilitation Guide for Diamond Grinding*, <http://www.fhwa.dot.gov/pavement/concrete/diamond.cfm>, 2006.
- Minnesota Department of Transportation (MnDOT), 2005. *State Aid Concrete Pavement Rehabilitation (CPR) Best Practices Manual*, Report No. MN/RC – 2005-33, Research Services Section, St. Paul, Minnesota 55155, September 2005.
- Rao, Shreenath et al, 1999. *Longevity of Diamond-Ground Concrete Pavements*, Transportation Research Record No. 1684, Transportation Research Board, Washington, D.C., 1999.
- Stahl, Kirsten, 2006. *PCC Pavement Preservation and Maintenance*, Presentation at the Southern California Pavement Preservation Conference, Diamond Bar, California, May 2006.

*Disclaimer*

*The contents of this guide reflect the views of the authors who are responsible for the facts and accuracy of the data presented herein. The contents do not necessarily reflect the official views or policies of the State of California or the Federal Highway Administration. This guide does not constitute a standard, specification, or regulation.*

## CHAPTER 6 DOWEL BAR RETROFIT

This chapter describes a treatment technique for restoring load transfer efficiency through dowel bar retrofit. The material presented in this chapter has been taken largely from the FHWA/ACPA report “Concrete Rehabilitation – Guide to Load Transfer Restoration” (FHWA/ACPA, 1997) and the FHWA course notes from “Pavement Preservation Design and Construction of Quality Preventative Maintenance Treatments,” Module 3-5 – Load Transfer Restoration (FHWA, 2004). Other sources are cited as appropriate.

### 6.1 BACKGROUND

In jointed plain concrete pavements (JPCP), load transfer refers to the ability of transferring load from one slab across a joint or crack to the adjacent slab as traffic passes over the joint. The transfer occurs through a shear action. The shear load is transferred by a combination of interlocking of aggregate in the adjacent slabs and mechanical action of dowel bars (or other load transfer devices) if they are present.

Load transfer reduces stresses in the slab and also reduces deflections at the joint. Effective load transfer provides several benefits to rigid pavements:

- Slows or reduces development of pumping and faulting by reducing slab deflections.
- Decreases cracking within the slab by reducing tensile stresses.

Dowel bar retrofit is a process commonly used to restore load transfer at JPCP joints.

#### 6.1.1 Load Transfer Efficiency

Load Transfer Efficiency (LTE) is the numerical measure used to define the effectiveness of load transfer. LTE may be defined either in terms of the stress transferred or the displacement transferred across slabs. The most common and generally recommended method is to base LTE on measurement of the deflections of slabs on either side of a crack or joint during wheel loadings using the formula:

$$\text{LTE} = \frac{\Delta_U}{\Delta_L} \times 100 \quad (\text{Eq. 6-1})$$

where:

$\Delta_U$  = Deflection on the unloaded side of the joint

$\Delta_L$  = Deflection on the loaded side of the joint

If there is perfect load transfer, both slabs will deflect equally and the LTE value will be equal to 100 percent. Conversely if there is no load transfer, the deflection of the unloaded slab will be zero and the LTE will be zero percent. A displacement LTE of 70 percent or higher is generally considered to be satisfactory. Figure 6-1 schematically portrays effective and ineffective load transfer.

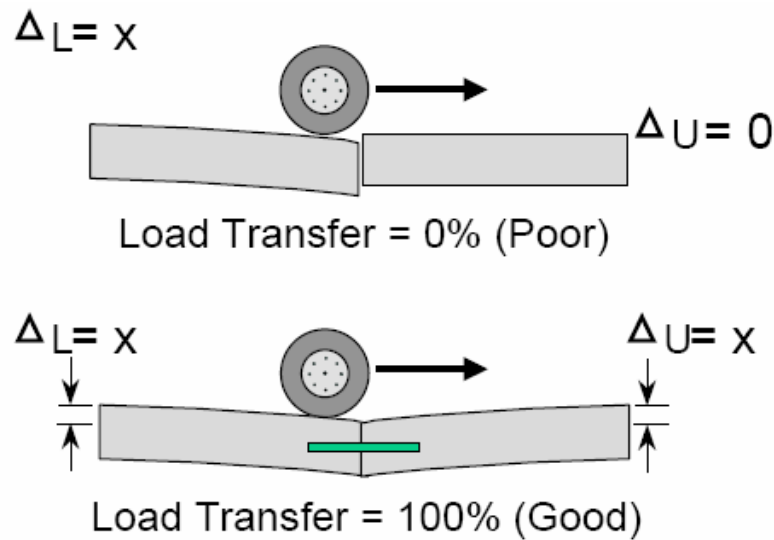

Figure 6-1 Load transfer (Caltrans, 2006a)

### 6.1.2 Measuring Load Transfer Efficiency

LTE measurements must be made with a device that can simulate heavy (truck) wheel loads. A Falling Weight Deflectometer (FWD) is commonly used to measure LTE as defined in Equation 6-1. Automated systems are available elsewhere that can measure and digitally record several miles of pavement per day depending on joint spacing (FHWA/NHI, 2004).

LTE measurements can vary significantly as the temperature of the pavement slabs change. At high temperatures the thermal expansion of the slabs causes the joints to close, thus LTE is increased by aggregate interlock. It is important that FWD deflection testing is conducted in the morning hours when ambient air temperatures are less than 70°F (21°C). This is probably the best time for measuring deflections and determining LTEs because the joints should not be as “tight” as they will be when the temperature rises. LTE measurements should be made in the outer wheel paths which are subject to the highest truck loads.

## 6.2 PURPOSE AND DESCRIPTION OF TREATMENT

Non-doweled, jointed plain concrete pavements (JPCP) depend on aggregate interlock to transfer load across joints. As these joints deteriorate through age and trafficking, aggregate interlock is lost and LTE decreases. Prior to 1998, Caltrans built concrete pavements without dowel bars and aggregate interlock was only method used to transfer load across joints. For doweled, jointed reinforced concrete pavements (JRCP), a similar loss in LTE can occur if existing dowel bars at the joints fail through corrosion, rupture, or deformation. Mid-panel transverse cracks of medium- to high severity generally have low LTE for both JPCP and JRCP.

Load transfer restoration (LTR) is the process of improving LTE of jointed plain concrete pavements by placing “load transfer” devices at joints or cracks to aid in the transfer of stresses across the joints or cracks. Dowel bar retrofit (DBR) is a method of LTR which installs new dowel bars in existing rigid pavements. It has been successfully used to increase LTE at both slab joints and mid-panel transverse slab cracks in JPCP (FHWA, 1991; FHWA/ACPA, 1997; Pierce et al, 2003; Caltrans,

2002b). The process entails cutting slots across the existing slab joints or transverse cracks, installing dowel bars in these slots, and then backfilling the slots with a non-shrink grout material. When properly installed, dowel bar retrofits have been shown to significantly improve LTE and prolong pavement life by 10-15 years by reducing faulting and further deterioration of joints and cracks (FHWA, 1991; FHWA/ACPA, 1997; Pierce et al, 2003; Caltrans, 2002b). DBR is often combined with diamond grinding to reduce faulting and other surface irregularities. Caltrans has used this technique with success, although some projects were not properly carried out which resulted in less successful results.

### 6.3 PROJECT SELECTION

Dowel bar retrofit (DBR) is best suited for pavements that are structurally sound, but exhibit low load transfer at joints and/or cracks. Pavements with little remaining structural life, as evidenced by extensive cracking (more than 10% stage 3 cracking) or with high severity joint defects are not good candidates for DBR. Two typical cases where DBR can be effective are shown below (FHWA/ACPA, 1997):

- An aging but structurally sound pavement, with adequate thickness but exhibiting significant load transfer loss due to lack of dowels, poor aggregate interlock and/or erosion of base, subbase, or subgrade below slab.
- A relatively young pavement in good or better condition but with the potential to develop faulting, working cracks, or corner breaks due to insufficient slab thickness, joint spacing greater than 15 feet (4.6 m), or inadequate joint load transfer.

#### 6.3.1 Factors to Consider

There are five major factors to consider when evaluating a potential project for DBR:

- Structural condition of the slabs
- Structural condition of the base
- Measured LTE values
- Magnitude of faulting
- Condition of joints and/or cracks

**Structural condition of the slabs:** Pavements should be in good structural condition to be candidates for DBR. Pavement slabs exhibiting D-cracking, alkali-silica reaction (ASR) or alkali-carbonate reaction (ACR) distress, multiple transverse cracking, or significant longitudinal cracking are poor candidates for DBR. In these cases, slab replacement should be considered. If more than 10 percent of the pavement slabs exhibit such structural defects, it may be more cost effective to remove and replace the entire pavement surface course (FHWA, 1996).

**Structural condition of base:** The pavement base should be in good structural condition to support the slabs. Slabs with a high deflection value at the joints are generally an indication of poor base condition.

**Measured LTE Values:** Pavements with average LTE of less than 60 percent are generally candidates for DBR (FHWA/ACPA 1997). As long as the slabs are structurally sound, a lower limit for applicability of DBR has not been established. In fact, joints with LTE as low as 10 percent have seen significant improvement in LTE after DBR (Pierce et al, 2003) if the dowels are properly installed.



**Magnitude of faulting:** Pavements with faulting > 0.10 in. (2½ mm) but < 0.5 in. (13 mm) and which are otherwise structurally sound are candidates for DBR. Faulting < 0.10 in. (2½ mm) does not warrant DBR. If faulting is greater than 0.5 in. (13 mm) and/or if the pavement is structurally inadequate, reconstruction should be considered (Pierce et al, 2003). LTE levels should also be considered in this process.

**Conditions of joints or cracks:** Joints or transverse cracks should exhibit low to moderate severity spalling, or better. DBR treatments require sound material near the joint or crack to ensure adequate transfer of load from one panel to another. Joints with high severity spalling are candidates for full-depth repair (see chapter 8).

Table 6-1 provides a summary of project selection criteria. Overall, when faulting is between 0.10 inch (2½ mm) and 0.5 inch (13 mm) with less than 10% of stage 3 cracks and less than 60% LTE at the joints, the pavement is a candidate for DBR.

Table 6-1 Summary of project selection criteria

Pavement Condition	Action
Pavements exhibiting D-cracking, ASR, ACR distress <sup>1</sup> , or structurally inadequate pavement.	Do not do DBR
Average faulting < 0.10 in (2½ mm) and number of cracked panels ≤ 10% <sup>2</sup>	Do nothing
Average faulting ≥ 0.10 in (2½ mm) < 0.5 in (12.5 mm) and number of panels cracked ≤ 10% <sup>2</sup>	DBR
Average faulting ≥ 0.5 in (13 mm), number of panels cracked ≤ 10% & ADT ≤ 50,000 <sup>2</sup>	DBR
Average faulting ≥ 0.5 in (13 mm), number of panels cracked ≤ 10% & ADT ≥ 50,000 <sup>2</sup>	Lane reconstruction
More than 10 percent of panels show multiple cracks <sup>1</sup>	Lane reconstruction

Note: <sup>1</sup> Pierce et al 2003

<sup>2</sup> Caltrans, 2006b

### 6.3.2 Expected Performance

There is a significant body of experience with DBR projects. Georgia and Puerto Rico undertook DBR projects starting in the 1980's (FHWA, 1991 & Gulden and Brown, 1987). Washington State's first DBR project was complete in 1992 and that state has over 10 years of performance data for such projects (Pierce et al, 2003). California started DBR projects in the 1990's and a number of these projects have extensive performance data (Caltrans, 2001, 2002a, 2002b, and 2002c).

Data from many DBR projects clearly show a significant increase in LTE immediately after DBR. Joints and cracks typically had LTE's below 60% before DBR—some as low as 10%. After DBR, there is an increase in LTE, generally up to 70% to 90%. For example, for the Colfax test site in Northern California, LTE before DBR averaged 30%, while the average LTE over the same sections increased to 82% after DBR (Caltrans, 2002b).

DBR on existing pavements with good LTE do not extend pavement life since the grout and other repairs do not last as long as the original concrete.

According to at least one source (Gulden and Brown, 1987), the improvement in LTE after DBR appears to extend over a period of up to 15 years. Data from Washington State projects (Pierce et al, 2003) indicates LTE for retrofitted sections remains above 70% for some ten years after DBR. In addition to improved LTE, the magnitude of faulting is less in retrofitted sections than in similar, untreated sections. Thus there appears to be a significant improvement in LTE and a similar decrease in the development of faulting over at a 10 to 15 year period for properly execute DBR projects.

When properly installed, failure of DBR projects appears to be very low. A review of 7,000 dowel bars in Puerto Rico indicated that less than 0.5 percent failed (FHWA, 1991). A review of 13 DBR projects in 9 states indicated that only 2 percent of 515 properly installed dowel bars had failed (Gulden and Brown, 1987).

However, Caltrans has experienced a number of DBR projects that failed to meet performance expectations (Caltrans, 2001, 2002a, 2002c). Typical problems include: bond failure between concrete and backfill material; spalling at joints; and a rough surface after backfilling. In all of these cases, the main cause of performance problems appears to be poor workmanship during construction and/or insufficient time to complete the DBR project using good workmanship and still allow enough curing time for the backfill material.

The remaining sections of this chapter discuss how to properly design and execute a DBR project. Section 6.7 provides a troubleshooting guide based on lessons learned from both successful and unsuccessful DBR projects.

## 6.4 DESIGN AND MATERIAL CONSIDERATIONS

### 6.4.1 Load Transfer Devices

Although a number of load transfer devices have been tested, the most effective load transfer device and the one recommended by FHWA is the smooth, round dowel bars (FHWA/ACPA, 1997). Smooth dowel bars effectively transfer shear loads across joints and cracks but allow for the longitudinal movement of the bars within the concrete slab. This allows for thermal expansion and contraction of slabs at the joints.

### 6.4.2 Dowel Bar Specifications

A variety of dowel bars materials have been tested, including fiber reinforced plastic and stainless steel. Dowels should meet the following specifications.

**Material:** Caltrans (2006b) specifies the following requirements for dowel bars to be used on dowel bar retrofit projects. Dowel bars must be plain, smooth, round, epoxy-coated steel conforming to the requirements in ASTM Designation: A 615 / A 615M, Grade 40 or 60. Epoxy coating of dowel bars must conform to the provisions in ASTM Designation: A 884 / A 884M, Class A, Type 1 or Type 2, except that the bend test shall not be apply. Dowel bars must be free from burrs or other deformations detrimental to free movement of the bars in the concrete.

Dowels bars must be coated entirely with a bond breaker to allow longitudinal movement of bars after curing. Caltrans allows the following bond breaker materials (Caltrans, 2006b):

- Paraffin based lubricant shall be Dayton Superior DSC BB-Coat or Valvoline Tectyl 506 or an approved equal.
- White-pigmented curing compound in conformance with ASTM C 309, Type 2, Class A, and it shall contain 22% minimum nonvolatile compound consisting of at least 50% paraffin wax.

The compound shall be applied in 2 separate applications, with an application rate of approximately 1 gallon per 150 square feet (0.27 L/m<sup>2</sup>).

- Caltrans does not allow the use of oil- or asphalt-based bond breakers.

**Dimensions:** Caltrans (2005) requires the use of dowel bars with a length of 18 inches (~ 460 mm). Recent research by the Minnesota DOT indicates that 15 inch (380 mm) dowels provide adequate LTE. A 1½ inch (~ 40 mm) diameter dowel bar should be used when the existing pavement thickness is equal to or greater than 0.70 ft (215 mm). For a pavement thickness less than 0.70 ft (215 mm), use a 1¼ inch (~ 30 mm) diameter dowel bar.

**Expansion Caps:** Each end of the dowel bar must have a tight fitting, commercial quality, nonmetallic, non-organic material end cap that allows a minimum of ¼ inch (6 mm) of movement at each end of the bar (Caltrans, 2006b).

**Caulking Filler:** Caulking filler used for sealing the transverse joint at the bottom and sides of the dowel bar slot must be a silicone caulk containing a minimum of 50% silicone and designated as a concrete sealant. Caulking filler must conform to the requirements of ASTM Designation: C 834 (Caltrans, 2006b).

**Foam Core Inserts:** Each dowel bar must be fit with a foam core sheet that will be used to maintain the continuity of the joint or crack across the slot in which the dowel is placed. The foam core can be made of rigid styrofoam or closed cell foam material and faced with either poster board or a suitable plastic material. The insert shall be capable of remaining in a vertical position and tight to all edges during the placement of the fast setting grout (Caltrans, 2006b).

**Dowel Bar Support Chairs:** Dowel bars must be fit with chairs that will firmly hold the dowels centered in the slots during fast setting grout backfilling operations and support the dowels a minimum of ½ inch (13 mm) from the bottom of the slot while the grout backfilling is placed and consolidated. Caltrans allows the following dowel bar support chairs (Caltrans, 2006b):

- Completely epoxy-coated steel conforming to the requirements of ASTM Designation: A 884 / A 884M.
- Commercial quality nonmetallic, non-organic material.

Figure 6-2 shows a typical dowel bar used in a retrofit project, including the end caps, chair, and foam core insert.

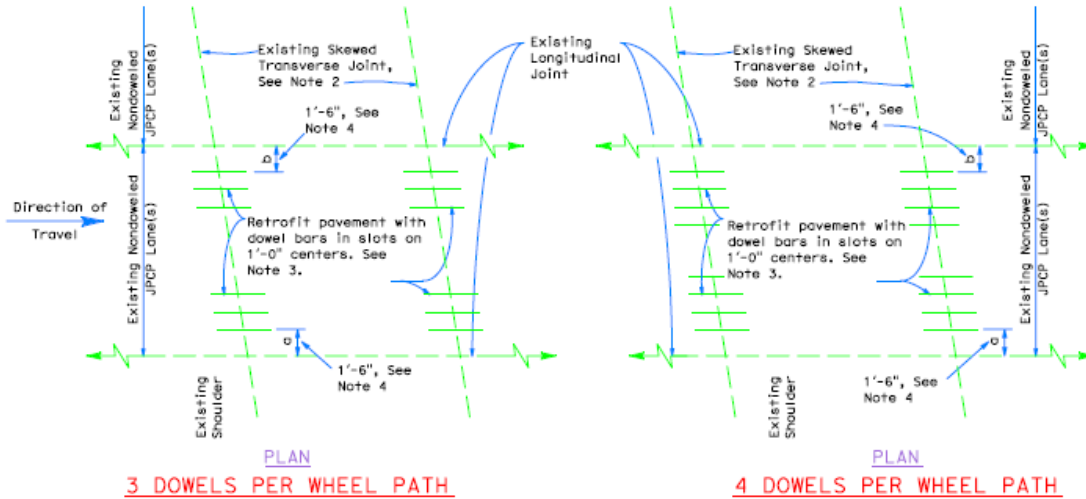

Figure 6-2 Photo of dowels with chair, end caps, and foam core inserts in place (Caltrans, 2006a)

### 6.4.3 Dowel Bar Layout

**Number of Dowels:** Early DBR projects installed 4 or 5 dowels in each wheelpath. However research indicates that 3 dowels per wheel path provides adequate LTE (Pierce et al, 2003).

**Dowel Location and Spacing:** Spacing between dowels should be 12 inches (300 mm). For pavements with asphalt concrete or untied PCC shoulders, the outer most dowels should be no more than 12 inches (300 mm) from the slab edge. Figure 6-3 shows the Caltrans recommended dowel layout (Caltrans, 2005).



**NOTES:**

1. See Project Plans for existing pavement thickness,  $D$ , and the lanes to be retrofitted.
2. The details shown on this plan for dowel bar retrofit also apply to existing concrete pavement constructed with transverse joints at right angles to longitudinal pavement joints.
3.  $\frac{3}{8}$ " diameter dowel bars 1'-6"  $\pm$   $\frac{1}{8}$ " in length are to be used when the existing pavement thickness,  $D$ , is equal to or greater than 0.70'. For a pavement thickness,  $D$ , less than 0.70', use  $\frac{1}{2}$ " diameter dowel bar 1'-6"  $\pm$   $\frac{1}{8}$ " in length.
4. Where the existing outer shoulder pavement is asphalt or concrete pavement without tie bars in the longitudinal joints of the retrofit lane, the 'a' dimension shall be 1'-0" and the 'b' dimension shall be 2'-0".
5. Seal existing transverse joint at bottom and sides of the dowel bar slot with caulking filler prior to placing dowel bar and foam core insert.
6. Thickness of foam core insert to match width of existing transverse joint.
7. The top of the foam core insert is to match the top of the existing pavement surface initially. The upper portion of insert will be removed during shaping of the sealant reservoir.
8. Plan only applicable when longitudinal joints coincide with lane line pavement delineation.

Figure 6-3 Dowel layout figure (Caltrans, 2005)

**Dowel Alignment and Tolerance:** The load transfer performance of DBR is highly dependant on the final orientation of the dowels at the end of construction. Dowels should be placed horizontally, with their axis aligned with the pavement edge or longitudinal joint and the center of the dowel at the slab's mid-depth. Caltrans specifies the following tolerances for dowel bar alignment (Caltrans, 2006b):

- The dowel bars must be placed to the depth shown on the plans, parallel to the traffic lane centerline and the top of the pavement surface, and the middle of the slot width within a tolerance of  $\frac{1}{4}$  inch (6 mm).
- Dowel bars must be centered at the transverse joint, such that no less than 8 inches (200 mm) and no more than 10 inches (250 mm) of the dowel bar are extended into each adjacent panel.

Other recommended tolerances for alignment by Pierce et al (2003) are:

- Vertical
  - Location: ± 0.5 inch (13 mm) of center of slab;
  - Skew from horizontal: ±0.5 inch (13 mm) over dowel bar length of 18 inches (460 mm)
  
- Longitudinal
  - Location: centered over joint ±0.5 inches (13 mm)
  - Embedment: 8 inches (200 mm) minimum on each end
  - Skew from parallel to pavement edge: ±0.5 inch (13 mm) over length of 18 inches (460 mm) dowel

#### 6.4.4 Backfill Material

**Material Selection:** Selection of backfill material is critical to achieving long-term performance of DBR. Materials used must provide workability to allow adequate consolidation of material around the dowel bars and provide the early strength needed to allow the repaired area to be opened to traffic reasonably soon after completion of DBR. Generally materials suitable for partial depth repairs work well for DBR backfill. Jerzak (1994) provides the following material properties for backfill material (Table 6-2).

Table 6-2 Recommended backfill material properties (Jerzak, 1994)

Property	Test Procedure	Recommended Value
<b>Neat Material</b>		
Compressive strength, 3 hr	ASTM C 109	Minimum 3050 psi (21 MPa)
Compressive strength, 24 hr	ASTM C 109	Minimum 4930 psi (34 MPa)
Abrasion loss, 24 hrs	California Test 550	Max loss 0.06 lbs (25 g)
Final Set Time		Minimum 25 minutes
Shrinkage, 4 days	ASTM C 596	Maximum 0.13 percent
Soluble Chlorides	California Test 422	0.05 max
Water Soluble Sulfates by mass, %	California Test 417	0.25 max
<b>Maximum Extended Material</b>		
Flexural Strength, 24 hr	California Test 551	Minimum 495 psi (3.4 MPa)
Bond to Dry PCC, 24 hr	California Test 551	Minimum 405 psi (2.8 MPa)
Bond to SSD PCC, 24 hr	California Test 551	Minimum 305 psi (2.1 MPa)
Absorption	California Test 551	Maximum 10 percent

In addition, the material should have a calculated durability factor of at least 90 percent after 300 freeze-thaw cycles per ASTM C 666.

These recommendations are consistent with current Caltrans specifications for DBR backfill material (Caltrans Specification 40-015\_A11-01-04). Caltrans DBR specifications allow backfill material to be (1) magnesium phosphate grout; (2) modified high alumina based grout; or (3) portland cement based grout.

Backfill material must reach a minimum compressive strength of 2000 psi (13.8 MPa) before opening the pavement to traffic (FHWA/ACPA, 1997). The current industry trend is to use portland cement based material rather than proprietary rapid set materials. While the rapid set materials have worked well in many cases, a number of quality control problems have been encountered with them in the field. Among other field considerations, the shrinkage issue appears paramount. Portland cement

based materials provide more working time and are generally less risky under actual field conditions. Below is a brief description of the materials that may be considered for dowel bar backfill:

**Portland cement concrete:** This material is readily available, less expensive than other materials, and does not create thermal compatibility issues. To achieve the early strengths needed to open a pavement relatively quickly, most mixes use Type III cement and an additional accelerator. This improves setting time and reduces shrinkage while still providing adequate working time. The backfill mixture is generally extended with sand and a coarse aggregate with a maximum size of 0.375 inches (9.5 mm). For pavements where traffic from studded tires or tire chains will occur, Washington State found it was important to include adequate coarse aggregates to prevent excessive surface wear (Pierce 2002).

**Proprietary rapid set materials:** Several proprietary materials such as Set 45 (magnesium phosphate-based), 5 Star Highway Patch, and AHT - DB Retrofit Mortar (Calcium aluminate-based) have also been used in DBR projects. The chief advantage of such materials is their quick setting time which can allow for an earlier opening of the repaired pavement. However, the same property limits for working time and can cause thermal compatibility problems. Material that has performed well in similar repairs may work well for DBR when used in accordance with manufacturer's recommendations.

**Polymer Concrete:** Polymer concrete has also been used successfully as a backfill material. Methacrylate-based materials such as Concessive, Silikal, and Crylon are common examples. These materials consist of a liquid resin, filler material, and fine aggregate. They can achieve as much as 80 percent of their full strength in 2 hours or less, thus allowing for rapid opening of pavement to traffic. Their chief drawbacks are cost and required workmanship in a very short period of time.

**Epoxy-Resin Materials:** Epoxy resin materials have been used in concrete patch repairs and may be suitable for DBR backfill material. Water-based fiber reinforced materials are available. They can be extended with pea gravel. They have the same early strength advantage of polymer concrete and the same cost and workmanship disadvantages. Epoxy-resin material must meet ASTM C 881 requirements and the manufacturer's guidance must be strictly followed by the contractor.

#### 6.4.5 Design of Slot-Dowel-Chair System

One of the most critical aspects affecting DBR performance is the final location of the dowel bars after placement of backfill material. The dowels must be placed precisely at the mid-depth of the slab, in a horizontal position, and along a line parallel to the edge or longitudinal joint of the pavement. Additionally dowels must be placed such that there is adequate space on all sides ( $\frac{1}{2}$  inch [13 mm]) to allow backfill material to flow around the dowels during backfilling.

In order to accomplish this, the slot, dowel, and chair must be designed as a complete system. The slot and chair shall be sized such that there is a snug fit when the dowel-chair system is placed in the slot. The chair shall be designed to rest on the saw kerfs at the edges of the slot rather than in the center of the slot where the concrete is rough due to the process of jack hammering out the concrete fin. The chair must be designed to provide adequate clearance between the base of the dowel and the base of the slot considering the raised area in the center of the slot where jack hammering fails to produce a perfectly flat surface (see Figure 6-4). The chair shall be designed to grip the dowel firmly such that the dowel is not dislodged from the chair during consolidation of the backfill material. Finally, the contractor shall be allowed sufficient time to complete as successful DBR project. The design and placement of the slot-dowel-chair system is critical to a successful DBR project.

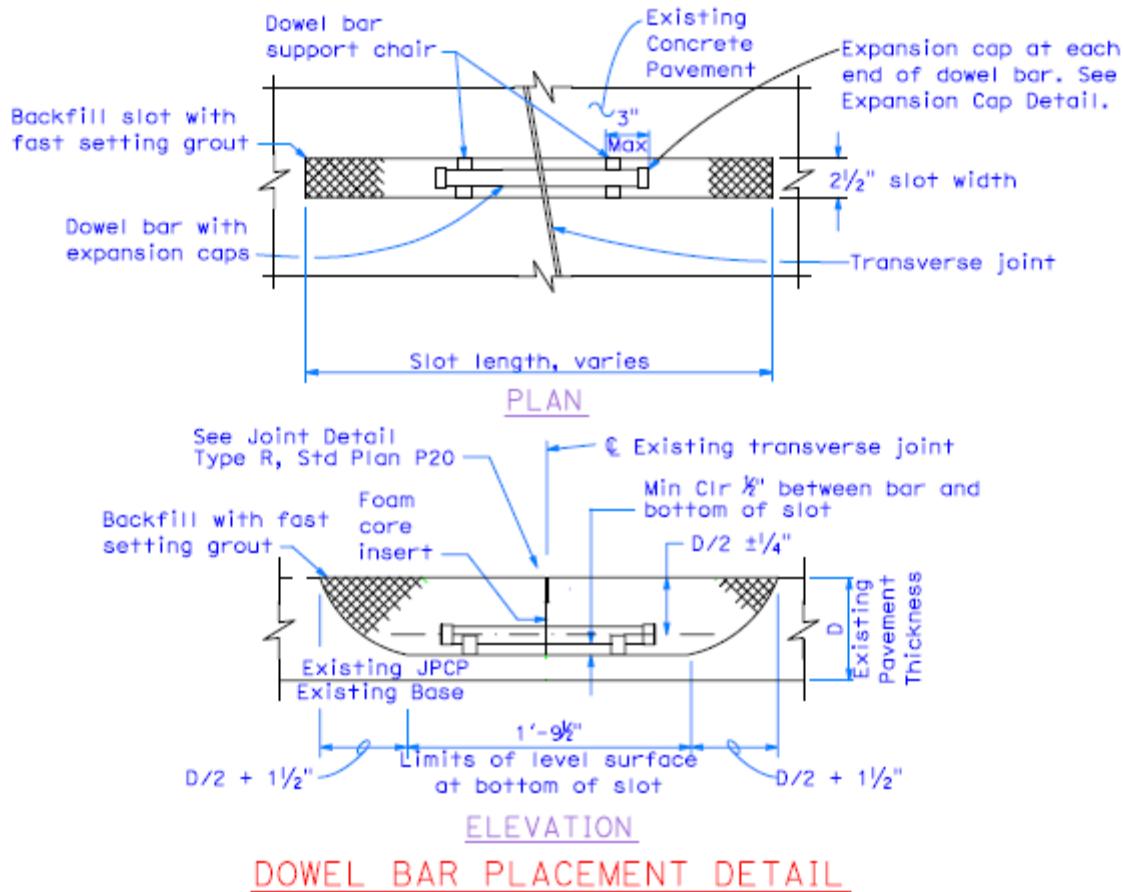

Figure 6-4 Dowel/Slot layout (Caltrans, 2005)

6.4.6 Typical Item Codes

Typical item codes for a dowel bar retrofit project are given in Table 6-3.

Table 6-3 Typical item codes for a dowel bar retrofit project

Item Code	Description
074017	Prepare water pollution control program
074019	Prepare storm water pollution prevention plan
074020	Water pollution control
074042	Temporary concrete washout (portable)
120090	Construction area signs
120100	Traffic control system
128650	Portable changeable message sign
406100	Dowel bar retrofit
413111	Repair spalled joints
414101	Seal transverse joint
420201	Grind existing concrete pavement

Note: Standard special provisions and PS&E Guide must be referred for a specific item code proposed for the project.

Caltrans Standard Materials and Supplemental Work Item Codes can be found at the following web site:

[http://i80.dot.ca.gov/hq/esc/oe/awards/#item\\_code](http://i80.dot.ca.gov/hq/esc/oe/awards/#item_code)

## 6.5 CONSTRUCTION PROCESS

### 6.5.1 Traffic Control and Safety

The traffic control plan for a dowel bar retrofit project shall be prepared in accordance with the Caltrans Safety Manual and the Caltrans Code of Safe Operating Practices. The signs and devices used must match the traffic control plan. The work zone must conform to Caltrans standard practice and the requirements set forth in the Caltrans Safety Manual and the Caltrans Code of Safe Operating Practices and any other pertinent requirements. Each worker must be fully equipped with the required safety equipment and clothing. Signage shall be removed in a timely fashion when it no longer applies.

Depending on project location, size, and amount of work, one of the following types of traffic control alternatives may be considered:

- Complete roadbed closure
- Continuous lane closure
- Weekend closure
- Nighttime closure

Details on traffic control may be found in the Caltrans Traffic Manual (Caltrans, 1996) or at the website: <http://www.dot.ca.gov/hq/traffops/signtech/signdel/trafficmanual.htm>.

### 6.5.2 Dowel Bar Retrofit Process

The DBR process contains the following steps:

- Cutting sides of slot
- Remove concrete from slot
- Sandblast and clean slot
- Seal joint or crack where it intersects the slot
- Place and align dowel bar
- Place backfill material
- Allow proper cure
- Diamond grinding (optional)
- Seal joint or crack

Figure 6-5 shows schematics of the construction process.



**STEP 1 - SAW SLOT FOR EACH DOWEL BAR.**

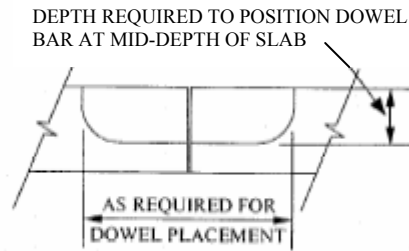

**STEP 2 - REMOVE CONCRETE TO FORM KERF AND RINSE WITH WATER.**

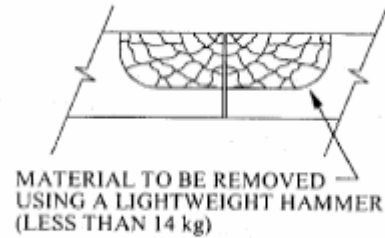

**STEP 3 - SANDBLAST AND VACUUM CLEAN SLOT.**

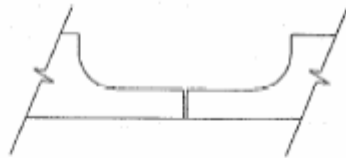

**STEP 4 - SEAL OR PRIME ALL THREE SIDES OF SLOT. TAPE OR SEAL CRACKS AND JOINTS.**

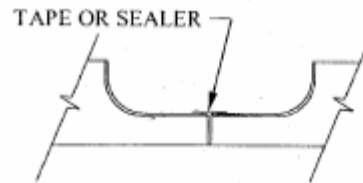

**STEP 5 - PLACE AND ALIGN DOWEL BARS AND JOINT FILLER MATERIAL**

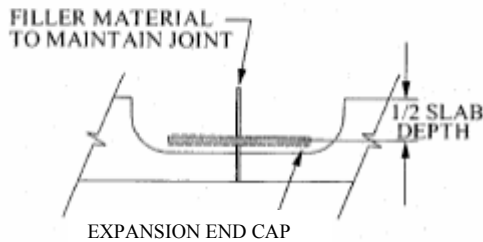

**STEP 6 - PLACE REPAIR MATERIAL**

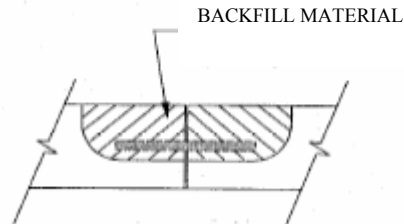

Figure 6-5 Schematics of the construction process (FHWA/ACPA, 1997)

**6.5.3 Cutting Sides of Slot**

Slot cutting should be done using a diamond saw slot cutter. Modified milling machines have been used on some project to cut the slots. However, this practice is not recommended because milling machines cannot cut slots within the required tolerances for accurate dowel bar placement and an additional concern that microcracking around the slot area often occurs.

Slot cutting machines where the blades are ganged together on a single arbor are essential to producing accurate slots that are parallel to the pavement edge or longitudinal joint. Ganged slot cutting machines are able to cut 6 to 8 slots simultaneously (covering 3 or 4 dowel bars per wheel path) are

currently available and commonly used (see Figure 6-6). To ensure that the slots are cut parallel to the pavement edge or longitudinal joint, it is essential that the slot cutting machine is carefully aligned with the pavement edge or longitudinal joint. This is true regardless of the orientation of the joint or crack. Figure 6-7 shows a set of well aligned slots cut for a three dowel bar / wheelpath installation.

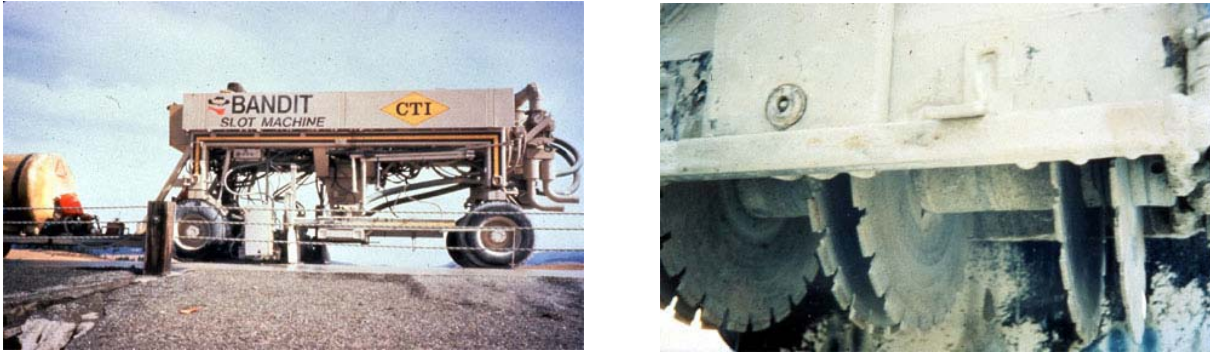

Figure 6-6 Slot cutting machine with close-up of ganged cutter heads (Caltrans, 2006a)

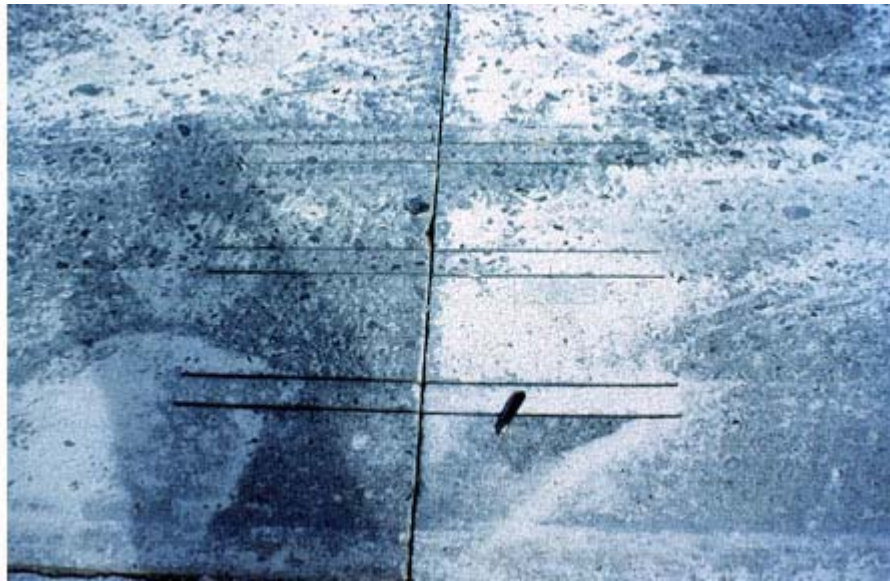

Figure 6-7 Three pairs of slots cut in a single pass by a ganged slot cutting machine (Caltrans, 2006a)

Slots must also be cut to a sufficient depth that the dowel will be centered at the mid-depth of the slab when the dowel-chair assembly is placed at the bottom of the slot. The width of the slot and the width of the chair must be carefully matched so that the dowel-chair assembly fits snugly into the slot, ensuring accurate alignment of the dowel within the slot. Slots are typically cut some 2½ inches (65 mm) wide. The slots must also be cut long enough so that a ½ inch (13 mm) clearance is maintained between the bottom of the dowel bar and the bottom of the slot along the entire length of the bar. It is important to consider the curvature of the saw blade when determining the actual required surface length for the slots (see Figure 6-8).

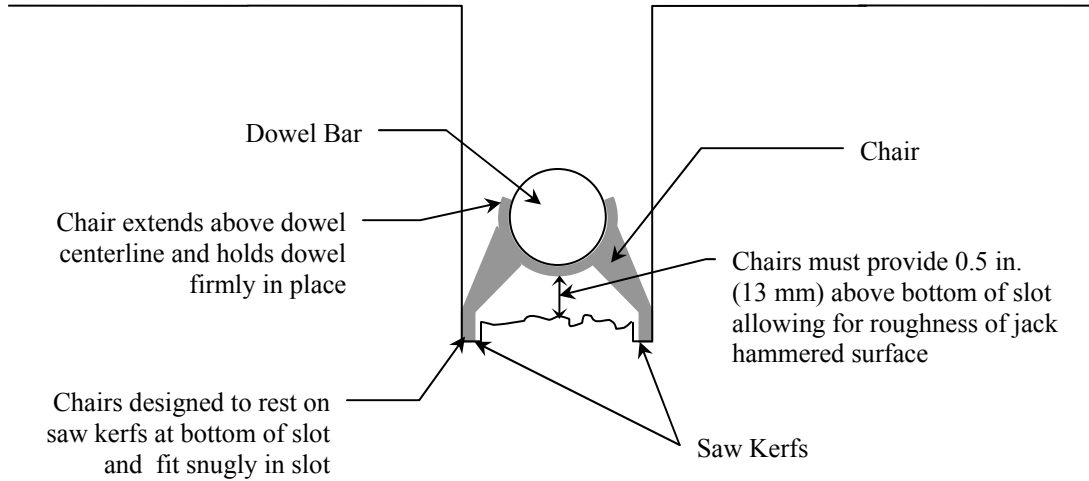

Figure 6-8 Details of chair-dowel system in slot

#### 6.5.4 Remove Concrete from Slot

Once the sides of the slot have been cut, the concrete fin remaining between the sides is removed. Care must be taken during this step not to damage the slot. The material surrounding the slot must not be cracked or damaged while removing the fin. For this reason, the fin material must be removed with a lightweight jackhammer (less than 30 lbs [14 kg]) and hand tools. Best results are achieved when the hammer is maintained at an angle of 45 degrees or shallower, especially when removing material from the bottom of the fin. This decreases the probability of the hammer punching through the bottom of the slot. Figure 6-9 shows jack hammering of the concrete fin.



Figure 6-9 Jack hammering (Caltrans, 2006a)

After removal of large pieces by jack hammering, the bottom of the slot must be flattened using a small toothed flat hammerhead. The bottom needs not to be perfectly smooth, but it must be flat enough that there is adequate clearance between the bottom of the dowel and the bottom of the slot.

After the fin material is removed and the bottom of the slot flattened, the slots must be thoroughly sandblasted. This process removes dust from saw cutting and hammering operations and provides a clean surface for backfill material to properly bond to. Finally, the slot is air blasted or vacuumed to remove any remaining loose material. Sandblasting and air blasting equipment must have oil/water traps to prevent contamination of the slot. High pressure water blasting has also been successfully used to clean slots. If water blasting is used, all standing and surface water must be removed from the slot before dowel placement. Figure 6-10 shows sandblasting of the slot.



Figure 6-10 Sandblasting (Caltrans, 2006a)

In addition to cleaning the slots, the pavement surface in the immediate vicinity of the slots should be clean and free of dirt and debris that might otherwise be blown or knocked into the prepared slot, thereby contaminating the otherwise well-prepared slot. It is important to keep the repair area extremely clean and dry. If debris or dust is present in the repair area, an additional cleaning is mandatory.

#### 6.5.5 Seal Joint or Crack

Any joint or crack that intersects the slot must be properly sealed. Sealing the crack or joint is necessary to prevent the backfill material from entering the joint. If backfill material enters the joint, this can result in spalling of the new joint. The entire length of the slot must be sealed: down both sides of the slot and at the bottom. Ensure that the caulking material completely seals the joint or crack but does not contaminate the sides or bottom of the slot itself. Figure 6-11 shows a properly sealed joint.





Figure 6-11 Sealing joint/crack (Caltrans, 2006a)

#### 6.5.6 Placing Dowel Bars

**Dowel bar preparation:** Inspect all dowel bars for damaged epoxy coating and reject any dowels with chipped or damaged epoxy. Dowels must be coated with a bond breaker. If a factory bond breaker is applied, ensure that the entire bar remains coated; re-treat as needed. Do not apply bond breaker anywhere near the slots. Any contamination of the slots with bond breaker will cause failure of the backfill material. A plastic cap should be placed on each end of the dowel bar in a manner allowing at least  $\frac{1}{4}$  inch (6 mm) of free space between the dowel end and outside of cap. The foam core insert and chairs should be placed on the dowels.

**Dowel bar placement:** Each prepared dowel bar must be centered horizontally in the slot and rest on the chairs in a horizontal position. If the slot has been properly sized and prepared, the dowel bar must be aligned vertically at the mid-depth of the slab and have a clearance of at least  $\frac{1}{2}$  inch (13 mm) between the bottom of the dowel bar and the bottom of the slot. If the dowel bar, chair, and slot have all been properly designed and constructed, the dowel-chair system should fit snugly within the slot and help restrain the dowel during backfilling operations.

**Dowel bar alignment:** The dowel bars must be placed within the slot such that they meet the tolerances specified in section 6.4.3. If the slot-dowel-chair system has been properly designed and the properly prepared, it should be a simple process of ensuring that the dowel-chair system is placed properly at the bottom of the slot. Attention must also be paid to the foam core insert to ensure that it is properly aligned with the joint or crack. Figure 6-12 shows placement of dowel bar in the slot.



Figure 6-12 Placing dowel-chair assembly (Caltrans, 2006a)

#### 6.5.7 Backfilling

Backfill material must be prepared and placed according to the manufacturer's recommendations. It must be prepared in small enough batches such that all of the material from a single batch can easily be placed before the material stiffens to the point that it is not workable. No additional water is allowed to be added to the material once the proper mixture has been prepared. If the material stiffens to the point that it cannot be properly placed, it should be discarded and a new batch must be prepared.

The vital elements to properly placing backfill material are: 1) place the material such that it does not disturb the dowel bar or the foam core insert, and 2) consolidate the material so it flows around the dowel and fills the entire slot including voids under and beside the dowel.

The backfill must not be "dumped" into the slots, as this provides the greatest likelihood of disturbing either the dowel bar or the foam core insert. Instead, the backfill must be placed on a clean area of pavement next to the slot and then carefully shoveled into the slot. The slot must be uniformly filled on both sides of the joint or crack in order to keep the foam core insert aligned with the joint or crack. Figure 6-13 shows the placement of backfill material.



Figure 6-13 Placing backfill (Caltrans, 2006a)

Backfill material must be consolidated with a small spud vibrator (less than one inch [25 mm] in diameter). Do not allow the vibrator to hit the dowel bar as that may cause the dowel to become misaligned. The backfill material must not be overworked as this can cause migration of fines and water to the surface of the backfill material and weaken it. Figure 6-14 shows the consolidation of backfill material.



Figure 6-14 Consolidating backfill (Caltrans, 2006a)

Backfill material must not be finished in a manner that tends to pull the material away from the sides of the slot. Instead, finishing operations must be done from the center of the slot toward the edges. If diamond grinding is to be done after the backfill material sets, the backfill should be finished 0.125 to 0.25 inches (3 to 6 mm) above the pavement surface. Immediately after finishing, the backfill material must be coated with curing compound or in accordance with the manufacturer's recommendations.

### 6.5.8 *Opening to Traffic*

The retrofitted pavement can be opened to traffic as soon as the backfill material has reached adequate strength—but not before! The minimum required compressive strength required to allow traffic on a repair is 2,000 psi (13.8 MPa) for slabs 8 in (200 mm) or thicker (FHWA/ACPA, 1997).

### 6.5.9 *Diamond Grinding*

Caltrans (2006b) specifies that retrofit pavement lanes must be ground, conforming to the smoothness and finishing provisions in Section 42, “Groove and Grind Pavement” of the Caltrans Standard Specifications and Special Provisions 40-015. Diamond grinding can significantly improve ride quality by eliminating existing faulting and elevations between the backfill material and the pavement as well as undulations or rough spots that result from DBR construction.

Diamond grinding should be completed within 30 days from the initial saw cutting for the dowel bar slots, since joint sealing cannot be completed until diamond grinding is done. Leaving the pavement with unsealed joints for an extended period of time is not advisable. All fast setting grout backfilled into the dowel slots shall have a minimum cure time of 12 hours before grinding (Caltrans, 2006b).

### 6.5.10 *Joint Sealing*

Transverse joints should be sealed as soon as possible after backfill material placement and diamond grinding. A low modulus silicone joint sealer should be used. Chapter 4 of this guide provides a detail description on the joint sealing.

### 6.5.11 *Job Review-Quality Control*

Ensuring a satisfactory DBR project requires a quality process throughout the project. The quality control process must start at the very beginning of project scoping and continue through project construction. The material presented below has been taken largely from an FHWA–NHI course material (FHWA/NHI, 2004).

## **Project, Document, and Plan Reviews**

Prior to start of the project, conditions at the proposed project site should be reviewed to ensure that the project still meets the criteria outlined in section 6.3. In particular, the project should be checked for structural or any additional deterioration that may make DBR an inappropriate treatment.

The following documents should be reviewed and any problems or required changes should be reconciled:

- Bid/project specifications and drawings
- Special provisions
- Traffic control plan
- Manufacturer’s installation instructions for backfill material(s)
- Material safety data sheets (MSDS)
- Agency application requirements

Plan review includes a review of the slot-dowel-chair system. This review should also check the proposed slot cutting equipment, dowel bar, and chair design to ensure that the system allows accurate placement of dowel bars in accordance with project specifications (see section 6.4.5).



## Preconstruction Reviews

Material Review—the following material related items should be checked:

- Proposed backfill material
  - meets specifications
  - comes from an approved and qualified source
  - has been sampled and tested
  - packaging is not damaged (leaking, torn, or pierced)
- Caulking filler meets specifications
- Dowel bars, chairs, foam core inserts, and end caps meet specifications
- Curing compound meets specifications
- Joint sealant material meets specifications
- Logistics planning will ensure a supply of sufficient quantities of materials when needed

Equipment—prior to the start of the construction, all equipment should be inspected including:

- Slot saw—sufficient size and horse power to simultaneously cut all required slots in one wheel path
- Jackhammers—lightweight, less than 30 lbs (14 kg), which have proper heads for both fin removal and smoothing of the slot bottom
- Sand blasters—adjusted for correct sand rate; contains moisture and oil traps
- Air compressors—sufficient volume and pressure to remove all debris and dust from slots
- Auger type mixing equipment—free from material buildup and properly sized
- Volumetric mixing equipment: Calibrated and in good condition (CT 109 certified)
- Miscellaneous testing equipment—slump cone, air meter, cylinder molds w/lids, rod, mallet, ruler, and 10 ft (3 m ) straightedge, available and functional
- Vibrators—correct size (1 inch [25 mm] in diameter or less) and operating correctly

Weather requirements: Ensure that the weather conditions at the time of construction are within acceptable limits. The following conditions are recommended:

- Air and surface temperature suitable for concrete placement (typically above 40° F [4° C])
- Review manufacturer's climate requirements for backfill material and placement
- Do not remove existing concrete from slot if rain is predicted

Traffic Control: All traffic control devices should comply with Federal Manual on Uniform Traffic Control Devices and the California Supplement to the FMUTCD. Verify that devices in-place correspond to requirements of the approved traffic control plan.

## Construction Inspection

**Slot cutting:** The following areas should be inspected during slot cutting:

- Slot cutter is lined up parallel to pavement edge or longitudinal joint before start of cutting operations
- Slots are parallel to each other and the pavement edge or longitudinal joint
- Correct number of slots are cut
- Slot alignment is adjusted to miss any existing longitudinal cracks

- Slot length, width, and depth are as specified in design (See section 6.4.5)

**Concrete Fin Removal:** During concrete fin removal, the inspector should ensure that the proper size jackhammer is being used; jack hammering is done at an angle to the pavement, not normal to the pavements surface, and care is taken not to punch through base of pavement. After the fin materials are removed, the inspector should ensure that the base of slot is smoothed with a light hammer and flat toothed, flat hammerhead.

**Slot Preparation:** The following items should be inspected during slot cleaning and preparation:

- Slots should be carefully sandblasted on all slot surfaces and the cut surfaces inspected with scraper or other device to ensure that all slurry residue has been removed. Also ensure that no oils are introduced into the slot during sandblasting.
- Air blasting after sandblasting should remove all loose material from slot. If slots are left open for a significant period of time, a second air blasting will be required before placing backfill material. A visual inspection is needed to determine if a second air blasting is necessary.
- All debris including broken concrete, slurry material, and dirt must be cleared from an area within 3 to 4 feet (1.0 to 1.2 m) of slots. This will aid in preventing recontamination of slots after cleaning.
- Existing joints or cracks must be sealed with an approved sealant along the entire length of the project. Sealant should not more than ½ inch (13 mm) beyond the joint or crack along the sides or base of the slot.

**Dowel Bar Placement:** The following items should be inspected during dowel bar placement:

- Dowel bars are undamaged and epoxy coating is intact with no chips or abrasions.
- Dowel bars are completely coated with bond breaker before placing into chairs. If factory bond breaker has been used, it should be clearly visible. If not, the bars must be recoated. Ensure that the bond breaker is not placed on bars in the vicinity of slots so as to prevent contamination of slots with bond breaker.
- End caps are placed on each end with at least a ¼ inch (6 mm) gap between end of bar and top of cap.
- Chairs are securely fastened to the bars.
- Dowel-chair assembly fits securely into slot and is placed squarely on base of slot with chair legs resting at bottom of saw kerfs. There should be a ½ inch (13 mm) gap between bottom of the dowel and bottom of the slot.
- Dowel bars should be centered across the joint or crack and the foam core insert should be aligned with the joint or crack.
- Dowel bars should be placed within the tolerances specified in section 6.4.2.

**Backfill Mixing and Placement:** Proper mixing and placement of backfill material is critical to DBR performance. Attention to detail at this stage is very important. The following items should be inspected during backfill mixing and placement:

- Ensure approved backfill material is being used and mixed according to manufacturer's guidance.
- No additional water is added to mixture at anytime.
- Batches are small and sized such that all material can be properly placed and consolidated before setting or hydrating.

- All slot surfaces are clean and dry.
- Backfill is consolidated with a properly sized vibrator. The vibrator should not touch the dowel bar and the material should not be over consolidated. It should require only 2 to 4 quick insertions of the vibrator into the material to properly consolidate it.
- Backfill material is finished with an outward motion ensuring material remains in contact with slot sides. Material should be finished 0.125 to 0.25 in. (3 to 6 mm) above pavement surface.
- Approved curing compound is applied to backfill material immediately after finishing or cured in accordance with the manufacturer’s recommendations.

**Cleanup:** After completion of DBR, all loose concrete is removed and disposed of according to project specifications. Any loose debris should also be removed. All mixing equipment should be cleaned up before the backfill material sets.

## 6.6 PROJECT CHECKLIST AND TROUBLESHOOTING GUIDE

### 6.6.1 Factors to Consider

For a successful DBR project, slots must be properly cut in the pavement, dowel bars placed in proper alignment with adequate clearance on sides and bottom, and backfill material placed and properly consolidated without disturbing the dowel bars. Most DBR problems can be traced to one of two root causes: 1) poorly designed slot-dowel-chair system and/or 2) poor workmanship or quality control during construction.

The importance of quality construction practices cannot be underestimated. It is essential that the contractors who are responsible for QC be familiar with the DBR process and knowledgeable of common problems and ways to avoid these problems.

### 6.6.2 Project Checklist

The following checklist was primarily based on guidelines from the FHWA Pavement Preservation Checklist Series: [http://www.fhwa.dot.gov/pavement/pub\\_details.cfm?id=351](http://www.fhwa.dot.gov/pavement/pub_details.cfm?id=351) and the FHWA Course: Pavement Preservation Design and Construction of Quality Preventive Maintenance Treatments.

<b>Preliminary Responsibilities</b>	
<b>Project Review</b>	<ul style="list-style-type: none"> <li>✓ Verify that pavement conditions have not significantly changed since the project was designed.</li> <li>✓ Verify that the pavement is structurally sound. Evidence of pumping (i.e., surface staining or isolated wetness) and faulting exceeding 1/8 in. (3 mm) are indicators of lack of proper subgrade support possibly necessitating undersealing.</li> <li>✓ Check estimated quantities for dowel-bar retrofit.</li> </ul>
<b>Document Review</b>	<ul style="list-style-type: none"> <li>✓ Bid/project specifications and drawings</li> <li>✓ Special provisions</li> <li>✓ Traffic control plan</li> <li>✓ Agency application requirements</li> <li>✓ Material safety data sheets</li> <li>✓ Manufacturers’ installation instructions for backfill materials</li> </ul>

<b>Materials Checks</b>	
<b>Cementing grout</b>	<ul style="list-style-type: none"> <li>✓ Verify that dowel slot backfill material meets specification requirements.</li> <li>✓ Verify that dowel slot backfill material is being obtained from an approved source as required by the specification.</li> <li>✓ Verify that the component materials for the dowel slot backfill have been sampled, tested, and approved prior to installation as required by contract documents.</li> </ul>
<b>Dowel bars</b>	<ul style="list-style-type: none"> <li>✓ Verify that dowels, dowel bar chairs, and end caps meet specification requirements.</li> <li>✓ Verify that dowel bars are properly coated with epoxy (or other approved material) and free of any minor surface damage in accordance with contract documents.</li> </ul>
<b>Joint/crack materials</b>	<ul style="list-style-type: none"> <li>✓ Verify that joint/crack re-former material (compressible insert) meets specification requirements (typically polystyrene foam board, 1/2 in. [12 mm] thick).</li> <li>✓ Verify that joint sealant material meets specification requirements.</li> </ul>
<b>Other materials</b>	<ul style="list-style-type: none"> <li>✓ Verify that additional or extender aggregates have been properly produced, with acceptable quality.</li> <li>✓ Verify that material packaging is not damaged so as to prevent proper use (packages leaking, torn, or pierced).</li> <li>✓ Verify that caulking filler meets specification requirements.</li> <li>✓ Verify that curing compound when required meets specification requirements.</li> </ul>
<b>General</b>	<ul style="list-style-type: none"> <li>✓ Verify that all required materials are on hand in sufficient quantities to complete the project.</li> <li>✓ Ensure that all material certifications required by contract documents have been provided to the agency prior to construction.</li> </ul>
<b>Equipment Inspections</b>	
<b>Slot Cutting Equipment</b>	<ul style="list-style-type: none"> <li>✓ Verify that slot sawing machine is of sufficient weight, horsepower, and configuration to cut the specified number of slots per wheelpath to the depth shown on the plans.</li> <li>✓ Verify that removal jackhammers are limited to a maximum rated weight of 30 lb (14 kg).</li> </ul>
<b>Slot Cleaning and Preparation</b>	<ul style="list-style-type: none"> <li>✓ Verify that sand blaster unit is adjusted for correct sand rate and that it is equipped with and using oil and moisture filters/traps.</li> <li>✓ Verify that air compressors have sufficient pressure and volume to adequately remove all dust and debris from slots and meet agency requirements.</li> </ul>
<b>Mixing and Testing Equipment</b>	<ul style="list-style-type: none"> <li>✓ For auger-type mixing equipment, ensure that auger flights or paddles are kept free of material buildup, which can cause inefficient mixing operations.</li> <li>✓ Ensure that volumetric mixing equipment, such as mobile mixers, is kept in good condition and is calibrated (CT 109) on a regular basis to properly proportion mixes.</li> <li>✓ Ensure that material test equipment required by the specifications are all available on site and in proper working condition (typically including slump cone, pressure-type air meter, cylinder molds and lids, rod, mallet, ruler, and 10 ft (3 m) straightedge).</li> </ul>
<b>Other Equipment</b>	<ul style="list-style-type: none"> <li>✓ Verify that vibrators are the size specified in the contract documents (typically 1 in. [25 mm] in diameter or less) and are operating correctly.</li> <li>✓ Verify that the concrete testing technician meets the requirements of the contract document for training/certification.</li> <li>✓ Ensure that sufficient storage area is available on the project site specifically designated for the storage of concrete cylinders.</li> </ul>

<b>Others</b>	
<b>Weather Requirements</b>	<ul style="list-style-type: none"> <li>✓ Review manufacturer installation instructions for requirements specific to the backfill material used.</li> <li>✓ Air and surface temperature meet agency requirements (typically 40 °F [4 °C] and rising) for concrete placement.</li> <li>✓ Dowel bar installation should not proceed if rain is imminent.</li> </ul>
<b>Traffic Control</b>	<ul style="list-style-type: none"> <li>✓ Verify that the signs and devices used match the traffic control plan presented in the contract documents.</li> <li>✓ Verify that the setup complies with the Federal Manual on Uniform Traffic Control Devices or local agency procedures.</li> <li>✓ Verify that flaggers are trained and qualified according to contract documents and agency requirements.</li> <li>✓ Verify that unsafe conditions, if any, are reported to a supervisor.</li> <li>✓ Ensure that traffic is not opened to the repaired pavement until the backfill material has attained the specified strength or curing time as required by the contract documents.</li> <li>✓ Verify that signs are removed or covered when they are no longer needed.</li> </ul>
<b>Project Inspection Responsibilities</b>	
<b>Slot Cutting and Removal</b>	<ul style="list-style-type: none"> <li>✓ Verify that all slots are cut parallel to each other and to the centerline of the roadway within the maximum tolerance permitted by the contract documents, typically 1/4 in. (6 mm) per 12 in. (300 mm) of dowel bar length.</li> <li>✓ Verify that the number of slots per wheelpath is in agreement with contract documents (typically three or four).</li> <li>✓ Verify that the cut slot length extends the proper distance each side of the construction joint as required by the contract documents. This is especially important for joints and cracks that are skewed.</li> <li>✓ Verify that concrete fins between the saw cuts are removed using 30 lb (14 kg) maximum weight jackhammers.</li> <li>✓ Verify that the bottoms of slots are smoothed and leveled using lightweight bush hammer.</li> </ul>
<b>Slot Cleaning and Preparation</b>	<ul style="list-style-type: none"> <li>✓ Verify that after concrete removal, slots are prepared by sandblasting, ensuring that all saw slurry is removed from the slot.</li> <li>✓ Verify that air blasting is utilized to clean slots. A second air blasting may be required immediately before placement of dowel slot cementing grout if slots are left open for a duration exceeding that permitted in the contract documents.</li> <li>✓ Verify that the existing joint/crack is sealed with approved caulking filler along the bottom and sides of slot to prevent concrete patch material from entering the joint/crack.</li> </ul>
<b>Placement of Dowel Bars</b>	<ul style="list-style-type: none"> <li>✓ Verify that plastic end caps are placed on each end of the dowel bar to account for pavement expansion as required by the contract documents.</li> <li>✓ Verify that dowels have been coated with lubricant to prevent bonding of concrete patch material to dowels in accordance with contract documents.</li> <li>✓ Verify that proper clearance is maintained between the supported dowel bar and the sidewalls, ends, and bottom of the cut slot in accordance with contract documents.</li> <li>✓ Schematic diagrams are intended for reference purposes only and are not intended to supersede contract documents.</li> <li>✓ Verify that chairs are used to align the dowel correctly in the slot and support it, and permit dowel slot backfill material to completely encapsulate the dowel bar.</li> <li>✓ Verify that joint re-former material (foam core insert) is placed at the mid-point of each bar and in line with the joint/crack to allow for expansion and to re-form the joint/crack.</li> </ul>

	<ul style="list-style-type: none"> <li>✓ Verify that dowel bars are centered across the joint/crack such that the minimum embedment of the dowel bar on each side of the joint is in accordance with contract documents.</li> </ul>
<b>Mixing, Placing, Finishing, and Curing Backfill Material</b>	<ul style="list-style-type: none"> <li>✓ Verify that quantities of concrete patch material being mixed are small enough to prevent premature set.</li> <li>✓ Verify that material is consolidated using small, hand-held vibrators that do not touch the dowel bar assembly during consolidation.</li> <li>✓ Verify that concrete patch material is finished flush with surrounding concrete, using an outward motion to prevent pulling material away from patch boundaries. The surface of the concrete patch material should be finished slightly “humped” if diamond grinding will be done.</li> <li>✓ Verify that adequate curing compound is applied immediately following finishing and texturing in accordance with contract documents and manufacturer’s recommendations.</li> </ul>
<b>Cleanup</b>	<ul style="list-style-type: none"> <li>✓ Remove all concrete pieces and loose debris from the pavement surface.</li> <li>✓ Dispose of old concrete in accordance with contract documents.</li> <li>✓ Properly clean mixing, placement, and finishing equipment for the next use.</li> </ul>
<b>Diamond Grinding</b>	<ul style="list-style-type: none"> <li>✓ Diamond grinding of the pavement surface should be completed within 30 days of placement of the concrete patch material.</li> </ul>
<b>Resealing Joints and Cracks</b>	<ul style="list-style-type: none"> <li>✓ Verify that joints are resealed after diamond grinding in accordance with contract documents.</li> </ul>

### 6.6.3 Troubleshooting Guide

The following guide provides a summary of possible problems, typical causes and potential solutions. The guide was primarily based on guidelines from the FHWA Pavement Preservation Checklist Series ([http://www.fhwa.dot.gov/pavement/pub\\_details.cfm?id=351](http://www.fhwa.dot.gov/pavement/pub_details.cfm?id=351)) and the FHWA Course: Pavement Preservation Design and Construction of Quality Preventive Maintenance Treatments.

Problem	Causes and solutions
Slots are not parallel to pavement edge or longitudinal joint	Cause: <ul style="list-style-type: none"> <li>• Slot cutting machine not properly aligned.</li> </ul> Solutions: <ul style="list-style-type: none"> <li>• If concrete fins have not been removed, fill saw cuts with epoxy resin</li> <li>• If fins have been removed, fill slots with approved backfill material</li> <li>• Properly align slot cutting machine and cut new slots at different location (still in the wheel path)</li> </ul>
Dowel bar slots are too shallow	Cause: <ul style="list-style-type: none"> <li>• Improper slot cutting procedure</li> </ul> Solution: <ul style="list-style-type: none"> <li>• Recut slots to proper depth and remove additional fin material</li> </ul>
Dowel bar slots are too deep	Causes: <ul style="list-style-type: none"> <li>• Improper slot cutting technique</li> <li>• Improper jackhammer technique</li> <li>• Jackhammer too heavy</li> </ul> Solutions: <ul style="list-style-type: none"> <li>• Identify source of problem and correct procedures for future work</li> <li>• At current location fill existing slots with approved backfill material, relocate and recut slots to proper depth (still in the wheel path)</li> </ul>
Concrete fin not easily removed	Cause: <ul style="list-style-type: none"> <li>• Check for mesh reinforcement</li> </ul>

Problem	Causes and solutions
	Solution: <ul style="list-style-type: none"> <li>• If reinforcement is present, cut reinforcement at each end before attempting to remove fin</li> </ul>
Jackhammer punches through bottom of slot	Causes: <ul style="list-style-type: none"> <li>• Improper jackhammer technique</li> <li>• Jackhammer too heavy</li> <li>• Severely deteriorated JPCP</li> </ul> Solutions: <ul style="list-style-type: none"> <li>• Make full depth repair across entire lane at affected joint/crack</li> <li>• Identify root cause and correct procedures if needed</li> </ul>
Epoxy coating on dowel bar is chipped or missing	Causes: <ul style="list-style-type: none"> <li>• Mishandling of dowel bars in field</li> <li>• Improper application of epoxy at factory</li> </ul> Solutions: <ul style="list-style-type: none"> <li>• Discard dowel bars and use an undamaged replacement</li> <li>• Determine root cause and either correct field practices or factory practices as required</li> </ul>
Joint/crack sealant does not fully seal joint/crack along entire length expose in slot	Cause: <ul style="list-style-type: none"> <li>• Improper sealant installation</li> </ul> Solution: <ul style="list-style-type: none"> <li>• Reapply sealant before placement of backfill material</li> </ul>
Joint/crack sealant extends more than 0.5 in. (13 mm) into slot	Cause: <ul style="list-style-type: none"> <li>• Improper sealant installation</li> </ul> Solution: <ul style="list-style-type: none"> <li>• Remove excess sealant and reapply to joint/crack if needed</li> </ul>
Backfill material cracks in place	Causes: <ul style="list-style-type: none"> <li>• Patch opened to traffic too soon</li> <li>• Dowels not properly aligned</li> <li>• Backfill material extruded into slot</li> <li>• Backfill material too stiff incompatible with existing concrete</li> </ul> Solutions: <ul style="list-style-type: none"> <li>• Identify root cause.</li> <li>• If slot is not damage and is properly aligned, backfill can be removed and new dowel and backfill placed</li> <li>• If slot is misaligned or damaged, remove existing backfill and replace without new dowel bar</li> </ul>
Backfill material pops out of slot	Causes: <ul style="list-style-type: none"> <li>• Slot not properly cleaned or prepared</li> <li>• Shrinkage during curing</li> </ul> Solutions: <ul style="list-style-type: none"> <li>• Identify root cause and correct construction procedure</li> <li>• If slot is not damage, backfill can be removed and new dowel and backfill placed</li> </ul>
Backfill material wears faster than adjacent pavement	Cause: <ul style="list-style-type: none"> <li>• Backfill material mix not properly designed or material not properly mixed</li> </ul> Solutions:



Problem	Causes and solutions
	<ul style="list-style-type: none"> <li>• Determine root cause and adjust construction procedures</li> <li>• Depending on severity of wear, area may be filled with epoxy resin</li> </ul>

## 6.7 KEY REFERENCES

American Concrete Pavement Association (ACPA), Specification Guideline for Dowel Bar Retrofit (IS104P), 2002.

Caltrans, 2001, *Dowel Bar Retrofit Evaluation: District 12, Orange County, Interstate 5*, October 2001. <http://www.dot.ca.gov/hq/esc/Translab/pubs/CPC2001/D12I-405.pdf>

Caltrans, 2002a, *Slab Replacement and Dowel Bar Retrofit: District 11, San Diego County, Route 08*, January 2002. [http://www.dot.ca.gov/hq/esc/Translab/pubs/D11\\_Route8.pdf](http://www.dot.ca.gov/hq/esc/Translab/pubs/D11_Route8.pdf)

Caltrans, 2002b, *Evaluating Load Transfer Restoration: District 1, Mendocino County, Route 101 – North Bound; District 3 Placer County, Route 80 – West Bound*, July 2002. <http://www.dot.ca.gov/hq/esc/Translab/pubs/Colfax.pdf>

Caltrans, 2002c, *Dowel Bar Retrofit Evaluation: District 12, Orange County, Interstate 405*, September 2002. [http://www.dot.ca.gov/hq/esc/Translab/pubs/D12\\_I405.pdf](http://www.dot.ca.gov/hq/esc/Translab/pubs/D12_I405.pdf)

Caltrans, 2005. *Standard Plan P7*, Sacramento, CA, September 2005.

Caltrans, 2006a, *Pavement Tech Notes: Concrete Pavement Preservation, Dowel Bar Retrofitting Guidelines*, September 2006. <http://www.dot.ca.gov/hq/oppd/pavement/guidance/dowel-bar-guidelines.pdf>

Caltrans, 2006b. *Standard Special Provision 40-015\_MR A 5-1-06 Concrete Pavement (Retrofit Dowels)*. [http://www.dot.ca.gov/hq/esc/oe/specifications/SSPs/2006-SSPs/Sec\\_10/22-42/40-015\\_E\\_A05-01-06.doc](http://www.dot.ca.gov/hq/esc/oe/specifications/SSPs/2006-SSPs/Sec_10/22-42/40-015_E_A05-01-06.doc)

Federal Highway Administration (FHWA) / American Concrete Pavement Association (ACPA), 1997, *Concrete Pavement Rehabilitation: Guide to Load Transfer Restoration*, FHWA-SA-97-103, ACPA JP001P, 1997.

Federal Highway Administration (FHWA), 1991, *Design Review Report on Retrofit Dowels*, Puerto Rico Division, 1991.

Federal Highway Administration (FHWA), 1996, *Pavement Notebook*, FHWA-PD-96-037, Washington, DC, 1996.

Federal Highway Administration (FHWA), 2004, *Pavement Preservation Design and Construction of Quality Preventive Maintenance Treatments*, NHI course 131103, Washington, DC, Nov 2004.

Federal Highway Administration (FHWA), 2005, *Pavement Preservation Checklist Series #8: Dowel-Bar Retrofit for Portland Cement Concrete Pavements*, Washington, DC, 2005.  
<http://www.fhwa.dot.gov/pavement/preservation/ppcl00.cfm>

Gulden, W. and Brown, D., 1987, *Improving Load Transfer in Existing Jointed Concrete Pavements*, FHWA Report No. FHWA/RD-82/154, 1987.

Jerzak, H., 1994, *Rapid Set Materials for Repairs to Portland Cement Concrete Pavement and Structures*, Caltrans, 1994.

Pierce, L., et al, 2003, *Ten-Year Performance of Dowel Bar Retrofit-Application, Performance & Lessons Learned*, TRB Annual Meeting, Washington, DC, 2003.

Rufino, D., Mallela, J., and Darter, M., 2005, *Dowel Bar and Slab Size Recommendations Based on Mechanistic-Empirical Pavement Design Guide, Proceedings*, 8th Intl Conf on Concrete Pavements, Colorado Springs, CO 2005.

*Disclaimer*

*The contents of this guide reflect the views of the authors who are responsible for the facts and accuracy of the data presented herein. The contents do not necessarily reflect the official views or policies of the State of California or the Federal Highway Administration. This guide does not constitute a standard, specification, or regulation.*

## **CHAPTER 7 ISOLATED PARTIAL DEPTH CONCRETE REPAIR**

This chapter provides an overview of isolated partial depth concrete repairs. It presents a description of the effectiveness and limitations of this technique, as well as material selection, design considerations, and construction procedures. Also included are a troubleshooting guide and a list of important factors to be considered during design and construction of this treatment.

### **7.1 PURPOSE AND DESCRIPTION OF TREATMENT**

Partial depth repairs are preventive maintenance techniques that restore structural integrity and rideability of the pavement, and deter further deterioration, thus extending the pavements service life. Also, partial depth repairs are required to prepare an existing, distressed pavement prior to a structural overlay or restoration project.

#### *7.1.1 Partial Depth Repair*

Partial depth repair restores localized surface distresses, which do not extend beyond the upper one-third of a concrete pavement. It involves the removal of small, unsound areas of concrete and their replacement with suitable repair materials. Partial depth repair is commonly used to repair low severity spalling but can also be used for small areas with scaling problems. Table 7-1 illustrates the distress types and severity levels where partial depth repairs should be applied.

Table 7-1 Distresses addressed by partial depth repairs for jointed concrete pavements

Distress Type	Severity Levels that Require Partial-Depth Repair
Spalling of joints	< 6 inches from the joint and < 2 inches in depth
Scaling of joints	Low
Deterioration adjacent to existing repair	Low
Deterioration of existing repairs	Low

Spalls caused by material problems, such as D-cracking, Alkali-Silica Reactivity (ASR), or by lockup or corrosion of dowel bars at transverse joints cannot be addressed by partial depth repairs. Such spalls usually indicate deterioration beyond the upper one-third of the pavement; therefore in these instances a full depth repair would be more appropriate (see Chapter 8).

### **7.2 MATERIALS AND SPECIFICATIONS**

A wide variety of materials are available for partial depth repairs. The selection of an adequate material will depend on the project's environmental, design, and funding requirements. Repair

materials include conventional portland cement concrete mixtures, special cements, proprietary materials, and bituminous materials. These repair materials will be described in more detail in sections 7.2.2 and 7.2.3.

### 7.2.1 *Materials Selection*

Repair materials are selected based on available curing time, climatic conditions, material costs, equipment requirements, mixing and placing time, desired service life, and the size and depth of the repair(s). Material properties, such as strength gain, modulus of elasticity, bond strength, scaling resistance, sulfate resistance, abrasion resistance, shrinkage characteristics, coefficient of thermal expansion, and freeze-thaw durability should also be included in the selection process.

Repair materials must be compatible in strength and volume stability with the existing pavement. An adequate bonding between the repair material and the existing slab is critical to obtain an integral slab.

Despite higher costs, special cements and proprietary materials are generally used for partial depth repairs. A good rule of thumb for selecting the material for PCC slab repair is to use the most convenient material that meets the lane closure requirements (Caltrans, 2004).

### 7.2.2 *Cementitious Materials*

#### **Normal Concrete Mixtures**

Portland cement type I, II, or III is typically used for partial depth repairs. Nationally, Type I has been widely used for pavement repairs because of its relatively low cost, availability, and ease of use. Although the rate of strength gain under cool weather may be too slow to allow a timely opening to traffic, insulated layers can be used to reduce the curing time (FHWA, 2001). However, Caltrans most often uses Rapid Strength Concrete (RSC) for partial depth repairs. Some properties of normal concrete mixtures are described in Table 7-2.

FHWA (2001) recommends that the size of the coarse aggregate used must not be larger than one-half the minimum repair thickness. The mix should be a low slump mixture of air entrained concrete having a water-cement ration not exceeding 0.44 (FHWA, 2001).

Caltrans allows the following cementitious materials (Caltrans Standard Specifications Section 90), unless otherwise specified:

- “Type IP (MS) Modified” cement;
- Combination of “Type II Modified” portland cement and mineral admixtures;
- Combination of Type V portland cement and mineral admixtures;
- Type III portland cement shall be used only as allowed in the special provisions or with the approval of the Engineer.

Table 7-2 Properties of normal concrete mixtures used as partial depth repair materials (Patel, Mojab, and Romine, 1993)

Category	Working time	Installation temperature	Time to open traffic	Moisture condition of	
				repair surface	aggregate
Normal concrete mixtures	15-30 min.	40° - 110°F (4° - 43°C)	4-72 hours	SSD to dry	1-3% to dry
High early strength PCC mixtures	15-30 min.	32° - 110°F (0° - 43°C)	4-6 hours	SSD to dry	1-3% to dry

- SSD = saturated surface dry; dry = oven dry

### Specialty Cement Mixtures

These mixtures contain some kind of cement in place of or in addition to normal Type I, Type II, or Type III cement; this may be hydraulic cement, gypsum-based cement, magnesium phosphate cement, or high-alumina cement, as described below:

- **Gypsum-based cement mixtures** contain calcium sulfates which accelerate strength gain and may be used in temperatures above freezing and all the way up to 110 °F (43 °C). They are not recommended for placement in rainy and freezing weather (NCHRP, 1977), and may promote steel corrosion in reinforced pavements (Good-Mojab, Patel, and Romine, 1993).
- **Magnesium phosphate cement mixtures** are characterized by a high early strength, low permeability, and good bonding to clean dry surfaces. However, this concrete is extremely sensitive to water content and aggregate type (especially limestone); significant strength reduction can be obtained with very small amounts of excess water (Good-Mojab, Patel, and Romine, 1993).
- **High alumina cement mixtures** produces a rapid strength gain concrete with good bonding properties (to dry surfaces) and very low shrinkage. However, they should not be used because a significant strength loss is likely to occur due to chemical conversions in the calcium aluminate cement during curing (ACPA, 1998).
- **Accelerating admixtures/additives** are sometimes used to achieve high early strengths and reduce the time to opening. Premature deterioration can be developed due to insufficient curing time. Calcium chloride (CaCl<sub>2</sub>) accelerators are not allowed by Caltrans due to detrimental factors such as excessive shrinkage and corrosion of load transfer devices.
- **Alumina powder** has been used as an admixture with Type I, Type II, or Type III cement mixtures to counteract shrinkage. However, the reactivity of aluminum powder can be difficult to control in field proportioning, particularly in small batch operations. The use of alumina powder may also decrease the bond strength and patch abrasion resistance.
- **Other rapid setting materials** are also available that may perform adequately. However, some rapid hardening repair materials are affected by high alkaline bearing materials. These materials may react with certain siliceous aggregates to form alkali-silica reactivity (ASR). Therefore, it is important to make sure that no chemical incompatibilities exist between the patch material and the aggregates used in the mixture.

Some properties of specialty cement mixtures are described in Table 7-3.

Table 7-3 Properties of specialty cement mixtures used as partial depth repair materials (Patel, Mojab, and Romine, 1993)

Category	Working time	Installation temperature	Time to open traffic	Moisture condition of	
				repair surface	aggregate
Gypsum-based cement mixtures	15-30 min.	32° - 110°F (0° - 45°C)	1-2 hours	SSD to dry	1-3% to dry
Magnesium phosphate cement mixtures	5-45 min.	32° - 90°F (0° - 30°C)	1-2 hours	Dry	1-3% to dry

- SSD = saturated surface dry; dry = oven dry

### 7.2.3 Specialty Materials

The application of specialty materials should closely follow the manufacturer’s recommendations. The manufacturer’s guidelines concerning repair area preparation, bonding, placement, curing, and opening time should also be followed to ensure adequate performance of these repair materials.

#### Polymer Concretes

Polymer concretes are characterized by their quick set in comparison to normal concretes. They are both more expensive and quite sensitive to certain field conditions, such as temperature range. Polymer concretes are a combination of polymer resin, aggregate, and a set initiator. They are categorized by the type of resin used: epoxies, methacrylates, polyester-styrenes, and urethanes.

#### Epoxy

Epoxy mixtures provide a repair material with excellent adhesive properties and low permeability. However, they are not thermally compatible with normal concrete, sometimes resulting in early repair failure. The use of larger aggregate can improve their thermal compatibility with concrete and reduce the risk of debonding.

Epoxies are available with a wide variety of setting times, placement temperature ranges, strengths, bonding capabilities, and abrasion resistance properties. The selection of a particular epoxy mixture should be based on the project’s environmental conditions and construction constraints.

Epoxy concrete should not be used to repair spalls caused by reinforced steel because it can accelerate the corrosion of the steel in the adjacent, unrepaired concrete by creating a strongly cathodic area (Furr, 1984).

#### Methyl Methacrylate Concrete

Methyl methacrylate concretes have relatively long working times (30-60 minutes), high compressive strengths, good adhesion to clean dry concrete, and a wide placement temperature range between 40 and 130 °F (5 - 55 °C). A major concern with methacrylates is that many of them produce fumes, which are a health hazard and can ignite if exposed to a spark or flame.

#### Polyester-Styrene Concrete

Polyester-styrene concrete has very similar properties to methyl methacrylate concrete, but possesses a much slower rate of strength gain. This limits its usefulness for partial-depth repairs.

### Polyurethane Concrete

Polyurethane concrete consists of a two-part polyurethane resin mixed with aggregate. They set very quickly (~ 90 seconds). Two types are available: the older type which is moisture sensitive and will foam in contact with water; and the newer ones which claim to be moisture tolerant and can be placed on wet surfaces.

Some properties of specialty materials are described in Table 7-4.

Table 7-4 Properties of specialty materials used in partial depth repairs (Patel, Mojab, and Romine, 1993)

Category	Working time	Installation temperature	Time to open traffic	Moisture condition of	
				repair surface	aggregate
Epoxy concretes	5-15 min.	40° - 90°F (5° - 30°C)	1-3 hours	Dry	Dry
Methyl methacrylate concretes	30-60 min.	40° - 130°F (5° - 55°C)	1-2 hours	Dry	Dry
Polyurethane concrete	1 min.	> 0°F (> -20°C)	10-20 min.	Dry	Dry

- SSD = saturated surface dry; dry = oven dry

#### 7.2.4 Bituminous Materials

Bituminous materials are not recommended for permanent repairs of rigid pavements because they allow excessive horizontal movement of the slab, provide no load transfer across the joint, and may lead to rapid deterioration. They should be only considered as a short-term or temporary repair.

#### 7.2.5 Bonding Agents

A bonding agent is required on partial depth repairs to enhance the bond between the existing concrete and the repair material. Sand-cement grouts and epoxy agents have been widely used on these types of repairs.

- Sand-cement grouts – These grouts have performed adequately when the repairs are protected from traffic for 24 to 72 hours. The recommended mixture for the sand-cement grout consists of one part sand and one part cement by volume, with sufficient water to produce a mortar with a thick, creamy consistency (FHWA, 2001).
- Epoxy bonding agents – These bonding agents have proven adequate when repair closure time needs to be reduced to 6 hours or less. They have been used with both PCC and proprietary repair materials.

Caltrans allows the use of the following fast-setting grout material (Caltrans, 2007a):

1. Either of the following magnesium phosphate grouts:
  - Single component water activated
  - Dual component with a prepackaged liquid activator
2. Modified high alumina based grout
3. Hydraulic cement based grout



Caltrans additionally allows the use of polyester grout, consisting of a polyester resin binder and dry aggregate. The resin is an unsaturated isophthalic polyester-styrene copolymer. Additional material requirements are specified in Caltrans SSP No. 41-151.

### 7.3 ENGINEERING CONSIDERATIONS

Partial depth repairs performance can be highly improved through proper design. This section provides important design considerations for partial depth repairs, such as project selection, concurrent work considerations, and repair locations and boundaries.

#### 7.3.1 Project Selection

Partial depth repairs should be used on localized surface distresses, such as low severity spalling or scaling. Deterioration must be within the upper one-third of a concrete pavement slab. Partial depth repairs are not appropriate for moderately severe spalls that generally extend more than 6-10 inches (150-250 mm) from the joint. Such spalls typically indicate further damage which needs to be addressed with a full depth slab repair.

Cracks extending through the full thickness of the slab or spalls with exposed reinforcing steel or load transfer devices cannot be corrected with a partial depth repair. A full depth repair should be used in these cases.

#### 7.3.2 Concurrent Work

For partial depth repairs, when done as part of a comprehensive pavement restoration project, the sequence of repairs is very important. Slab stabilization should be done before partial depth repairs to include any accidental spalling that can occur during slab stabilization. Partial depth repairs should be done before or concurrently with full depth repairs. Diamond grinding should follow partial and full depth repairs, followed by joint resealing as needed.

#### 7.3.3 Repair Locations and Boundaries

A visual survey is needed to identify and mark distressed areas. Engineering judgment, coring, deflection studies, and sounding techniques (such as striking the concrete surface with a hammer or steel rod, or by dragging a chain) should be used to define the extent of the deterioration beneath the surface and determine partial-depth repair boundaries.

Repair boundaries for partial depth repairs must extend 2 to 6 inches (50 to 150 mm) beyond the delaminated or spalled area. Table 7-5 provides the minimum dimensions of repair areas for partial depth repairs (Wilson, Smith, and Romine, 1999b).

Table 7-5 Minimum dimensions of repair area for partial depth repairs

Location of Spalling	Minimum Dimensions of Repair Area		
	Depth	Length	Width
At one joint	2 in (50 mm)	10 in (250 mm) or length of spalled area + 4 in (100 mm) whichever is greater	4 in (100 mm) or width of spalled area + 2 in (50 mm) whichever is greater
At two joints	2 in (50 mm)	8 in (200 mm) or length of spalled area + 2 in (50 mm) whichever is greater	4 in (100 mm) or width of spalled area + 2 in (50 mm) whichever is greater
Away from joints	2 in (50 mm)	10 in (250 mm) or length of spalled area + 4 in (100 mm) whichever is greater	5.5 in (140 mm) or width of spalled area + 4 in (100 mm) whichever is greater

### 7.3.4 Typical Item Codes

Typical Caltrans item codes for an isolated partial depth concrete repair project are given in Table 7-6.

Table 7-6 Typical item codes for an isolated partial depth concrete repair project

Item Code	Description
120090	Construction area signs
120100	Traffic control system
128650	Portable changeable message sign
150846	Remove concrete pavement
150306	Repair spalled concrete
156515	Repair spalled and unsound surface area
401108	Replace concrete pavement (rapid strength concrete)
413101	Repair corner breaks
413111	Repair spalled joint
413114	Replace joint seal (existing concrete pavement)
413115	Seal joint (existing concrete pavement)
420201	Grind existing concrete pavement
511040	Concrete surface finish
511055	Concrete surface texture
515028	Repair spalled surface area

*Note: Standard special provision and PS&E must be referred for specific item codes proposed for the project.*

Caltrans Standard Materials and Supplemental Work Item Codes can be found at the following web site:

[http://i80.dot.ca.gov/hq/esc/oe/awards/#item\\_code](http://i80.dot.ca.gov/hq/esc/oe/awards/#item_code)

Associated specifications for repairing spalled joints are:

- SSP No. 40-150. Repair Spalled Joints
- SSP No. 41-151. Repair Spalled Joints (Polyester Grout)

## 7.4 CONSTRUCTION PROCESS

### 7.4.1 Traffic Control and Safety

Traffic control is required both for the safety of the traveling public and construction personnel. Traffic control must be enforced before equipment or personnel enter the work zone. Caltrans project specifications and the Caltrans Code of Safe Operating Practice should be followed. Traffic is not allowed on repair areas until the curing period and the joint sealing process are completed.

Depending on the project location, size, and amount of repair work, one of the following types of traffic control alternatives may be considered:

- Complete roadbed closure
- Continuous lane closure
- Weekend closure
- Nighttime closure

### 7.4.2 Equipment

Equipment requirements vary according to the treatment method and the material selected, and they will be described in more detail in Sections 7.4.3 through 7.4.11. Equipment may be required for:

- Sawing and material removal
- Cleaning
- Repair material placement
- Finishing
- Curing
- Joint sealing

### 7.4.3 Repair Locations

As mentioned in section 7.3.3, the difficult task of defining the location and boundaries of repairs must be performed by experienced personnel through a thorough field survey. This field survey should be complemented with coring, sounding techniques, and FWD load-deflection studies to define the extent of deterioration beneath the surface and determine repair boundaries. This survey should be performed as close as possible to the proposed repair work and should include additional distressed areas that have developed since the previous pavement inspection. Distressed areas should be examined and repair boundaries identified and marked on the pavement surface (see Figure 7-1).



Figure 7-1 Marking damage area for removal (FHWA, 2006)

#### 7.4.4 Concrete Sawing and Removal

Five different methods have been used nationally to remove deteriorated concrete for partial depth repairs:

- **Saw and patch**—The saw and patch method employs diamond-bladed saws to define the repair area and light jackhammers to chip out the damaged concrete. The vertical faces and square corners will prevent spalling of the repair material along the perimeter. The saw cut must be at least 2 inches (50 mm) deep. Light jackhammers should be used to chip out the damaged concrete until sound and clean concrete is exposed. Jackhammers heavier than 30 lb. (13 kg) should not be used because of the risk of damage to the underlying, sound pavement.

Material removal should begin near the center of the repair area and proceed towards (but not up to) the edges. Jackhammers and mechanical chipping tools should be operated at an angle of about 45° to minimize damage to sound concrete. Spade bits are preferable to gouge bits for improved chipping control and less damage to underlying, sound concrete. Material removal near the edges should be performed with lighter equipment (10-20 lb [4.5-9.0 kg]).

- **Chip and patch**—This procedure differs from the saw and patch procedure in that the repair boundaries are not sawed. Light, 15 lb. (7 kg) jackhammers remove the damaged concrete, starting near the center and proceeding towards the edges. The chisel points should always point towards the inside of the patch area. Light jackhammers and hand tools should be used to remove the material near the edges of the patch area.

Even though chipping and patching is quicker and provides a rougher vertical face in comparison with the saw and patch procedure, it is generally not recommended. Some disadvantages of this procedure include thin and feathered patch edges which are prone to spalling and debonding, more damage to sound concrete, and the difficulty of achieving vertical sides.

- **Mill and patch.** Carbide-tipped milling machines have been used efficiently and economically on projects requiring the removal of large repair areas. The milling procedure leaves rounded edges that may be made vertical by sawing or jack hammering.

Adequate supervision is required to avoid spalling on adjacent pavement edges by the milling equipment. The bottom surface and repair edges should be checked to ensure that all of the unsound concrete is removed during the milling procedure.

- **Water blast and patch.** A high pressure (15,000 - 30,000 psi [100,000 - 200,000 kPa]) water jet is used to remove damaged concrete. Skilled personnel should set the pressure of the equipment to remove deteriorated concrete only. The jet should reduce most of the damaged concrete to a fine slurry, thus minimizing hauling costs. The resulting slurry and debris must be removed immediately, before the slurry sets.

Shields should be installed to protect traffic from the high pressure jets. The resulting rough and irregular surface promotes good mechanical interlock between the repair material and the existing slab.

- **Clean and patch.** The clean and patch procedure consists of the removing deteriorated or loose concrete with hand tools and light jackhammers. Loosened material is then removed with a stiff broom before repair material placement. This procedure should only be used for emergency repairs under adverse environmental conditions.

Caltrans requires the outlines of rectangular areas to be cut with a diamond bladed saw to a minimum depth of 2 inches (50 mm); and to 1½ inches (35 mm) for the polyester grout but not greater than one-third of the pavement depth. Unsound and damaged concrete between the saw cut and the joint, and to the depth of the saw cut, shall be removed by methods that will not damage the concrete pavement that is to remain in place. A pneumatic hammer greater than 15 pounds (7 kg) shall not be used for removal of concrete (Caltrans, 2007a and 2007b). Figures 7-2 and 7-3 illustrate part of this process.



Figure 7-2 Concrete removal using the saw and patch methodology (FHWA, 2006)



Figure 7-3 Concrete removal using the mill and patch methodology (FHWA, 2006)

#### 7.4.5 Cleaning and Repair Area Preparation

The repair surface must be thoroughly clean before the application of repair material. A clean surface will enhance bonding between the repair material and the existing concrete. The use of abrasive blasting, such as sandblasting, is highly recommended (see Figure 7-4). High-pressure water blasting is another alternative which is very useful in urban environments where dust control is enforced. The water blasting equipment for concrete cleaning shall be capable of producing a blast pressure of 2,900 to 5,800 psi (20 to 40 MPa) (Caltrans, 2007a and 2007b).



Figure 7-4 Cleaning the repair area with sandblasting equipment (FHWA, 2006)

Air blasting shall be used to remove all residues from abrasive blasting (Caltrans, 2007a and 2007b). Air blasting equipment must be checked for moisture and oil contamination because of their potential to impede or reduce bonding between the repair material and the existing concrete.

### 7.4.6 Joint Preparation

Adequate joint preparation is essential to the performance of partial depth repairs. Repairs located next to transverse joints and cracks require sufficient space to minimize the development of compression forces due to thermal expansion of the slabs. Also, a repair material that infiltrates the crack or joint can restrict slab movement and cause the development of compressive stresses at lower depths that will deteriorate the repair. This type of deterioration can also occur along longitudinal joints or at lane-shoulder joints.

Partial depth repair failures can be reduced by placing a bond breaker between the repair material and the adjoining slab (see Figure 7-5). Some examples of widely used compressible materials are polystyrene, polyethylene, and asphalt-impregnated fiberboard. Caltrans specifies that the joint bond breaker shall extend one inch beyond the edges of the patch (Caltrans, 2007a and 2007b). FHWA recommends that the bond breaker extends 1 inch (25 mm) below and 3 inches (75 mm) beyond the repair boundaries (FHWA, 2001).

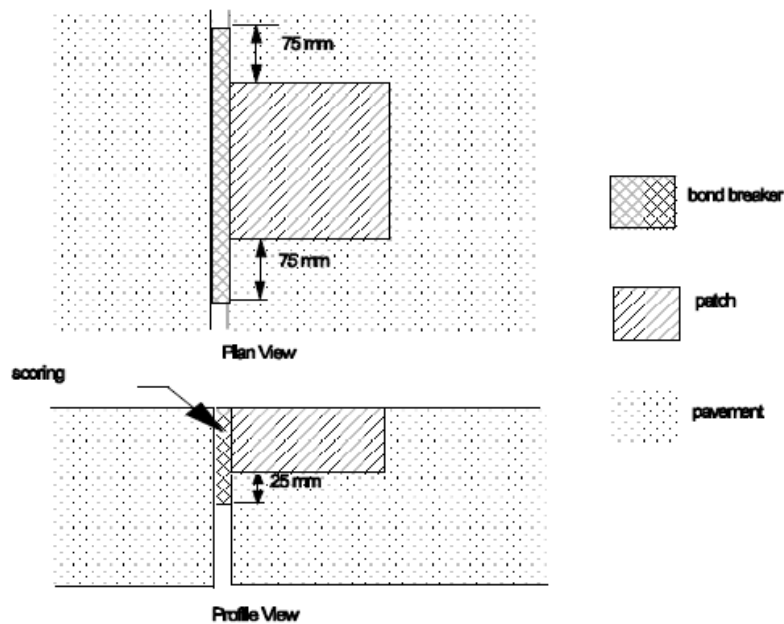

Figure 7-5 Placement of bond breaker at joint (FHWA, 1999)

Once the patch has cured, the insert should be removed and a preformed joint reservoir is ready for joint sealing. A more complete description of joint sealing can be found in section 7.4.10.

Partial depth repairs next to asphalt shoulders can result in damage to the repair or the shoulder, due to the flow of repair material into the asphalt shoulder. The repair material, once hardened, may restrict longitudinal movement and result in deterioration. For these cases, the following procedure is recommended:

- Remove a thin section of the asphalt shoulder along the whole length of the repair.
- Place a wood board or other kind of insert at this location (lane/shoulder joint) to provide confinement during the placement and hardening of the repair material. No flow of repair material is allowed into the shoulder.
- After the curing period, remove the insert and patch the shoulder with asphalt material.

#### 7.4.7 *Materials Placement*

##### **Clean Surface**

Before placing the bonding agent and the repair material, make sure the repair area is clean and dry. If debris or dust is present in the repair area, air blow the patch area again.

##### **Bonding Agent**

It is recommended to apply a thin, even coat of bonding agent over the entire patch area including the side walls. Scrubbing the bonding agent into the patch area with a stiff bristle brush will improve material bonding. The cementitious grout must not be allowed to dry before the placement of the repair material. If the grout is allowed to set, it must be removed by a water jet or sandblasting, and then fresh grout should be reapplied before placement of the repair material. If epoxy or proprietary bonding agents are used, follow the manufacturer's instructions for their proportioning, mixing, and application.

##### **Placement**

Careful control of mixing times and water content is very important because of the quick setting nature of repair materials. Do not allow the addition of extra water to the concrete mix to achieve better workability because of the resulting reduction in concrete strength and increased shrinkage potential.

Repair materials should be placed under favorable environmental conditions. Portland cement concrete and most proprietary repair materials should not be installed under adverse conditions, such as air or pavement temperatures below 40° F (4° C) or in wet substrates. Placement when temperatures are below 55 °F (13 °C) will required the use of warm water, insulation covers, and longer curing periods.

High frequency internal vibrators with small heads are usually used for partial depth repairs. The vibrator should be held at a slight angle (15-30°) from the vertical, but do not use it to move material from one place to another as this may result in segregation. For very small repairs, hand tools may be used. Cutting with a trowel is recommended over rodding or tamping.

During placement, a slight over-filling of the repair area should be allowed to allow for volume reduction during consolidation. It is also important to ensure that the concrete is well vibrated over the entire repair area, especially around the edges of the repair, and to avoid over-finishing the repair area.

#### 7.4.8 *Finishing*

A critical aspect of partial depth concrete slab repairs is to obtain a level finish of the repair area with the surrounding pavement. To provide adequate skid resistance and a smooth transition, the surface of the repair should be textured to match that of the existing pavement.

In partial depth repairs, due to their small dimensions, a stiff board can usually be used to screed the repair area. The repair material should be worked towards the perimeter of the repair area, which will enhance bonding to the existing concrete. Finally, a hand trowel can be used to remove minor irregularities.

#### 7.4.9 *Curing*

Adequate attention to curing will reduce the development of shrinkage cracking and promote more complete hydration by preventing moisture loss from the concrete. Proper curing is even more



important when accelerating admixtures are used. Curing procedures shall be in conformance with Caltrans Standard Specifications Section 90-7, “Curing Concrete.”

In hot weather (e.g. greater than 100 °F or 40 °C), the use of pigmented curing compounds is highly recommended over other curing procedures (moist burlap and polyethylene). Caltrans recommends a nominal rate of application of 150 ft<sup>2</sup>/gal (4 m<sup>2</sup>/L), unless otherwise specified (Caltrans Standard Specifications Section 90-7). ACPA recommends an application rate of about 200 ft<sup>2</sup>/gal (5 m<sup>2</sup>/L). Insulation mats are not necessary in hot weather, and if used can result in concrete cracking (ACPA, 1989).

In cold weather (e.g. less than 50 °F), the use of insulating blankets and tarps can be used to accelerate hydration and promote higher early strengths, thus allowing for earlier opening to traffic. Special care is required during the removal of insulation blankets because rapid cooling of the pavement surface can cause cracking. When large temperature differences (>30 °F) exist between concrete and air temperatures, insulation blankets should not be removed from the repair area.

Curing time and procedures for epoxy and proprietary materials should follow the manufacturer’s recommendations.

#### *7.4.10 Joint Sealing*

Joint sealing will reduce future spalling and minimize water infiltration. Both longitudinal and transverse repair joints should be sealed. The joints should be sawed or formed, sandblasted, air blasted, and a backer rod should be inserted and joint sealant applied. More detail information on joint sealing can be found in chapter 4.

#### *7.4.11 Opening to Traffic*

Repair material must have gained sufficient strength before it is opened to traffic. A compressive strength of 3,000 psi (21 MPa) is generally specified by most agencies before the repair area is opened to traffic. Caltrans requires a minimum flexural strength of 405 psi (2.8 MPa), as determined in accordance with CTM 523 for slab replacement (Caltrans, 2004). It is preferable to have a measure of the actual concrete strength before allowing the repair to be opened to traffic, especially if very early opening is required (e.g. 4 hrs or less curing time). On such projects, maturity meters or pulse-velocity devices may be used to monitor concrete strength (ACPA, 1995).

#### *7.4.12 Job Review-Quality Issues*

Quality control and workmanship are critical to the performance and life of partial depth repairs. There must be a cooperative effort between Caltrans and the contractor’s representatives to conduct inspections of all construction procedures, materials, and project equipment before and during the partial depth repair project. Project inspections will allow earlier detection and correction of deficiencies in workmanship, equipment and materials, thus resulting in improved performance.

Improper construction and placement techniques, followed by material deficiencies, have been the most frequent quality issues related to poor performance of partial depth repairs. Frequent causes of failure include improper preparation of the repair areas, insufficient consolidation, and improper use of repair materials, as well as incompatibility in thermal expansion between the repair material and the original slab.

## 7.5 PROJECT CHECKLIST AND TROUBLESHOOTING GUIDE

The project checklist and troubleshooting guide, included in this section, provide important information which can help solve difficulties and improve performance in partial depth concrete slab repairs. The project checklist describes important aspects, such as preliminary responsibilities, material and equipment requirements, project inspection responsibilities, and cleanup responsibilities, all of which should be duly considered in order to promote a successful project. The troubleshooting guide describes common problems encountered during construction and their solutions.

### 7.5.1 Project Checklist

The following checklists are primarily based on guidelines from the FHWA Pavement Preservation Checklist Series ([http://www.fhwa.dot.gov/pavement/pub\\_details.cfm?id=351](http://www.fhwa.dot.gov/pavement/pub_details.cfm?id=351)) and the FHWA / NHI Course entitled “Pavement Preservation Design and Construction of Quality Preventive Maintenance Treatments”.

<b>Preliminary Responsibilities</b>	
<b>Document Review</b>	<ul style="list-style-type: none"> <li>✓ Bid/project specifications and drawings</li> <li>✓ Special provisions</li> <li>✓ Agency application requirements</li> <li>✓ Traffic control plan</li> <li>✓ Manufacturers’ installation instructions, recommendations</li> <li>✓ Material safety data sheets</li> </ul>
<b>Project Review</b>	<ul style="list-style-type: none"> <li>✓ Verify that pavement conditions have not significantly changed since the project was designed and that partial-depth repair is appropriate for the pavement.</li> <li>✓ Verify that the estimated number of partial depth repairs agrees with the number specified in the contract.</li> <li>✓ Agree on quantities to be placed, but allow flexibility if additional deterioration is found below the surface.</li> <li>✓ Note that some partial-depth repairs may become full-depth repairs if deterioration extends below the top third of the slab.</li> </ul>
<b>Materials Checks</b>	
<b>Concrete patch material</b>	<ul style="list-style-type: none"> <li>✓ Verify that patch material is of the correct type and meets specifications.</li> <li>✓ Verify that patch material is obtained from an approved source or as required by the contract documents.</li> <li>✓ Verify that patch material has been sampled and tested prior to installation as required by the contract documents.</li> <li>✓ Verify that additional or extender aggregates have been properly produced and meet requirements of contract documents.</li> </ul>
<b>Other materials</b>	<ul style="list-style-type: none"> <li>✓ Verify that material packaging is not damaged so as to prevent proper use (for example, packages are not leaking, torn, or pierced).</li> <li>✓ Verify that bonding agent (if required) meets specifications.</li> <li>✓ Verify that curing compound (if required) meets specifications.</li> </ul>
<b>Joint Sealing</b>	<ul style="list-style-type: none"> <li>✓ Verify that joint/crack re-forming material (compressible insert) meets specifications (typically polystyrene foam board, 1/2 in. [12 mm] thick).</li> <li>✓ Verify that joint-sealant material meets specifications.</li> </ul>
<b>General</b>	<ul style="list-style-type: none"> <li>✓ Verify that sufficient quantities of materials are on hand for completion of the project.</li> </ul>

<b>Equipment Inspections</b>	
<b>Concrete Removal Equipment</b>	<ul style="list-style-type: none"> <li>✓ Verify that concrete saws are of sufficient weight and horsepower to adequately cut the existing concrete pavement to the depth required along the patch boundaries as required by the contract documents.</li> <li>✓ Verify that concrete saws and blades are in good working order.</li> <li>✓ Verify that the maximum rated weight of removal jackhammers is 31 lb (14 kg).</li> </ul>
<b>Patch Area Cleaning Equipment</b>	<ul style="list-style-type: none"> <li>✓ Verify that the sand-blaster unit is adjusted for correct sand rate and that it is equipped with and using properly functioning oil/moisture traps.</li> <li>✓ Verify that air compressors have sufficient pressure and volume capabilities to clean patch area adequately in accordance with contract specifications.</li> </ul>
<b>Mixing and Testing Equipment</b>	<ul style="list-style-type: none"> <li>✓ Verify that auger flights and paddles within auger-type mixing equipment are kept free of material buildup that can result in inefficient mixing operations.</li> <li>✓ Ensure that volumetric mixing equipment such as mobile mixers are kept in good condition and are calibrated (CT-109) on a regular basis to properly proportion mixes.</li> <li>✓ Verify that the concrete testing technician meets the requirements of the contract documents for training/certification.</li> <li>✓ Ensure that material test equipment required by the specifications is all available on-site and in proper working condition (equipment typically includes slump cone, cylinder molds and lids, rod, mallet, ruler, and 10 ft [3 m] straightedge).</li> </ul>
<b>Placing and Finishing Equipment</b>	<ul style="list-style-type: none"> <li>✓ Verify that a sufficient number of concrete vibrators 1 in. (25 mm) in diameter or less are available on-site and in proper working condition.</li> <li>✓ Verify that all floats and screeds are straight, free of defects, and capable of producing the desired finish.</li> </ul>
<b>Other Equipment</b>	<ul style="list-style-type: none"> <li>✓ Ensure that a steel chain, rod, or hammer is available on-site to check for unsound concrete around the patch area.</li> <li>✓ Verify that grout-application brushes (if necessary) are available.</li> </ul>
<b>Others</b>	
<b>Weather Requirements</b>	<ul style="list-style-type: none"> <li>✓ Review manufacturers' installation instructions for requirements specific to the patch material being used.</li> <li>✓ Ensure that air and surface temperature meet manufacturer and contract requirements (typically 40 °F [4 °C] and rising) for concrete placement.</li> <li>✓ Ensure that patching does not proceed if rain is imminent.</li> </ul>
<b>Traffic Control</b>	<ul style="list-style-type: none"> <li>✓ Verify that signs and devices match the traffic control plan presented in the contract documents.</li> <li>✓ Verify that the set-up complies with the Federal Manual on Uniform Traffic Control Devices or local agency traffic control procedures.</li> <li>✓ Ensure that traffic control personnel are trained and qualified in accordance with contract documents/agency requirements.</li> <li>✓ Ensure that the repaired pavement is not opened to traffic until the patch material meets strength requirements presented in the contract documents.</li> <li>✓ Verify that signs are removed or covered when they are no longer needed.</li> <li>✓ Ensure that any unsafe conditions are reported to a supervisor (contractor or agency).</li> </ul>
<b>Project Inspection Responsibilities</b>	
<b>Patch Removal and Cleaning</b>	<ul style="list-style-type: none"> <li>✓ Ensure that the area surrounding the patch is checked for delamination and unsound concrete.</li> </ul>

	<ul style="list-style-type: none"> <li>✓ Ensure that the boundaries of unsound concrete area(s) are marked at least 2 in. (50 mm) beyond the area of deterioration.</li> <li>✓ Verify that concrete is removed by saw cutting the boundaries and jack hammering the interior concrete.</li> <li>✓ Verify that concrete removal extends at least 2 in. (50 mm) in depth and does not extend below one-third of the slab depth, and that load transfer devices are not exposed.</li> <li>✓ Verify that, after concrete removal, the patch area is prepared by sandblasting or water blasting.</li> <li>✓ Verify that the patch area is cleaned by air blasting. A second air blasting may be required immediately before placement of patch material if patches are left exposed for a period of time.</li> </ul>
<b>Patch Preparation</b>	<ul style="list-style-type: none"> <li>✓ Ensure that compressible joint inserts (joint/crack re-formers) are inserted into existing cracks/joints in accordance with contract documents. Joint inserts are typically required to extend below and outside the patch area by 1/2 in. (12 mm).</li> <li>✓ When a patch abuts a bituminous shoulder, ensure that a wooden form is used to prevent patch material from entering the shoulder joint.</li> <li>✓ Ensure that bonding agent (epoxy- or cement based) is placed on clean, prepared surface of existing concrete immediately prior to placement of patch material as required by the contract documents. If bonding agent shows any sign of drying before patch material is placed, it must be removed by sandblasting, cleaned with compressed air, and re-applied.</li> <li>✓ Verify that cement-based bonding agents are applied using a wire brush; epoxy-based bonding agents are applied using a soft brush.</li> </ul>
<b>Placing, Finishing, and Curing Patch Material</b>	<ul style="list-style-type: none"> <li>✓ Verify that quantities of patch material being mixed are relatively small to prevent material from setting prematurely.</li> <li>✓ Verify that the fresh concrete is properly consolidated using several vertical penetrations of the surface with a hand-held vibrator.</li> <li>✓ Verify that the surface of the concrete patch is level with the adjacent slab using a straightedge in accordance with contract documents. Note: To prevent pulling material away from the patch boundaries, work material from the center of the patch outward toward the boundary.</li> <li>✓ Verify that the surface of the fresh patch material is finished and textured to match the adjacent surface.</li> <li>✓ Verify that the perimeter of the patch and saw-cut runouts (if saws are used) are sealed using grout material. Alternatively, saw-cut runouts can be sealed using joint-sealant material.</li> <li>✓ Verify that adequate curing compound is applied to the surface of the finished and textured, fresh patch material in accordance with contract documents.</li> <li>✓ Ensure that insulation blankets are used when ambient temperatures are expected to fall below 40 °F (4 °C). Maintain blanket cover until concrete attains the strength required in the contract documents.</li> </ul>
<b>Resealing Joints and Cracks</b>	<ul style="list-style-type: none"> <li>✓ Verify that the compressible inserts are sawed out to the dimensions specified in the contract documents when the patch material has attained sufficient strength to support concrete saws.</li> <li>✓ Verify that joints are cleaned and resealed according to contract documents.</li> </ul>
<b>Cleanup Responsibilities</b>	
<b>General</b>	<ul style="list-style-type: none"> <li>✓ Verify that all concrete pieces and loose debris are removed from the pavement surface and disposed of in accordance with contract documents.</li> <li>✓ Verify that mixing, placement, and finishing equipment is properly cleaned for the next use.</li> </ul>

### 7.5.2 Troubleshooting Guide

The following guidelines are primarily based on guidelines from the FHWA Pavement Preservation Checklist Series ([http://www.fhwa.dot.gov/pavement/pub\\_details.cfm?id=351](http://www.fhwa.dot.gov/pavement/pub_details.cfm?id=351)) and the FHWA / NHI Course entitled “Pavement Preservation Design and Construction of Quality Preventive Maintenance Treatments”.

Problem	Description and solution
More deterioration than expected	Description: more deterioration below surface than is evident above  Solution: <ul style="list-style-type: none"> <li>• Extend limits of repair area into sound concrete.</li> <li>• If deterioration extends below one-third of the depth, do a full depth repair.</li> <li>• Ensure that the contractor’s removal operations are not damaging the base.</li> </ul>
Exposed steel	Description: dowel bar or reinforcing steel is exposed during concrete removal.  Solution: <ul style="list-style-type: none"> <li>• If steel is in the upper third of slab, remove the steel to the edges of the patch and continue.</li> <li>• If removal extends to mid-depth of the slab, do a full depth repair.</li> </ul>
Patch material in crack or joint	Description: patch material flows into joint or crack  Solution: <ul style="list-style-type: none"> <li>• Ensure joint insert extends far enough into the adjacent joint/crack and below the patch.</li> <li>• Ensure insert is correctly sized for joint/crack width.</li> </ul>
Patch cracking	Description: patch is cracking or unbonding  Solution: <ul style="list-style-type: none"> <li>• Check that joint insert is being used properly.</li> <li>• Ensure that the insert is correctly sized for the joint/crack width and that it has been inserted correctly.</li> <li>• Check that patch area was cleaned immediately prior to grouting/concrete placement.</li> <li>• Check that grout material has not dried out before concrete placement.</li> <li>• Ensure that curing compounds has been applied adequately.</li> <li>• Check that patch material is not susceptible to shrinkage.</li> </ul>

## 7.6 KEY REFERENCES

ACPA, 1989. *Guidelines for Partial-Depth Repair*, Technical Bulletin TB-003P, American Concrete Pavement Association, Arlington Heights, IL, 1989.

ACPA, 1998. *Guidelines for Partial Depth Spall Repair*, American Concrete Pavement Association, Skokie, IL, 1998.

Caltrans, 2004. *Slab Replacement Guidelines*, Sacramento, CA, January 2004.

Caltrans, 2007a. *Caltrans SSP No. 41-150 Repair Spalled Joints*, Sacramento, CA, January 2007.

- Caltrans, 2007b. *Caltrans SSP No. 41-151 Repair Spalled Joints (Polyester Grout)*, Sacramento, CA, May 2006.
- Carmichael III, R. F., A. H. Meyer, L. L. Caldwell, and B. F. McCullough, 1989. *Rapid Replacement of Portland Cement Concrete Pavement Segments*, NCHRP Research Results Digest Number 169, Transportation Research Board, Washington, DC, 1989.
- Darter, M. I., E. J. Barenberg, and W. A. Yrjanson, 1985. *Joint Repair Methods for Portland Cement Concrete Pavements*, NCHRP Report 281, Transportation Research Board, Washington, DC, 1985.
- FHWA, 2006. *Partial Depth Repairs*, Federal Highway Administration website:  
<http://www.fhwa.dot.gov/pavement/concrete/full.cfm/>
- FHWA, 1985. *Pavement Rehabilitation Manual*, Report No. FHWA-ED-88-025, Federal Highway Administration, Washington, DC (Manual supplemented April 1986, July 1987, March 1988, February 1989, October 1990), 1985.
- FHWA, 1999. *Materials and Procedures for Rapid Repair of Partial-Depth Spalls in Concrete Pavements. Manual of Practice*, Report No. FHWA-RD-99-152, Federal Highway Administration, Washington, DC, 1999.
- FHWA, 2001. *PCC Pavement Evaluation and Rehabilitation*, NHI Course 131062, Federal Highway Administration, Washington, DC, October 2001.
- FHWA, 2004. *Pavement Preservation Design and Construction of Quality Preventive Maintenance Treatments*, NHI Course 131103, Federal Highway Administration, Washington, DC, November 2004.
- FHWA, 2005. *Partial-Depth Repair of Portland Cement Concrete Pavements*, Pavement Preservation Checklist Series, Federal Highway Administration. Washington, DC, November 2005.
- Good-Mojab, C. A., A. J. Patel, and A. R. Romine, 1993. *Innovative Materials Development and Testing. Volume 5—Partial Depth Spall Repair*, SHRP-H-356, Strategic Highway Research Program, Washington, DC, 1993.
- NCHRP, 1977. *Rapid Setting Materials for Patching of Concrete*, NCHRP Synthesis of Highway Practice No. 45, National Cooperative Highway Research Program. Transportation Research Board, Washington, DC, 1977.
- Patel, A. J., C. G. Mojab, and A. R. Romine, 1993. *Concrete Pavement Repair Manuals of Practice: Materials and Procedures for Rapid Repair of Partial-Depth Spalls in Concrete Pavements*, Strategic Highway Research Program Report SHRP-H-349, Strategic Highway Research Program, Washington, DC, 1993.
- Snyder, M. B., K. D. Smith, and M. I. Darter, 1989. *An Evaluation of Pressure Relief Joint Installations*, Transportation Research Record 1215, Transportation Research Board, Washington, DC, 1989.

Wilson, T. P., K. L. Smith, and A. R. Romine, 1999a. *LTPP Pavement Maintenance Materials: PCC Partial-Depth Spall Repair Experiment*, FHWA-RD-99-153, Federal Highway Administration, McLean, VA, 1999.

Wilson, T. P., K. L. Smith, and A. R. Romine, 1999b. *Materials and Procedures for Rapid Repair of Partial-Depth Spalls in Concrete Pavement, Manual of Practice*, FHWA-RD-99-152, Federal Highway Administration, McLean, VA, 1999.

*Disclaimer*

*The contents of this guide reflect the views of the authors who are responsible for the facts and accuracy of the data presented herein. The contents do not necessarily reflect the official views or policies of the State of California or the Federal Highway Administration. This guide does not constitute a standard, specification, or regulation.*

## **CHAPTER 8 FULL DEPTH CONCRETE REPAIR**

This chapter provides an overview of isolated full depth concrete repairs. It presents a description of the effectiveness and limitations of these techniques, as well as material selection, design considerations, and construction procedures. Also included are a troubleshooting guide and a list of important factors to be considered during design and construction of this treatment.

### **8.1 PURPOSE AND DESCRIPTION OF TREATMENT**

Full depth repairs are preventive maintenance techniques that restore isolated slab structural integrity and rideability of a concrete pavement and deter further deterioration, thus extending the pavement's service life. Also, isolated full depth repairs are required to prepare an existing, distressed pavement for a subsequent structural overlay or a restoration project.

#### *8.1.1 Full Depth Repair*

Full depth repair involves a full-depth slab removal followed by cast-in-place replacement of full lane-width areas of an existing rigid pavement. Typically the minimum length requirement is 6 ft (1.8 m); however, when repair areas are closely located, it is more cost effective to substitute a larger area, up to an including the full width and length of an entire slab. Half lane widths areas are not allowed by Caltrans due to their instability.

Full depth repair can address a wide variety of distresses, including transverse and longitudinal cracks, joint spalling, and blowups. Table 8-1 shows typical distress types and severity levels where full depth repairs are generally applied.

### **8.2 MATERIALS AND SPECIFICATIONS**

A wide variety of materials are available for full depth repairs. The selection of adequate materials will depend on the project's environmental, design, and funding requirements. Repair materials include conventional portland cement concrete (PCC) mixtures, special cements, proprietary materials, and, occasionally, bituminous materials.

#### *8.2.1 Material Selection*

Repair materials are selected based on available curing time, climatic conditions, cost, equipment requirements, mixing and placing time, desired service life, and the size and depth of repairs. Material properties, such as strength gain, modulus of elasticity, bond strength, scaling resistance, sulfate resistance, abrasion resistance, shrinkage characteristics, coefficient of thermal expansion, and freeze-thaw durability, should also be included in the selection process. Repair materials must be compatible in strength and volume stability with the existing pavement.



Table 8-1 Distresses addressed by full depth repairs for jointed concrete pavements (FHWA, 2001)

Distress Type	Severity Levels that Require Full Depth Repairs
Transverse cracking	Medium, High
Longitudinal cracking	Medium, High
Corner breaks	Low, Medium, High
Spalling of joints	Medium <sup>1</sup> , High
Blowups	Low, Medium, High
Reactive aggregate spalling <sup>2</sup>	Medium <sup>1</sup> , High
Deterioration adjacent to existing repairs	Medium <sup>1</sup> , High
Deterioration of existing repairs	Medium <sup>1</sup> , High

<sup>1</sup> Partial-depth repairs can be used if the deterioration is limited to the upper one-third of the pavement slab

<sup>2</sup> If the pavement has a severe material problem (such as reactive aggregate), full-depth repairs will only provide temporary relief from roughness and further deterioration caused by spalling. Continued deterioration of the original pavement is likely to result in the redevelopment of spalling and roughness.

### 8.2.2 Cementitious Materials

PCC mixtures are the most widely used material for full depth repairs. However, specialty cement mixtures and materials have also been successfully used for full depth repairs in order to meet short opening time requirements; however their cost is much higher than conventional PCC mixtures and they are usually more difficult to handle. A good rule of thumb for selecting a material for PCC slab repairs is to use the most convenient material that meets the lane closure requirements (Caltrans, 2004).

High early strength cementitious mixtures have been widely used for full depth repairs. The high early strength can be achieved on PCC mixtures by reducing the water/cementitious ratio (w/cm), increasing the cement content, adding chemical accelerators, or by adding high-range water reducers.

Caltrans allows the contractor to select the replacement concrete material on the basis of the available lane closure time and strength requirements. Rapid Strength Concrete (RSC) shall be in conformance with Caltrans SSP No. 40-020. Caltrans uses three types of RSC mixes (Caltrans, 2004):

- Specialty or proprietary cement mixtures may be used when short construction windows are required. These mixes can meet opening strength requirements with only 2 to 4 hours of curing time under typical placement conditions.
- Mixtures of Type III portland cement with non-chloride accelerators may also be used for short construction windows and can meet opening strength requirements within 4 to 6 hours under typical placement conditions and curing times for Type III cements. A high-range water-reducing admixture may be used to disperse cement particles and reduce the extra water requirement to achieve thorough mixing.
- Mixtures of Type III portland cement with non-chloride accelerators may be used when longer construction windows are feasible. These types of mixes can achieve their strength requirements within 24 hours of curing time under typical placement conditions.

The FHWA mentions the following special cements which have been used for full depth repairs (FHWA, 2001):

- Rapid set cement (RSC), which is similar to Type K expansive cement, can provide the strength required for opening to traffic in 2 to 6 hrs. This special cement was modified to reduce the expansion difficulties usually associated with expansive Type K cements.
- Regulated set portland cement (RSPC) has similar components as ordinary portland cement, but up to 20 to 25% of the calcium aluminate phases have been replaced with calcium fluoro-aluminate. RSPC's setting time can be regulated from 2 to 30 minutes by the use of a set retarder.

Table 8-2 shows some of the properties of various cementitious materials used nationally for full depth repairs.

Table 8-2 High early-strength mix design and approximate opening times (FHWA, 2001)

Mix Component	Type I (GADOT)	Type III (Fast Track I)	Type III (Fast Track II)	RSPC	Rapid Set Cement
Cement, (lb/yd <sup>3</sup> )	755	644	745	613	652
Fly ash, (lb/yd <sup>3</sup> )	–	73	81	–	–
Course aggregate, (lb/yd <sup>3</sup> )	1803	1399	1311	1709	1808
Fine aggregate, (lb/yd <sup>3</sup> )	1034	1366	1308	1406	1006
w/cm ratio	0.40	0.40 to 0.48	0.40 to 0.48	0.41	0.45
Water reducer	–	yes	yes	–	–
Air entraining agent	As needed to obtain an air content of 6 ± 2 percent.				
CaCl <sub>2</sub> % by wt. of cement	1.0	–	–	–	–
Opening time	4 hr	24-72 hr	12-24 hr	4 hr	4-6 hr

1 kg/m<sup>3</sup> = 1.69 lb/yd<sup>3</sup>

### 8.2.3 Bituminous Materials

Bituminous materials are not recommended for permanent repairs of rigid pavements because they allow excessive horizontal movements of adjacent slabs, provide no load transfer across transverse joints, and may lead to very rapid deterioration. They should be only considered as a short-term or temporary repair.

## 8.3 ENGINEERING CONSIDERATIONS

The performance of full depth slab repairs can be highly improved through proper design. This section provides necessary design considerations for full depth repairs, such as project selection, concurrent work considerations, repair locations and boundaries, and load transfer devices.

### 8.3.1 Project Selection

Full depth repairs should be used for rigid pavements with deterioration limited to isolated slabs, not widespread over the entire project length. Structurally deficient pavements may require a structural enhancement, such as an overlay or tied rigid shoulders, instead of one or more isolated, full depth repairs. Pavements with moderate to severe material problems (e.g., ASR) and pavements with base course or subgrade problems, as indicated by differential settlements or load-deflection (Falling Weight Deflectometer) tests, are not good candidates for isolated full depth concrete repairs.

### 8.3.2 Concurrent Work

The sequence of performing full depth repairs is very important when isolated repairs are done as part of a comprehensive pavement restoration project. Slab stabilization should be done before full depth repairs in order to prevent any accidental spalling that can occur during the full depth repair project. Isolated full depth repairs should be done concurrently with or after partial depth repairs for an adjacent slab are performed. If necessary, diamond grinding should follow full depth repairs. The project is generally finished with joint resealing, as needed.

### 8.3.3 Repair Locations and Boundaries

A visual survey must be conducted to identify and mark the distressed areas. Engineering judgment, coring, load-deflection (FWD) studies, and sounding techniques such as striking the concrete surface with a hammer, steel rod, or by dragging a chain, should be used to define the extent of the deterioration beneath the surface and determine repair boundaries.

Caltrans specifies that a replacement slab or a full depth repair joint must be at least 6.6 ft (2 m) from the nearest crack or joint (Caltrans, 2004).

FHWA recommends the following minimum repair dimensions for full depth repairs (FHWA, 2001):

- Doweled or Tied Repair—A minimum length of 6 ft (1.8 m) and a full-lane-width repair are recommended to minimize rocking, pumping, and breakup of the slab (Darter, Barenberg, and Yrjanson 1985; Snyder et al. 1989).
- Non-doweled or Non-tied Repair—The minimum recommended repair lengths are 6 ft (1.8 m) for pavements with low truck traffic volumes and 8 to 10 ft (2.4 to 3.0 m) for pavements with medium to high traffic volumes.
- Partial-lane-width repairs are generally not recommended due to their relative instability.

FHWA also provides the following guidelines on developing repair boundaries for jointed concrete pavement (FHWA, 2001):

- Long-length repairs have a tendency to crack at mid-slab; therefore, repairs longer than 10 to 13 ft (3 to 4 m) should be constructed with either an intermediate joint to prevent cracking or using steel reinforcement to hold the cracks tight, should cracking occur (Darter, Barenberg, and Yrjanson, 1985, Carmichael et al, 1989).
- The repair boundary should not be too close to an existing transverse crack or joint; otherwise, adjacent slab distress will likely occur. A minimum distance of 6 ft (1.8 m) is recommended from the full-depth repair joint to the nearest transverse crack or joint (Darter, Barenberg, and Yrjanson, 1985; ACPA, 1995).
- A boundary that would fall at an existing, doweled transverse joint (distress evident on one side of the joint only) should be extended 1 ft (0.3 m) to include the existing joint. Attempts at salvaging the existing dowel system, even if the dowels are properly aligned and corrosion-free, frequently result in damage to dowel bars and the adjacent slab during the concrete breakup and cleanout operations (ACPA, 1995, FHWA, 1985). If distress is present on only one side of an existing, non-doweled joint, that joint may be used as a boundary.
- Cracks located 10 ft (3 m) or farther from the joint can be repaired individually or, if severe enough, the entire slab can be replaced.

Caltrans specifies that the absolute minimum slab repair should be the full slab width by 6.5 ft (2 m) and the repair slab should be at least 6.5 ft (2 m) from the nearest crack of joint (Caltrans, 2004). Any

repair longer than 15 ft (4.6 m) shall be provided with a new transverse joint (Caltrans, 2004 and Caltrans, 2006a).

### 8.3.4 Load Transfer Devices

Proper load transfer design at transverse joints is essential to the performance of full depth repairs. Adequate load transfer devices minimize differential movement of the slabs which causes spalling, rocking, pumping, faulting and breakup of adjacent slabs. The use of mechanical load transfer devices is highly recommended for any expected level of traffic. Residential streets with less than a 100 trucks or buses per year should be the only type of roadway where aggregate interlock alone may be adequate to transfer the loads between adjacent concrete slabs.

Mechanical load transfer devices include:

- Dowel bars—Dowel bars are smooth steel bars used at transverse joints. They allow free horizontal movement of the slabs. For full depth repairs, at least one doweled joint should be installed to allow free horizontal movement of the repair area.
- Tie bars—Tie bars are deformed rebars used along the longitudinal joint, usually 1 in. (25 mm) in diameter. Tie bars are anchored into the existing slab. These bars allow no horizontal movement of the joint and should be epoxy-coated to improve corrosion resistance.

The use of 1.8 ft. (45 mm) long and 1.5 inch (40 mm) diameter dowel bars is recommended for most interstate pavements; 1.25 in. (30-35 mm) diameter dowel bars may be acceptable for light traffic and for pavements less than 10 inches (250 mm) thick. The use of 1 inch (25 mm) diameter dowel bars for full depth repairs is discouraged because they have proved to be inadequate to withstand the bearing stresses in repair joints (ACPA, 1995). Caltrans does not recommend the use of dowel bars for pavements less than 7 inches (180 mm) thick (Caltrans, 2004).

Caltrans provide the following guidelines for load transfer design (Caltrans, 2004):

- 3 dowel bars spaced 1 ft. (300 mm) on center in each wheel track for non-truck lanes
- 4 dowel bars spaced 1 ft. (300 mm) on center in each wheel track for truck lanes
- Since lane striping is subject to change, Caltrans has allowed for the use of 9 dowel bars spaced evenly across the transverse joint. However, a design which concentrates the bars in the wheel tracks with a spacing of 1 ft. (300 mm) is highly recommended.
- If the location of striping is uncertain, use 12 dowel bars at 1 ft. (300 mm) spacing.
- For new transverse joints located 7.5 ft. (2.3 m) or less from the existing slab transverse joint, tie bars may be installed at 2 ft. (600 mm) on center along the new construction joint in lieu of dowel bars.

The dowel bar design shown in Figure 8-1 is recommended by Caltrans for truck lanes (Caltrans, 2006a).

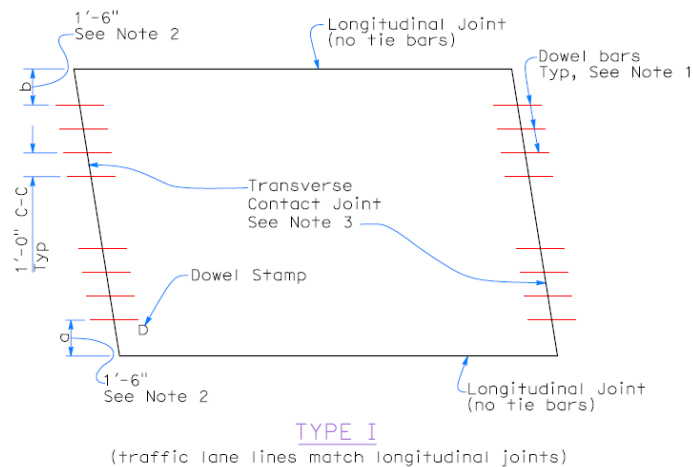

**NOTES:**

1. For details not shown see Standard Plan P10.
2. Where the existing outer shoulder pavement is asphalt concrete pavement, the "a" dimension shall be 1'-0" and the "b" dimension shall be 2'-0".
3. For detail see Transverse Contact Joint for existing concrete pavement detail on Standard Plan P10.

Figure 8-1 Caltrans dowel bar design (Caltrans Standard Plan P8, 2006)

8.3.5 Typical Item Codes

Typical Caltrans item codes for a full depth concrete repair project are given in Table 8-3.

Table 8-3 Typical item codes for an isolated full depth concrete repair project

Item Code	Description
120090	Construction area signs
120100	Traffic control system
128650	Portable changeable message sign
150846	Remove concrete pavement
150306	Repair spalled concrete
156515	Repair spalled and unsound surface area
401108	Replace concrete pavement (rapid strength concrete)
406100	Dowel bar retrofit
413101	Repair corner breaks
413111	Repair spalled joint
413114	Replace joint seal (existing concrete pavement)
413115	Seal joint (existing concrete pavement)
420201	Grind existing concrete pavement
511040	Concrete surface finish
511055	Concrete surface texture
515028	Repair spalled surface area

*Note: Standard special provision must be referred for specific item codes proposed for the project.*

Caltrans Standard Materials and Supplemental Work Item Codes are found at the following web site:

[http://i80.dot.ca.gov/hq/esc/oe/awards/#item\\_code](http://i80.dot.ca.gov/hq/esc/oe/awards/#item_code)

## 8.4 CONSTRUCTION PROCESS

### 8.4.1 *Traffic Control and Safety*

Traffic control is required for the safety of the traveling public and construction personnel alike. Traffic control should be enforced before equipment or personnel enter the work zone. Caltrans project specifications and the Caltrans Code of Safe Operating Practice should be strictly followed. Traffic is not allowed on repair areas until the curing period and the joint sealing process are completed.

Depending on the project location, size, and amount of repair work, one of the following types of traffic control alternatives may be considered:

- Complete roadbed closure
- Continuous lane closure
- Weekend closure
- Nighttime closure

### 8.4.2 *Equipment*

Equipment requirements vary according to the treatment method and the material selected. This will be described in more detail in Sections 8.4.3 through 8.4.11.

Equipment may be required for:

- Sawing and material removal
- Cleaning
- Installation of load transfer devices
- Repair material placement
- Finishing
- Curing
- Joint sealing

### 8.4.3 *Repair Locations*

As mentioned in section 8.3.3, defining the location and boundaries of the repair needs to be performed by experienced personnel through a field survey. The field survey should be complemented with other measures, such as coring or FWD deflection testing to define the extent of deterioration beneath the surface and to determine the repair boundaries. This survey should be performed as near as possible to the time of construction and should include additional distressed areas that have occurred since the previous pavement inspection. Distress areas and repair boundaries should be marked on the pavement surface.

#### 8.4.4 Concrete Sawing and Removal

Concrete sawing for full depth repairs can be accomplished by the two following transverse joint saw cutting procedures:

- **Rough-faced**—A diamond-bladed saw is used to outline the repair boundaries. The saw cut should not penetrate more than 30% of the slab depth. Jackhammers are used to break the deteriorated slab, thus allowing the resulting rough face to provide adequate aggregate interlock between the new repair material and the old pavement. A distinct disadvantage of this procedure is the high potential of spalling beneath the slab during concrete removal operations.
- **Smooth-faced**—The transverse joint is sawed to its full depth. No aggregate interlock is obtained with this procedure. The use of mechanical joint load transfer devices is highly recommended, especially for heavy trafficked pavements.

Caltrans specifies full-depth saw cuts around the entire perimeter of the distressed area that will be removed. The repaired area must be at least 6½ ft (2 m) long. Additionally, any remaining concrete adjacent to the repaired area must also be at least 6½ ft (2 m) long. Any repair that does not meet these requirements should be treated as a slab replacement and not as an isolated full depth repair (Caltrans, 2004).

Traffic loading must be limited between the time of sawing and concrete removal to avoid pumping and erosion beneath the slab. No more than 2 days of traffic over the sawed repair areas before concrete removal begins is recommended (FHWA, 2001).

#### ***Saw Cutting Special Considerations***

On hot days (with temperatures greater than 100 °F or 40 °C), a wide pressure relief cut will be needed to prevent spalling of the adjacent concrete during removal due to thermal expansion. The commonly used carbide-tipped wheel saw generally promotes excessive spalling along the joint. If a wheel saw is used, diamond sawcuts must be made at least 18 in. (460 mm) outside the wheel sawcuts. Additionally, the wheel saw should not intrude into adjacent slabs, and must not be allowed to penetrate into the subbase more than ½ inch (15 mm) or so. Another alternative to avoid the need of pressure relief cuts is to saw at night during cooler temperatures.

Caltrans provides the following guidelines for saw cutting (Caltrans, 2004):

- Saw the concrete in rectangular sections to simplify concrete removal
- Do not make notches or diagonal cuts in the pavement
- Each area of concrete to be replaced will receive a sawcut through the existing slab, around its entire perimeter. Additional sawing of individual panels may be required for removal.
- Sawcuts through the existing slab are required to separate the removal area from the surrounding concrete.
- Water residue from concrete cutting should be removed immediately by vacuuming.
- Saw cuts made prior to the actual removal work shift should not include any cuts made closer than 1 m (3 feet) to another cut, joint or crack, so as to avoid creating small pieces of concrete that could be dislodged by traffic.

In areas with extensive deterioration, repair costs can be reduced by removing and replacing large areas of concrete; this procedure is also called “slab replacement.” A slab replacement pay item should be additionally included for any larger repair areas.

### **Concrete Removal**

Caltrans does not allow any removal techniques that may damage the remaining in-place pavement and base. Non-impact methods shall be used during concrete removal activities.

After boundary cuts have been made, deteriorated concrete can be removed by the **Lift-Out Method**. Lift pins are installed in the distressed slabs, which are vertically lifted by the use of chains and a front-end loader or other suitable equipment. Adequate equipment and procedures shall be employed to avoid damage to adjacent slabs and disturbing the existing subbase. This method minimizes disturbances to the base, provides the best results, and is very effective (see Figure 7-5).

Impact methods, such as the **Breakup and Cleanout Method**, may be allowed when the treated base needs to be removed along with the concrete. The deteriorated concrete is broken into smaller pieces by using a jackhammer, drop hammer, or hydraulic ram, and then removed by the use of a backhoe and hand tools. Demolition equipment should not be allowed near sawed joints. Breakup should begin at the center of the repair area, never at the edges. This method generally results in great disturbances to the subbase and subgrade, and usually requires either replacement of these layers or filling with portland cement concrete (PCC) or lean concrete base depending on the time window and cement type employed.



Figure 8-2 Concrete removal using Lift-Out Method (Caltrans, 2004)

#### **8.4.5 Cleaning and Repair Area Preparation**

The repair area should be clean of all debris from the demolition stage. If subbase and/or subgrade material has been disturbed, or if pockets of loose or missing material are identified, they should be removed and replaced with similar materials or with concrete. If excessive moisture is present, it should be dried out or removed and replaced before placement of the repair material. The need for lateral drainage should be evaluated before continuing the repair work. This procedure may not be practical for typically tight Caltrans work windows.



Compaction of granular material in confined areas is difficult. In these cases, replacement of damaged subbase material with PCC or lean concrete base may be the best option. Caltrans recommends the use of rapid strength concrete (RSC) for base repairs. A bond breaker shall be used to separate the treated base from the concrete pavement (Caltrans, 2004). In these cases, the treated base layer should be allowed to cure and gain sufficient strength before a new slab is poured.

#### 8.4.6 Provision of Load Transfer

Adequate installation of mechanical load transfer devices reduces differential movement between slabs and is critical to the performance of full depth repairs. Load transfer devices such as dowel bars can be employed to provide for adequate load transfer across repair joints. At least one doweled joint should be provided to the repair to allow for horizontal movements.

Holes should be drilled at mid-depth of the exposed face of the existing slab with equipment that allows for proper horizontal and vertical alignment. Single, hand-held drills are not permitted because of the likelihood of misalignment. Proper hole alignment is critical to full depth repair performance. Standard pneumatic and hydraulic percussion drills are acceptable for drilling dowel holes. Electric-pneumatic drills should be avoided due to their inadequately slow production rate.

Drilled hole diameters should be large enough to allow room for the dowel and the anchoring material. Table 8-4 provides recommendations for dowel hole diameter (Snyder et al, 1989).

Table 8-4 Anchoring materials and dowel hole recommendations

Anchoring material	Dowel hole diameter	Comments
Cement grout	Dowel diameter + 0.25 in. (6 mm)	Plastic grout mixtures provide better support to dowels than fluid mixtures.
Epoxy material	Dowel bar + 1/6 in. (2 mm)	Due to epoxy materials' flexibility compare to the surrounding concrete, a thin layer is desirable to reduce mortar deformation and dowel deflection.

Anchoring the dowels is critical to the performance of full depth repairs. The following procedure is recommended for anchoring dowel bars (See Figure 8-3) (FHWA, 1985, Snyder et al, 1989, ACPA, 1995):

1. Remove debris and dust from the dowel holes by blowing them out with air. If the holes are wet, they should be allowed to dry before installing dowels. Oil will prevent good bonding. Always check the air for oil and moisture contamination from the compressor.
2. Place quick-setting, non-shrinking cement grout or epoxy resin in the back of the dowel hole. The grout can be placed by using a flexible tube with a long nose that places the material in the back of the hole. Epoxy-type materials can be placed using a cartridge with a long nozzle that dispenses the material to the rear of the hole.
3. Optionally, place a grout retention disk (a thin donut-shaped plastic disk) over the dowel and against the slab face, as illustrated in figure 8-3. This prevents the anchoring material from flowing out of the hole and helps create an effective face at the entrance of the dowel hole (the location of the critical bearing stress).
4. Insert the dowel into the hole with a slight twisting motion so that the material in the back of the hole is forced up and around the dowel bar. This ensures a uniform coating of the anchoring material over the dowel bar.
5. The protruding end of the dowel should be slightly greased to facilitate horizontal movement.

Caltrans recommends using a long nozzle that feeds the cement grout or epoxy resin to the back of the dowel hole. This ensures that the anchoring material will flow forward along the entire dowel embedment length during insertion and will also decrease the likelihood of leaving voids between the dowel bar and the concrete (Caltrans, 2004).

Caltrans also recommends the use of a cap or grout retention disk, if a non-shrink cement mix is used. All cements that are not portland-type cement are considered non-shrink. Dowel bars that are drilled and bonded with epoxy do not need caps on the side placed in the drilled hole (Caltrans, 2004).

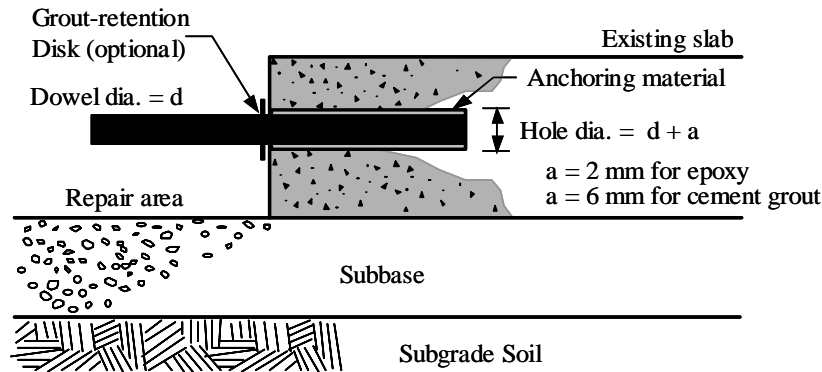

Figure 8-3 Dowel bar anchoring in slab face (FHWA, 2001)

FHWA recommends the use of tie bars for full slab replacement and full depth repairs longer than 15 ft. (4½ m). Tie bars should be installed using the same procedures used for dowel bar installation. Typically, dowel bars are spaced along the longitudinal joint at 30 inch (750 mm) intervals. This information can be found at the Federal Highway Administration website at the following URL:

<http://www.fhwa.dot.gov/pavement/concrete/full.cfm>

Caltrans requires tie bars between existing slabs and “newly placed” concrete, if the existing pavement is already equipped with tie bars. Tie bars mainly help to keep adjacent lanes of slabs from separating (Caltrans, 2004).

#### 8.4.7 Joint Preparation

##### Transverse Joints

Caltrans requires the installation of a ¼ in. (6 mm) thick, commercial quality polyethylene, flexible foam expansion material across each transverse joint. This material must be securely placed and shall extend along the slab face, with the top of the expansion material flush with the top of the pavement. In addition, expansion material must be cut to fit with the holes for drill-and-bond dowels (Caltrans, 2004).

##### Longitudinal Joint

Full depth repairs less than 15 ft (4½ m) long, place a bond breaking board along any longitudinal face with an existing concrete lane or concrete shoulder. A thin, 0.20 in (5 mm) fiberboard or similar material should match the repair area depth and length and sit flush with the longitudinal face of the

repair. The bond breaker allows the patch and the old concrete to move independently. (FHWA <http://www.fhwa.dot.gov/pavement/concrete/full.cfm>).

Caltrans does not require the use of expansion materials along longitudinal joints for pavement repairs unless the joints of adjacent pavement slabs do not match. The expansion material must be placed securely across the entire length of the joint and extend along the height of the slab, with the top of the expansion material flush with the top of the pavement joint (Caltrans, 2004).

#### 8.4.8 Bond Breaker

Caltrans recommends the application of a suitable bond breaker, such as plastic sheeting or curing paper, over the prepared base. The bond breaker will allow the slab and the base to move independently of one another. Other bond breaker materials may be used per contract specifications. The base replacement material and the RSC pavement shall not be placed in a monolithic pour (Caltrans, 2004).

#### 8.4.9 Materials Placement

##### **Clean Surface**

Before placing the bonding agent and the repair material, it is necessary to make sure the repair area is thoroughly clean and dry.

##### **Placement**

Careful control of mixing times and water content is very important because of the quick setting nature of the materials used in full depth repairs. Do not allow the addition of extra water to the wet concrete in order to achieve “greater workability,” because this may result in a reduction in concrete strength and an increase in concrete shrinkage.

Portland cement concrete and most proprietary repair materials should not be installed under adverse conditions, such as air or pavement temperatures below 40 °F (4 °C) or in wet substrates. Placement under temperatures below 55 °F (13 °C) requires the use of warm water, insulation covers, and longer curing times.

Consolidation is usually achieved more consistently by the use of vibrating screeds. High-frequency, internal vibrators can also be used to consolidate RSC, but vibrators are not permitted for shifting of the RSC mass. The use of a vibrating screed parallel to the pavement’s centerline is recommended for full depth repairs.

During placement, a slight over-filling of the repair area should be allowed to account for volume reduction during consolidation. It is also important to ensure that the concrete is well vibrated over the entire repair area, especially around the edges of the repair to avoid over finishing.

#### 8.4.10 Finishing

A critical aspect of full depth repairs is to obtain a level finish of the repair area with the surrounding pavement. To provide adequate skid resistance and a smooth transition, the surface of the repair should be textured to match that of the existing pavement. In full depth repairs, the repair material should be struck off two or three times in a transverse direction to make it flush with the existing pavement.

#### 8.4.11 Curing

Adequate attention to curing will reduce the development of shrinkage cracking and promote more complete cement hydration by preventing moisture loss from the concrete. Proper curing is even more important when accelerating admixtures are used. Curing procedures shall be in conformance with Caltrans Standard Specifications, Section 90-7 “Curing Concrete.”

In hot weather (over 100 °F or 40 °C), the use of pigmented curing compounds is highly recommended over other curing procedures (e.g. moist burlap or polyethylene). Caltrans recommends a nominal rate of application of 150 ft<sup>2</sup>/gal (4 m<sup>2</sup>/L), unless otherwise specified (Caltrans Standard Specifications Section 90-7). ACPA recommends an application rate of about 200 ft<sup>2</sup>/gal (5 m<sup>2</sup>/L). Insulation mats are not necessary in hot weather, and if used can result in concrete cracking (ACPA, 1989).

In cold weather (less than 50 °F or 10 °C), the use of insulating blankets and tarps can accelerate hydration and promote higher early strength, thus allowing for earlier opening to traffic. Special care is required during the removal of insulation blankets, because rapid cooling of the pavement surface can cause pavement cracking. When large temperature differences exist between the concrete and air temperatures, insulation blankets should not be removed from the repair area.

Curing time and other procedures for the use of epoxy and proprietary materials should follow the manufacturer’s recommendations.

#### 8.4.12 Joint Sealing

Joint sealing will reduce spalling and minimize water infiltration. Both longitudinal and transverse repair joints should be sealed. The joints should be sawed or formed, sandblasted, and air blasted. A backer rod should be inserted and joint sealant applied. More detail information on joint sealing can be found in Chapter 4 of this document.

Timing for sawing of intermediate joints is crucial. Sawing too early can lead to spalling along the cut or dislodging of aggregate particles, while sawing too late can result in random cracking in the repaired area.

#### 8.4.13 Opening to Traffic

Repair materials must have gained sufficient strength before it is opened to traffic. Caltrans requires a minimum flexural strength of 400 psi (2.8 MPa), as determine in accordance with CTM 523, for slab replacement (Caltrans, 2004). The FHWA provides the following criteria for full depth repairs to specify when the pavement may be opened to traffic (FHWA, 2001):

- **Minimum strength.** An agency may stipulate that the repair attain a minimum strength before it is opened to traffic. Recommended minimum strength requirements are as follows (Darter, Barenberg, and Yrjanson, 1985; Whiting et al, 1994):
  - Compressive Strength: 2,000 psi (13.8 MPa).
  - Modulus of Rupture: 300 psi (2.1 MPa) center-point loading, or 250 psi (1.7 MPa) third-point loading.
- **Minimum time to opening.** Minimum time to opening to traffic should be based on the mix design, curing procedure, ambient temperature at placement, and slab thickness.

It is preferable to have a measure of the actual concrete strength before allowing the repair area to be opened to traffic, especially if very early opening is required (e.g., 4 hrs or less curing time). On such projects, maturity meters or pulse-velocity devices can be used to monitor concrete strength (ACPA, 1995).

#### 8.4.14 Job Review-Quality Issues

Quality control and workmanship are critical to the performance of full depth repairs. A cooperative effort between the Caltrans and the contractor’s representatives are very helpful in order to conduct effective inspections of all construction procedures, materials, and project equipment before and during the project. Careful project inspections allow earlier detection and correction of deficiencies in workmanship, equipment, and materials, thus resulting in an improved end product.

Improper construction, placement techniques, or material deficiencies have been the most frequent quality concerns related to poor performance of isolated full depth repairs. Frequent causes of failure include improper preparation of repair areas, inadequate placement of load transfer devices, insufficient consolidation, and improper use of repair materials as well as incompatibility in thermal expansion between the repair material and the original slab.

### 8.5 PROJECT CHECKLIST AND TROUBLESHOOTING GUIDE

The project checklist and the troubleshooting guide, included in this section, provide important information which can help troubleshooting and improve performance of the repair areas. The project checklist describes important aspects, such as preliminary responsibilities, material and equipment requirements, project inspection responsibilities, and cleanup responsibilities, all of which should be considered in order to promote a successful project. This troubleshooting guide describes common problems encountered during construction and their solutions.

#### 8.5.1 Project Checklist

The following checklist is primarily based on guidelines from the FHWA Pavement Preservation Checklist Series ([http://www.fhwa.dot.gov/pavement/pub\\_details.cfm?id=351](http://www.fhwa.dot.gov/pavement/pub_details.cfm?id=351)) and the FHWA / NHI Course titled “Pavement Preservation Design and Construction of Quality Preventive Maintenance Treatments”.

<b>Preliminary Responsibilities</b>	
<b>Project Review</b>	<ul style="list-style-type: none"> <li>✓ Verify that pavement conditions have not significantly changed since the project was designed and that full-depth repair is appropriate for the pavement.</li> <li>✓ Check estimated number of full-depth repairs against the number specified in the contract.</li> <li>✓ Agree on quantities to be placed, but allow flexibility if additional deterioration is found below the surface.</li> </ul>
<b>Document Review</b>	<ul style="list-style-type: none"> <li>✓ Bid/project specifications and drawings</li> <li>✓ Special provisions</li> <li>✓ Traffic control plan</li> <li>✓ Manufacturers’ instructions and recommendations</li> <li>✓ Material safety data sheets</li> </ul>

<b>Materials Checks</b>	
<b>Concrete patch material</b>	<ul style="list-style-type: none"> <li>✓ Verify that concrete patch material is being produced as required by contract documents.</li> <li>✓ Verify that the mix design for the material being supplied meets the criteria of the contract documents.</li> <li>✓ Verify that concrete patch material has been sampled and tested prior to installation, and is not contaminated.</li> </ul>
<b>Load transfer devices</b>	<ul style="list-style-type: none"> <li>✓ Verify that load transfer units (dowels) meet specifications and that dowels are properly coated with epoxy (or other approved material) and free of any minor surface damage in accordance with contract documents.</li> <li>✓ Verify that dowel-hole cementing grout meets specifications.</li> </ul>
<b>Other materials</b>	<ul style="list-style-type: none"> <li>✓ Verify that bond-breaking board meets specifications (typically asphalt-impregnated fiberboard).</li> <li>✓ Verify that joint sealant material meets specifications.</li> </ul>
<b>General</b>	<ul style="list-style-type: none"> <li>✓ Verify that sufficient quantities of materials are on hand for completion of the project.</li> <li>✓ Ensure that all material certifications required by contract documents have been provided to the agency prior to construction.</li> </ul>
<b>Equipment Inspections</b>	
<b>Concrete Removal Equipment</b>	<ul style="list-style-type: none"> <li>✓ Verify that concrete saws and blades are in good condition and of sufficient diameter and horsepower to adequately cut the required patch boundaries.</li> <li>✓ Verify that required equipment used for concrete removal is all on-site and in proper working order and of sufficient size, weight, and horsepower to accomplish the removal process (including front-end loader, crane, fork lift, backhoe, skid steer, and jackhammers).</li> </ul>
<b>Patch Area Preparation Equipment</b>	<ul style="list-style-type: none"> <li>✓ Verify that the plate compactor is working properly and capable of compacting subbase material.</li> <li>✓ Verify that gang drills are calibrated, aligned, and sufficiently heavy and powerful enough to drill multiple holes for dowel bars.</li> <li>✓ Verify that air compressors have oil and properly functioning moisture filters/traps. Prior to use, check the air stream for water and/or oil by passing the stream over a board, then examining the board for contaminants.</li> </ul>
<b>Testing Equipment</b>	<ul style="list-style-type: none"> <li>✓ Verify that the concrete testing technician meets the requirements of the contract documents for training/certification.</li> <li>✓ Ensure that all material test equipment required by the specifications is available onsite and in proper working condition (typically including rod, mallet, ruler, and 10 ft [3 m] straightedge).</li> <li>✓ Ensure that sufficient storage area on the project site is specifically designated for the storage of concrete cylinders.</li> </ul>
<b>Placing and Finishing Equipment</b>	<ul style="list-style-type: none"> <li>✓ Verify that handheld concrete vibrators are the proper diameter and operating correctly.</li> <li>✓ Verify that all floats and screeds are straight, free of defects, and capable of producing the desired finish.</li> <li>✓ Verify that sufficient polyethylene sheeting is readily available on-site for immediate deployment as rain protection of freshly placed concrete, should it be required.</li> </ul>
<b>Others</b>	
<b>Weather Requirements</b>	<ul style="list-style-type: none"> <li>✓ Verify that air and surface temperatures meet contract requirements (typically a minimum of 40 °F [4 °C] and rising) for concrete placement.</li> <li>✓ Patching should not proceed if rain is imminent. Patches that have been completed should be covered with polyethylene sheeting to prevent rain damage.</li> </ul>

<b>Traffic Control</b>	<ul style="list-style-type: none"> <li>✓ Verify that signs and devices match the traffic control plan presented in the contract documents.</li> <li>✓ Verify that the setup complies with the Federal Manual on Uniform Traffic Control Devices or local agency traffic control procedures.</li> <li>✓ Verify that traffic control personnel are trained/qualified in accordance with contract documents and agency requirements.</li> <li>✓ Ensure that the repaired pavement is not opened to traffic until the patch material has met the minimum strength specified in the contract documents.</li> <li>✓ Ensure that signs are removed or covered when they are no longer needed.</li> <li>✓ Verify that any unsafe conditions are reported to a supervisor (contractor or agency).</li> </ul>
<b>Project Inspection Responsibilities</b>	
<b>Concrete Removal and Cleanup</b>	<ul style="list-style-type: none"> <li>✓ Verify that the boundaries of the removal areas are clearly marked on the pavement surface and the cumulative area of the pavement to be removed is consistent with quantities in the contract documents.</li> <li>✓ Verify that the patch size is large enough to accommodate a gang-mounted dowel drilling rig, if one is being used. Note: The minimum longitudinal length of patch is usually 6 ft (1.8 m).</li> <li>✓ Verify that boundaries are sawed vertically the full thickness of the pavement.</li> <li>✓ Verify that concrete is removed using the lift-out method and minimizing disturbance to the base or subbase as much as possible.</li> <li>✓ Verify that after concrete removal, disturbed base or subbase is re-compacted, and additional subbase material is added and compacted if necessary.</li> <li>✓ Verify that concrete adjoining the patch is not damaged or undercut by the concrete-removal operation.</li> <li>✓ Ensure that removed concrete is disposed of in the manner described in the contract documents.</li> </ul>
<b>Patch Preparation</b>	<ul style="list-style-type: none"> <li>✓ Verify that dowel holes are drilled perpendicular to the vertical edge of the remaining concrete pavement using an appropriate drill rig.</li> <li>✓ Verify that holes are thoroughly cleaned using compressed air.</li> <li>✓ Verify that approved cement grout or epoxy is placed in dowel holes, from back to front.</li> <li>✓ Verify that dowels are inserted with a twisting motion, spreading the grout along the bar inside the hole. A grout-retention disk can be used to keep the grout from seeping out of the hole.</li> <li>✓ Verify that dowels are installed in transverse joints to the proper depth of insertion and at the proper orientation (parallel to the centerline and perpendicular to the vertical face of the sawcut excavation) in accordance with contract specifications. Typical tolerances measured perpendicularly to the sawed faced are 1/4 in. (6 mm) misalignment per 12 in. (300 mm) of dowel bar length.</li> <li>✓ Verify that tiebars are installed at the proper location, to the proper depth of insertion, and to the proper orientation in accordance with contract documents. When the length of the longitudinal joint is 15 ft (4.5 m) or greater, tiebars are typically installed in the manner used for dowels. When the length of the longitudinal joint is less than 15 ft (4.5 m), a bond-breaker board is placed along the length of the patch to isolate it from the adjacent slab.</li> <li>✓ Ensure that tiebars are checked for location, depth of insertion, and orientation (perpendicular to centerline and parallel to slab surface).</li> </ul>
<b>Placing, Finishing, and Curing Concrete</b>	<ul style="list-style-type: none"> <li>✓ Concrete is typically placed from ready-mix trucks or mobile mixing vehicles in accordance with contract specifications.</li> <li>✓ Verify that the fresh concrete is properly consolidated using several vertical</li> </ul>

	penetrations of the concrete surface with a handheld concrete vibrator. ✓ Verify that the surface of the concrete patch is level with the adjacent slab using a straightedge or vibratory screed in accordance with contract documents. ✓ Verify that the surface of the fresh concrete patch is finished and textured to match adjacent surfaces. ✓ Verify that adequate curing compound is applied to the surface of the fresh concrete immediately following finishing and texturing in accordance with contract documents. Note: Best practice suggests that two applications of curing compound be applied to the finished and textured surface, one perpendicular to the other. ✓ Ensure that insulation blankets are used when ambient temperatures are expected to fall below 40 °F (4 °C). Maintain blanket cover until concrete attains the strength required in the contract documents.
<b>Resealing Joints and Cracks</b>	✓ Verify that patches have attained adequate strength to support concrete saws, patch perimeters and other unsealed joints are awed off to specified joint reservoir dimensions. ✓ Verify that joints are cleaned and resealed according to contract documents.
<b>Cleanup Responsibilities</b>	
<b>General</b>	✓ Verify that all concrete pieces and loose debris are removed from the pavement surface. ✓ Verify that old concrete is disposed of according to contract documents. ✓ Verify that mixing, placement, and finishing equipment is properly cleaned for the next use. ✓ Verify that all construction-related signs are removed when opening pavement to normal traffic.

### 8.5.2 Troubleshooting Guide

The following guide is primarily based on guidelines from the FHWA Pavement Preservation Checklist Series ([http://www.fhwa.dot.gov/pavement/pub\\_details.cfm?id=351](http://www.fhwa.dot.gov/pavement/pub_details.cfm?id=351)) and the FHWA / NHI Course titled “Pavement Preservation Design and Construction of Quality Preventive Maintenance Treatments”.

Problem	Description and solution
Undercut spalling	Description: deterioration on bottom of slab on sound concrete surrounding the patch area, evident after removal of deteriorated concrete from the patch. Solution: <ul style="list-style-type: none"> <li>• Saw back into adjacent slab until sound concrete is encountered.</li> <li>• Make double saw cuts, 6 in. (150 mm) apart, around patch area to reduce damage to adjacent slabs during concrete removal.</li> <li>• Use a carbide-tipped wheel saw to make pressure-relief cuts 4 in. (100 mm) wide inside the area to be removed.</li> </ul>
Saw binds	Description: saw blade getting stuck to pavement when cutting full depth exterior cuts. Solution: <ul style="list-style-type: none"> <li>• Shut down saw and remove blade from saw.</li> <li>• Wait for slab to cool, then release blade if possible, or make another cut inside the area to be removed to provide a small pie-shaped piece adjacent to the stuck saw blade.</li> </ul>



Problem	Description and solution
	<ul style="list-style-type: none"> <li>• Make transverse saw cuts when the pavement is cool.</li> <li>• Use a carbide-tipped wheel saw to make pressure-relief cuts 4 in. (100 mm) wide inside the area to be removed.</li> </ul>
Adjacent slab damage	<p>Description: lifting out a patch for a full depth repair damages adjacent slab.</p> <p>Solution:</p> <ul style="list-style-type: none"> <li>• Adjust lifting cables and re-position lifting device to assure a vertical pull.</li> <li>• Re-saw and remove broken section of adjacent slab.</li> <li>• Use a forklift or crane instead of a front-end loader.</li> </ul>
Slab disintegration	<p>Description: slabs disintegrates when attempts are made to lift it out</p> <p>Solution:</p> <ul style="list-style-type: none"> <li>• Complete removal of patch area with backhoe or shovels.</li> <li>• Angle the lift pins and position the cables so that fragmented pieces are bound together during liftout.</li> <li>• Keep lift height to an absolute minimum on fragmented slabs.</li> </ul>
Patch filled with water	<p>Description: patches become filled with rainwater or groundwater seepage, saturating the subbase.</p> <p>Solution:</p> <ul style="list-style-type: none"> <li>• Pump the water from the patch area, or drain it through a trench cut into the shoulder.</li> <li>• Re-compact subbase if necessary to a density consistent with contract documents, adding material as necessary.</li> <li>• Allow small depressions in subbase to be filled with aggregate dust or fine sand before patch material is placed. Permit the use of aggregate dust or fine sand to level small surface irregularities (1/2 in. [12 mm]) in surface of subbase before concrete patch is placed.</li> </ul>
Grout flow out of dowel holes	<p>Description: grout around dowel bars flows back out of the holes after dowels are inserted.</p> <p>Solution:</p> <ul style="list-style-type: none"> <li>• Pump grout to the back of the hole first.</li> <li>• Use a twisting motion when inserting the dowel.</li> <li>• Add a grout retention disk around the bar to prevent grout from leaking out.</li> </ul>
Misaligned dowels	<p>Description: dowels appear to be misaligned once they are inserted into holes</p> <p>Solution:</p> <ul style="list-style-type: none"> <li>• If misalignment is less than 6 mm (1/4 in.) per 300 mm (12 in.) of dowel bar length, do nothing.</li> <li>• If misalignment is greater than 1/4 in. (6 mm) per 12 in. (300 mm) of dowel bar length on more than three bars, re-saw patch boundaries beyond dowels and re-drill holes.</li> <li>• Use a gang-mounted drill rig referenced off the slab surface to drill dowel holes.</li> </ul>

## 8.6 KEY REFERENCES

- ACPA, 1995. *Guidelines for Full-Depth Repair*, Technical Bulletin TB002.02P, American Concrete Pavement Association, Skokie, IL, 1995.
- Caltrans, 2004. *Slab Replacement Guidelines*, Sacramento, CA, January 2004.
- Caltrans, 2006a. *Standard Plan RSP P8*, Sacramento, CA, September 2006.
- Caltrans, 2006b. *Standard Plan P10*, Sacramento, CA, May 2006.
- Caltrans, 2006c. *Standard Plan P20*, Sacramento, CA, May 2006.
- Caltrans, 2007. *Caltrans SSP No. 40-020 Replace Concrete Pavement (Rapid Strength Concrete)*, Sacramento, CA, January 2007.
- Carmichael III, R. F., A. H. Meyer, L. L. Caldwell, and B. F. McCullough, 1989. *Rapid Replacement of Portland Cement Concrete Pavement Segments*, NCHRP Research Results Digest Number 169, Transportation Research Board, Washington, DC, 1989.
- Darter, M. I., E. J. Barenberg, and W. A. Yrjanson, 1985. *Joint Repair Methods for Portland Cement Concrete Pavements*, NCHRP Report 281, Transportation Research Board, Washington, DC, 1985.
- FHWA, 1985. *Pavement Rehabilitation Manual*, Report No. FHWA-ED-88-025, Federal Highway Administration, Washington, DC (Manual supplemented April 1986, July 1987, March 1988, February 1989, October 1990), 1985.
- FHWA, 2001. *PCC Pavement Evaluation and Rehabilitation*, NHI Course 131062, Federal Highway Administration, Washington, DC, October 2001.
- FHWA, 2004. *Pavement Preservation Design and Construction of Quality Preventive Maintenance Treatments*, NHI Course 131103, Federal Highway Administration, Washington, DC, November 2004.
- FHWA, 2005. *Full-Depth Repair of Portland Cement Concrete Pavements*, Pavement Preservation Checklist Series, Federal Highway Administration, Washington, DC, November 2005.
- NCHRP, 1977. *Rapid Setting Materials for Patching of Concrete*, NCHRP Synthesis of Highway Practice No. 45, National Cooperative Highway Research Program. Transportation Research Board, Washington, DC, 1977.
- Snyder, M. B., K. D. Smith, and M. I. Darter, 1989. *An Evaluation of Pressure Relief Joint Installations*, Transportation Research Record 1215, Transportation Research Board, Washington, DC, 1989.

## **APPENDIX A**

### **PAVEMENT PRESERVATION DEFINITIONS**

**(FHWA, SEPTEMBER 12, 2005)**



U.S. Department  
of Transportation  
**Federal Highway  
Administration**

# Memorandum

Subject: **ACTION**: Pavement Preservation Definitions

Date: September 12, 2005

*(Original Signed by David R. Geiger, P.E.)*

From: David R. Geiger, P.E.  
Director, Office of Asset Management

Reply to  
Attn. of: HIAM-20

To: Associate Administrators  
Directors of Field Services  
Resource Center Director and Operations Manager  
Division Administrators  
Federal Lands Highway Division Engineers

As a follow-up to our Preventive Maintenance memorandum of October 8, 2004, it has come to our attention that there are differences about how pavement preservation terminology is being interpreted among local and State transportation agencies (STAs). This can cause inconsistency relating to how the preservation programs are applied and their effectiveness measured. Based on those questions and a review of literature, we are issuing this guidance to provide clarification to pavement preservation definitions.

Pavement preservation represents a proactive approach in maintaining our existing highways. It enables STAs to reduce costly, time consuming rehabilitation and reconstruction projects and the associated traffic disruptions. With timely preservation we can provide the traveling public with improved safety and mobility, reduced congestion, and smoother, longer lasting pavements. This is the true goal of pavement preservation, a goal in which the FHWA, through its partnership with States, local agencies, industry organizations, and other interested stakeholders, is committed to achieve.

A Pavement Preservation program consists primarily of three components: preventive maintenance, minor rehabilitation (non structural), and some routine maintenance activities as seen in figure 1.

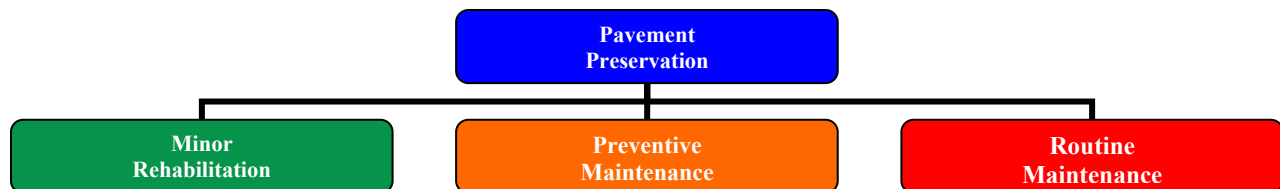

*Figure 1: Components of Pavement Preservation*



An effective pavement preservation program can benefit STAs by preserving investment on the NHS and other Federal-aid roadways, enhancing pavement performance, ensuring cost-effectiveness, extending pavement life, reducing user delays, and providing improved safety and mobility.

It is FHWA's goal to support the development and conduct of effective pavement preservation programs. As indicated above, pavement preservation is a combination of different strategies which, when taken together, achieve a single goal. It is useful to clarify the distinctions between the various types of maintenance activities, especially in the sense of why they would or would not be considered preservation.

For a treatment to be considered pavement preservation, one must consider its intended purpose. As shown in Table 1 below, the distinctive characteristics of pavement preservation activities are that they restore the function of the existing system and extend its service life, not increase its capacity or strength.

<b>Pavement Preservation Guidelines</b>					
	<b>Type of Activity</b>	<b>Increase Capacity</b>	<b>Increase Strength</b>	<b>Reduce Aging</b>	<b>Restore Serviceability</b>
	New Construction	X	X	X	X
	Reconstruction	X	X	X	X
	Major (Heavy) Rehabilitation		X	X	X
	Structural Overlay		X	X	X
	Minor (Light) Rehabilitation			X	X
<b>Pavement Preservation</b>	Preventive Maintenance			X	X
	Routine Maintenance				X
	Corrective (Reactive) Maintenance				X
	Catastrophic Maintenance				X

*Table 1- Pavement Preservation Guidelines*

### **Definitions for Pavement Maintenance Terminology**

**Pavement Preservation** is “a program employing a network level, long-term strategy that enhances pavement performance by using an integrated, cost-effective set of practices that extend pavement life, improve safety and meet motorist expectations.”

*Source: FHWA Pavement Preservation Expert Task Group*

An effective pavement preservation program will address pavements while they are still in good condition and before the onset of serious damage. By applying a cost-effective treatment at the

right time, the pavement is restored almost to its original condition. The cumulative effect of systematic, successive preservation treatments is to postpone costly rehabilitation and reconstruction. During the life of a pavement, the cumulative discount value of the series of pavement preservation treatments is substantially less than the discounted value of the more extensive, higher cost of reconstruction and generally more economical than the cost of major rehabilitation. Additionally, performing a series of successive pavement preservation treatments during the life of a pavement is less disruptive to uniform traffic flow than the long closures normally associated with reconstruction projects.

**Preventive Maintenance** is “a planned strategy of cost-effective treatments to an existing roadway system and its appurtenances that preserves the system, retards future deterioration, and maintains or improves the functional condition of the system (without significantly increasing the structural capacity).” *Source: AASHTO Standing Committee on Highways, 1997*

Preventive maintenance is typically applied to pavements in good condition having significant remaining service life. As a major component of pavement preservation, preventive maintenance is a strategy of extending the service life by applying cost-effective treatments to the surface or near-surface of structurally sound pavements. Examples of preventive treatments include asphalt crack sealing, chip sealing, slurry or micro-surfacing, thin and ultra-thin hot-mix asphalt overlay, concrete joint sealing, diamond grinding, dowel-bar retrofit, and isolated, partial and/or full-depth concrete repairs to restore functionality of the slab; e.g., edge spalls, or corner breaks.

**Pavement Rehabilitation** consists of “structural enhancements that extend the service life of an existing pavement and/or improve its load carrying capacity. Rehabilitation techniques include restoration treatments and structural overlays.” *Source: AASHTO Highway Subcommittee on Maintenance*

Rehabilitation projects extend the life of existing pavement structures either by restoring existing structural capacity through the elimination of age-related, environmental cracking of embrittled pavement surface or by increasing pavement thickness to strengthen existing pavement sections to accommodate existing or projected traffic loading conditions. Two sub-categories result from these distinctions, which are directly related to the restoration or increase of structural capacity.

*Minor rehabilitation* consists of non-structural enhancements made to the existing pavement sections to eliminate age-related, top-down surface cracking that develop in flexible pavements due to environmental exposure. Because of the non-structural nature of minor rehabilitation techniques, these types of rehabilitation techniques are placed in the category of pavement preservation.

*Major rehabilitation* “consists of structural enhancements that both extend the service life of an existing pavement and/or improve its load-carrying capability.” *Source: AASHTO Highway Subcommittee on Maintenance Definition*

**Routine Maintenance** “consists of work that is planned and performed on a routine basis to maintain and preserve the condition of the highway system or to respond to specific conditions and events that restore the highway system to an adequate level of service.” *Source: AASHTO Highway Subcommittee on Maintenance*

Routine maintenance consists of day-to-day activities that are scheduled by maintenance personnel to maintain and preserve the condition of the highway system at a satisfactory level of service. Examples of pavement-related routine maintenance activities include cleaning of roadside ditches and structures, maintenance of pavement markings and crack filling, pothole patching and isolated overlays. Crack filling is another routine maintenance activity which consists of placing a generally, bituminous material into “non-working” cracks to substantially reduce water infiltration and reinforce adjacent top-down cracks. Depending on the timing of application, the nature of the distress, and the type of activity, certain routine maintenance activities may be classified as preservation. Routine Maintenance activities are often “in-house” or agency-performed and are not normally eligible for Federal-aid funding.

Other activities in pavement repair are an important aspect of a STA’s construction and maintenance program, although they are outside the realm of pavement preservation:

**Corrective Maintenance** activities are performed in response to the development of a deficiency or deficiencies that negatively impact the safe, efficient operations of the facility and future integrity of the pavement section. Corrective maintenance activities are generally reactive, not proactive, and performed to restore a pavement to an acceptable level of service due to unforeseen conditions. Activities such as pothole repair, patching of localized pavement deterioration, e.g. edge failures and/or grade separations along the shoulders, are considered examples of corrective maintenance of flexible pavements. Examples for rigid pavements might consist of joint replacement or full width and depth slab replacement at isolated locations.

**Catastrophic Maintenance** describes work activities generally necessary to return a roadway facility back to a minimum level of service while a permanent restoration is being designed and scheduled. Examples of situations requiring catastrophic pavement maintenance activities include concrete pavement blow-ups, road washouts, avalanches, or rockslides.

**Pavement Reconstruction** is the replacement of the entire existing pavement structure by the placement of the equivalent or increased pavement structure. Reconstruction usually requires the complete removal and replacement of the existing pavement structure. Reconstruction may utilize either new or recycled materials incorporated into the materials used for the reconstruction of the complete pavement section. Reconstruction is required when a pavement has either failed or has become functionally obsolete.

If you need technical support or further guidance in the pavement preservation area, please contact Christopher Newman in the FHWA Office of Asset Management at (202) 366-2023 or via e-mail at [Christopher.Newman@fhwa.dot.gov](mailto:Christopher.Newman@fhwa.dot.gov).

FHWA:HIAM-20:LLAWNDY:63975:11:08/22/05

cc: Reader File: HIAM-1 C. Newman (HIAM-20) J. Sorenson (HIAM-20)

Disk File: W:\HIAM-20\Projects & Programs\Pavement Preservation\definition\Pavement  
Preservation Definitions Memo 081605.doc



## APPENDIX B

### GLOSSARY OF TERMS (Adopted from AASHTO)

**Adhesion** – Bond between a sealant material and the crack or joint sidewall or the bond between asphalt cement and aggregate.

**Agency Costs** – See Annual Costs.

**Aggregate Interlock** – The projection of aggregate particles or portions of aggregate particles from one side of a joint or crack in concrete into recesses in the other side of the joint or crack so as to affect load transfer in compression and shear and maintain mutual alignment.

**Analysis Period** – The period of time used in making economic comparisons between rehabilitation alternatives. The analysis period should not be confused with the pavement's design life (performance period).

**Annual Costs** – Any costs associated with the annual maintenance and repair of the facility.

**Application Temperature** – The manufacturer's recommended temperature to be used when installing sealant. For hot-applied sealants, the application temperature is any temperature between the minimum application temperature and safe heating temperature.

**Asset Management** – A systematic process of maintaining, upgrading, and operating physical assets cost-effectively. It combines engineering principles with sound business practices and economic theory, and it provides tools to facilitate a more organized, logical approach to decision-making. Thus, asset management provides a frame work for handling both short and long-range planning.

**Backer Material** – A compressible material that is placed in joints or cracks before applying sealant to prevent bonding of the sealant on the bottom of the joint, control sealant depth, and prevent sagging of the sealant.

**Bituminous Pavement** – A pavement comprising an upper layer or layers of aggregate mixed with a bituminous binder, such as asphalt, coal tars, and natural tars for purposes of this terminology; surface treatments such as chip seals, slurry seals, sand seals, and cape seals are also included.

**Blow-up** – Buckling and shattering of PCC pavement resulting from thermal expansion and the resultant compressive forces exceeding the strength of the material.

**Bond Breaker** – Any material used to prevent bonding or to separate adjacent pavement layers. Thin bituminous layers are often used as bond breaker layers between a concrete pavement and an unbonded concrete overlay.

**Bonded Concrete Overlay** – Increase in the pavement structure of a concrete pavement by addition of

concrete thickness in direct contact with and adhering to the existing concrete surface. May be used to correct either functional or structural deficiencies.

**California Profilograph** – Rolling straight edge tool used for evaluating pavement profile (smoothness) consisting of a 7.5m (25-ft) frame with a sensing wheel located at the center of the frame that senses and records bumps and dips on graph paper or in a computer.

**Carbide Milling** – Surface removal or sawing done with a carbide milling machine. Machine uses a blade or arbor equipped with carbide-tipped teeth that impact and chip concrete or asphalt.

**Chemically Curing Sealant** – A material that reaches its final properties through the reaction of the component materials when mixed.

**Cohesion** – The internal bond within a joint sealant material. Cohesion loss is seen as a noticeable tear along the surface and through the depth of the sealant.

**Cold Applied Sealant** – A crack-sealing compound that is applied in an unheated state (generally at ambient temperature) and then reaches final properties through a curing process.

**Compressible Insert** – Material used to separate freshly placed concrete (such as from a partial-depth or full-depth repair) from existing hardened concrete. This usually consists of a 12-mm (0.5 in) thick Styrofoam or compressed fiber material that is impregnated with asphalt.

**Concrete** – See Portland Cement Concrete

**Construction Joint** – A joint constructed in a transverse direction in PCC pavements to control cracking of the slab as it cures. Highway construction joints are created by sawing the concrete.

**Continuously Reinforced Concrete Pavement (CRCP)** – PCC pavement constructed with sufficient longitudinal steel reinforcement to control transverse crack spacings and openings in lieu of transverse contraction joints for accommodating concrete volume changes and load transfer.

**Corner Break** – A portion of a concrete slab separated by a crack that intersects the adjacent transverse or longitudinal joints at about a 45° angle with the direction of traffic. The length of the sides is usually from 0.3 meters (1 ft) to one-half of the slab width on each side of the crack.

**Corrective Maintenance** – Maintenance performed once a deficiency occurs in the pavement; e.g., pothole filling, or spall repair.

**CPR (Concrete Pavement Restoration)** – A series of repair techniques used to preserve or improve the structural capacity or functional characteristics of a PCC pavement. CPR techniques each have a unique purpose to repair or replace a particular distress (kind of deterioration) found in PCC pavement and to manage the rate of deterioration. CPR

techniques include:

- Full-depth repair
- Partial-depth repair
- Diamond grinding
- Joint and crack resealing
- Slab stabilization
- Dowel Bar Retrofit
- Cross-stitching cracks or longitudinal joints
- Retrofitting concrete shoulders
- Retrofitting edge drains

**Crack** – Fissure or discontinuity of the pavement surface not necessarily extending through the entire thickness of the pavement. Cracks generally develop after initial construction of the pavement and may be caused by thermal effects, excess loadings, or excess deflections.

**Crack Filling** – The placement of materials into non-working cracks to substantially reduce the intrusion of incompressibles and infiltration of water, while also reinforcing the adjacent pavement. Crack filling should be distinguished from crack sealing (see below).

**Crack Sealing** – A maintenance procedure that involves placement of specialized materials into working cracks using unique configurations to reduce the intrusion of incompressibles into the crack and to prevent infiltration of water into the underlying pavement layers. (See Working Crack.)

**Cross Stitching** – A repair method that involves the drilling of holes diagonally across a crack in PCC pavement into which steel reinforcement bars are inserted and epoxied in place. The holes are alternated from side to side of the crack on a pre-determined spacing. This technique is generally used for longitudinal cracks that are still in no worse than fair condition. Cross-stitching increases slab integrity by adding steel reinforcement to hold the crack together.

**Cure** – A period of time following placement and finishing of a material such as concrete during which desirable engineering properties (such as strength) develop. Improved properties may be achieved by controlling temperature or humidity during curing.

**Curing** – The maintenance of a satisfactory moisture content and temperature in concrete during its early stages so that desired properties may develop.

**Curing Blanket** – A built-up covering of burlap sacks, matting, straw, waterproof paper, or other suitable material placed over freshly finished concrete.

**Curing Compound** – A liquid that can be applied as a coating to the surface of newly placed concrete to retard the loss of water, or in the case of pigmented compounds, also to reflect heat so as to provide an opportunity for the concrete to develop its properties in a favorable temperature and moisture environment. See also Curing.

**Depression** – Localized pavement surface areas at a lower elevation than the adjacent paved

areas.

**Design Life** – The expected life of a pavement from its opening to traffic until structural rehabilitation is needed. The typical reporting of pavement design life does not include the life of the pavement with the application of preventive maintenance. (See also Analysis Period and Performance Period.)

**Diamond Grinding** – A process that uses a series of diamond-tipped saw blades mounted on a shaft or arbor to shave the upper surface of a pavement to remove bumps, restore pavement rideability, and improve surface friction. (See also CPR)

**Discount Rate** – The rate of interest reflecting the investor's time value of money used to determine discount factors for converting benefits and costs occurring at different times to a baseline date. Discount rates can incorporate an inflation rate depending on whether real discount rates or nominal discount rates are used. The discount rate is often approximated as the difference between the interest rate and the inflation rate.

**Dowel** – Most commonly a plain round steel bar (usually coated, such as with paint or epoxy), which extends into two adjoining slabs of a PCC pavement at a transverse joint placed parallel to the center line so as to transfer shear loads.

**Dowel Bar Retrofit** – A rehabilitation technique that is used to increase the load transfer capability of existing jointed PCC pavements by placement of dowel bars across joints and/or cracks that exhibit poor load transfer. (See also CPR)

**Equivalent Uniform Annual Cost (EUAC)** – The net present value of all discounted cost and benefits of an alternative as if they were to occur uniformly throughout the analysis period. Net Present Value (NPV) is the discounted monetary value of expected benefits (i.e., benefits minus costs).

**Faulting** – Differential vertical displacement of a slab or other member adjacent to a joint or crack. Faulting commonly occurs at transverse joints of PCC pavements that do not have adequate load transfer.

**Free Edge** – An unrestrained pavement boundary.

**Fuel Resistant Sealant** – A joint or crack sealant compound that is resistant to and maintains serviceability after being exposed to fuel or other petroleum products.

**Full-Depth Patching** – Removal and replacement of a segment of pavement to the level of the subgrade in order to restore areas of deterioration. May be either flexible or rigid pavement.

**Functional Performance** – A pavement's ability to provide a safe, smooth riding surface. These attributes are typically measured in terms of ride quality (see International Roughness Index) or skid resistance (see International Friction Index).

**Grinding Head** – Arbor or shaft containing numerous diamond blades or carbide teeth on diamond grinding or cold milling equipment.

**Grooving** – The process used to cut slots into a pavement surface (usually, although not always, PCC) to provide channels for water to escape beneath tires, improving skid resistance and reducing the potential for hydroplaning.

**Hot Applied Sealant** – A crack or joint sealing compound that is applied in a molten state and cures primarily by cooling to ambient temperature.

**Hot Mix Asphalt Concrete (HMAC or HMA)** – A thoroughly controlled mixture of asphalt binder and well-graded, high quality aggregate thoroughly compacted into a uniform dense mass. HMAC pavements may also contain additives such as anti-stripping agents and polymers.

**Hydroplaning** – Loss of contact between vehicle tires and roadway surface that occurs when vehicles travel at high speeds on pavement surfaces with standing water.

**Initial Costs** – All costs associated with the initial design and construction of a facility, placement of a treatment, or any other activity with a cost component.

**International Friction Index (IFI)** – A measure of pavement macrotexture and wet pavement friction at 60 miles per hour determined using measured friction at some test speed and macrotexture determined using ASTM E-965 or ASTM E-1845.

**International Roughness Index (IRI)** – A measure of a pavement's longitudinal surface profile as measured in the wheelpath by a vehicle traveling at typical operating speeds. It is calculated as the ratio of the accumulated suspension motion to the distance traveled obtained from a mathematical model of a standard quarter car traversing a measured profile at a speed of 80 km/h (50 mph). The IRI is expressed in units of meters per kilometer (inches per mile) and is a representation of pavement roughness.

**Joint** – A pavement discontinuity made necessary by design or by interruption of a paving operation.

**Joint Depth** – The measurement of a saw cut from the top of the pavement surface to the bottom of the cut.

**Joint Deterioration** – See Spalling.

**Joint Filler** – Compressible material used to fill a joint to prevent the infiltration of debris.

**Joint Sealant** – Compressible material used to minimize water and solid debris infiltration into the sealant reservoir and joint.

**Joint Seal Deterioration** - Break down of a joint or crack sealant, such as by adhesion or cohesion loss, which contributes to the failure of the sealant system. Joint seal

deterioration permits incompressible materials or water to infiltrate into the pavement system.

**Joint Shape Factor** – Ratio of the vertical to horizontal dimension of the joint sealant. Factor can vary depending on type of sealant specified.

**Jointed Plain Concrete Pavement (JPCP)** – PCC pavement constructed with regularly spaced transverse joints to control all natural cracks expected in the concrete. Dowel bars may be used to enhance load transfer at transverse contraction joints (depending upon the expected traffic); however, there is no mid-slab temperature reinforcement.

**Jointed Reinforced Concrete Pavement (JRCP)** – Portland cement concrete pavement containing regularly spaced transverse joints and embedded steel mesh reinforcement (sometimes called distributed steel) to control expected cracks. Steel mesh is discontinued at transverse joint locations. Dowel bars are normally used to enhance load transfer at transverse joints. The transverse joint spacing of JRCP is typically longer than the joint spacing of JPCP.

**Lane-to-Shoulder Dropoff** – (highways, roads and streets only) Difference in elevation between the traveled surface and the shoulder surface.

**Life Cycle Costing** – An economic assessment of an item, system, or facility and competing design alternatives considering all significant costs of ownership over the economic life, expressed in terms of equivalent dollars.

**Life Extension** – The extension of the performance period of the pavement through the application of pavement treatments.

**Load-Transfer Assembly** – Most commonly, the basket or carriage designed to support or link dowel bars in the desired alignment during jointed PCC pavement construction.

**Load Transfer Efficiency** – A measure of the ability of a joint or crack to transfer a portion of a load applied on one side of a joint or crack to the other side of the joint or crack.

**Longitudinal Crack** – A crack or discontinuity in a pavement that runs generally parallel to the pavement centerline. Longitudinal cracks may occur as a result of poorly constructed paving lane joints, thermal shrinkage, inadequate support, reflection from underlying layers, or as a precursor to fatigue cracking.

**Longitudinal Joint** – A constructed joint in a pavement layer that is oriented parallel to the pavement centerline.

**Low Modulus Sealant** – A joint or crack sealing material, which is less stiff at low temperatures than standard grade sealants.

**Maximum Heating Temperature** – The maximum temperature, as recommended by the manufacturer, to which a hot-applied joint or crack sealant can be heated while

conforming to all specification requirements and result in appropriate application characteristics.

**Melter** – A piece of equipment designed specifically to heat hot applied joint or crack sealant accurately and controllably to a temperature where it will flow.

**Melter Applicator** – A piece of equipment designed specifically to melt, heat accurately and controllably, and apply hot-applied sealants to pavement cracks or joints.

**Mineral Filler** – A finely divided mineral product with at least 70% passing the No. 200 sieve. Commonly used mineral fillers include, limestone dust, hydrated lime, portland cement, and fly ash.

**Minimum Application Temperature** – The minimum temperature, as recommended by the manufacturer, to which a hot-applied sealant for pavement cracks or joints must be heated while conforming to all specification requirements and result in appropriate application characteristics.

**Net Present Value** – The value of future expenditures or costs discounted to today's dollars using an appropriate discount rate.

**Overbanding** – Overfilling of a joint or crack reservoir so that a thin layer of crack or joint sealant is spread onto the pavement surface center over the joint or crack.

**Partial-Depth Patching** – Repairs of localized areas of surface deterioration of PCC pavements, usually for compression spalling problems, severe scaling, or other surface problems that are within the upper one-third of the slab depth.

**Patch** – Placement of a repair material to replace a localized defect in the pavement surface.

**Pavement Distress** – External (visible) indications of pavement defects or deterioration.

**Pavement Preservation** – The sum of all activities undertaken to provide and maintain serviceable roadways. This includes corrective maintenance and preventive maintenance, as well as minor rehabilitation projects.

**Pavement Preventive Maintenance** – Planned strategy of cost-effective treatments to an existing roadway system and its appurtenances that preserves the system, retards future deterioration, and maintains or improves the functional condition of the system (without increasing the structural capacity).

**Pavement Reconstruction** – Replacement of an existing pavement structure by the placement of the equivalent of a new pavement structure. Reconstruction usually involves complete removal and replacement of the existing pavement structure and may include new and/or recycled materials.

**Pavement Rehabilitation** – Structural enhancements that extend the service life of an existing pavement and/or improve its load carrying capability. Rehabilitation techniques include restoration treatments and structural overlays.

**Performance Period** – The period of time that an initially constructed or rehabilitated pavement structure will perform before reaching its terminal serviceability.

**Point Bearing** – Concentration of compressive stressed between small areas. May occur when a partial-depth patch in portland cement concrete pavement is made without the compressible insert. Also, slab expansion in hot weather forces an adjacent slab to bear directly against a small partial-dept patch and causes the patch to fail by delaminating and popping out of place.

**Polishing** – Wearing away of the surface binder, causing exposure of the coarse aggregate particles. A polished pavement surface is smooth and has reduced skid resistance.

**Portland Cement Concrete Pavement (PCC)** – A pavement constructed of portland cement concrete with or without reinforcement. Conventional PCC pavements include JPCP, JRCP, and CRCP.

**Preformed Compression Sealant** – An extruded joint sealing material for PCC pavement that is manufactured ready for installation and is supplied in rolls. Preformed sealants incorporate an internal web design so that the material, when compressed and inserted into the sealant reservoir, remains in compression against the sides of the joint.

**Present Serviceability Index (PSI)** – A subjective rating of the pavement condition made by a group of individuals riding over the pavement. May also be determined based on condition survey information.

**Present Worth** – See Net Present Value.

**Pumping** – Ejection of fine-grained material and water from beneath the pavement through joints, cracks, or the pavement edge, caused by the deflection of the pavement under traffic loadings.

**Reactive Maintenance** – Maintenance applied to restore a pavement to an acceptable level of service due to unforeseen conditions. Activities, such as pothole repairs, performed to correct random or isolated localized pavement distresses or failures, are considered reactive. Similar to Corrective Maintenance.

**Reflection Cracking** – Cracking that appears on the surface of a pavement above joints and cracks in the underlying pavement layer due to horizontal and vertical movement of these joints and cracks.

**Reservoir** – The part of a portland cement concrete pavement joint that normally holds a sealant material, usually formed by a widening saw cut above the initial saw cut. Reservoirs may also be found in HMA pavements where joints are sawed and sealed above existing PCC pavements.



- Retrofit Dowel Bars** – Dowels that are installed into slots cut into the surface of an existing concrete pavement to restore load transfer.
- Rideability** – A measure of the ride quality of a pavement as perceived by its users or roughness measuring equipment.
- Router** – A mechanical device, with a rotary cutting system, that is used to widen, cut, and clean cracks in pavements prior to sealing.
- Routine Maintenance** – Maintenance work that is planned and performed on a routine basis to maintain and preserve the condition of the highway system or to respond to specific conditions and events that restore the highway system to an adequate level of service. Examples include crack sealing, fog sealing, and repair of localized failed areas of pavement.
- Rubberized Asphalt Sealant** – A sealant, generally hot applied, that is composed of asphalt cement, various types of rubber or polymer modifiers, and other compounding ingredients used for pavement crack and joint sealing. Many grades and ranges of properties are available.
- Sandblasting** – A procedure in which sand particles are blown with compressed air at a pavement surface to abrade and clean the surface. Sandblasting is a construction step in partial-depth patching and joint resealing.
- Sealant** – A material that has adhesive and cohesive properties to seal joints, cracks, or other various openings against the entrance or passage of water or other debris in pavements (generally less than 76 mm (3 in) in width).
- Sealant Reservoir** – See Reservoir.
- Sealing** – The process of placing sealant material in prepared joints or cracks to minimize intrusion of water and incompressible materials. This term is also used to describe the application of pavement surface treatments.
- Sealing Compound** – See Joint Sealant.
- Segregation** – Separation of aggregate component of asphaltic or portland cement by particle size during placement.
- Serviceability** – Ability of a pavement to provide a safe and comfortable ride to its users. As such, it is primarily a measure of the functional capacity of the pavement.
- Settlement** – A depression at the pavement surface that is caused by the settling or erosion of one or more underlying layers.

**Silicone Sealant** – A type of joint or crack sealant compound either self leveling or non-sag in application characteristics that is based on polymers of polysiloxane structures and cures through a chemical reaction when exposed to air.

**Skid Resistance** – A measure of the frictional characteristics of a surface.

**Slab Stabilization** – Process of injecting grout or bituminous materials beneath PCC pavements in order to fill voids without raising the pavement.

**Spalling, Compression** – Cracking, breaking, chipping, or fraying of slab edges within 0.6 meters (2-ft) of a transverse crack.

**Spalling, Sliver** – Chipping of concrete edge along a joint sealant usually within 12 mm (0.5in) of the joint edge.

**Spalling, Surface** – Cracking, breaking, chipping, or fraying of slab surface, usually within a confined area less than 0.5 square meters (0.6 sy).

**Structural Condition** – The condition of a pavement as it pertains to its ability to support repeated traffic loadings.

**Structural Overlay** – An increase in the pavement load carrying capacity by adding additional pavement layers.

**Surface Texture** – The microscopic and macroscopic characteristics of the pavement surface that contribute to surface friction and noise.

**Swell** - A hump in the pavement surface that may occur over a small area or as a longer, gradual wave; either type of swell can be accompanied by surface cracking.

**Terminal Serviceability** – The lowest acceptable serviceability rating before resurfacing or reconstruction becomes necessary for the particular class of highway.

**Transverse Crack** – A discontinuity in a pavement surface that runs generally perpendicular to the pavement centerline. In HMA pavements, transverse cracks often form as a result of thermal movements of the pavement or reflection from underlying layers. In PCC pavements, transverse cracks may be caused by fatigue, loss of support, or thermal movements.

**Treatment Life** – The period of time during which a treatment application remains effective. Treatment life is contrasted with Life Extension.

**Two Component Sealant** – A sealant supplied in two components which must be mixed at a specified ratio prior to application in order to cure to final properties.

**Unbonded Overlay** – Increase in the pavement structure of an existing concrete or composite pavement by addition of jointed plain, jointed reinforced or continuously reinforced

concrete pavement placed on a separator layer (usually an asphalt layer) designed to prevent bonding to the existing pavement.

**User Costs** – Costs incurred by highway users traveling on the facility, and the excess costs incurred by those who cannot use the facility because of either agency or self-imposed detour requirements. User costs typically are comprised of vehicle operating costs (VOC), crash costs, and user delay costs. To be differentiated from agency costs.

**Warranty** – Contractual agreement between an approved contractor/vendor and the agency soliciting bids, that uses specific performance measures to protect the agency from responsibility of repair due to premature defects in material and/or workmanship.

**Waterblasting** – The use of a high-pressure water stream (8500 to 10,000 psi) to clean PCC. It may be used in PCC joint resealing to remove sawing laitance or in patching to produce a clean surface prior to placement of the sealer or patch material. Also referred to as hydroblasting.

**Working Crack** – A crack in a pavement that undergoes significant deflection and thermal opening and closing movements greater than 2 mm (1/16 in), typically oriented transverse to the pavement centerline.

## APPENDIX C

### LIST OF ACRONYMS

Acronyms	Description
AASHTO	American Association of Highway and Transportation Officials
ACPA	American Concrete Pavement Association
ACR	Alkali-carbonate reaction
ADT	Average daily traffic
ASR	Alkali-silica reaction
ASTM	American Standards for Testing and Materials
Caltrans	California Department of Transportation
CPR	Concrete pavement restoration
CPX	Close-Proximity method
CRCP	Continuously reinforced concrete pavement
CTM	California Test Methods
CTMeter	Circular Texture Meter
DBR	Dowel bar retrofit
DOT	Department of Transportation
ESAL	Equivalent single axle loads
EUAC	Equivalent uniform annual cost
FHWA	Federal Highway Administration
FP2	Foundation for Pavement Preservation
FWD	Falling weight deflectometer
HMA	Hot-mix asphalt
HMWM	High-molecular-weight methacrylate
IGGA	International Grooving and Grinding Association
IRI	International Roughness Index
ISO	International Standards Organization
JPCP	Jointed plan concrete pavements
JRCP	Jointed Reinforced Concrete Pavement
LCCA	Life cycle cost analysis
LISA	Lightweight Inertial Surface Analyzer
LTE	Load Transfer Efficiency
MLP	Multi-Laser Profiler
MnDOT	Minnesota Department of Transportation
MPD	Mean Profile Depth
MSDS	Material safety data sheets
MTAG	Maintenance Technical Advisory Guide
MTD	Mean Texture Depth
NCHRP	National Cooperative Highway Research Program
NCPP	National Center for Pavement Preservation
NDT	Non destructive testing
NHI	National Highway Institute
OFT	Outflow time
PCA	Portland Cement Association
PCC	Portland cement concrete

Acronyms	Description
PM	Preventive Maintenance
PSR	Pavement Serviceability Rating
PV	Present value
PVC	Poly-vinyl chloride
ROSAN	Road Surface Analyzer
RTRRMS	Response-type road roughness measuring systems
SHRP	Strategic Highway Research Program
SI	International System of units or Metric System
SI	Sound intensity method
SPB	Statistical Pass-By method
SSD	Saturated surface dry
SSPs	Standard Special Provisions
STAs	State transportation agencies
TI	Traffic index
TRB	Transportation Research Board

## APPENDIX D

### USEFUL WEBSITES

Source	Web Link
AASHTO Lead States Program	<a href="http://leadstates.transportation.org/pp/research_protocols.stm">http://leadstates.transportation.org/pp/research_protocols.stm</a>
ACPA	<a href="http://www.pavement.com/">http://www.pavement.com/</a>
Caltrans	<a href="http://www.dot.ca.gov/hq/esc/oe/specifications/std_specs/2006_StdSpecs/">http://www.dot.ca.gov/hq/esc/oe/specifications/std_specs/2006_StdSpecs/</a> <a href="http://www.dot.ca.gov/hq/maint/PavePres/ppindex.htm">http://www.dot.ca.gov/hq/maint/PavePres/ppindex.htm</a> <a href="http://www.dot.ca.gov/hq/oppd/pavement/guidance.htm">http://www.dot.ca.gov/hq/oppd/pavement/guidance.htm</a> <a href="http://www.dot.ca.gov/hq/esc/approved_products_list/">http://www.dot.ca.gov/hq/esc/approved_products_list/</a>
FHWA	<a href="http://www.fhwa.dot.gov/pavement/pub_listing.cfm?areas=Concrete">http://www.fhwa.dot.gov/pavement/pub_listing.cfm?areas=Concrete</a> <a href="http://www.fhwa.dot.gov/pavement/pres.cfm">http://www.fhwa.dot.gov/pavement/pres.cfm</a> <a href="http://www.fhwa.dot.gov/pavement/preservation/ppcl00.cfm">http://www.fhwa.dot.gov/pavement/preservation/ppcl00.cfm</a>
Foundation for Pavement Preservation	<a href="http://www.fp2.org/">http://www.fp2.org/</a>
NCPP	<a href="http://www.pavementpreservation.org/library/libraryindex.php">http://www.pavementpreservation.org/library/libraryindex.php</a>
PCA	<a href="http://www.cement.org/">http://www.cement.org/</a>
UC Berkeley, Institute of Transportation Studies	<a href="http://www.techtransfer.berkeley.edu/pavementpres/#prelim">http://www.techtransfer.berkeley.edu/pavementpres/#prelim</a>

**APPENDIX E\***

**CALIFORNIA DEPARTMENT OF TRANSPORTATION  
Surface Treatment  
Review Checklist and Evaluation**

District \_\_\_\_ Project EA \_\_\_\_\_ Work Type Code \_\_\_\_

Program  HA  HM  Warranty

Type of Review:  General Review  Test Site Review  District Request

Other \_\_\_\_\_

Review Requested By District: \_\_\_\_\_

Review Requested By Person: \_\_\_\_\_

Surface Treatment Type: \_\_\_\_\_

Project Location: County \_\_\_\_\_ Rte \_\_\_\_\_ PM From \_\_\_\_\_ PM TO \_\_\_\_\_

Description: Route Class #  ADT  % Truck  IRI

Reason for Use of Surface Treatment:  PM  CM  CAPM  REHAB

Pre-Construction Review  Follow Up 1  Follow Up 2  Follow Up 3

Date of Review: \_\_\_\_\_

Reviewers: \_\_\_\_\_

\_\_\_\_\_  
\_\_\_\_\_  
\_\_\_\_\_

\* Example only. This is for asphalt concrete pavements

# Drive through Checklist

**Note specific areas to review :**                      **By GPS OR Post Mile**

Sample Site #1 \_\_\_\_\_ Sample Site #2 \_\_\_\_\_

Sample Site #3 \_\_\_\_\_ Over View \_\_\_\_\_

<b>Scoring System:</b>	<b>Very Poor</b> 1-3	<b>Poor</b> 4-6	<b>Acceptable</b> 7	<b>Good</b> 8-9	<b>Excellent</b> 10
------------------------	-------------------------	--------------------	------------------------	--------------------	------------------------

## 1. OVERVIEW AND RIDE QUALITY

**Overview of Project:**      1   2   3   4   5   6   7   8   9   10  
 (Overall impression of project based on drive-through, windshield inspection)

**Rideability:**                      1   2   3   4   5   6   7   8   9   10  
 (Smoothness)

**Appearance:**                      1   2   3   4   5   6   7   8   9   10  
 (Consistent surface texture and/or color, blemishes, fattiness/flushing, raveling)

**Laydown:**                              1   2   3   4   5   6   7   8   9   10  
 (Joints, Edges, overlaps, starts and finishes, corrugations)

**Misc. Surface Conditions:** 1   2   3   4   5   6   7   8   9   10  
 (Spillage, consistency, loose aggregate, discarded materials, pickup and carry over)

**Method of Review:**                      Review outside lane – Make a note of any problems in the inside lanes if different from condition of outside lane.

---



---



---



**EVALUATION**

<b>Scoring System:</b>	<b>Very Poor</b> 1-3	<b>Poor</b> 4-6	<b>Acceptable</b> 7	<b>Good</b> 8-9	<b>Excellent</b> 10
------------------------	-------------------------	--------------------	------------------------	--------------------	------------------------

**Cracking:**

**Rt Lane Up Station**

**Rt Lane Down Station**

	<u>Rt Lane Up Station</u>							<u>Rt Lane Down Station</u>							
	Type	Size	LT	RT	Pumping	L ong or Trans	Size	Type	Size	Lt Wheel Tract	RT Wheel Tract	Pumping	Long or Trans	Size	
	A or B	Hairline <1/4, > 1/4, < 1/2, > 1/2,						A or B	Hairline <1/4,>1/4 <1/2,>1/2						
SS #1	<input type="text"/>	<input type="text"/>	<input type="text"/>	<input type="text"/>	<input type="text"/>	<input type="text"/>	<input type="text"/>	<input type="text"/>	<input type="text"/>	<input type="text"/>	<input type="text"/>	<input type="text"/>	<input type="text"/>	<input type="text"/>	<input type="text"/>
SS #2	<input type="text"/>	<input type="text"/>	<input type="text"/>	<input type="text"/>	<input type="text"/>	<input type="text"/>	<input type="text"/>	<input type="text"/>	<input type="text"/>	<input type="text"/>	<input type="text"/>	<input type="text"/>	<input type="text"/>	<input type="text"/>	<input type="text"/>
SS #3	<input type="text"/>	<input type="text"/>	<input type="text"/>	<input type="text"/>	<input type="text"/>	<input type="text"/>	<input type="text"/>	<input type="text"/>	<input type="text"/>	<input type="text"/>	<input type="text"/>	<input type="text"/>	<input type="text"/>	<input type="text"/>	<input type="text"/>
OV	<input type="text"/>	<input type="text"/>	<input type="text"/>	<input type="text"/>	<input type="text"/>	<input type="text"/>	<input type="text"/>	<input type="text"/>	<input type="text"/>	<input type="text"/>	<input type="text"/>	<input type="text"/>	<input type="text"/>	<input type="text"/>	<input type="text"/>

Total Score:

SS#1 Comments

---



---

SS#2 Comments

---



---

SS#3 Comments

---



---

Over View Comments

---



---

**EVALUATION**

<b>Scoring System:</b>	<b>Very Poor</b> 1-3	<b>Poor</b> 4-6	<b>Acceptable</b> 7	<b>Good</b> 8-9	<b>Excellent</b> 10
------------------------	-------------------------	--------------------	------------------------	--------------------	------------------------

**Rutting**

**Rt Lane Up Station**

**Rt Lane Down Station**

**Lt**  
**Whl Depth Length**

**Rt**  
**Whl Depth Length**

**Lt**  
**Whl Depth Length**

**Rt**  
**Whl Depth Length**

**SS#1**

<input type="text"/>	<input type="text"/>	<input type="text"/>	<input type="text"/>	<input type="text"/>	<input type="text"/>
----------------------	----------------------	----------------------	----------------------	----------------------	----------------------

<input type="text"/>	<input type="text"/>	<input type="text"/>	<input type="text"/>	<input type="text"/>	<input type="text"/>
----------------------	----------------------	----------------------	----------------------	----------------------	----------------------

<input type="text"/>	<input type="text"/>	<input type="text"/>	<input type="text"/>	<input type="text"/>	<input type="text"/>
----------------------	----------------------	----------------------	----------------------	----------------------	----------------------

<input type="text"/>	<input type="text"/>	<input type="text"/>	<input type="text"/>	<input type="text"/>	<input type="text"/>
----------------------	----------------------	----------------------	----------------------	----------------------	----------------------

**SS#3**

<input type="text"/>	<input type="text"/>	<input type="text"/>	<input type="text"/>	<input type="text"/>	<input type="text"/>
----------------------	----------------------	----------------------	----------------------	----------------------	----------------------

<input type="text"/>	<input type="text"/>	<input type="text"/>	<input type="text"/>	<input type="text"/>	<input type="text"/>
----------------------	----------------------	----------------------	----------------------	----------------------	----------------------

**Over View**

<input type="text"/>	<input type="text"/>	<input type="text"/>	<input type="text"/>	<input type="text"/>	<input type="text"/>
----------------------	----------------------	----------------------	----------------------	----------------------	----------------------

<input type="text"/>	<input type="text"/>	<input type="text"/>	<input type="text"/>	<input type="text"/>	<input type="text"/>
----------------------	----------------------	----------------------	----------------------	----------------------	----------------------

**Rutting Score:**

SS#1 Comments

---



---

SS#2 Comments

---



---

SS#3 Comments

---



---

Over View Comments

---



---

**EVALUATION**

<b>Scoring System:</b>	<b>Very Poor 1-3</b>	<b>Poor 4-6</b>	<b>Acceptable 7</b>	<b>Good 8-9</b>	<b>Excellent 10</b>
------------------------	--------------------------	---------------------	-------------------------	---------------------	-------------------------

**Surface Texture:**

**Delamination / Potholes:**

	<u>Rt Lane Up Station</u>				<u>Rt Lane Down Station</u>			
	<b>Delam</b>	<b>% Of</b>	<b>Potholes</b>	<b>Number Of</b>	<b>Delam</b>	<b>% Of</b>	<b>Potholes</b>	<b>Number Of</b>
Sample Site #1	<input type="text"/>	<input type="text"/>	<input type="text"/>	<input type="text"/>	<input type="text"/>	<input type="text"/>	<input type="text"/>	<input type="text"/>
Sample Site #2	<input type="text"/>	<input type="text"/>	<input type="text"/>	<input type="text"/>	<input type="text"/>	<input type="text"/>	<input type="text"/>	<input type="text"/>
Sample Site #3	<input type="text"/>	<input type="text"/>	<input type="text"/>	<input type="text"/>	<input type="text"/>	<input type="text"/>	<input type="text"/>	<input type="text"/>
Over View	<input type="text"/>	<input type="text"/>	<input type="text"/>	<input type="text"/>	<input type="text"/>	<input type="text"/>	<input type="text"/>	<input type="text"/>

Total Score:

SS#1 Comments

---



---

SS#2 Comments

---



---

SS#3 Comments

---



---

Over View Comments

---



---

**EVALUATION**

<b>Scoring System:</b>	<b>Very Poor</b> 1-3	<b>Poor</b> 4-6	<b>Acceptable</b> 7	<b>Good</b> 8-9	<b>Excellent</b> 10
------------------------	-------------------------	--------------------	------------------------	--------------------	------------------------

**Flushing / Bleeding:**

**Rt Lane Up Station**

LT Whl Length RT Whl Length  
 F/B F/B

**Rt Lane Down Station**

LT Whl Length RT Whl Length  
 F/B F/B

Sample Site #1	<input type="text"/>	<input type="text"/>	<input type="text"/>	<input type="text"/>	<input type="text"/>	<input type="text"/>	<input type="text"/>	<input type="text"/>	<input type="text"/>
Sample Site #2	<input type="text"/>	<input type="text"/>	<input type="text"/>	<input type="text"/>	<input type="text"/>	<input type="text"/>	<input type="text"/>	<input type="text"/>	<input type="text"/>
Sample Site #3	<input type="text"/>	<input type="text"/>	<input type="text"/>	<input type="text"/>	<input type="text"/>	<input type="text"/>	<input type="text"/>	<input type="text"/>	<input type="text"/>
Over View	<input type="text"/>	<input type="text"/>	<input type="text"/>	<input type="text"/>	<input type="text"/>	<input type="text"/>	<input type="text"/>	<input type="text"/>	<input type="text"/>

Total Score:

Comments:

**Rich Area**

**Rt Lane Up Station**

Severity Number Length  
 L,M,H Of

**Rt Lane Down Station**

Severity Number Length  
 L M H Of

Sample Site #1	<input type="text"/>	<input type="text"/>	<input type="text"/>	<input type="text"/>	<input type="text"/>	<input type="text"/>	<input type="text"/>	<input type="text"/>
Sample Site #2	<input type="text"/>	<input type="text"/>	<input type="text"/>	<input type="text"/>	<input type="text"/>	<input type="text"/>	<input type="text"/>	<input type="text"/>
Sample Site #3	<input type="text"/>	<input type="text"/>	<input type="text"/>	<input type="text"/>	<input type="text"/>	<input type="text"/>	<input type="text"/>	<input type="text"/>
Over View	<input type="text"/>	<input type="text"/>	<input type="text"/>	<input type="text"/>	<input type="text"/>	<input type="text"/>	<input type="text"/>	<input type="text"/>

Rich Area Score

Comments:

**EVALUATION**

<b>Scoring System:</b>	<b>Very Poor</b> 1-3	<b>Poor</b> 4-6	<b>Acceptable</b> 7	<b>Good</b> 8-9	<b>Excellent</b> 10
------------------------	-------------------------	--------------------	------------------------	--------------------	------------------------

**Raveling (surface blemishes):**

**Rt Lane Up Station**

**Rt Lane Down Station**

**RT Lane**      **Severity**      **Length**  
 Yes / No      L,M,H

**RT Lane**      **Severity**      **Length**  
 Yes / No      L,M,H

Sample Site #1	<input type="checkbox"/>	<input type="checkbox"/>	<input type="checkbox"/>	<input type="checkbox"/>	<input type="checkbox"/>	<input type="checkbox"/>
Sample Site #2	<input type="checkbox"/>	<input type="checkbox"/>	<input type="checkbox"/>	<input type="checkbox"/>	<input type="checkbox"/>	<input type="checkbox"/>
Sample Site #3	<input type="checkbox"/>	<input type="checkbox"/>	<input type="checkbox"/>	<input type="checkbox"/>	<input type="checkbox"/>	<input type="checkbox"/>
Over View	<input type="checkbox"/>	<input type="checkbox"/>	<input type="checkbox"/>	<input type="checkbox"/>	<input type="checkbox"/>	<input type="checkbox"/>

Raveling Score

Comments \_\_\_\_\_

---

**Aggregate polishing or crushing:**

**Rt Lane down Station**

**Rt Lane Down Station**

**Type**      **Lt Whl**      **Rt Whl**      **Length**  
 P/C      Track      Track

**Type**      **LT Whl**      **RT Whl**      **Length**  
 P/C      Track      Track

Sample Site #1	<input type="checkbox"/>	<input type="checkbox"/>	<input type="checkbox"/>	<input type="checkbox"/>	<input type="checkbox"/>	<input type="checkbox"/>	<input type="checkbox"/>
Sample Site #2	<input type="checkbox"/>	<input type="checkbox"/>	<input type="checkbox"/>	<input type="checkbox"/>	<input type="checkbox"/>	<input type="checkbox"/>	<input type="checkbox"/>
Sample Site #3	<input type="checkbox"/>	<input type="checkbox"/>	<input type="checkbox"/>	<input type="checkbox"/>	<input type="checkbox"/>	<input type="checkbox"/>	<input type="checkbox"/>
Over View	<input type="checkbox"/>	<input type="checkbox"/>	<input type="checkbox"/>	<input type="checkbox"/>	<input type="checkbox"/>	<input type="checkbox"/>	<input type="checkbox"/>

AGG/ Polish Score

## 2. RAMPS, CONNECTORS & INTERSECTIONS

### EVALUATION

<b>Very Poor</b> 1-3	<b>Poor</b> 4-6	<b>Acceptable</b> 7	<b>Scoring System:</b>	<b>Good</b> 8-9	<b>Excellent</b> 10
-------------------------	--------------------	------------------------	------------------------	--------------------	------------------------

**Ramps:** 1 2 3 4 5 6 7 8 9 10

Cracking     Rutting     Bleeding     Raveling

Polishing     Crushing     Score

---



---



---

**Connectors:** 1 2 3 4 5 6 7 8 9 10

Cracking     Rutting     Bleeding     Raveling

Polishing     Crushing     Score

---



---



---

**Intersections:** 1 2 3 4 5 6 7 8 9 10

Cracking     Rutting     Bleeding     Raveling

Polishing     Crushing     Score

---



---



---

### EVALUATION

Performance  Exceeds  Meets  Fails      Final Score

**Final Comments:**

---

---

---

---

---

---

---

---

**Recommendations:**

---

---

---

---

---

---

---

**District Major Repairs**

	<b>Dig Outs</b>			<b>Overlays</b>			<b>Profile Grind</b>			<b>Seal Coats</b>		
	<b># Of Lanes</b>	<b>Lene Rep'd</b>	<b>Area Sq Yd</b>	<b># Of Lanes</b>	<b>Lene Rep'd</b>	<b>Area Sq Yd</b>	<b># Of Lanes</b>	<b>Lene Rep'd</b>	<b>Area Sq Yd</b>	<b># Of Lanes</b>	<b>Lene Rep'd</b>	<b>Area Sq Yd</b>
<b>SS#1</b>	<input type="text"/>	<input type="text"/>	<input type="text"/>	<input type="text"/>	<input type="text"/>	<input type="text"/>	<input type="text"/>	<input type="text"/>	<input type="text"/>	<input type="text"/>	<input type="text"/>	<input type="text"/>
<b>SS#2</b>	<input type="text"/>	<input type="text"/>	<input type="text"/>	<input type="text"/>	<input type="text"/>	<input type="text"/>	<input type="text"/>	<input type="text"/>	<input type="text"/>	<input type="text"/>	<input type="text"/>	<input type="text"/>
<b>SS#3</b>	<input type="text"/>	<input type="text"/>	<input type="text"/>	<input type="text"/>	<input type="text"/>	<input type="text"/>	<input type="text"/>	<input type="text"/>	<input type="text"/>	<input type="text"/>	<input type="text"/>	<input type="text"/>
<b>Over View</b>	<input type="text"/>	<input type="text"/>	<input type="text"/>	<input type="text"/>	<input type="text"/>	<input type="text"/>	<input type="text"/>	<input type="text"/>	<input type="text"/>	<input type="text"/>	<input type="text"/>	<input type="text"/>

SS#1 Comments

---

SS#2 Comments

---

SS#3 Comments

---

Over View Comments

---



**District Minor Repairs**

	<u>Crack Seal</u>			<u>Potholes</u>			<u>Skin patches</u>		
	Type Crack	Length L M	Type Material	Lane #	# Lanes	Potholes # of	Lane #	Type Of	Area Sq Yd
SS#1	<input type="text"/>	<input type="text"/>	<input type="text"/>	<input type="text"/>	<input type="text"/>	<input type="text"/>	<input type="text"/>	<input type="text"/>	<input type="text"/>
SS#2	<input type="text"/>	<input type="text"/>	<input type="text"/>	<input type="text"/>	<input type="text"/>	<input type="text"/>	<input type="text"/>	<input type="text"/>	<input type="text"/>
SS#3	<input type="text"/>	<input type="text"/>	<input type="text"/>	<input type="text"/>	<input type="text"/>	<input type="text"/>	<input type="text"/>	<input type="text"/>	<input type="text"/>
Over View	<input type="text"/>	<input type="text"/>	<input type="text"/>	<input type="text"/>	<input type="text"/>	<input type="text"/>	<input type="text"/>	<input type="text"/>	<input type="text"/>

SS#1 Comments

---

SS#2 Comments

---

SS#3 Comments

---

Over View Comments

---