



**PDHonline Course M304 (7 PDH)**

---

# **Fire Protection Fundamentals**

*Instructor: Steven G. Liescheidt, P.E., CCS, CCPR*

**2020**

**PDH Online | PDH Center**

5272 Meadow Estates Drive  
Fairfax, VA 22030-6658  
Phone: 703-988-0088  
[www.PDHonline.com](http://www.PDHonline.com)

An Approved Continuing Education Provider

# Fire Protection

## NIOSH Instructional Module



**SHAPE**

Safety/Health Awareness  
for Preventive Engineering



U.S. DEPARTMENT OF HEALTH AND HUMAN SERVICES

Public Health Service

Centers for Disease Control and Prevention

National Institute for Occupational Safety and Health

**CDC**  
CENTERS FOR DISEASE CONTROL  
AND PREVENTION



# **FIRE PROTECTION**

*Authors*

**James R. Mehaffey, Ph.D.**  
Associate Professor, Fire Protection Engineering  
Department of Chemical and Bio-Resource Engineering

*and*

**Joel L. Bert, Ph.D.**  
Professor, Department of Chemical and Bio-Resource Engineering  
University of British Columbia  
Vancouver, V6T 1Z4 Canada

**U.S. DEPARTMENT OF HEALTH AND HUMAN SERVICES**

Public Health Service  
Centers for Disease Control and Prevention  
National Institute for Occupational Safety and Health  
Division of Training and Manpower Development  
Cincinnati, Ohio  
May 1997

## ACKNOWLEDGEMENTS

We wish to thank the following personnel for their review of this document: John T. Talty, P.E., NIOSH, and Glen E. Gardner, OSHA.

This report was prepared in support of NIOSH Project SHAPE (Safety and Health Awareness for Preventive Engineering). Project SHAPE is designed to enhance the education of engineers in the safety and health field.

## DISCLAIMER

The opinions, findings, and conclusions expressed are not necessarily those of the National Institute for Occupational Safety and Health, nor does mention of company names or products constitute endorsement by the National Institute for Occupational Safety and Health.

*NIOSH Project Officer*

John T. Talty, P.E.

NIOSH Order No. 9637770

## CONTENTS

	Page
Abstract .....	V
<b>UNIT I - BACKGROUND</b>	
<i>Purpose; Objectives; Special Terms</i> .....	I-1
FIRE LOSS STATISTICS .....	I-2
REGULATORY FRAMEWORK .....	I-2
Building codes; Fire prevention codes .....	I-2
National Fire Protection Association; Occupational Safety and Health Administration; Testing laboratories; Consumer protection; Insurance carriers .....	I-3
FIRE PROTECTION ENGINEERING .....	I-3
ORGANIZATION OF MODULE .....	I-4
REFERENCES .....	I-5
<b>UNIT II - INTRODUCTION</b>	
<i>Purpose; Objectives; Special Terms</i> .....	II-1
FIRE SAFETY OBJECTIVES .....	II-2
FIRE HAZARDS .....	II-2
FIRE PERFORMANCE OF MATERIALS .....	II-3
<b>UNIT III - FUNDAMENTALS OF FIRE SCIENCE</b>	
<i>Purpose; Objectives; Special Terms</i> .....	III-1
INTRODUCTION .....	III-2
FIRE TETRAHEDRON .....	III-2
FIRE AS A CHEMICAL REACTION .....	III-3
TYPE OF FUEL .....	III-4
Vapor .....	III-4
Liquid .....	III-5
Solid .....	III-6
FLAMING COMBUSTION .....	III-7
Oxidant .....	III-9
IGNITION SOURCES .....	III-9
REFERENCES .....	III-10
SAMPLE QUIZ QUESTIONS .....	III-11
<b>UNIT IV - DYNAMICS OF FIRE</b>	
<i>Purpose; Objectives; Special Terms</i> .....	IV-1
INTRODUCTION .....	IV-2
HEAT TRANSFER IN FIRES .....	IV-2
Conductive heat transfer; Convective heat transfer .....	IV-2
Radiative heat transfer .....	IV-3
ROOM FIRE DYNAMICS .....	IV-4
PREFLASHOVER FIRES .....	IV-5
POSTFLASHOVER FIRES .....	IV-6
SMOKE PRODUCTION .....	IV-7
Smoke toxicity; Toxic fire gases .....	IV-8
Toxic potency .....	IV-9
REFERENCES .....	IV-9
SAMPLE QUIZ QUESTIONS .....	IV-10

## UNIT V - PRINCIPLES OF FIRE PROTECTION

<i>Purpose; Objectives; Special Terms</i> .....	V-1
INTRODUCTION .....	V-2
FIRE SAFETY CONCEPTS TREE .....	V-2
Fire safety objectives .....	V-2
Prevent fire ignition .....	V-3
Manage fire impact .....	V-4
THE PROVISION OF FIRE SAFETY .....	V-8
REFERENCES .....	V-8
SAMPLE QUIZ QUESTIONS .....	V-9

## UNIT VI - FIRE DETECTION

<i>Purpose; Objectives; Special Terms</i> .....	VI-1
INTRODUCTION .....	VI-2
FIRE ALARM SYSTEMS .....	VI-2
DETECTION DEVICES .....	VI-2
Fire signature .....	VI-2
Aerosol detectors .....	VI-3
Heat detectors .....	VI-4
Infrared and ultraviolet flame detectors .....	VI-7
Gas sensing detectors .....	VI-8
FIRE DETECTION SYSTEM CONCERNS .....	VI-9
Fire alarm system details .....	VI-9
REFERENCES .....	VI-9
SAMPLE QUIZ QUESTIONS .....	VI-9

## UNIT VII - FIRE SUPPRESSION

<i>Purpose; Objectives; Special Terms</i> .....	VII-1
INTRODUCTION .....	VII-2
THEORY OF SUPPRESSION .....	VII-2
Water .....	VII-2
Foams; Carbon dioxide .....	VII-3
Halon; Dry chemicals .....	VII-4
AUTOMATIC SUPPRESSION SYSTEMS .....	VII-4
Automatic water sprinkler systems .....	VII-4
Foam extinguishing systems .....	VII-5
Carbon dioxide systems; Halon extinguishing systems; Dry chemical systems .....	VII-6
SUPPRESSION BY THE FIRE SERVICES .....	VII-6
In-house fire brigades .....	VII-6
Public fire departments .....	VII-7
PORTABLE FIRE EXTINGUISHERS .....	VII-7
Water based extinguishers .....	VII-8
Foam extinguishers; Carbon dioxide extinguishers; Dry chemical extinguishers; Class D extinguishers .....	VII-9
REFERENCES .....	VII-10
SAMPLE QUIZ QUESTIONS .....	VII-10
GLOSSARY .....	VIII-1

## ABSTRACT

The objective of this educational module is to familiarize undergraduate engineering students with basic principles related to fire protection. This instructional module can be studied separately or as a component of an upper-level engineering course. The information in this module is appropriate for courses on occupational safety and health, and applied engineering chemistry. In addition, the module could serve as a complement to courses on fluid mechanics and heat transfer; strength of materials and structures; and design courses.

The module introduces basic fire protection issues related to the safeguarding of life and property against fire loss. It describes the fundamental principles of fire science and of the dynamics of fire growth in buildings and demonstrates how a sound understanding of these is necessary before viable fire protection measures can be implemented. The module develops an engineering appreciation of standard practices and regulations related to the prevention, detection and suppression of fires.

The primary thrust of the module is to describe current fire safety practices and regulations; however, a brief account is given of the emerging discipline of fire protection engineering. This new field is expected to foster engineered design solutions to fire safety problems which may be more cost-effective and flexible than standardized solutions.

As fire protection issues are often overlooked in undergraduate engineering programs, an effort has been made to identify what resources are available and where the student can get further information about this subject.





**Unit I**  
**BACKGROUND**

**PURPOSE:** To provide an overview of the losses that result from fire and the regulations that are adopted to prevent and abate this threat.

**OBJECTIVES:** To provide an overview of:

1. Fire loss statistics related to injury and death
2. Fire loss statistics related to property damage and business interruption
3. The regulatory framework intended to ensure fire safety
4. The organization of this module

**SPECIAL TERMS:**

1. Fire loss statistics
2. National Fire Protection Association (NFPA)
3. Occupational Safety and Health Administration (OSHA)
4. Building codes
5. Fire prevention codes
6. Fire standards
7. Fire performance
8. Prescriptive codes
9. Performance-based codes
10. Fire protection engineering

## **FIRE LOSS STATISTICS**

Fires extract a high toll in injuries and in loss of human life. In the United States, occupational fatalities account for more than 3% of all deaths related to fires<sup>1</sup>. This figure translates into about 40 deaths per year associated with industrial and manufacturing fires in addition to the approximately 750 injuries from these fires<sup>2</sup>.

Statistics generated by the National Fire Protection Association show that during the period 1988-1993 industrial and manufacturing fires accounted for annual property losses of about \$1.0 billion<sup>2</sup>. More recently, 1995 direct property losses due to all fires in the United States have been estimated to be nearly \$8 billion<sup>3</sup>. Although residential fires accounted for approximately 60% of these losses, industrial property damage was also high and estimated to be \$1.3 billion. This figure represents a significant increase from the previous year. Losses associated with storage in structures also increased dramatically in 1995 to more than \$700 million.

Although the causes of industrial and manufacturing fires are often difficult to determine, the major sources of ignition appear to be: manufacturing, electrical or heating equipment; open flames; and incendiary sources. Because of the diverse nature of the causes of industrial fires, protective measures must be carefully engineered for specific industrial processes and their hazards.

## **REGULATORY FRAMEWORK**

Although these fire statistics are significant, they represent an improvement in fire safety compared with past experience. Much of this improvement results from the regulatory framework that has been established to ensure that fire safety objectives are met throughout the United States. Although this regulatory framework is multi-layered and complex, the simplified picture that follows shows how it is structured and how it works.

### **Building codes**

Three private organizations have developed and maintain three model building codes in the United States: the International Conference of Building Officials (ICBO), the Southern Building Code Congress International (SBCCI), and the Building Officials and Code Administrators (BOCA). Among other functions, these codes provide a set of fire safety provisions intended to ensure that an acceptable level of life safety is incorporated into buildings at the time of their construction. The codes use fire safety standards developed by the National Fire Protection Association (NFPA) and the American Society for Testing and Materials (ASTM).

States and municipalities adopt one of these model codes to form the basis of local building regulations. Enforcement of these regulations is the responsibility of local (and sometimes State) building inspectors. As a consequence both the letter of the law and its enforcement may vary somewhat from place to place.

### **Fire prevention codes**

The NFPA has developed and maintains NFPA 1, a model fire prevention code<sup>4</sup>. The code offers provisions intended to ensure that, following construction, buildings are equipped, operated and maintained to provide an acceptable level of life safety and property protection from potential hazards created by fires or explosions. NFPA 1 makes reference to 97 other codes and standards developed by the NFPA to address various specific fire safety concerns.

State and local jurisdictions have adopted NFPA 1 as the basis of their fire prevention regulations. Again, enforcement of these regulations is the responsibility of local and State officials including fire service personnel.

**National Fire Protection Association**

The National Fire Protection Association (NFPA) is a nonprofit organization that develops and publishes codes and standards intended to minimize the occurrence and effects of fire in all aspects of contemporary activity. The more than 290 codes and standards of the NFPA are developed by committees comprised of expert volunteers from various backgrounds. Some of these codes and standards delineate standard practices for designing facilities, installing equipment or undertaking inspections. Others describe standardized methods for conducting fire tests on personal protective equipment, building products and fire protection equipment. These codes and standards are widely used as the basis of legislation and regulation at all levels of government, from local to Federal. Many are referenced by agencies of the Federal government, such as the Occupational Safety and Health Administration (OSHA). NFPA codes and standards are also used by insurance authorities for risk evaluation and premium rating.

**Occupational Safety and Health Administration**

The provision of workplace safety is the purview of the Occupational Safety and Health Administration (OSHA), an agency of the U.S. Department of Labor. OSHA has a mandate to provide workplace fire protection and explosion prevention standards and regulations to ensure safe working conditions. To achieve its mandate, OSHA generates its own standards and also often adopts standards developed by the NFPA.

**Testing laboratories**

The provision of fire safety relies heavily on NFPA standard fire tests. Several accredited testing laboratories are available to undertake such testing and, hence, to document the fire performance of personal protective equipment, building products, and fire protection equipment.

**Consumer protection**

Consumer protection departments of Federal and State governments are concerned with the fire performance of commercial products such as furnishings, which may not be regulated by building codes or fire prevention codes. These departments have implemented programs that limit the consumer's choice to products with acceptable fire performance.

**Insurance carriers**

Although not strictly part of the regulatory framework, insurance carriers play an important role in fire safety provision. Insurance carriers are concerned with the potential for loss of life and property damage resulting from fires. Insurance companies have developed methods for assessing the fire risk in a facility to levy appropriate premiums. For large facilities, such as in industry, assessment methods can involve advanced engineering analysis. The Factory Mutual System and Underwriters Laboratories Inc. provide engineering services to support insurance carriers. These include development of insurance-industry fire standards, testing of the fire performance of products and inspection of industrial facilities.

The multi-layered structure of the regulatory framework provides checks and balances to ensure an acceptable level of fire safety in a facility. At the same time, the various layers of codes and standards and the large number of participants in the policing of regulations make the framework appear complex. As a result, it is common practice to engage a fire protection engineer with wide ranging expertise in fire-related codes and standards to formulate designs or strategies that ensure compliance with regulations in an economical and efficient manner.

**FIRE PROTECTION ENGINEERING**

Traditionally, fire safety regulations have been prescriptive; that is, detailed and often rigid solutions are mandated in codes and standards as the means to ensure fire safety. Such regulations are based on collective experience of what works and what does not, along with technological analysis and professional judgment. Statistics reveal that these

regulations work well for conventional buildings. Nonetheless, prescriptive fire safety solutions are often cumbersome and expensive when applied to the design of modern buildings.

A better understanding of the behavior of building fires is evolving through research. Computer software is available to model the spread and severity of a fire in a building as well as the response of building occupants, building components, and fire protection systems. Codes and standards are being revised to encourage performance-based design whereby the solution is tailored to address the hazard. These developments are opening the door for engineered fire safety solutions as an alternative to prescriptive regulations. Clearly, such design can only be undertaken by a well trained fire protection engineer.

Fire protection engineering is not yet a mature discipline. Few textbooks are devoted to the subject. Likewise, limited opportunities exist for studying the discipline<sup>5</sup>.

Nonetheless, it is an emerging discipline. It requires practical and fundamental training in the behavior of fires, fire protection systems, human behavior and risk assessment, as well as in basic engineering subjects such as thermodynamics, fluid mechanics and heat transfer. The fire protection engineer must also be aware of pertinent codes and standards, and the legal implications of the work. Mastery of the discipline requires a considerable commitment of time and effort.

Fire protection engineers interact with a wide variety of professionals in their daily activities including architects, structural engineers, building service engineers, construction personnel and regulatory authorities. Additionally, a client's or insurer's concerns may determine how the fire protection engineer provides solutions. Training presents a challenging task<sup>5</sup>, but employment opportunities abound with consulting groups, government agencies, industry, insurance companies and fire protection equipment manufacturers.

This module introduces basic fire protection issues related to the safeguarding of life and property against fire losses. It is intended to develop an engineering appreciation of standard practices and regulations related to the prevention, detection and suppression of fires.

## **ORGANIZATION OF MODULE**

To meet this objective, the module is divided into seven Units.

This section, Unit I, gives general background material. It presents U.S. fire loss statistics - particularly as they relate to the workplace. Most important, it provides an overview of the sometimes daunting regulatory framework intended to ensure fire safety.

Unit II provides an introduction to fire protection issues. The need is stressed for an understanding of the relationship between the scientific principles underlying fire science and effective fire protection measures. It is emphasized that a clear statement of the objectives of a fire safety analysis is necessary before effective solutions can be sought.

Unit III describes the fundamental principles of fire science. Unit IV introduces the study of room fire dynamics to stress the interrelationship between fire growth and the enclosure where the fire burns.

Unit V describes the practice of fire protection, including the role of codes and standards.

Guidance is provided on the selection of effective solutions to reduce fire hazards and to achieve pertinent fire safety objectives.

Units VI and VII provide overviews of two central components of fire safety design: fire detection and fire suppression.

#### REFERENCES

1. OSHA [1993]. OSHA Fact Sheet 93-41. Washington, DC: U.S. Department of Labor, Occupational Safety and Health Administration.
2. Hall JR [1996]. The U.S. fire problem overview report through 1994: leading causes and other patterns and trends; industrial and manufacturing facilities. Quincy, MA: National Fire Protection Association.
3. Karter M [1996]. NFPA's latest fire loss figures. *NFPA J Sept-Oct:52-59*.
4. NFPA [1992]. NFPA 1, Fire prevention code. Quincy, MA: National Fire Protection Association.
5. Magnusson S, Drysdale D, Fitzgerald R, et al. [1995]. A proposal for a model curriculum in fire safety engineering. *Fire Saf J 25:1-88*.

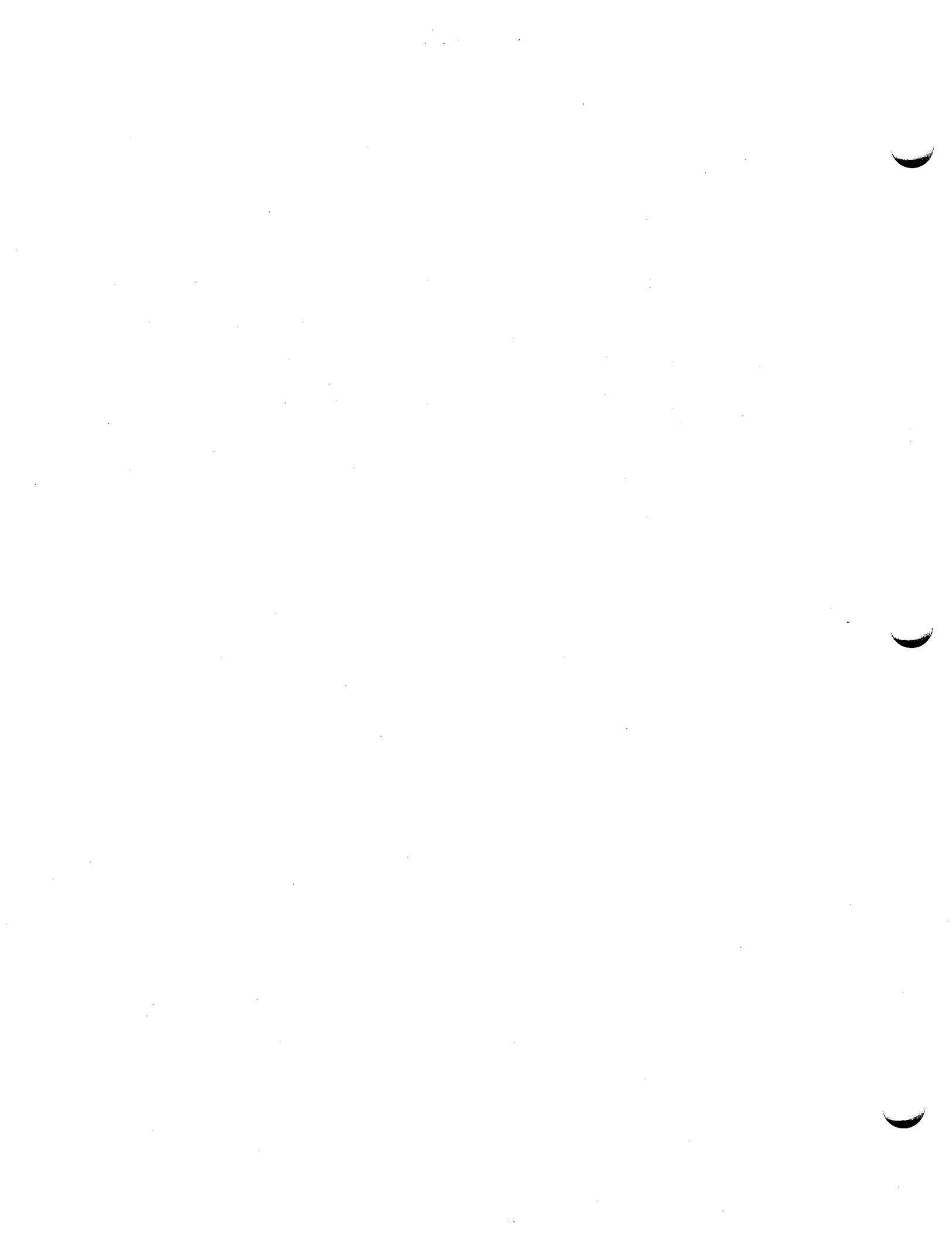

## Unit II INTRODUCTION

**PURPOSE:** To introduce the basic principles of fire protection engineering.

**OBJECTIVES:** To establish the relationship between the scientific principles underlying fire science and effective fire protection measures through:

1. Identification of pertinent fire safety objectives
2. Recognition of the range of hazards presented by fire
3. Identification of factors affecting the fire performance of materials
4. Development of effective design solutions to reduce hazards

**SPECIAL TERMS:**

1. Fire safety objectives
2. Building services
3. Fire hazards
4. Fire performance
5. Fire science
6. Fire dynamics
7. Detection
8. Suppression



## **FIRE SAFETY OBJECTIVES**

In general terms, the purpose of the regulatory framework discussed in Unit I is to mitigate fire hazards by mandating specific measures to achieve particular fire safety objectives. For example, specific objectives may be to ensure:

1. life safety,
2. property protection, and
3. minimal disruption to business.

When undertaking a fire safety analysis, the objectives must be clearly delineated at the outset. The objectives should be expressed in specific terms whenever possible. Although it is common practice, simply stating that the objective is to ensure life safety is not helpful. It would be more helpful to state that if fire occurs, the objective is to provide sufficient fire protection measures to ensure that occupants have sufficient time to escape to the outdoors (or at least to an area of refuge) before they are overcome by hazardous conditions. An objective stated in this fashion makes recommending various acceptable solutions possible. A choice among those solutions that meet the objective could then be made on the basis of other considerations such as aesthetics, economics or constraints related to other building services.

Given the complexity of the regulatory framework, a given requirement cannot always be directly linked with a single objective. Strategies that appear directed to life safety often serve the interest of property protection. For example, fire alarm systems, which are intended to provide early warning to occupants, may also alert the fire services to the presence of fire. Suppression activities may then begin early enough that property damage is reduced. On the other hand, the provision of sprinklers for property protection in a warehouse may mean that fire spread is held in check and hazards to employees are greatly reduced.

Fire safety objectives must be established in the context of the regulations at hand, the concerns of the insurance carrier, and the needs of the building occupants and owner. Fire safety objectives will be discussed further in Unit V.

Once fire safety objectives have been identified, effective solutions can be selected. Many solutions have been devised to address fire safety. For any application, part of the overall solution may be mandated by regulation, part requested by an insurance agent and part dictated by the functions performed in the facility. Ultimately, the purpose of this module is to provide insight on the selection of effective solutions to reduce fire hazards.

## **FIRE HAZARDS**

As suggested by the statistics reported in Unit I, the hazardous environment generated by a fire is a threat to life as well as to property. Although protection of occupants (including workers) from death and injury is a central fire safety issue, it is important to appreciate the range of hazards associated with fire.

In fire environments, respiratory system injury may result from breathing hot gases. Skin may be burned because of direct contact with hot gases or objects, or exposure to radiant heat. The threshold exposures that cause damage to property are different from those that represent hazards to humans, but the mechanisms are the same: direct contact with hot gases or exposure to radiant heat.

Smoke may obscure visibility and thereby impede both evacuation of a building and fire fighting efforts. Smoke also represents a toxic hazard to occupants and fire fighters. Property is potentially affected by smoke, as deposition of the products of combustion on electronic or other sensitive equipment can cause damage.

**FIRE  
PERFORMANCE  
OF MATERIALS**

Of course, if a fire grows large enough it will cause damage to the contents and structure of a building. There is ultimately the threat that fire will spread to neighboring buildings and thereby increase the sphere of damage.

A central issue in the provision of fire safety often relates to the selection of materials. Making the appropriate selection is challenging, since a large number of factors affect the fire performance of materials. A short description of some these factors follows. More detailed examples are found in later Units of this module.

The basic chemical composition of a material is of great significance in determining its fire performance. Some materials, such as organic compounds, are combustible (in air), whereas most inorganic compounds are not. Within the class of combustible materials much variability exists in "degree of combustibility". Some materials are easily ignited or have a high propensity to spread flames while others do not. A great deal of energy is released during the combustion of some materials and relatively little from others.

Availability of air can be as important as the chemical composition of the fuel in determining the nature of a fire. For example, the rate of burning of materials and the nature of the products of combustion depend on the availability of oxygen (air).

The physical properties of a material also impact its involvement in fire. For example, gaseous, liquid and solid fuels exhibit quite different behaviors in a fire. The physical size and density of a solid fuel influence its burning characteristics. For example, while igniting a thin strip of wood is easy, igniting a log is difficult even though the chemical composition of the two is identical. Likewise, while igniting some foamed plastics is easy, the high density form of the same plastic is more difficult to ignite.

Even materials that are noncombustible may have other properties that have an impact on the development of fire, and the safety of life and property. Glass windows may break when exposed to high temperatures and suddenly admit fresh air to an otherwise poorly ventilated fire. Unprotected steel structural elements may undergo thermal expansion early in a fire and thereby induce instability in the building structure. Upon further heating, such elements can lose a significant fraction of their strength and cause structural collapse.

As the above examples suggest, a large number of factors affect the development and severity of fire. Fire involves a sensitive interplay of chemical, heat transfer and fluid mechanical phenomena. As the fire scenario changes so does this interplay. Developing sound fire safety strategies entails much more than just the selection of materials.



**Unit III**  
**FUNDAMENTALS OF FIRE SCIENCE**

**PURPOSE:** To introduce the fundamental principles of fire science.

**OBJECTIVES:** To acquaint the reader with:

1. The chemical reactions associated with fire
2. The impact of fuel properties on fire performance
3. The structure and dynamics of flames
4. Products of combustion

**SPECIAL TERMS:**

1. Fire tetrahedron
2. Gaseous fuel
3. Liquid fuel
4. Solid fuel
5. Pyrolysis
6. Thermoplastic
7. Thermoset
8. Diffusion flames
9. Premixed flames
10. Flammability limits
11. Flash point

## INTRODUCTION

This Unit introduces fundamental science and engineering related to fires to develop an appreciation of the principles on which fire regulations and fire protection systems are based.

## FIRE TETRAHEDRON

Fire is a process entailing rapid oxidative, exothermic reactions in which part of the released energy sustains the process. The fire tetrahedron presented in Figure III-1 depicts the components required for the existence of a fire and thereby suggests how to prevent and suppress fires. A fuel is necessary to provide a source of material for the exothermic reaction. An oxidant, usually oxygen in air, must be present. For fire to be initiated (or sustained) a source of heat must also be present. This heat can be in the form of a spark, a flame or perhaps just a heated environment. Finally, the relative concentrations of fuel vapors and oxygen entering the flame must be appropriate to initiate or sustain the complex chain reactions that typify flame chemistry.

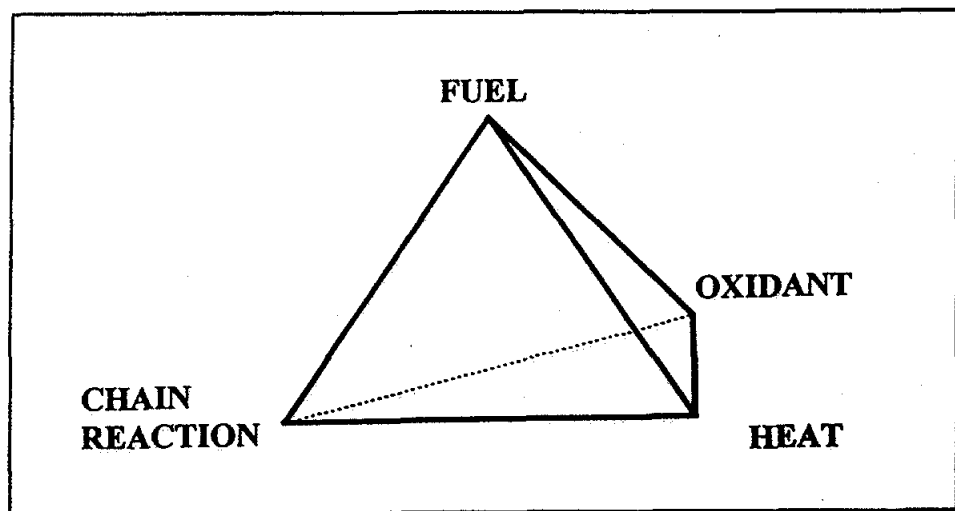

Figure III-1. The Fire Tetrahedron. The four elements required to initiate and maintain fire are shown as the four corners of the fire tetrahedron.

If just one of these four components is absent, fire cannot be initiated or sustained. If no fuel, oxidant or ignition source is present, fire will not occur. Furthermore, the relative concentrations of fuel vapors and oxidant must be such that self-sustaining chemical reactions can be established. Fire prevention strategies are often based on creating a situation in which at least one of the four components of the fire tetrahedron is unlikely to be present.

If, however, flaming has already been established, it may be suppressed by the removal of one of these four components. Flaming will clearly cease if fuel vapors are eliminated, for instance by ensuring that there is an automatic shut-off on a gas supply line in the event of an unwanted fire involving that gas line. Fire can also be suppressed by preventing oxygen from reaching a flame, for instance by smothering it with a blanket. Heat is routinely removed from fire by the application of water streams by firefighters or automatic sprinkler systems. Finally, the complex chain reactions within the flame can be inhibited by the judicious application of special chemicals.

## FIRE AS A CHEMICAL REACTION

As noted earlier, fire is a process entailing rapid oxidative, exothermic reactions in which part of the released energy sustains the process. In simple terms, fire can be represented according to the following word equation:

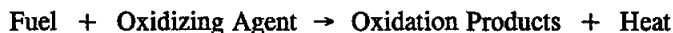

If the fuel is a hydrocarbon,  $C_xH_y$ , and the oxidizing agent is oxygen,  $O_2$ , combustion of the fuel is described by the chemical equation:

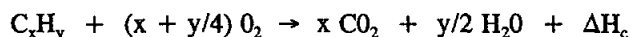

This equation assumes complete combustion; that is, the fuel is entirely consumed and the products of combustion include only carbon dioxide,  $CO_2$ , water vapor,  $H_2O$ , plus heat. The heat released in an oxidative reaction,  $\Delta H_c$ , is referred to as the heat of combustion.

In a fire, water comes off as a vapor, so common use is made of the net heat of combustion, which automatically accounts for the latent heat of vaporization of water. For simple fuels, the heat of combustion can be determined directly from basic thermodynamic parameters (i.e. heats of formation) and the influence of ambient temperature and pressure conditions can be accounted for.

With more complex fuels (in particular solids), for which the molecular formula may not be known with precision, the heat of combustion must be measured experimentally. A common means for measuring heat release during combustion reactions is to combust the fuel in a pure oxygen atmosphere within an oxygen bomb calorimeter. The concentration of fuel within the apparatus is adjusted to ensure complete combustion. A table of net heats of combustion for some common fuels is shown in Table III-1.

Table III-1  
Heats of Combustion of Selected Materials at 25°C

Material	$\Delta H_c$ (kJ/g)	$\Delta H_{c,ox}$ (kJ/g $O_2$ )	State
Methane, $CH_4$	50.0	12.5	g
Propane, $C_3H_8$	46.5	12.8	g
Benzene, $C_6H_6$	40.0	13.1	l
Cellulose	16.1	13.6	s
Polyethylene	43.3	12.7	s

$\Delta H_c$  is the heat of combustion per gram of material while  $\Delta H_{c,ox}$  is the heat of combustion based on the mass of oxygen reacted. The states of materials are given as follows: "g" is a gas, "l" is a liquid and "s" is a solid. Additional information about heats of combustion can be found in SFPE Handbook, Fire Protection Engineering<sup>1</sup> or in Fire Dynamics<sup>2</sup> by D. Drysdale as well as in standard thermodynamic source books.

The heat liberation in a fire can be related to the amount of oxygen consumed (see Table III-1). The heat of combustion per gram of oxygen consumed for most organic liquids is about 12.7 kJ and the heat of combustion per gram of oxygen consumed for most combustible solids is about 13.0 kJ. These findings can be quite useful in characterizing heat release when the availability of oxygen is restricted.

The discussion above assumes complete combustion of the fuel. This situation is generally not the case. The combustion of vapors, liquids and solids in air usually results in the evolution of some carbon monoxide (CO), soot (mostly carbon, C), and other chemical species in addition to CO<sub>2</sub> and H<sub>2</sub>O. Visible smoke and the appearance of a flame can both be attributed to incomplete combustion and, in particular, to the generation of soot. Moreover, the appearance of a visible flame is due to thermal radiation emitted by the incandescent soot particles. Well-ventilated flaming combustion does not generate sufficient CO to be an immediate threat to occupants; however, the less well ventilated a fire is, the larger the yield of CO and soot.

## TYPE OF FUEL

Vapors, liquids or solids can provide the fuel for a flame. However, since flaming combustion is a gas phase phenomenon, liquids and solids must first be vaporized to generate vapors for the flame. As the combustion of vapors is common to flames associated with the burning of vapors, liquids and solids, the flaming combustion of vapors should be discussed first.

### Vapor

Two scenarios exist in which the fuel for flames is in the form of a vapor. If the vapor and the oxidant are intimately mixed before combustion, the flame is referred to as a premixed flame. Not all concentrations of vapor in air will ignite. A vapor of a specified material will ignite with air within upper and lower flammability limits (UFL and LFL). Above the UFL the mixture is too rich in fuel to sustain combustion and below the LFL too little fuel is present to maintain heat generation at a level high enough to sustain the reaction. Because a vapor mixture cannot be ignited if it remains below its LFL, a common fire prevention measure is to provide adequate mechanical ventilation in areas where combustible vapors may be present. This measure ensures that the vapor concentration never reaches the LFL. Tables of UFLs and LFLs are available in the literature<sup>3,4</sup>.

The LFL of a vapor decreases with increasing temperature, and the UFL increases. Therefore, as temperature increases, the range in which vapors are flammable also increases. The LFL is generally insensitive to changes in pressure above atmospheric but the UFL increases with pressure. The flammability range of a material is therefore broadened as pressure increases above atmospheric.

A mixture within its flammability limits can be ignited by a small ignition source. This process is referred to as piloted ignition. Following ignition, a deflagration ensues in which chemical reactions (and hence a flame) propagate rapidly through the mixture. In the absence of a localized ignition source (or pilot), a mixture within its flammability limits will "self-ignite" if heated to temperatures above its auto-ignition temperature. Again a deflagration follows ignition.

As the deflagration propagates, the temperature of the flame and combustion products is very high. If the mixture is confined, the pressure also rises rapidly. If no means of relieving pressure is available, the walls of the confining structure may explode.

The second type of flame associated with gas phase fuels is a diffusion flame. In a diffusion flame, the gaseous material and the oxidant come from spatially separated sources and must mix before combustion can occur. Chemical reaction occurs when the mixture is between its flammability limits. For small flames, mixing takes place by molecular diffusion; whereas for larger flames (diameter > 0.5 m), turbulent eddies cause mixing. Because mixing must occur before combustion begins, the rate of heat release is slower for diffusion flames than for premixed flames. The usually luminous flame defines the region where the reaction occurs.

## Liquid

Fires involving liquids are different from those involving gases because vaporization of the liquid must occur before fire can begin. The thermodynamic properties of the liquid (e.g., equilibrium vapor pressure as a function of temperature) as well as the heat and mass transfer characteristics of the situation determine the potential for combustion. A liquid can only be ignited by a pilot if its vaporization rate is sufficient to ensure that the vapor/air mixture at the liquid surface is within the flammability limits of the fuel.

Liquids are classified according to the lowest temperature at which an air and vapor mixture will combust at its surface. This temperature is called the flash point of the liquid (see Table III-2). At the flash point, flames flash across the liquid surface but sustained flaming may not result. The fire point is a somewhat higher temperature at which burning will be sustained once the vapors have been ignited (see Table III-2). The difference between the flash point and the fire point relates to the complex manner in which energy is generated in the reaction in the gaseous phase and transferred back to the liquid surface, thereby vaporizing more potentially combustible material.

Table III-2  
Flash and Fire Points of Selected Liquids

Liquid	Flash Point (°C) (Closed Cup)	Flash Point (°C) (Open Cup)	Fire Point (°C)
Ethanol, C <sub>2</sub> H <sub>5</sub> OH	13	18	18
n-Decane, C <sub>10</sub> H <sub>22</sub>	46	52	61.5
Fuel Oil	-	133	164
Diesel Fuel, North America	-	82-166	103-200

Flash point measurements are method sensitive. Values are reported for a closed cup method and for an open cup method (where evaporated material has the potential to diffuse away from the evaporating surface). The fire point is based on sustained burning following ignition in an open cup. Additional information can be found in SFPE Handbook, Fire Protection Engineering<sup>5</sup> or in Fire Dynamics<sup>6</sup> by D. Drysdale, Table 6.4.

The flash point of a liquid is used to classify its flammability as indicated in Figure III-2. A liquid is classified as flammable if its flash point is low enough that it could be ignited at temperatures it could experience on a day to day basis in a facility (that is, less than 100°F [38°C]). A liquid is classified as combustible when its flash point is greater than or equal to 100°F (38°C). Additional considerations apply to mixtures of liquids. This



classification is a convenient way to characterize the fire hazard of a liquid. Fire safety measures regulating the storage of flammable liquids are very strict, but more leeway is granted for the storage of combustible liquids if they will not be unduly heated.

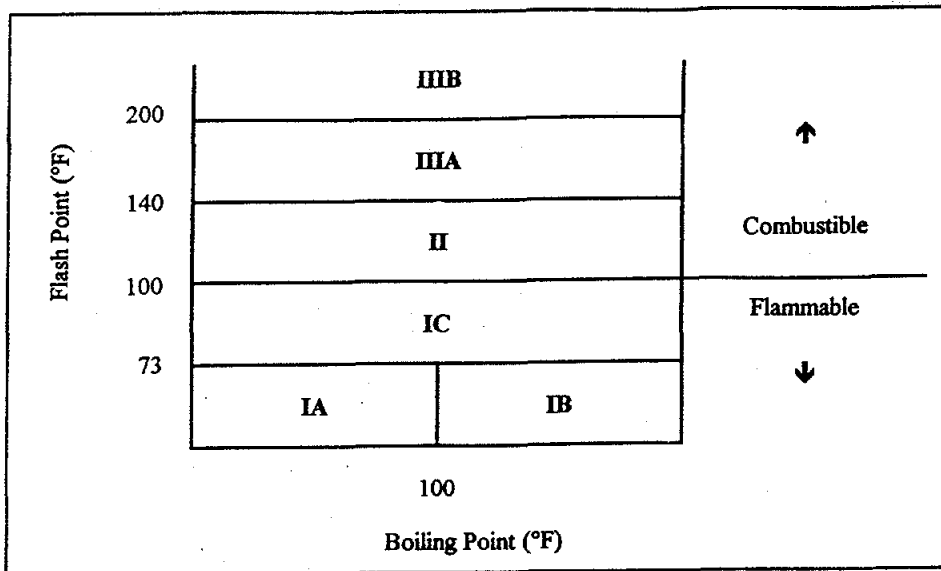

Figure III-2. Combustible Liquid Flammability Classification. Classification of a liquid as flammable or combustible based on OSHA 1910.106<sup>7</sup> is shown in this figure. Flammable liquids (IA, IB and IC) are defined as those with a closed cup flash point of less than 100°F, whereas combustible liquids (II, IIIA and IIIB) have a flash point at or above 100°F. Additionally, the liquid boiling point is used to classify liquids with low flash points (IA and IB). This classification system is used, for example, to determine the allowable container type and volume for storage of liquids.

## Solid

The mechanisms involved with burning of solids are more varied and more complex than those for gas phase or liquid fuels. As with liquids, flaming combustion involves conversion of the solid to a vapor which then becomes involved in the exothermic reaction that is characteristic of the flame. In addition, some solids can undergo smoldering in which the solid material is oxidized directly. Our focus is on flaming of solids.

Combustible solids are generally polymeric (i.e. composed of macromolecules). Macromolecules are too large to be vaporized directly, so as heat is transferred to a solid surface from a flame, vapors can only be generated if chemical bonds within the macromolecules are broken and smaller molecular species are generated. This process of thermal decomposition (or pyrolysis) requires much more energy than simple evaporation, which dominates vapor generation for liquids. As a consequence, the surface temperature of a solid must usually be raised to a much higher level than a liquid before significant amounts of vapor are released and ignition is achieved. The temperature at the surface of burning solids is usually > 350°C.

Some plastic materials, referred to as thermoplastics, melt at a temperature lower than their ignition temperature. Examples include polyethylene, polypropylene and polystyrene. Other materials, referred to as thermosets, do not melt but decompose to generate vapors and a carbonaceous char. Only thermosets are susceptible to smoldering; examples include wood, wool and polyurethane. Whether a solid is thermoplastic or thermosetting depends on its basic molecular structure.

For thermosets, char development on the solid surface may impede heat transfer from the flame to the unburnt solid material and thereby reduce burning rates. The burning of wood demonstrates the complexities involved with heat and mass transfer in a combustible solid. As wood is heated to temperatures around 100°C, water vapor is driven off. At higher temperatures (200-250°C) the wood begins to discolor as pyrolysis begins. However, combustible vapors are not generated in sufficient quantity to cause the wood to be ignited until wood reaches a temperature of 350-390°C. Although the combustible vapors reach the diffusion flame where reaction generating heat takes place, the carbonaceous char is left in place. As the wood continues to burn, the pyrolysis zone recedes deeper into the solid and the char thickens. The char layer insulates the interior of the wood and thereby impedes the generation of vapors. If not enough combustible vapor is given off, the flame will cease allowing oxygen to contact the hot char, and smoldering may begin.

The types and amounts of polymeric materials used in industry, offices, and residences have increased very rapidly. Many of these materials have unique combustion properties. Although the combustion of all fuels generates toxic gases, some fuels produce more toxic substances than others. A wide range also exists in the burning rates of polymeric materials. An important characteristic of burning rates of liquids and solids is the ratio of the heat of combustion of the material to the heat required to generate vapors. In general this ratio is much higher for liquids and hence liquids burn more vigorously than solids.

To reduce the potential and consequence (hence the risk) of solid fires, fire retardants are used. Retardant action can range from chemically altering polymeric materials, to impregnating materials with fire retardant chemicals or to coating the surface of solids with materials that may interfere with flame spread or pyrolysis. Fire retardant coatings include paints that expand to form insulating coatings when exposed to fires, impervious noncombustible materials such as ceramics, coatings that release noncombustible gases at elevated temperatures and thereby reduce the oxidant concentration surrounding the solid environment, and cement-like or fibrous coatings that improve the fire-resistance properties of the composite-solid material.

## **FLAMING COMBUSTION**

Sustained flaming combustion is a complex, interrelated heat and mass transfer phenomenon that depends on heat produced through chemical reaction. Figure III-3 depicts a typical flame associated with the burning of a liquid or solid surface. Fuel vapors generated at the surface are swept into the flame because of buoyant forces. These buoyant forces also give rise to turbulent eddies that draw fresh air into the flame. The fuel vapors and oxygen from air mix and undergo chemical reactions. A great deal of heat is released making the flame hot and buoyant. Products of combustion are carried upward in the plume rising above the flame. At the same time, some of the heat released by chemical reactions is transferred back to the liquid or solid surface causing more fuel vapors to be liberated and the cycle continues.

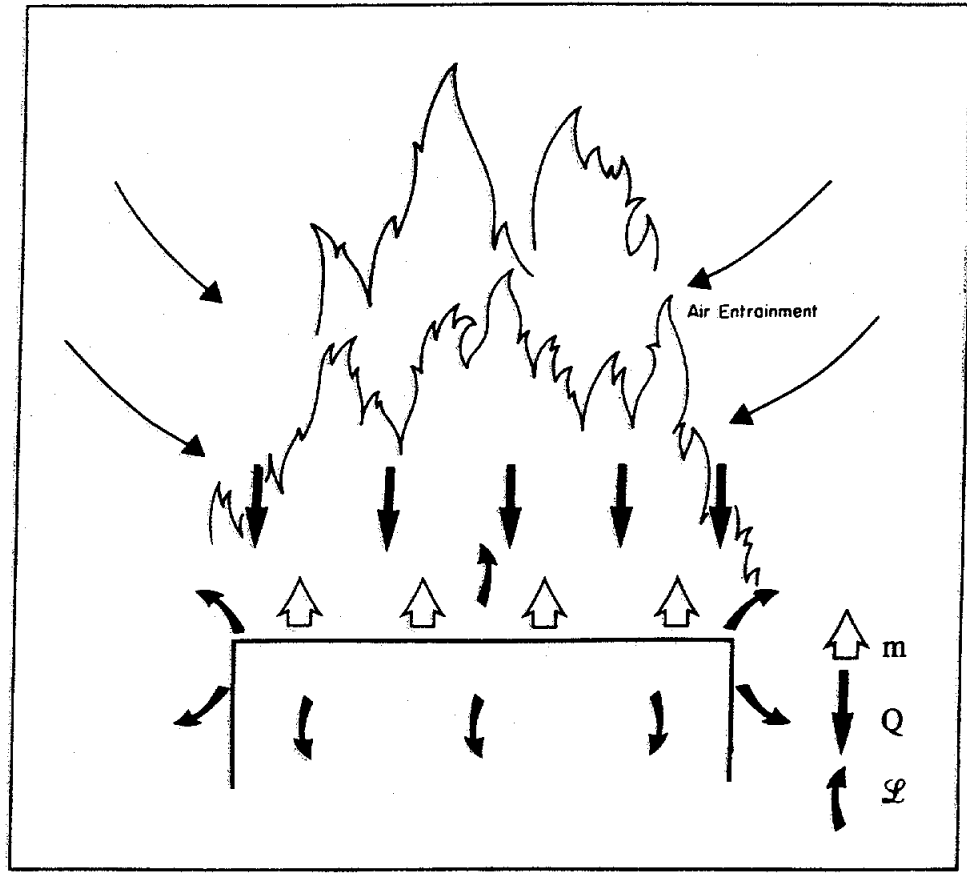

Figure III-3. Heat and Mass Transfer Associated with a Burning Surface.

Copyright by John Wiley and Sons Ltd. Reprinted with permission from D. Drysdale, "An Introduction to Fire Dynamics", J. Wiley and Sons, Chichester, (1985).

Flames, such as those depicted in Figure III-3, are referred to as turbulent diffusion flames and are associated with liquid or solid fires of diameter greater than 0.3 m. For smaller diameter fires, the flames are not turbulent but steady (laminar) and the mixing of vapors and oxygen takes place primarily by molecular diffusion.

In Figure III-3,  $Q$  represents the rate at which heat is supplied by the flame to a unit area of the surface and  $\mathcal{L}$  is the rate at which heat is lost by a unit area of the surface. The difference between these heat transfer rates is the net heat flux absorbed by the surface. The absorption of this heat results in the evaporation of a liquid (or gasification of a solid) and thereby generates fuel vapors for the flame. If  $L_v$  is the latent heat of vaporization for a liquid (or the heat of gasification for a solid), the rate at which vapors are liberated per unit area of the surface,  $m$  is:

$$m = (Q - \mathcal{L})/L_v$$

Therefore, the rate at which vapors are generated (i.e. the rate of burning) depends on the rate of heat transfer from the flame. This rate of heat transfer depends critically on the rate at which heat is released in the flame which, in turn, depends on the heat of

combustion of the fuel. For well-ventilated fires the rate of burning is particularly rapid for materials for which the heat of combustion is much larger than the heat required to generate gases.

## Oxidant

Flame chemistry, flame temperature and heat release rates depend on the amount of oxidant available for the chemical reaction. Poorly ventilated (air starved) flames tend toward incomplete combustion with both reduced temperatures and heat release rates.

In most fires, oxygen is the oxidizing agent, and it is usually derived from air. However, halogenated compounds, peroxides, acids, and nitrites (among others) can also serve as oxidizers in an exothermic reaction with a fuel. Explosives and highly reactive fuels owe their intense reactivity to the presence of molecular components with oxidizing capacity within their makeup. The following discussion is restricted to consideration of air as the oxidizer in combustion processes.

As has been mentioned, in diffusion flames, oxygen and fuel are supplied to the combustion zone, usually from different directions. Buoyancy (based on temperature gradients) and physical aspects of the fire scenario play important roles in determining how oxygen reaches the combustion zone. Flames are not usually stationary, but rather the reaction zone moves about in a complex manner depending on the availability of both fuel and oxygen. Flames usually behave in a turbulent manner. A large amount of oxygen can be entrained into the combustion zone as shown in Figure III-3. The size of the surface from which fuel is being generated for combustion also plays a role in oxygen delivery to the reaction interface. If the surface is small, the flames tend to be elongated and oxygen is supplied to the flame by molecular diffusion through the large flame front area. At the other extreme, if the surface is large, then the flame will be relatively short with a relatively smaller flame front area through which oxygen is supplied by turbulent mixing.

The inability to deliver oxygen to flames emanating from a surface limits the burning rate of that surface. This situation can be of practical significance in the case of a fire in an enclosure (i.e. room) that is initially limited by the availability of oxygen through vents or other openings. If an enclosure fire that is limited by oxygen delivery to the reaction zone receives sufficient oxygen (for example after windows break) the combustion reaction will increase dramatically leading to events that increase the severity of the fire. The dynamics of such fires will be discussed in greater detail in Unit IV.

## IGNITION SOURCES

The common ways fuels are ignited into fires are through piloted ignition, spontaneous ignition (auto-ignition) or through self heating of the fuel. The first source of ignition is the most common and can result from flames or sparks. Auto-ignition can result if materials are externally heated to the auto-ignition temperature causing the material to burn spontaneously. The last means of ignition discussed is the least likely to occur and relates to internal heating of the fuel through scenarios such as biological reactivity or drying.

Ignition of a gas can only occur when the vapor mixture is within the upper and lower flammability limits (UFL and LFL). Additionally, a minimum ignition energy is required for combustion to be initiated. For example, simple hydrocarbons require approximately 0.25 mJ to ignite stoichiometric mixtures at 1 atmosphere and 25°C. A typical electrical spark has about 25 mJ of discharge energy and the static electrical energy generated in a spark from walking across a rug is approximately 20 mJ<sup>8</sup>.

Because a vapor mixture above its LFL can be ignited easily by electrical sparks, a sound fire prevention measure is to require only well designed electrical equipment with proper grounding for use in areas where combustible vapors may collect.

As has been mentioned earlier, the initiation of flaming combustion of a liquid or a solid fuel is slightly more complex. A flammable vapor/air mixture must first be generated at the fuel surface by either evaporation (liquid) or gasification (solid). Once the mixture reaches the LFL an ignition source can initiate flaming combustion as discussed earlier.

#### REFERENCES

1. Drysdale D [1995]. Thermochemistry. In: SFPE handbook of fire protection engineering. 2nd ed. Ed by DiNenno PJ, Beyler CL, Custer RLP, Walton WD, Watts JM Jr, Drysdale D and Hall JR Jr. Quincy, MA: National Fire Protection Association, p. 1-83, Chapter 1-5, Table 1-5.3.
2. Drysdale D [1985]. Table 1.13. In: An introduction to fire dynamics. Chichester, UK: John Wiley and Sons, p. 21.
3. Drysdale D [1985]. Table 3.1. In: An introduction to fire dynamics. Chichester, UK: John Wiley and Sons, p. 80.
4. Beyler C [1995]. Flammability limits of premixed and diffusion flames. In: SFPE handbook of fire protection engineering. 2nd ed. Ed by DiNenno PJ, Beyler CL, Custer RLP, Walton WD, Watts JM Jr, Drysdale D and Hall JR Jr. Quincy, MA: National Fire Protection Association, p. 2-150, Chapter 2-9, Table 2-9.1.
5. Kanury AM [1995]. Ignition of liquid fuels. In: SFPE handbook of fire protection engineering. 2nd ed. Ed by DiNenno PJ, Beyler CL, Custer RLP, Walton WD, Watts JM Jr, Drysdale D and Hall JR Jr. Quincy, MA: National Fire Protection Association, p. 2-164, Chapter 2-10, Table 2-10.4.
6. Drysdale D [1985]. Table 6.4. In: An introduction to fire dynamics. Chichester, UK: John Wiley and Sons, p. 197.
7. CFR. Code of Federal regulations. Washington, DC: U.S. Government Printing Office, Office of the Federal Register.
8. Crowl D, Louvar J [1990]. Chemical process safety: fundamentals with applications. Englewood Cliffs, NJ: Prentice Hall, p. 201.

### SAMPLE QUIZ QUESTIONS

1. a) Hexane [ $C_6H_{14}$ ], benzene [ $C_6H_6$ ], ethanol [ $C_2H_5OH$ ], and acetone [ $(CH_3)_2CO$ ] are liquids at room temperature and atmospheric pressure. Write the chemical equations describing the complete combustion of each of these liquids.
  - b) Use the chemical equations derived in (a) and the molecular weights of the reactants to determine the mass of oxygen consumed in the complete combustion of 1 gram of each of these four liquids.
  - c) The net heat combustion of  $C_6H_{14}$  is 45.10 kJ/g; of  $C_6H_6$  is 40.00 kJ/g; of  $C_2H_5OH$  is 26.78 kJ/g; and of  $(CH_3)_2CO$  is 30.79 kJ/g. Calculate the net heat of combustion per gram of  $O_2$  when each of these liquids undergoes complete combustion.
2. When acetone [ $(CH_3)_2CO$ ] burns in a pool configuration in the open, for every gram of acetone consumed, 2.14 g of  $CO_2$ ; 0.003 g of CO and 0.014 g of soot (C) are formed. Clearly in this configuration acetone does not undergo complete combustion. On the other hand, when atomized in a fine spray in an oxygen enriched environment, acetone can be made to undergo almost perfect combustion. Calculate the mass of carbon dioxide ( $CO_2$ ), carbon monoxide (CO) and soot (C) generated in the complete combustion of 1 gram of acetone.
3. The lower flammability limit (LFL) for alkanes (simple carbon and hydrogen molecules) is approximately 48 g/m<sup>3</sup>. Assume air has density of 1.2 kg/m<sup>3</sup> and a molecular weight of 28.95 g/mole. Convert the LFL given above as mass concentration into the LFL (by % volume) for methane ( $CH_4$ ), n-hexane ( $C_6H_{14}$ ) and n-decane ( $C_{10}H_{22}$ ), and compare the results to tabulated values.
4. Consider a flame in which methane ( $CH_4$ ) reacts with just a sufficient quantity of air to react the fuel completely. Assume the methane and air are initially at 25°C.
  - a) Determine the amount of energy liberated by the complete reaction of one mole of methane with oxygen at 25°C. This information can be found in chemistry, thermodynamics or engineering texts, or reference books.
  - b) Determine the energy involved in vaporization of water produced in the reaction.
  - c) Calculate the adiabatic flame temperature. Assume no heat is lost to the surroundings (i.e. adiabatic conditions). Assume air is 21% oxygen and 79% nitrogen. Assume the products of combustion and the nitrogen are raised to the same final flame temperature.
5. Suppose acetone and n-heptane are stored in bottles in separate storage cabinets maintained at 25°C. The lids of the bottles are not secured so that each liquid evaporates until its equilibrium vapor pressure is achieved within the cabinet. Assume the cabinet pressure is slowly relieved so it remains at its atmospheric value. (Equilibrium vapor pressures for many liquids can be found in tables, charts or they can be calculated using empirical relationships such as Antoine's equation.)
  - a) Do flammable conditions exist within each cabinet?
  - b) What other considerations must be taken into account with regard to flammability if the doors to these cabinets are opened?

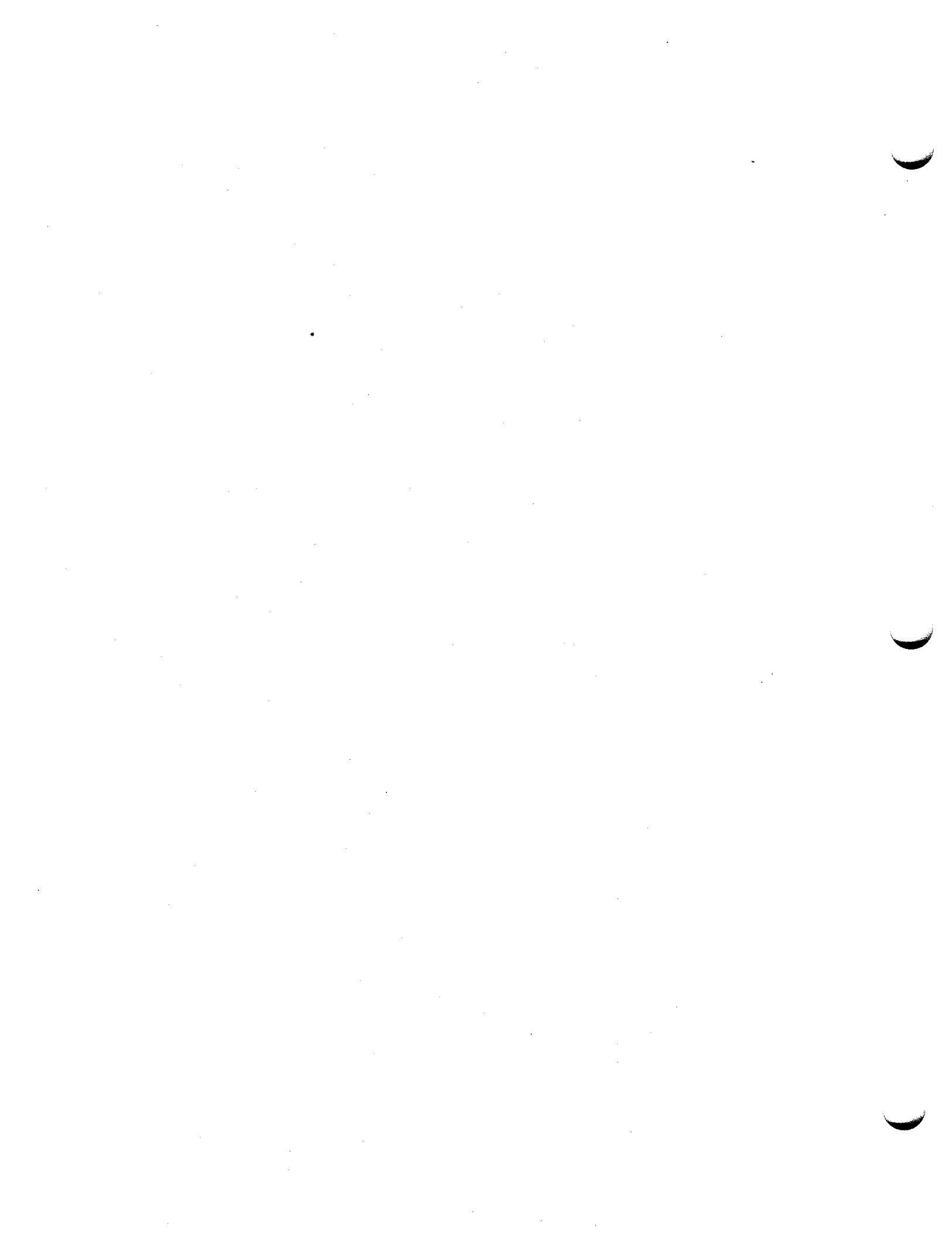

**Unit IV**  
**DYNAMICS OF FIRE**

**PURPOSE:** To familiarize the reader with the determinants of the growth and severity of fire.

**OBJECTIVES:** To acquaint the reader with:

1. The role of heat transfer in enclosure fires
2. The role of reduced air supply in enclosure fires
3. The stages of fire growth within enclosures
4. Measures of fire severity
5. The threat to life and property

**SPECIAL TERMS:**

1. Radiant heat transfer
2. Convective heat transfer
3. Conductive heat transfer
4. Entrainment of air
5. Products of combustion
6. Fire growth rates
7. Flame spread
8. Flashover
9. Smoke production
10. Smoke toxicity



## INTRODUCTION

In Unit III, fundamental scientific and engineering principles were presented to impart an understanding of the basic characteristics of fire. The impact that an enclosure or room may have on the course of a fire was not addressed. In this Unit, the relationship between fire growth and the enclosure within which the fire burns is highlighted.

## HEAT TRANSFER IN FIRES

In fire environments, heat is transferred from regions at high temperature to regions at lower temperature by the three traditional modes: conduction, convection and radiation. To understand the dynamics of fire growth within an enclosure, the roles played by each of these modes in fire-related phenomena must be studied.

### Conductive heat transfer

Heat transfer by conduction refers to the transfer of heat between solid materials in direct contact with each other and to the transfer of heat within solid materials<sup>1</sup>. (Although heat conduction also occurs in liquids and gases, its effect is generally masked by convection in fires.) Conductive heat transfer is governed by the thermal conductivity of a material and the presence of temperature gradients. For most building elements (excluding steel and aluminum) heat conduction is a slow process. It can take 20 minutes for the effects of heating on one side of a 50 mm slab of concrete to become noticeable on the other side.

Solids with low thermal conductivity are considered thermal insulators. For a limited time, they can be useful for protecting materials that are adversely affected by direct fire contact. On the other hand, as a consequence of being poor conductors, their surface temperature rises very quickly when exposed to fire. Hence good thermal insulators that are combustible are often easy to ignite.

Conductive heat transfer plays a major role in the ignition and spread of a flame over combustible solids. Conduction is also responsible for the transmission of heat through building elements, such as floors and walls. Floors and walls that inhibit the transmission of heat for some time impede the spread of fire to other rooms, and are hence referred to as fire resistant.

### Convective heat transfer

Convection involves the transfer of heat as a result of the movement of a gas (or liquid). In fire scenarios, the portion of the heat released within flames that is carried away by the hot products of combustion is referred to as convected heat. Because of buoyant forces, convection of hot gases usually occurs upward. Convection is the process whereby fire gases are transported throughout a building and therefore pose risks to occupants far from a fire.

The term "convective heat transfer" is used in fire safety engineering to denote heat transfer between a fluid and a solid surface that are at different temperatures<sup>2</sup>. When a flame impinges on a solid, heat is transferred by convection from the hot flame to the cooler solid. On the other hand, if a hot solid is in contact with cool air, heat is transferred from the solid to the air. In a fire scenario a solid may be heated or cooled by convective heat transfer.

In fire safety engineering analyses, it is commonly assumed that human survival would be impossible in a space within a building if the temperature of the air (or smoke) in it exceeds 120°C. Under such circumstances, convective heat transfer from the hot gas would cause serious burns to the skin and respiratory systems of humans.

## Radiative heat transfer

Hot objects emit thermal radiation in the form of electromagnetic waves, which can travel across space or through materials<sup>3</sup>. A significant fraction of the thermal radiation emitted by flames lies in the infrared region. In Table IV-1, the emissive power of a hot object or smoky gas is listed as a function of its temperature. Emissive power is the rate at which radiant energy is emitted per unit surface area of the object. The emissive power of an object climbs dramatically as it is heated. For hot gases in contact with a solid object, radiative heat transfer is much greater than convective heat transfer when the gas temperature exceeds 200-300°C.

Table IV-1  
Emissive Power of Hot Objects or Smoke

Temperature (°C)	Emissive Power (kW m <sup>-2</sup> )
20	0.4
200	2.6
400	10.5
600	29.6
800	67.6
1000	134.0

In small fires, hot products of combustion transport most of the heat released away from the combustion zone by convection. In larger fires (fuel diameter > 0.3 m), approximately 30% of the heat released is radiated away by soot particles in the flame. A hot upper layer in a room can emit sufficient radiant energy to cause combustible items on the floor that are not in direct contact with the flames or hot layer to be heated and possibly even ignited. In fact, thermal radiation emitted by flames issuing from the windows of a burning building have caused ignition of combustible elements of neighboring buildings.

Although a flame has significant emissive power, as one moves further from the flame the radiant heat impinging on objects decreases. Models are available to calculate the radiation received by an object remote from a source of known emissive power. Table IV-2 provides a rough guide to the effects of radiant energy impinging on various objects<sup>4</sup>.

Table IV-2  
The Effect of Radiant Energy Impinging on Various Objects

Radiation Level (kW m <sup>-2</sup> )	Effect on Objects
1.0	Minimal injury for prolonged skin exposure
6.4	Pain after 8 second skin exposure
10.4	Pain after 3 second skin exposure
12.5	Wood can be ignited by a pilot after 15 minute exposure
30.0	Most combustibles can be ignited by a pilot after 2 minute exposure

## ROOM FIRE DYNAMICS

Fire dynamics refers to the interactions among the complex phenomena associated with a building fire<sup>4</sup>. To understand the fire performance of materials and structures, it is first necessary to know something about fire dynamics and, hence, the conditions to which materials and structures may be exposed in building fires.

Immediately following ignition, an object burning in a room behaves as if it were burning in the open as described in Unit III. After a short period of time, however, confinement begins to influence fire development. The smoke produced by the burning object rises to form a hot gas layer below the ceiling as depicted in Figure IV-1. This layer heats the ceiling and upper walls. Thermal radiation from the hot layer, ceiling and upper walls then heats all objects in the lower part of the room and may augment both the rate of burning of the original object and the rate of flame spread over its surface.

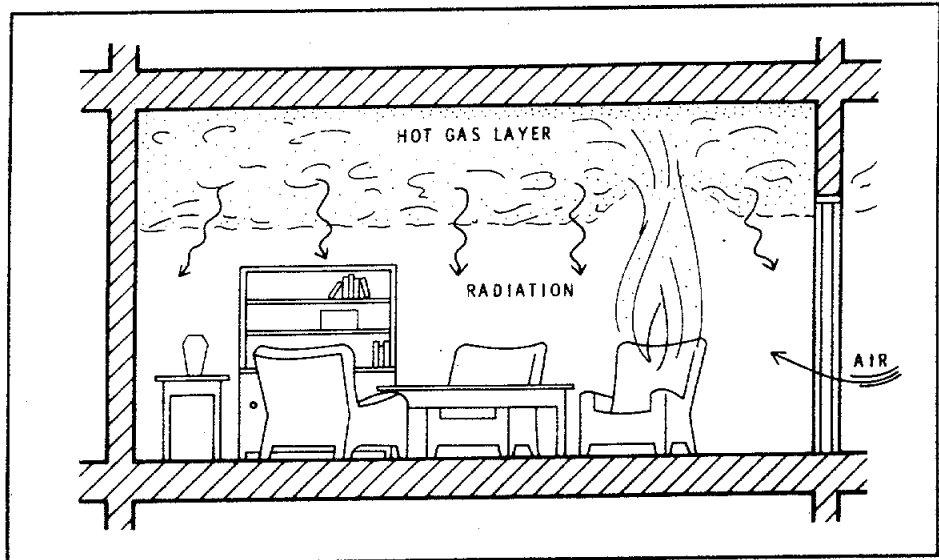

Figure IV-1. During the early stages of a fire, radiant energy, emitted by the hot smoky layer in a room, heats objects throughout the room.

Copyright by National Research Council Canada. Reprinted with permission from reference 5 by the U.S. Department of Health and Human Services. Further reproduction is prohibited without permission of the copyright holder.

At this point, the fire may go out if, for example, the first object burns completely before other combustibles ignite or if sufficient oxygen cannot get into the room to sustain combustion. Often, however, the fire gets sufficient oxygen through an open door or broken window, and the heating of the other combustibles in the room continues to the point at which they reach their ignition temperatures. Flames then suddenly sweep across the room, involving most combustibles in the fire. This transition from the burning of one or two objects in the room to full room involvement is referred to as flashover.

Following flashover, the fire burns vigorously for some time until the combustibles are mostly consumed. Flaming eventually ceases, leaving a mass of glowing embers.

This description of fire growth applies even if the walls and ceiling are noncombustible. In a different scenario, the preflashover stage may entail ignition of a wall or ceiling. For example, a fire may start in a wastepaper basket in a corner of a room lined with combustible wall covering. If the wall is sufficiently flammable, it will catch fire and flames may spread above the wastepaper basket along the corner. If flames reach the ceiling and spread along the upper wall, thermal radiation levels at the floor will likely be sufficient for flashover to occur.

The temperature of the upper gas layer in a room indicates the progression of a room fire; flashover occurs when the temperature of the upper layer reaches 500 to 600°C. Figure IV-2 illustrates the three stages of a room fire. The preflashover stage may last from 5 to 20 minutes, the postflashover stage may last 20 to 40 minutes and the decay stage for more than an hour. (The dashed curve represents fires in which either the first item burns out or the fire becomes starved for oxygen before flashover occurs.) In unsprinklered residential buildings approximately 22% of fires proceed to flashover.<sup>5</sup>

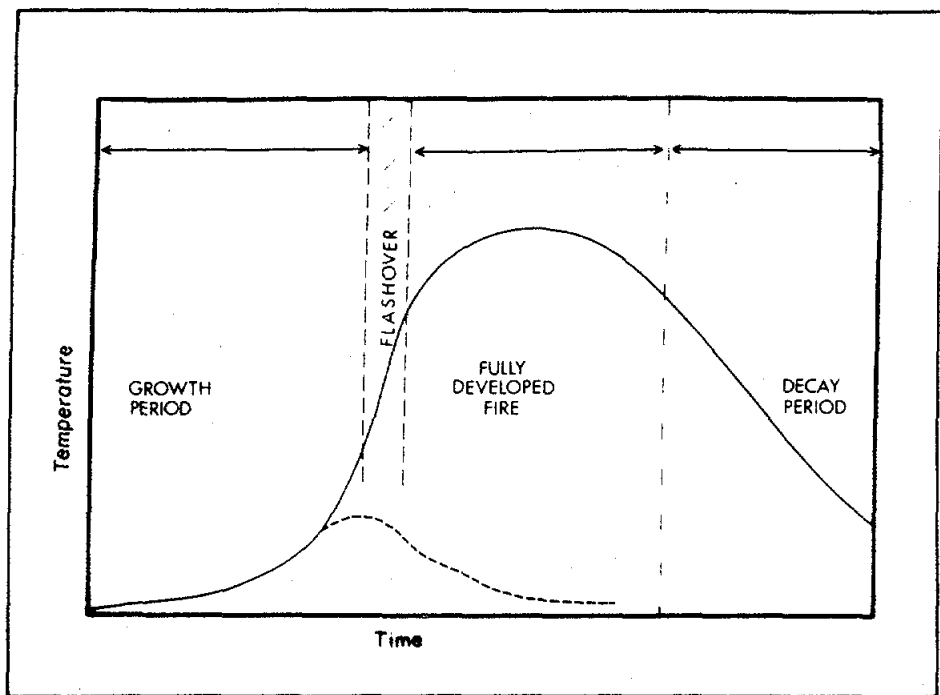

Figure IV-2. The course of a room fire is often monitored based on the upper gas layer temperature in the room.

Copyright by John Wiley and Sons Ltd. Reprinted with permission from *D. Drysdale, "An Introduction to Fire Dynamics"*, J. Wiley and Sons, Chichester, (1985).

## PREFLASHOVER FIRES

Following ignition and during the early stages of fire growth, occupants have an opportunity to take action. They may sound the alarm, evacuate the area or begin suppressing the fire. This opportunity may not last long as conditions within the room deteriorate rapidly. Occupants unable to leave the room of fire origin will perish before flashover occurs, usually as a result of severe thermal exposure.

Temperatures and heat fluxes that are sufficient to ignite combustible solids are too extreme for humans to endure. Consequently, slowing down fire growth or preventing flashover altogether become important fire safety considerations.

In recent years, a great deal of effort has been expended in developing mathematical models to predict the rate of fire growth in rooms and to assess whether (and when) flashover occurs.<sup>6</sup> Such models can also be used to predict the time available to escape before untenable conditions develop. These models offer a cost-effective method for analyzing the impact of material selection or building design on fire safety. A review of such models and a discussion of their strengths, limitations, and availability has been published recently.<sup>7</sup>

Fire models have been used to corroborate and to identify the following factors as significant contributors to preflashover fire growth:

1. The flammability of room contents. The rate at which products release heat as they burn influences the rate of temperature increase of the hot upper layer and hence the time needed for untenable conditions and flashover to develop.
2. The distribution of combustibles within the room. If combustible contents are placed close to one another, fire may spread easily from object to object with a resultant increase in heat release rate until the upper layer temperature becomes hot enough that flashover occurs.
3. The flammability of room linings. The rate at which flames spread across the room linings impacts heat build-up in the room.
4. The thermal properties (thermal conductivity and specific heat) of room linings. A room lining that is a very good thermal insulator causes heat loss from the upper layer to be low and the layer's temperature to climb dramatically, resulting in earlier flashover.
5. The supply of air. In the absence of an open door or window a fire may be smothered in its early stage. Often during a room fire, temperature development is sufficient to break windows and thereby to provide a fresh supply of air.
6. The size and shape of the room. For very large rooms, flashover is an unlikely event as the large surface area of the walls and ceiling extract heat from the upper layer very efficiently. Nonetheless, untenable conditions or reduced visibility may still be experienced early in a fire in a large room.

A number of fire-safety strategies are commonly used to slow down fire growth or to prevent flashover in a room. Examples include the provision of automatic sprinklers, restrictions on the flammability of upholstered furniture, requirements for self-closing doors, and restrictions on the flammability of room lining materials. A complementary strategy is to provide for efficient occupant response by providing early fire detection devices and alarms, and by providing adequate means of egress. Provisions for such strategies are most commonly found in building codes.

## **POSTFLASHOVER FIRES**

Following flashover, a fire generates a great deal of heat and smoke. These can migrate through the building to threaten the lives of occupants far from the room of fire origin. Statistics indicate that, in the United States, most fatalities in fires occur away from the room of fire origin and are the result of smoke inhalation.<sup>8</sup>

Postflashover fires also pose a threat to compartment boundaries and to structural elements. Should either of these fail, fire can spread quickly throughout a building. Consequently, inhibiting fire spread through compartment boundaries and preventing structural collapse in fire are important fire safety considerations.

The severity of a postflashover fire can be quantified in terms of the temperature history of the compartment gases or in terms of the rate at which toxic products of combustion are generated. Much research has been conducted to develop mathematical models to predict the severity of postflashover fires.<sup>6,9</sup> These models offer a cost-effective method for analyzing both the performance of structural elements in the building and the adequacy of protection provided for escape routes.

Fire models have identified the following factors as contributing most significantly to postflashover fire severity:

1. The flammability of room contents and interior finish. The rate at which room contents or interior finish release heat as they burn influences the rate at which the hot gas temperature rises in the room.
2. The quantity of combustibles. In the absence of suppression activities, the quantity of combustibles in the room and the rate of fuel consumption determine the duration of the postflashover stage of the fire. The longer the fire lasts, the more severe is the attack on structural elements in the room.
3. The thermal properties (thermal conductivity and specific heat) of room linings. Lining a room with a good thermal insulator causes heat loss from the hot gases to be low. A room lined with a good insulator experiences a hotter fire than a room lined with a poor insulator. Consequently, a structural element (such as a column) in the center of the room lined with a good insulator experiences a more severe fire than a column in the center of a room lined with a poor insulator.
4. The supply of air (size of openings). Following flashover, windows and doors that are not fire-rated break or collapse. If the openings are small, the rate of reaction (and hence rate of heat release) is governed by the rate that air is supplied and the fire is referred to as ventilation-controlled.
5. The size and shape of the room. In very large rooms, the surface area of the walls and ceiling are large so a great deal of heat can be extracted from the fire gases. Therefore, in principle, such fires are not among the hottest. Nonetheless, because of the sheer volume of flame, they can be difficult to extinguish. Fortunately, flashover is rare in large rooms.

Several fire safety strategies are commonly used to reduce the impact of postflashover fires. Examples include the provision of the following: automatic sprinklers; highly fire-resistant room boundaries and structural elements; wired glass; and smoke-control strategies to deal with the large quantities of smoke generated during a fire. Such provisions are most commonly found in building codes. A complementary, though less common strategy is to reduce the quantity of combustibles in rooms.

## **SMOKE PRODUCTION**

Smoke is defined as the airborne solid and liquid particulates, and fire gases produced when a material undergoes pyrolysis or combustion. The molecular structure of the fuel influences the yield of components such as carbon dioxide, carbon monoxide and soot (carbon) in smoke. For example, for every gram of ethanol consumed in a well-ventilated fire 1.77 grams of CO<sub>2</sub>, 0.001 grams of CO, and 0.008 grams of soot (carbon) are generated. On the other hand, for every gram of polystyrene consumed in a well-ventilated fire 2.33 grams of CO<sub>2</sub>, 0.060 grams of CO, and 0.164 grams of soot (carbon) are generated.<sup>10</sup>

Smoke may obscure visibility and thereby impede evacuation of a building. It also represents a toxic hazard to building occupants. (Toxicity is discussed below.)

During much of the preflashover stage of a fire, the flames are well-ventilated and toxicity is generally not a severe problem. Reduced visibility and burns are, however, serious concerns. Statistics suggest that fatalities associated with preflashover fires are typically in the room of fire origin and result from burns.<sup>8</sup>

Postflashover fires are poorly ventilated. The rates of CO and soot generation can be very high and these products are often transported throughout a building. This may lead to seriously reduced visibility and the possibility of inhalation of toxic products of combustion. Statistics suggest that fatalities associated with postflashover fires typically occur outside the room of fire origin and result from smoke inhalation.<sup>8</sup>

#### Smoke toxicity

A wide variety of fire gases are present in smoke with the toxicants usually classified as chemical asphyxiants or irritants.<sup>11</sup>

Chemical asphyxiants depress the central nervous system, causing loss of consciousness and ultimately death. Effects of asphyxiants depend on exposure concentration and duration. Asphyxiants of most concern in fire are carbon monoxide (CO) and hydrogen cyanide (HCN).

Irritant effects are produced by essentially all fire atmospheres and are of two major types: (1) sensory (eyes and upper respiratory tract) and (2) pulmonary (lungs). Sensory effects, which may impede evacuation, are primarily related to the concentration of the irritant and normally do not increase in severity with time. Pulmonary irritants may cause lung edema and ultimately death, and are determined by species concentration and exposure duration.

#### Toxic fire gases

Extensive investigations of human fire fatalities with respect to exposure to toxic atmospheres have shown CO to be the primary toxicant. Although CO is not the most toxic gas at low concentrations, it is always one of the most abundant toxic gases produced by fires. Recent research has suggested that, for postflashover fires, the yield of CO may depend not so much on the chemical nature of the fuel as on the oxygen available for combustion and the thermal conditions in the flames. Postflashover fires are poorly ventilated and as a general rule, for every gram of fuel consumed as much as 0.20 grams of CO are generated.<sup>12</sup> This is a very high yield.

HCN is produced from the burning of materials containing nitrogen; for example, wool and polyurethane. HCN is about 20 times as toxic as CO but is generally produced in much smaller quantities. Documented cases in which HCN alone is the primary toxicant are rare.

Fire usually produces carbon dioxide, CO<sub>2</sub>, in large quantities in fires. Although it is not particularly toxic, it displaces O<sub>2</sub> and thereby causes the rate and depth of breathing to increase. This often causes an accelerated inhalation of other toxicants and irritants.

Oxygen, O<sub>2</sub>, is consumed during a fire. When it drops from its usual level of 21% in air to 17%, motor coordination is impaired. When it drops into the 10%-14% range, a person may exercise faulty judgement and be fatigued quickly. When it drops into the 6%-10% range, a person loses consciousness and must be revived with fresh air or O<sub>2</sub> within a few minutes to prevent death.

Acrolein is a potent irritant, both in terms of sensory and pulmonary functions. It is formed during the smoldering of cellulose and the pyrolysis of some plastics.

Hydrogen chloride (HCl), formed from the combustion of chlorine-containing materials such as polyvinyl chloride (PVC), is a potent sensory irritant and a strong pulmonary irritant.

### Toxic potency

Smoke contains several toxicants. The lethal toxic potency of smoke produced by a burning material is expressed in terms of its  $LC_{50}$ . The  $LC_{50}$  is the concentration that causes the death of 50% of test rodents within a specified exposure (usually 30 minutes) and post-exposure time (usually 14 days).

Several small-scale tests have been devised to determine toxic potencies. No single test is appropriate for all materials under all fire exposures. Unfortunately, small-scale tests often generate less CO per unit mass of material consumed than that found in real fires. Thus the  $LC_{50}$  must often be adjusted for use in hazard calculations. Much research is still required before a validated method is available to predict the toxic hazard in real-world fires on the basis of toxic potencies determined in small-scale tests.

### REFERENCES

1. Rockett JA, Milke JA [1995]. Conduction of heat in solids. In: SFPE handbook of fire protection engineering. 2nd ed. Ed by DiNenno PJ, Beyler CL, Custer RLP, Walton WD, Watts JM Jr, Drysdale D and Hall JR Jr. Quincy, MA: National Fire Protection Association, p. 1-25, Chapter 1-3.
2. Atreya A [1995]. Convection heat transfer. In: SFPE handbook of fire protection engineering. 2nd ed. Ed by DiNenno PJ, Beyler CL, Custer RLP, Walton WD, Watts JM Jr, Drysdale D and Hall JR Jr. Quincy, MA: National Fire Protection Association, p. 1-39, Chapter 1-3.
3. Tien CL, Lee KY, Stretton AJ [1995]. Radiation heat transfer. In: SFPE handbook of fire protection engineering. 2nd ed. Ed by DiNenno PJ, Beyler CL, Custer RLP, Walton WD, Watts JM Jr, Drysdale D and Hall JR Jr. Quincy, MA: National Fire Protection Association, p. 1-65, Chapter 1-4.
4. Drysdale D [1985]. An introduction to fire dynamics. Chichester, UK: John Wiley and Sons.
5. Mehaffey JR [1987]. Flammability of building materials and fire growth. In: Designing for fire safety: the science and its application to building codes. Canada: National Research Council Canada, NRCC 28277, pp. 21-33.
6. Walton WD [1995]. Zone computer fire models for enclosures. In: SFPE handbook of fire protection engineering. 2nd ed. Ed by DiNenno PJ, Beyler CL, Custer RLP, Walton WD, Watts JM Jr, Drysdale D and Hall JR Jr. Quincy, MA: National Fire Protection Association, p. 3-148, Chapter 3-7.
7. Friedman R [1992]. An international survey of computer models for fire and smoke. *J Fire Prot Eng* 4:83-92.
8. Hall JR [1996]. Whatever happened to combustion toxicity. *NFPA J Nov-Dec*:91-101.
9. Walton WD, Thomas PH [1995]. Estimating temperatures in compartment fires. In: SFPE handbook of fire protection engineering. 2nd ed. Ed by DiNenno PJ, Beyler CL, Custer RLP, Walton WD, Watts JM Jr, Drysdale D and Hall JR Jr. Quincy, MA: National Fire Protection Association, p. 3-134, Chapter 3-6.
10. Tewarson A [1995]. Generation of heat and chemical species in fires. In: SFPE handbook of fire protection engineering. 2nd ed. Ed by DiNenno PJ, Beyler CL, Custer RLP, Walton WD, Watts JM Jr, Drysdale D and Hall JR Jr. Quincy, MA: National Fire Protection Association, p. 3-53, Chapter 3-4.



11. Hartzell G [1992]. Combustion products and their effects on life safety. In: Fire protection handbook. 17th ed. Ed by Cote A and Linville J. Quincy, MA: National Fire Protection Association, p. 3-3, Chapter 3-1.
12. Babrauskas V [1992]. The generation of CO in bench-scale fire tests and the prediction for real-scale fires. In: Proceedings of the 1st International Fire and Materials Conference, September 24-25. Ed by Grayson SJ. Washington, DC: pp. 155-178.

#### SAMPLE QUIZ QUESTIONS

1. Suppose a gasoline spill, that has been contained within a circular dyke of diameter 2.0 m, is accidentally set on fire. The rate at which heat is released within the flames is about 6,800 kW. The height of the flames is about 6.0 m. For gasoline fires, roughly 30% of the total heat released is radiated away from the flames.
  - a) Calculate the radiant heat flux ( $\text{kW m}^{-2}$ ) arriving at a point 6.0 m from the center of the flame. Assume by the time you are 6.0 m away from the flame that the flame can be pictured as a point source of radiation and that radiation is emitted uniformly in all directions.
  - b) Using data presented in Table IV-2, determine whether wood stored 6.0 m from the flame center will be ignited if the fire is allowed to burn for 15 min or more.
2. Glass typically begins cracking and breaking when exposed to fire gases at temperature  $300^{\circ}\text{C}$ . Pure aluminium melts at  $660^{\circ}\text{C}$ .
  - a) Would you expect the glass in windows to break before or after a room fire experiences flashover?
  - b) Would you expect the aluminium window frames to melt before or after a room fire experiences flashover?
3. Consider a short massive wooden column of cross section 300 mm by 300 mm. When exposed in a post-flashover fire, wood typically chars at a rate of about 0.6 mm/min. Assume that before the fire, the column was loaded to 1/3 of its ultimate (compressive) strength. As the fire proceeds, the cross-sectional area of the column is reduced so that its compressive strength is also reduced. At what point in the fire will the cross-sectional area of the column have been reduced to 1/3 of its original area so that the column will fail?
4. A computer monitor containing 1 kg of polypropylene (PP) burns in an airtight room with dimensions 10 m x 10 m x 3 m. Assume the smoke and air are mechanically mixed by a fan. Under these conditions, ample air is in the room to completely burn the PP, and for every gram of PP consumed, 0.024 grams of CO are generated.
  - a) Estimate the volumetric fraction of CO in the room. Assume the molecular weight of a typical air molecule is 28.95. Assume that before the fire, the air was at temperature  $20^{\circ}\text{C}$  and had density  $1.2 \text{ kg m}^{-3}$ .
  - b) Calculate the maximum time occupants can remain in the room without becoming incapacitated. The time is given by  $t = 35,000 / V_{\text{CO}}$  where t is time in minutes and  $V_{\text{CO}}$  is volumetric fraction of CO in ppm (parts per million).

**Unit V**  
**PRINCIPLES OF FIRE PROTECTION**

**PURPOSE:** To describe the practice of fire protection including the role of codes and standards.

**OBJECTIVES:** To acquaint the reader with:  
1. The scope of fire protection issues  
2. Integrated fire safety design

**SPECIAL TERMS:**

1. Fire Safety Concepts Tree (NFPA 550)
2. Fire safety objectives
3. Fire prevention codes
4. Building codes
5. Compartmentation
6. Structural protection
7. Fire detection
8. Fire suppression
9. Escape routes

## INTRODUCTION

As mentioned in Unit I, two basic types of codes address fire safety: building codes and fire prevention codes. Building codes provide a set of fire safety provisions intended to ensure that an acceptable level of life safety is incorporated into buildings at the time of their construction. Fire prevention codes spell out a set of provisions intended to ensure that, following construction, buildings are equipped, operated and maintained to provide an acceptable level of life safety and property protection from potential hazards created by fires or explosions. Both building codes and fire prevention codes make reference to numerous other fire safety codes and standards.

Regulations entail a "hierarchy" of codes and standards. The provision of fire safety can be viewed as an effort to comply with regulations. Strict adherence to regulations without an understanding of relationships among fire safety measures and their roles in meeting fire safety objectives can yield a fragmented approach to design. A facility in which the escape routes, structural components, alarm system, sprinkler system, smoke-control system, etc. have been designed independently of one another may comply with regulations, but this arrangement is unlikely to be operationally or economically efficient.

## FIRE SAFETY CONCEPTS TREE

In this Unit, an integrated method for delivering fire safety is presented based on NFPA's Fire Safety Concepts Tree (FSCT).<sup>1</sup> The FSCT provides a conceptual framework by which the various fire safety requirements found in regulations work together to achieve fire safety objectives. Application of the framework can identify options, gaps and redundancies in fire protection strategies. A discussion of how the FSCT is structured is presented below, followed by practical examples of its use.

### Fire safety objectives

As mentioned in Unit II, when undertaking a fire safety analysis of a facility it must be clear whether the objective of the analysis is to ensure life safety, property protection, minimal disruption to business or some combination of these. The uppermost level of the FSCT depicted in Figure V-1 acknowledges that the ultimate purpose of the exercise is not just to comply with regulations, but to meet specific fire safety objectives.

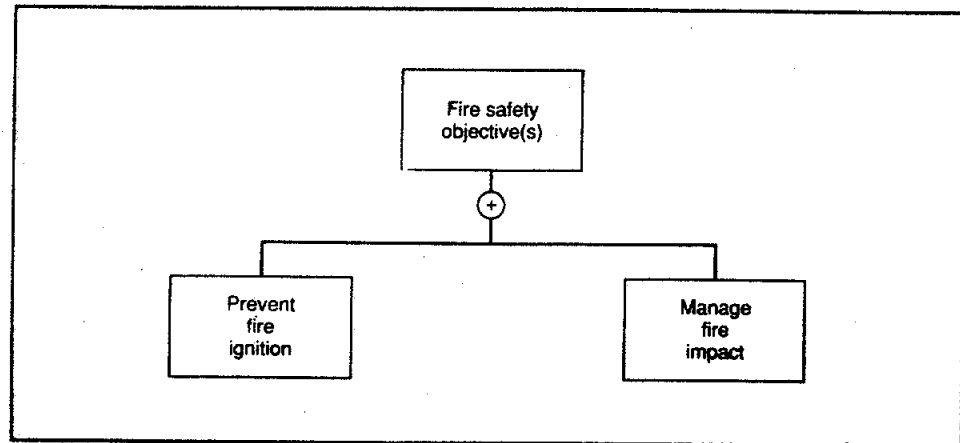

Figure V-1. The Fire Safety Concepts Tree identifies two ways to achieve fire safety objectives: PREVENT FIRE IGNITION or MANAGE FIRE IMPACT.

Reprinted with permission from NFPA 550, *Fire Safety Concepts Tree*, Copyright © 1995, National Fire Protection Association, Quincy, MA 02269. This reprinted material is not the complete and official position of the National Fire Protection Association, on the referenced subject which is represented only by the standard in its entirety.

Two strategies are identified in Figure V-1 for achieving fire safety objectives: PREVENT FIRE IGNITION or MANAGE FIRE IMPACT. These strategies are connected to the fire safety objectives by an "or gate" (a plus sign within a circle). Fire safety objectives can be met by preventing ignition or by managing the impact of fire. To provide an extra measure of security, both strategies are commonly used.

**Prevent fire ignition**

The PREVENT FIRE IGNITION branch of the tree (see Figure V-2) includes measures that are most typically found in fire prevention codes such as NFPA 1<sup>2</sup>. In general, the branch puts forward provisions related to how facilities are equipped, operated and maintained following construction.

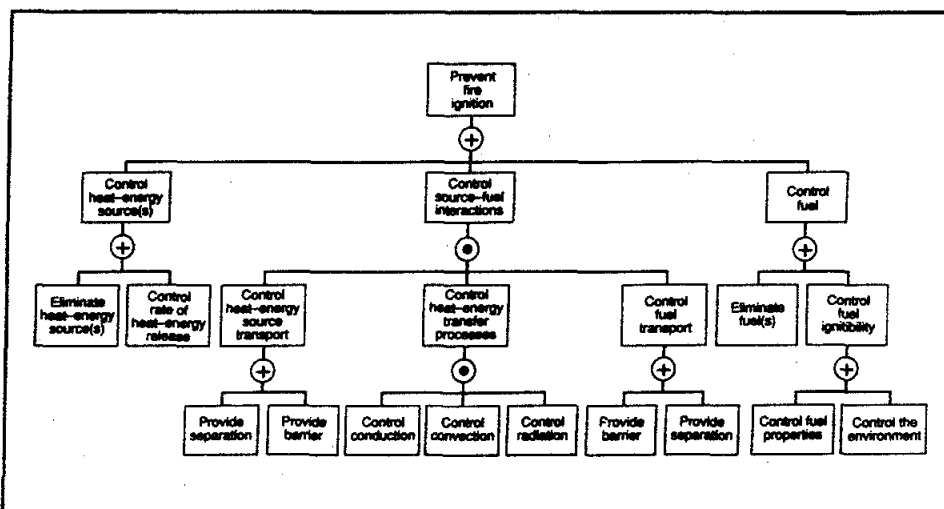

Figure V-2. PREVENT FIRE IGNITION Branch of the Fire Safety Concepts Tree.

Reprinted with permission from NFPA 550, *Fire Safety Concepts Tree*, Copyright © 1995, National Fire Protection Association, Quincy, MA 02269. This reprinted material is not the complete and official position of the National Fire Protection Association, on the referenced subject which is represented only by the standard in its entirety.

Suppose that a commercial laboratory proposes to use small quantities of an organic solvent during chemical analysis tests. The laboratory would like to take appropriate steps to ensure that the organic solvent is unlikely to be ignited so its use would not pose an undue risk to laboratory technicians. Figure V-2 presents three strategies to PREVENT FIRE IGNITION.

1). CONTROL FUEL by the following methods:

a. ELIMINATE FUEL by selecting a nonorganic solvent such as water if such a choice is compatible with the chemical analysis

b. CONTROL FUEL IGNITABILITY

i. CONTROL FUEL PROPERTIES by choosing the least flammable organic solvent compatible with the chemical analysis. For example,

suppose three organic solvents are acceptable for the application: acetone ( $C_3H_6O$ ), benzene ( $C_6H_6$ ) or monochlorobenzene ( $C_6H_5Cl$ ). Acetone has a flash point of  $-18^\circ C$  and a boiling point of  $56^\circ C$ , so according to Figure III-2 it is a Class IB flammable liquid. Benzene has a flash point of  $-11^\circ C$  and a boiling point of  $80^\circ C$  so it is only moderately better than acetone with respect to its ignitability. Monochlorobenzene which has a flash point of  $32^\circ C$  and a boiling point of  $132^\circ C$  is a Class IC flammable liquid and hence it is the least hazardous of the three.

ii. CONTROL THE ENVIRONMENT by carrying out the whole procedure in a fume hood or in a compartmented area. Fans could remove the solvent vapors rapidly enough so that the vapor/air mixture always remains below its lower flammability limit.

2). CONTROL HEAT-ENERGY SOURCES by the following methods:

a. ELIMINATE HEAT-ENERGY SOURCES from the area in which the tests are conducted. For example, if the most likely ignition source is sparks generated by electrical equipment, such equipment could be prohibited near the test area.

b. CONTROL RATE OF HEAT RELEASE (or the intensity of electrical sparks) by choosing properly grounded electrical equipment that has been approved for areas where combustible vapor/air mixtures may be found.

3). CONTROL SOURCE-FUEL INTERACTIONS by the following methods:

a. CONTROL HEAT-ENERGY SOURCE TRANSPORT

b. CONTROL HEAT-ENERGY TRANSFER PROCESSES

c. CONTROL FUEL TRANSPORT

These strategies are connected through an "and gate" (a dot within a circle). Thus the decision tree implies that all three strategies must be applied simultaneously to control source-fuel interactions. Methods to ensure that these three strategies are achieved are identified in lower levels of the tree (Figure V-2).

At the lowest level of the tree, it is indicated that it may be possible to PROVIDE SEPARATION between the fuel and ignition sources by ensuring that the solvent is stored in a cabinet that is isolated from all potential ignition sources.

This example demonstrates how the FSCT can be used to generate several options for minimizing the fire risk posed by the use of an organic solvent in a commercial laboratory setting. Many of the provisions developed in this example are specified in the NFPA's Flammable and Combustible Liquid Code, NFPA 30<sup>3</sup>.

**Manage fire impact**

Figure V-3 presents the MANAGE FIRE IMPACT side of the tree. This is a type of loss control strategy whereby it is acknowledged that fire will be ignited and attempts are made to limit the magnitude of the fire hazard or to minimize the effects. MANAGE FIRE IMPACT has two major branches, MANAGE FIRE and MANAGE EXPOSED.

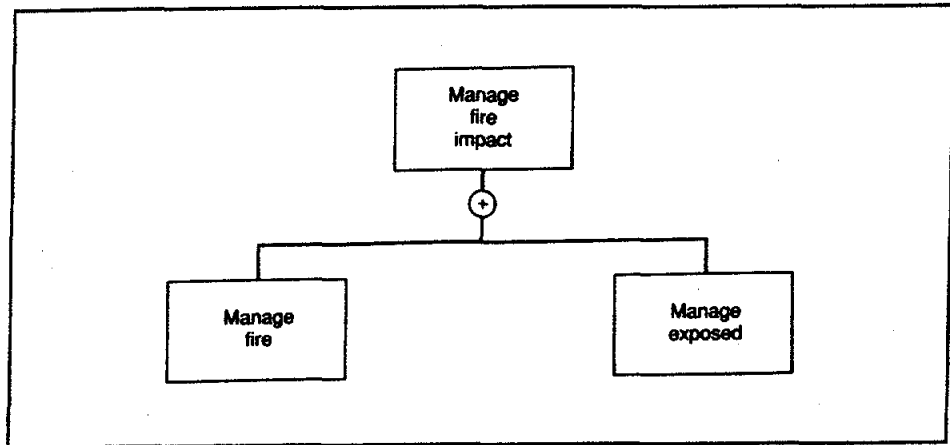

Figure V-3. Two strategies are identified to MANAGE FIRE IMPACT: MANAGE FIRE and MANAGE EXPOSED.

Reprinted with permission from NFPA 550, *Fire Safety Concepts Tree*, Copyright © 1995, National Fire Protection Association, Quincy, MA 02269. This reprinted material is not the complete and official position of the National Fire Protection Association, on the referenced subject which is represented only by the standard in its entirety.

1). The MANAGE FIRE branch is depicted in Figure V-4. It contains a variety of strategies directed toward reducing the hazards associated with fire growth and spread. Examples of how some of these strategies are reflected in the provisions of building codes follow.

- a. CONTROL COMBUSTION PROCESS is a goal of building codes.
  - i. Codes CONTROL FUEL by regulating interior finish on the basis of its
    - A. flame-spread rating (CONTROL FUEL PROPERTIES)
    - B. thickness (LIMIT FUEL QUANTITY)
    - C. location within a facility (CONTROL FUEL DISTRIBUTION)
  - ii. Although building codes do not contain provisions to CONTROL THE ENVIRONMENT, fire prevention codes do. (See page V-4.)
- b. SUPPRESS FIRE. In some buildings, automatic sprinklers are required to slow down the rate of fire growth and to reduce the likelihood of fire spreading from the compartment of fire origin. Automatic detection systems (DETECT FIRE) are required to active the suppression system.
- c. CONTROL FIRE BY CONSTRUCTION is a central theme of building codes.
  - i. Codes CONTROL MOVEMENT OF FIRE in two ways:
    - A. CONFINE/CONTAIN FIRE (Compartmentation). This measure entails subdividing a building into compartments separated from one another by fire resistant barriers. The intent is to confine fire to the

compartment of origin and to keep fire from entering escape routes.  
 B. VENT FIRE. This measure is intended to exhaust the heat and smoke produced in a fire from the building.

ii. Codes PROVIDE STRUCTURAL STABILITY. Structural fire protection requirements are intended to prevent collapse of buildings exposed to fire. In most buildings, structural elements must exhibit prescribed levels of fire resistance. In addition, in many large buildings, structural elements must be constructed of noncombustible materials.

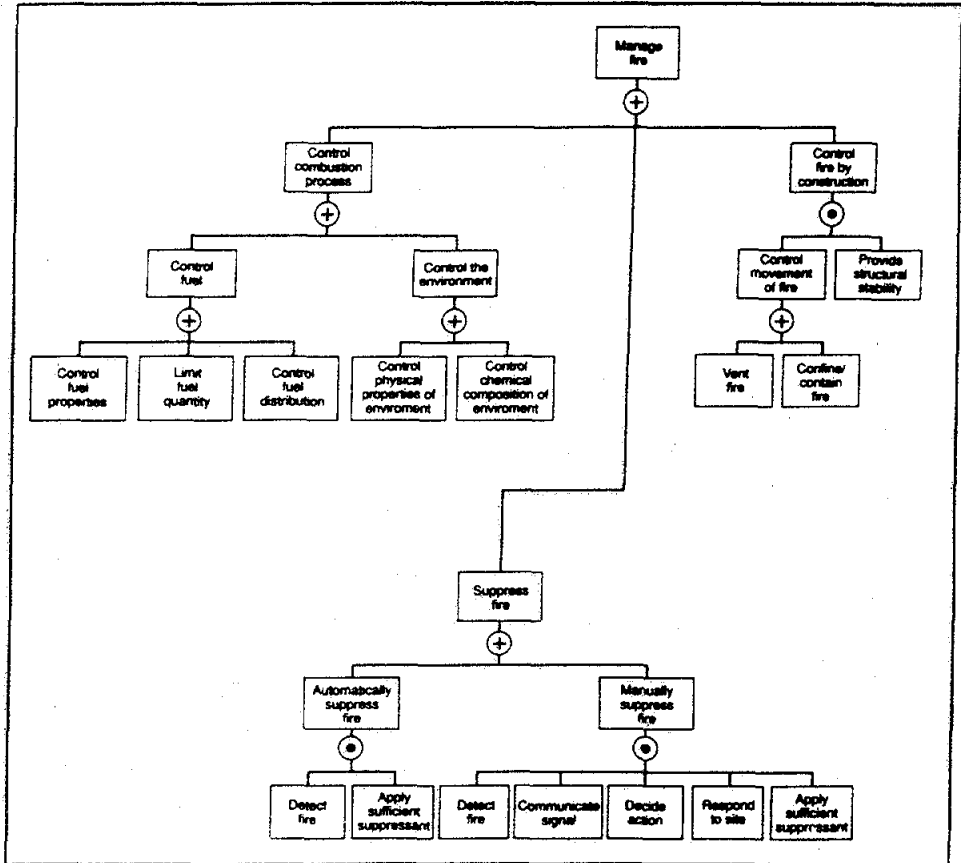

Figure V-4. The MANAGE FIRE branch of the FSCT.

Reprinted with permission from NFPA 550, *Fire Safety Concepts Tree*, Copyright © 1995, National Fire Protection Association, Quincy, MA 02269. This reprinted material is not the complete and official position of the National Fire Protection Association, on the referenced subject which is represented only by the standard in its entirety.

2). The MANAGE EXPOSED branch of the tree shown in Figure V-3 is depicted in detail in Figure V-5. For applications where life safety is the primary objective, this branch is particularly important as it contains strategies directed towards protecting people. Examples are provided below of how these strategies are reflected in building codes and how more specific details are given in the lower levels of the tree.

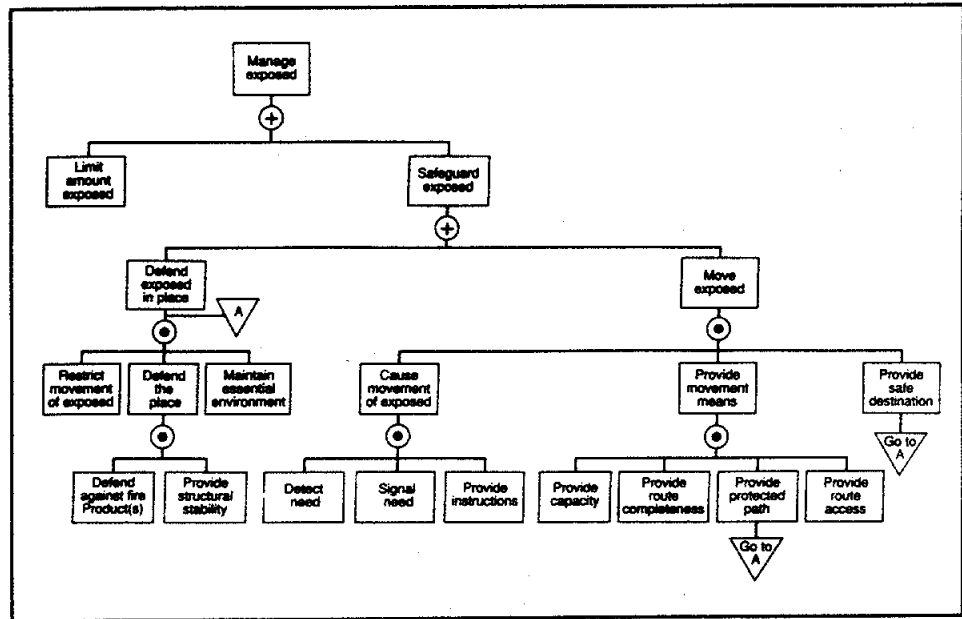

Figure V-5. The MANAGE EXPOSED branch of the FSCT.

Reprinted with permission from NFPA 550, *Fire Safety Concepts Tree*, Copyright © 1995, National Fire Protection Association, Quincy, MA 02269. This reprinted material is not the complete and official position of the National Fire Protection Association, on the referenced subject which is represented only by the standard in its entirety.

a. SAFEGUARD EXPOSED. Building codes contain requirements intended to protect building occupants by:

i. MOVE EXPOSED. Facilitate evacuation in the event of fire.

A. CAUSE MOVEMENT OF EXPOSED. To initiate evacuation building codes require:

- (1) automatic detection: DETECT NEED
- (2) an alarm system: SIGNAL NEED
- (3) a fire safety plan: PROVIDE INSTRUCTIONS

The intent here is to ensure occupants are warned of the fire and that they begin to evacuate before hazardous conditions develop.

B. PROVIDE MOVEMENT MEANS. Codes protect occupants by providing adequate escape routes.

- (1) PROVIDE CAPACITY. These routes must be wide enough to accommodate evacuating personnel.
- (2) PROVIDE ROUTE COMPLETENESS. They must not open into high hazard areas.
- (3) PROVIDE PROTECTED PATH. They must be free of smoke and fire.



(4) PROVIDE ROUTE ACCESS. They must be accessible from all areas of the building.

The intent is to ensure that occupants have safe routes to evacuate a building involved in fire.

### C. PROVIDE SAFE DESTINATION

ii. DEFEND IN PLACE. For some buildings, such as hospitals, building codes include requirements that ensure patients are safe from the effects of fire even if they cannot be moved.

b. LIMIT AMOUNT EXPOSED. Building codes contain requirements that restrict the number of occupants present in various sections a building to ensure that escape routes are not overwhelmed.

A discussion of the utility of the FSCT as a design tool follows in the next section.

## THE PROVISION OF FIRE SAFETY

Fire protection engineers commonly address fire (life) safety concerns by demonstrating compliance with fire prevention and building code requirements. These requirements are prescriptive and structured to make design and enforcement simple yet effective. Prescriptive requirements tend to provide detailed descriptions of how to undertake fire safety design, but they do not spell out the specific objectives of each requirement. The Fire Safety Concepts Tree provides the fire protection engineer with a simple method for appreciating how these assorted requirements work together to ensure fire safety. Information gained from the FSCT may also be used to conceptualize and provide an overall structure to the design process itself.

As stated in Unit I, codes and standards are being revised to encourage performance-based design in which fire safety is provided by matching the solution to the hazard. The use of computer software will soon become common to model the spread and severity of fire in a building as well as the response of building occupants, building components and fire protection systems. Such developments are opening the door for engineered fire safety solutions as an alternative to prescriptive solutions. Engineered solutions may yield more cost-effective and flexible design alternatives than prescriptive solutions. Clearly, such design can only be undertaken by a well trained fire protection engineer. The Fire Safety Concept Tree provides a means by which the fire protection engineer can identify options, gaps and redundancies in alternative fire protection strategies under consideration.

### REFERENCES

1. NFPA [1995]. NFPA 550, Guide to the fire safety concepts tree. Quincy, MA: National Fire Protection Association, 16 p.
2. NFPA [1992]. NFPA 1, Fire prevention code. Quincy, MA: National Fire Protection Association, 130 p.
3. NFPA [1993]. NFPA 30, Flammable and combustible liquid code. Quincy, MA: National Fire Protection Association, 75 p.

### **SAMPLE QUIZ QUESTIONS**

1. A building products manufacturer wishes to construct a new 2-storey office building. The company wishes to use one of its new products as the interior finish in a small meeting room in the proposed building. This product is moderately more flammable than building regulations permit. As currently designed, the room will meet all exiting requirements and will be equipped with a heat detector as required. The only noncompliant feature would be the interior finish. Use the Fire Safety Concepts Tree to recommend other design choices that might yield an equivalent level of safety as that required by regulations.
2. Suppose you have been asked to design the fire protection features for a high-security prison. In the event of fire, you have been told that it is not feasible to simply allow prisoners the freedom to escape along unsecured exit routes. Use the **MANAGE EXPOSED** branch of the Fire Safety Concepts Tree to devise a strategy which may be used to ensure safety of prisoners, but without causing a security risk.



**Unit VI**  
**FIRE DETECTION**

**PURPOSE:** To familiarize the reader with the basics of fire detection.

**OBJECTIVES:** To present aspects of fire detection including:  
1. The theory of detection  
2. Compatibility of the detection system with the hazard

**SPECIAL TERMS:**

1. Fire alarm systems
2. Fire signatures
3. Aerosol detectors
4. Heat detectors
5. Flame detectors
6. Gas sensing detectors
7. Fire alarm code

## **INTRODUCTION**

The sooner that occupants of a building are warned about the presence of a fire, the more time they have to escape and take action to protect life or property. Likewise, fire departments should be notified as quickly as possible so that they can begin their rescue and suppression activities. As discussed in Unit IV, if a room fire reaches flashover, evacuation and fire fighting become much more difficult with a higher degree of danger.

In this unit, the basis of fire detection and some general functions of fire alarm systems are presented. Only general principles are introduced, as a detailed discussion of the issues related to fire detection and alarm systems is beyond the scope of this module. Nonetheless, specific references are cited that contain detailed information.

## **FIRE ALARM SYSTEMS**

Building codes, occupational standards, insurance carriers, and the specific needs of building owners may require fire alarm systems to perform diverse functions such as:

1. warning occupants of the presence of a fire
2. alerting fire departments of the presence of a fire
3. indicating the location of a fire by means of a control panel
4. automatically closing fire doors or dampers to ensure good compartmentation
5. automatically closing electrical circuits or gas lines
6. initiating automatic suppression or smoke-control systems
7. activating emergency lighting.

In a large or specialized facility, a fire alarm system may be complex with several basic components including:

1. detection devices (including manual devices)
2. alarms (these sound within the building but may also communicate remotely with fire departments)
3. alarm indicating devices to direct the fire services to the location of the fire within the building
4. a control panel to allow fire services to activate, deactivate or monitor devices connected to the overall system.

Because of the complexity of fire alarm systems, stringent requirements must be met to ensure proper design, installation, commissioning, inspection, maintenance and testing of the entire system.

## **DETECTION DEVICES**

The sequence of events in fire alarm signaling begins with detection. Therefore, detection devices must be properly installed, inspected, maintained and tested. Detection devices must first be selected to be compatible with the anticipated fire hazard; that is, the selected device must be able to detect the presence of fire before untenable conditions develop. Detection devices can be categorized according to the "fire signature" that the device senses.

### **Fire signature**

A "fire signature" is an identifiable change in the local environment caused by a fire. Examples of fire signatures are the appearance of specific amounts and types of aerosols, the presence of convected and radiated heat, and the appearance of gases evolved by a fire. Detection systems are designed to identify one or more of these changes in the environment. As fires involving different fuels may generate different fire signatures, a detection device must be chosen to respond to the expected hazard (fire). An effective operational choice of detection devices depends on the expected fire signatures, the response times of appropriate devices and the minimization (or elimination) of false alarms.

A discussion follows of fire signatures commonly used in detection systems and an overview of devices used to detect these signatures. Following that is a discussion of practical considerations associated with operation and maintenance of detection systems.

### Aerosol detectors

Aerosols include both solid and liquid particulates present in smoke. The size of aerosols associated with combustion ranges from  $<0.001 \mu\text{m}$  to  $10 \mu\text{m}$  and depends on the materials being heated, the rate of heating, the agglomeration of small airborne particles, and the settling characteristics of the aerosols. The range of most aerosols in fires is between  $0.1 \mu\text{m}$  and  $1.0 \mu\text{m}$ . Size of aerosols plays an important role in the choice of detection systems. For example, if light scattering is used as a means by which to measure aerosols, then particles with diameters  $>0.3 \mu\text{m}$  would be detected since these particulates have the ability to scatter light whereas smaller particles are usually referred to as "invisible" because of their inability to scatter light.

The most common types of aerosol or smoke detectors are based on light obscuration, light scattering or electrical conductivity of ionized air. These devices are characterized by rapid detection of aerosols; therefore, they are useful for life-safety concerns.

Light obscuration devices use a light source collimated to fall on a photosensitive device (see Figure VI-1). The signal detected on the sensing device is reduced when aerosols interfere with light transmission between the light source and detector. When a preset level of reduction is sensed, an alarm can be sounded. With these devices, the possibility exists that dusts as well as products of combustion can cause light intensity reductions at the sensing device. Light obscuration devices can be contained within a small unit or they can operate using beams of light projected over large distances.

In light scattering devices used to detect aerosols, the photosensing devices are placed so that they receive no incident light when no aerosols are present in the air. However, when aerosols of appropriate size are present, light will be scattered, fall on the photosensing device, and set off warning systems.

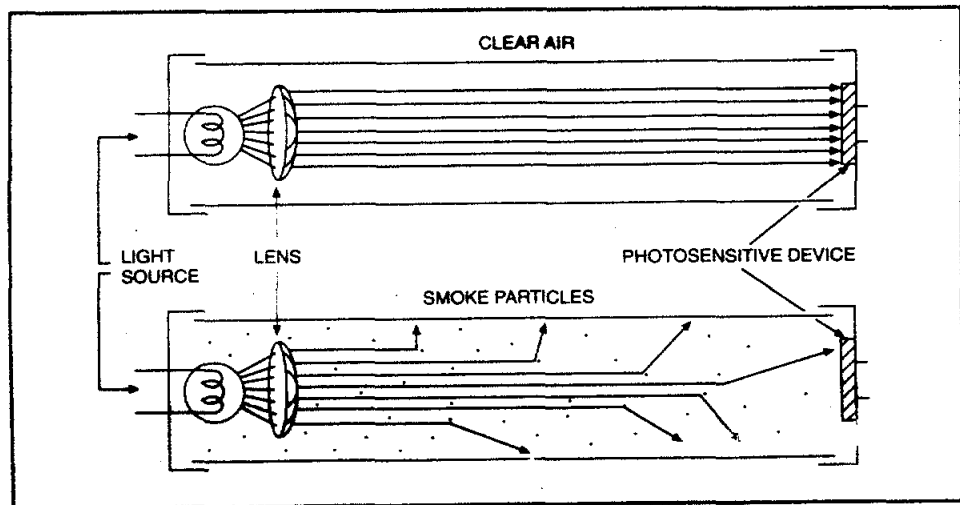

Figure VI-1. Light obscuration detector.

Reprinted with permission from *Fire Alarm Signaling Systems, 2nd Ed.*, Copyright © 1994, National Fire Protection Association, Quincy, MA 02269.<sup>1</sup>

Ionization smoke detectors use radioactive materials to ionize the air between electrically charged electrodes (see Figure VI-2). Ionized molecules of air migrate to the oppositely charged electrodes thereby creating an electrical current. Aerosols attach to ionized air molecules slowing their movement with a subsequent diminution of the electrical conductivity between the electrodes. When the current is reduced below a preset value, the detection device initiates alarms. New models of ionization smoke detectors have dual chambers. One chamber is sealed off from the external environment and the other is exposed to air that may contain products of combustion. The first chamber acts as a reference and imbalances between the current in the two chambers become the electrical signal that activates alarms or other devices. Typical application of these detectors is in areas where fast response is required. However, problems related to dusty conditions or normal operations such as cooking or industrial operations may interfere with smoke detection and render this type of device unsuitable.

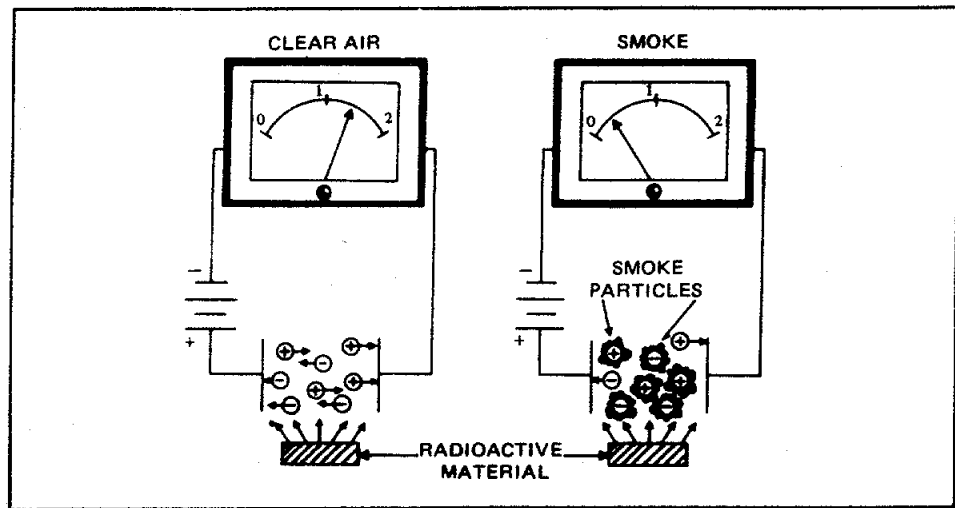

Figure VI-2. Ionization smoke detector.

Reprinted with permission from *Fire Alarm Signaling Systems, 2nd Ed.*, Copyright © 1994, National Fire Protection Association, Quincy, MA 02269.<sup>1</sup>

## Heat detectors

Heat detectors are the most frequently used automatic fire detection devices. Typically they are located under the ceiling in a room and are often the triggering devices for sprinklers. While heat detectors are generally inexpensive, they rely on convected heat for activation. Consequently, their response is slower than aerosol detectors. Activation occurs when a critical component of the device reaches a specific temperature or a specific rate-of-change of temperature. Fixed temperature heat detectors experience thermal lag between the environmental temperature and the detector. Even though the air temperature may have reached a preset value at which device activation is anticipated, a time delay is associated with heating the detector to that temperature.

The most commonly used heat detector is the soldered link in a levered automatic water sprinkler as shown in Figure VI-3. As long as the solder remains solid it maintains the pressurized water in a sealed, nonflow condition. When exposed to high temperatures, the solder liquefies, the links are no longer held together, the levers that maintain the cap and gasket arrangement in position are blown away and the pressurized water escapes

from its piping. The water is ejected into the deflector and is sprinkled around the surrounding area. Other types of heat detectors use spring loaded electrical contacts that are fixed in an open circuit until a preset temperature is reached, whereupon the solder liquefies and the spring forces the contacts into a completed circuit. Once the circuit is completed an electrical signal is generated that can activate an alarm or start a suppression system. The temperature at which these types of devices are activated depends on the composition of the solder (i.e. the solid-liquid transition temperature). The temperature rating of a heat detector is the temperature at which the device is activated (recall that because of thermal lag, the air temperature is greater than the temperature of the device). Common detection devices have a rated temperature of approximately 135°F (57°C); however, higher and lower rated devices are available.

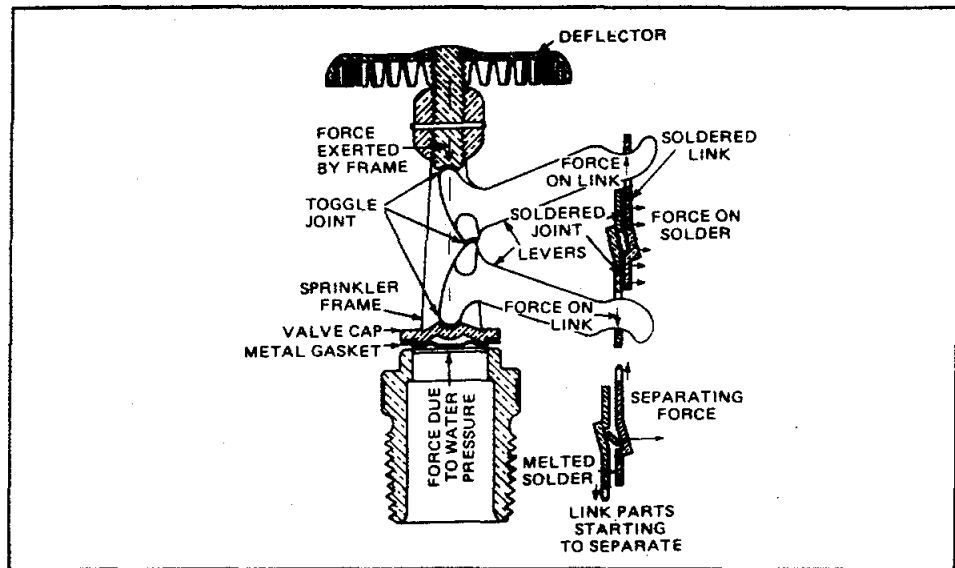

Figure VI-3. Soldered link automatic sprinkler.

Reprinted with permission from *Fire Alarm Signaling Systems, 2nd Ed.*, Copyright © 1994, National Fire Protection Association, Quincy, MA 02269.<sup>1</sup>

To overcome the time lag associated with such detectors and sprinklers, fast response sprinklers that have a high level of thermal sensitivity have been developed. Sprinkler response can be characterized by the speed at which heat can be absorbed from its surroundings in a sufficient amount to result in activation of the system.

The characteristics of thermal expansion of bimetallic strips are also used to activate heat detecting devices. When heated, the two dissimilar metals with different thermal expansion properties cause the strip to bend. This deformation can be used to complete an electrical circuit and thereby signal a temperature rise in the detector environment. Several variations of bimetallic detectors are in use. Other heat detecting devices that rely on thermal expansion of metals in a rate controlled manner are also available.

Line heat detectors are constructed of two conducting wires wrapped in an insulating material. These are braided to promote good contact and then covered by an outer protective coating. The wires remain in an open circuit under normal conditions. When



the temperature around this device is raised, a preset point is reached at which the heat sensitive insulating material melts allowing the two conducting wires to make contact and initiate a signal.

To take advantage of the rapid temperature increase associated with flaming fires that cannot be sensed by these devices, rate-of-temperature rise detectors have been developed. With these devices, fires can be sensed more rapidly than with devices that monitor only the absolute value of temperature. Figure VI-4 shows a line rate-of-rise detector. Under normal conditions and normal fluctuations in temperature, air transfer through the orifices compensates for expansion of the air in the tubing and air chamber. However, these orifices are sized so that for temperature rises of approximately  $7^{\circ}\text{C}/\text{min}$ , release of air through these vents is restricted and the volume of the air expands in the tubing and air chamber. This expansion forces diaphragms to contact and complete an electrical circuit thereby initiating alarms.

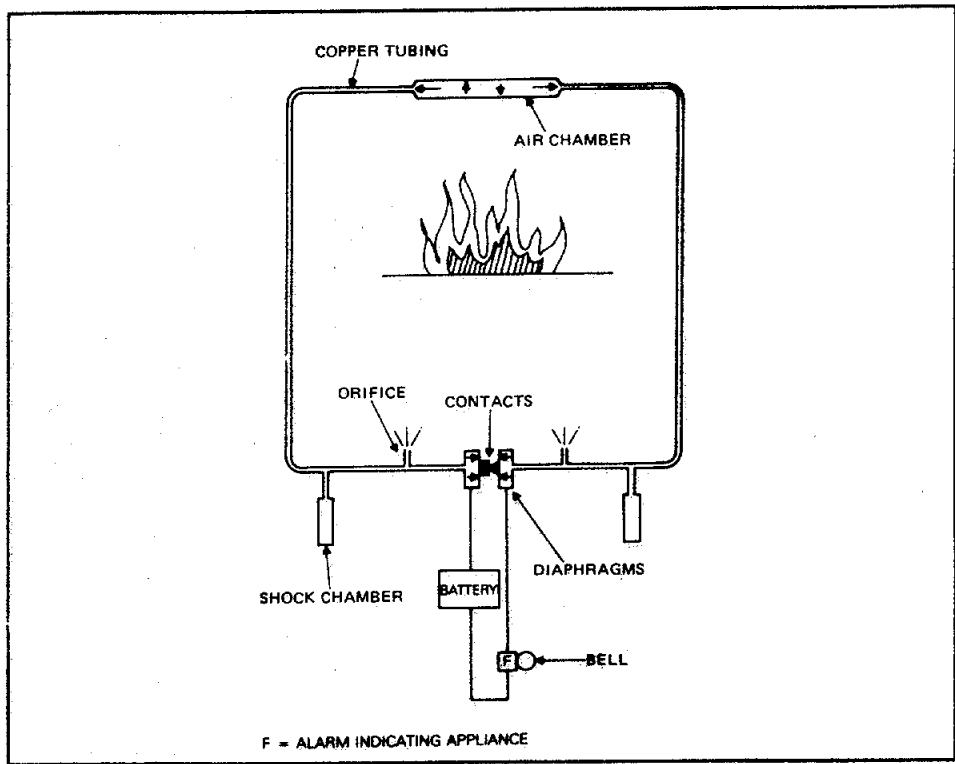

Figure VI-4. Line rate-of-rise heat detector.

Reprinted with permission from *Fire Alarm Signaling Systems, 2nd Ed.*, Copyright © 1994, National Fire Protection Association, Quincy, MA 02269.<sup>1</sup>

Using a heat detection device that incorporates more than one of these detection strategies has become common. A combined fixed temperature and rate-of-rise device is shown in Figure VI-5. The device senses temperature by deflection of a bimetallic strip and the rate-of-rise of temperature by the rate of gas expansion in the air chamber. Such devices can be set to respond to "either" or "and" commands. That is, they can initiate further

action such as an alarm when either the fixed temperature or the rate-of-rise device is triggered, or they can initiate action only when both are activated.

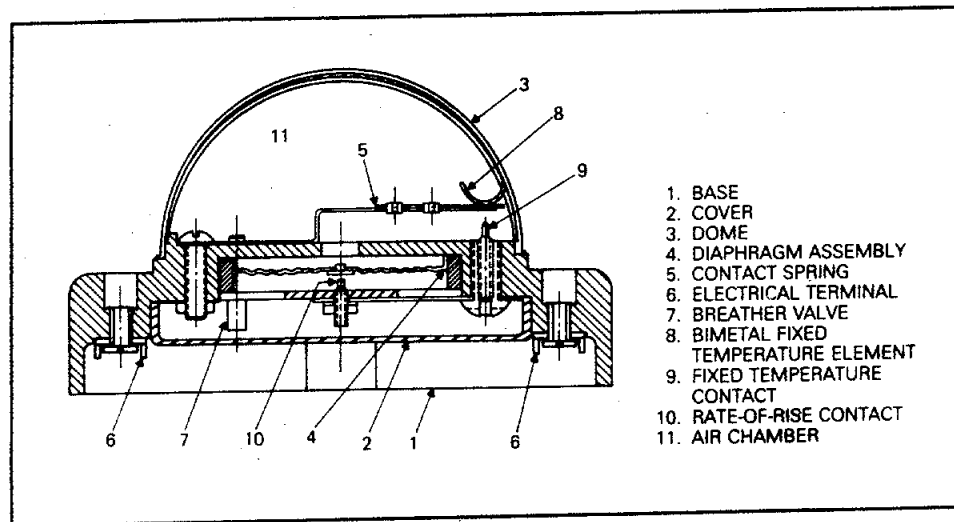

Figure VI-5. Combination heat detector.

Reprinted with permission from *Fire Alarm Signaling Systems, 2nd Ed.*, Copyright © 1994, National Fire Protection Association, Quincy, MA 02269.<sup>1</sup>

Heat detectors are in general reliable devices and are not subject to false alarms. They are commonly used where smoke detectors may be too sensitive. Nonetheless, their response time may be slower than that of aerosol detectors.

Detectors that sense infrared or ultraviolet radiation emitted by fires provide the fastest identification of a fire signature. Furthermore, these devices can be used in buildings with high ceilings where dilution of smoke and heat signatures render the devices discussed in the previous sections less effective.

Infrared flame or ember detectors use optical systems that direct incoming light to an infrared radiation sensor, see Figure VI-6. Filters eliminate solar infrared radiation which otherwise could mask combustion-related infrared emissions. Additionally, flame flicker detectors that operate in the frequency that flames oscillate (5 to 30 Hz) can be used. The frequency characteristics of flames are not usually present in the other sources of infrared energy that may confound these types of flame energy detectors. Typically, infrared energy detectors are used for fixed volume observation or in a scanning mode.

In principle, ultraviolet flame detectors are similar to infrared detectors, however, they use a different detection system specific to ultraviolet energy. Ultraviolet detectors are insensitive to sun and artificial light but, for example, register energies from electric arc welding. Combinations of ultraviolet, infrared and flame flicker detectors are used in sophisticated applications along with logical control (i.e. "and", "or", logical control) to alarm and to set suppression activity in motion.

Since infrared and ultraviolet flame detectors are capable of responding very rapidly, they are often used to activate explosion suppression systems.

### Infrared and ultraviolet flame detectors

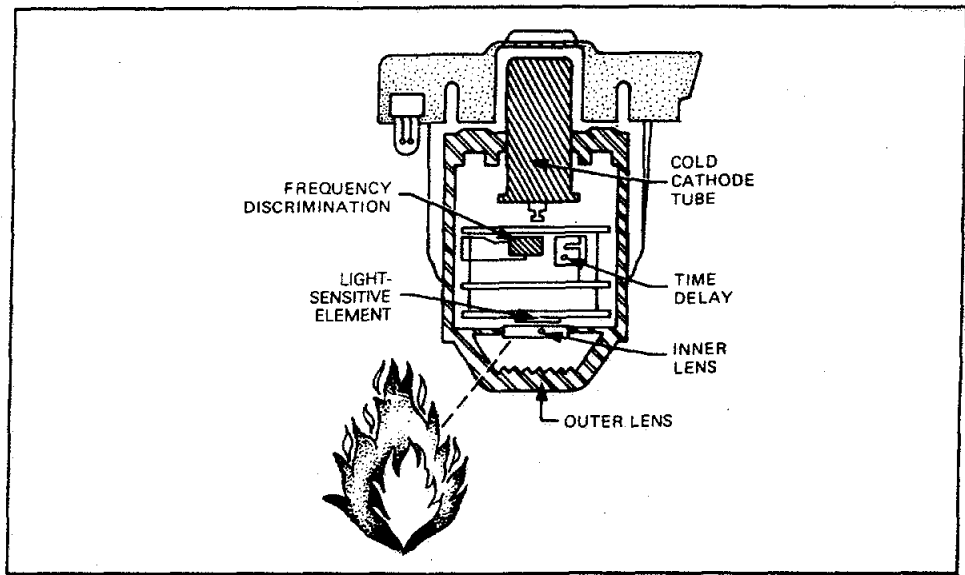

Figure VI-6. Infrared radiation detector. A light sensitive element attached to a frequency discriminating device is used to sense infrared radiation.

Reprinted with permission from *Fire Alarm Signaling Systems, 2nd Ed.*, Copyright © 1994, National Fire Protection Association, Quincy, MA 02269.<sup>1</sup>

### Gas sensing detectors

The equipment developed to sense atmospheric levels of many gaseous contaminants of air has improved dramatically in recent years, in terms of reliability, the range of materials that can be sensed, the size of the equipment, and the costs of buying, installation and using it. Gas sensing detectors are used not only to detect fire signatures on the basis of the levels of materials usually not found in air, but also to monitor occupational environments to protect workers from harmful exposures.

Modern construction and office supply materials include a host of different polymeric materials that, when involved in fire, may produce very hazardous materials. Some of these products of combustion are fuel specific and thus detection devices can be selected based on specific gaseous contaminants with specificity for particular locations. For example, materials such as HCl, HCN, NH<sub>3</sub>, and oxides of nitrogen may result from combustion of some polymers. A wide range of sensing mechanisms can be used for quantitative analysis of specific gases. Several different strategies are used with these devices with regard to monitoring the air for the presence of these materials (at appropriate levels to indicate combustion).

These devices may be appropriately used in property protection from fire in a control room. These gas detection devices are used and tuned to detect low levels of the specific products of combustion because electronic equipment is susceptible to damage as a result of exposure to products of combustion of even small or smoldering fires. In this manner, rapid response with minimal damage is ensured. For this scenario, life safety is served in two ways: first, early detection warns occupants of the control room, and second, critical functions directed from the control room are preserved.

## **FIRE DETECTION SYSTEM CONCERNS**

As described in OSHA 1910.164<sup>2</sup>, some concerns are associated with the selection, installation, maintenance and operation of detection systems. The number, spacing and location of devices must be in accordance with the nature of the devices. Following initiation of a signal by a detection device, the device must be restored promptly. Detection devices must be maintained, tested and adjusted by trained personnel to maintain proper reliability. Devices must be protected and the response time of a device should ensure the objectives of its installation.

### **Fire alarm system details**

This unit has presented a general discussion. Details concerning the design, installation, commissioning, maintenance and testing of fire alarm systems can be found in the references listed below. NFPA 72<sup>3</sup> (National Fire Alarm Code) as well as OSHA 1910.164<sup>2</sup> and OSHA 1910.165<sup>2</sup> set the requirements for detection and alarm systems. In a joint project, NFPA and Society of Fire Protection Engineers have published "Fire Alarm Signaling Systems"<sup>1</sup> as a resource to help users apply the codes and standards and to act as a utilitarian guide for basic operational requirements.

### **REFERENCES**

1. Bukowski R, O'Laughlin R, Zimmerman CE [1994]. Fire alarm signaling systems. 2nd ed. Quincy, MA: National Fire Protection Association, Inc., 430 p.
2. CFR. Code of Federal regulations. Washington, DC: U.S. Government Printing Office, Office of the Federal Register.
3. NFPA [1993]. NFPA 72, National fire alarm code. Quincy, MA: National Fire Protection Association, 269 p.

### **SAMPLE QUIZ QUESTIONS**

1. A warehouse, 20 m x 20 m x 6 m (high), has sprinkler heads below the ceiling on a 4 m square grid. A gasoline fire (diameter 1.2 m) is ignited equidistant from 4 heads. The nearest heads are immersed in fire gas of temperature  $T_g = 109^\circ\text{C}$  and velocity  $u = 2.53 \text{ m s}^{-1}$ . Calculate the time to activation of the heads assuming  $t = -RTI u^{-1/2} \ln \{1 - \Delta T_s / \Delta T_g\}$ ; where  $t$  is time to activation (s);  $RTI$  is the response time index of a head ( $\text{m}^{1/2}\text{s}^{1/2}$ );  $u$  is the velocity of the fire gas ( $\text{m s}^{-1}$ );  $\Delta T_s$  is temperature (above ambient) at which the head activates ( $^\circ\text{C}$ ); and  $\Delta T_g$  is temperature (above ambient) of the fire gas. Assume the ambient temperature is  $20^\circ\text{C}$ ; the  $RTI$  is  $150 \text{ m}^{1/2}\text{s}^{1/2}$  and the activation temperature is  $74^\circ\text{C}$ .
2. Flaming combustion of cellulose (wood, paper, etc.) generates a high concentration of small smoke particles; whereas smoldering fires produce a low concentration of large smoke particles.
  - a) An ionization detector is sensitive to the number of particles in an aerosol as activation depends on collisions between particles and ions. Is an ionization detector more sensitive to a flaming or smoldering fire?
  - b) A photosensitive device is sensitive to the presence of large particles which scatter much light. Is a photosensitive detector more sensitive to a flaming or smoldering fire?

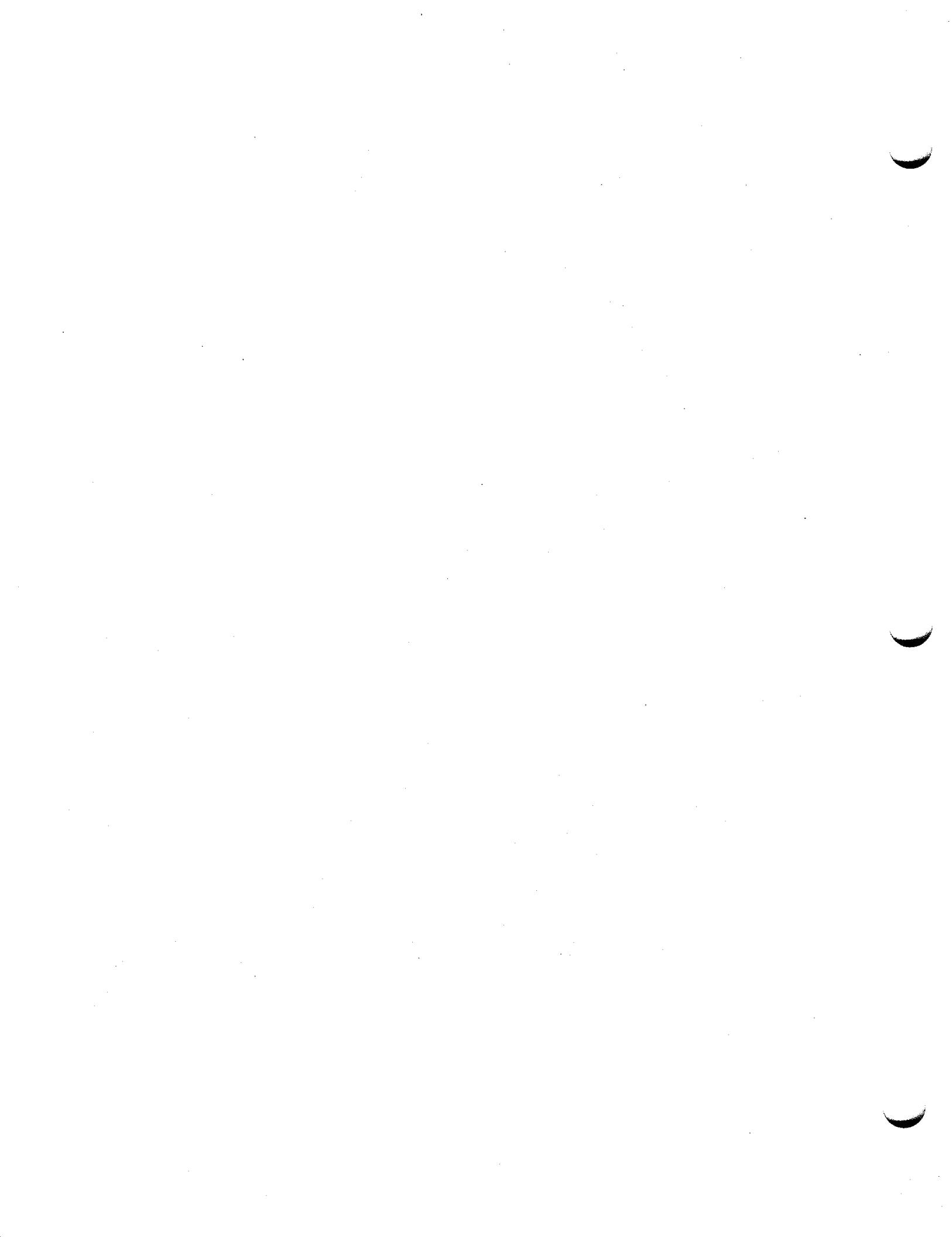

**Unit VII**  
**FIRE SUPPRESSION**

**PURPOSE:** To familiarize the reader with the basics of fire suppression.

**OBJECTIVES:** To present aspects of fire suppression including:  
1. The theory of suppression  
2. Compatibility of the suppression system with the hazard

**SPECIAL TERMS:**

1. Water-based suppression
2. Foam-based suppression
3. Chemical-based suppression
4. Automatic suppression systems
5. Fire services
6. Portable fire extinguishers

## **INTRODUCTION**

This Unit presents the issues related to the suppression of fires. Although the term fire suppression is common and in general is taken to mean checking or stopping a fire, the techniques described in this Unit may not only suppress a fire, but may often extinguish it.

This Unit discusses the three major means of suppressing fires: automatic suppression systems, fire services, and extinguishers. Automatic suppression systems, such as sprinklers, were originally developed and introduced by the insurance industry more than a century ago for the purpose of property protection. The design of such systems has evolved, and they are also now used to achieve life safety objectives.

## **THEORY OF SUPPRESSION**

Unit III introduced the fire tetrahedron and mentioned four mechanisms to suppress a fire: elimination of oxidant, fuel or heat from the fire zone; and interference with the combustion chain reaction. The following discussion demonstrates that these four mechanisms are used often and in combination to suppress fires.

### **Water**

Water is by far the most commonly used fire suppression agent. Although limitations are associated with the use of water for this purpose, water has many strong advantages. In addition to its widespread availability and low cost, water has a number of physical properties that make it a good choice to suppress or extinguish fires.

Water is a stable, relatively dense and inviscid liquid at room temperature and it has favorable thermal properties for the purposes under consideration here. In particular, the latent heat of vaporization of water is approximately 2250 kJ/kg at normal conditions. That is, a large amount of heat is involved in the vaporization of water. If the rate of heat release from a fire is taken up in vaporization of a noncombustible material such as water, then the fire can be controlled. If the rate at which heat is absorbed in the vaporization of water is greater than the fire heat release rate, then the fire is being extinguished.

The objective in suppressing fires with water is to deliver water to the fire in such a state that the fire can be quenched by cooling. With its reasonably high surface tension, water can be delivered as small droplets that improve heat transfer by dramatically increasing the area of contact between the flame and the mass of water used to suppress the fire. To aid in the heat transfer process, water is sprayed onto burning surfaces. In addition to the cooling effect, the conversion of liquid to gas involves a volume increase of about 1,500 times. This rapid expansion in the fire zone serves to exclude air from the fire thereby smothering it. Although this method is often a secondary effect with respect to extinguishing fires, it does inhibit continuation of the combustion.

The use of water for fire suppression has some drawbacks. Most important is that water cannot be left in pipes subject to temperatures at which freezing may occur. This problem has several solutions: (1) use additives in the water, (2) do not allow the water to reside in areas where freezing is a possibility, and (3) circulate heated water in the suppression systems.

Other problems with water relate to: (1) viscosity, (2) surface tension, (3) electrical conductivity, and (4) density. From one point of view, increasing the viscosity of water is beneficial because it adheres more easily and forms a thicker covering on solid materials. However, when viscosity is increased, the pumping requirements for delivery of water also increases. Wetting agents can be added to water to ensure that it can penetrate into the interstices of porous materials that may be involved in combustion.

Impurities normally found in water render it electrically conductive, and therefore a potential problem when used to suppress electrical equipment fires. One solution to this problem is to shut off automatically the power to electric equipment when water is used to suppress fires. Finally, water should not be used to extinguish liquid fires in which the combustible material has a density less than that of water because the lighter liquid will float on the water and continue to burn.

Some situations involve specialized materials for which water is not the suppressant of choice. Examples of these are: combustible metals, materials that react with water and result in hazardous conditions, and gas fires.

## Foams

Foams are created when air (or some other gas) is trapped because of surface tension effects in a liquid. Water is the most commonly used liquid in foam systems. If water containing additives is mixed with air, a foam may result. With regard to fire suppression, the additives could be synthetic materials, detergents, and proteins, among others. Foaming agents are usually added at concentrations of a few percent. Some foam producing additives are specific for particular applications. The advantages of using a foam include: increased water surface area exposed to the combustion material, thicker and more stable coating of suppressant on a solid surface, and prevention of access of oxidizing agent to the combustion surface. Foams extinguish fires because of their cooling effect and their ability to smother the fire. Additionally, foams are of low density and therefore they can float on liquid surfaces and extinguish fires there. Foams also can suppress vapor production by completely covering of a liquid surface.

Foams are classified according to their relative volume compared with an equal mass of water. Low expansion foams occupy up to 20 times the volume of an equal mass of liquid water while high expansion foams can be generated with up to 1,000 times the volume of an equal mass of liquid water.

Foams can be produced by several methods including foam induction, proportioning, and pressure generation. Induction methods involve suction of the foam concentrate into a flowing stream of water, while the proportioning methods use pumps to deliver the foaming agent into the water supply. In pressure foam generation, water and the foaming agent are mixed with air under pressure before delivery to the discharge nozzle.

Foams are usually not used to flood a large area completely. Foam extinguishing systems are designed to be used in association with a specified process or material; that is, foams are usually used in a local application. Hand lines (fire hoses) are often the method of directing foams to the combustion area.

Aqueous-based foams are electrically conductive and therefore care should be taken if they are used to suppress fires involving, or in the vicinity of, electrical equipment. Generally, foams are not recommended for gaseous fires, cryogenic materials, flowing liquids, and with metals or other materials that react strongly with water.

Standards associated with the use of foams are NFPA 11<sup>1</sup>, NFPA 11A<sup>2</sup>, NFPA 16<sup>3</sup> and OSHA 1910.163.<sup>4</sup>

## Carbon dioxide

Carbon dioxide is used to suppress fires because of its ability to displace the oxidizing agent from the combustion zone. When the oxygen content of air is reduced from its normal value of about 21% to below 15%, many fires will not be able to react sufficiently to sustain combustion. CO<sub>2</sub> is usually used in enclosed spaces or for specific



area applications. CO<sub>2</sub> has an advantage over other means of suppression because it is not electrically conductive and does not contaminate the area or products within the area of use. As an extinguishing agent, CO<sub>2</sub> leaves little residue and is easy to clean up. This property may be important in industries in which cleanliness is imperative, such as those related to foodstuffs, pharmaceuticals, and computer processing. Details related to the use of CO<sub>2</sub> extinguishing systems can be found in NFPA 12<sup>5</sup>.

### **Halon**

Halons are a family of halogenated hydrocarbons, in which some or all of the hydrogen atoms are replaced by fluorine, chlorine or bromine. The hydrocarbon most commonly used for this application is methane; however, ethane is sometimes used. These materials suppress fires by interfering with the combustion reaction. Unfortunately, these very effective fire suppression agents have deleterious effects on the environment (destruction of the ozone layer) and they are toxic to humans in high concentrations. The use of halons is being phased out. The fire suppression industry is working to find replacements for halons. Halon fire extinguishing systems are discussed in NFPA 12A.<sup>6</sup>

### **Dry chemicals**

Powders of dry chemicals when sprayed on a fire can suppress combustion. The materials typically used in this application are: sodium, potassium or urea-potassium bicarbonates as well as potassium chloride or mono-ammonium phosphate. Although these materials may smother the fire, exert a cooling effect, or even reduce radiation to the fuel, the primary action of these fire suppression materials is believed to be their ability to interfere with the combustion reaction required to sustain the fire. These materials are notorious for the rapidity with which they can extinguish fires.

Dry chemical can be used to suppress fires in both a total system flooding mode or local application. These materials are basically nontoxic and can be used for electrical fires. Their primary use is associated with fire suppression of flammable liquids. Additives are sometimes used to improve the storage and handling properties of these dry materials. NFPA 17<sup>7</sup> describes the use of dry chemicals in extinguishing systems.

## **AUTOMATIC SUPPRESSION SYSTEMS**

Automatic suppression systems are often used to ensure rapid application of suppression agents in the event of fire. The earlier fire suppression commences the less likely it is that there will be loss of life or serious property damage. Several automatic suppression systems are described in the next sections.

### **Automatic water sprinkler systems**

Automatic water sprinkler systems are cost effective and are the most widely used automatic fire suppression systems. In addition to the numerous standards involved with sprinkler systems (most notably the relevant sections of NFPA 13<sup>8</sup>, and OSHA Standards 1910.159<sup>4</sup>, 1910.160<sup>4</sup>, and 1910.163<sup>4</sup>), several specific references (e.g. Solomon 1994<sup>9</sup>) and general references (e.g. SFPE Handbook 1995<sup>10</sup>; Fire Protection Handbook 1992<sup>11</sup>) serve as resource materials for the design, engineering and testing of these systems.

The basic elements of an automatic water sprinkler system are as follows:

1. a detection system that is either part of the sprinklers or an entirely separate system,
2. a control unit that responds to the detection system,
3. a water supply that meets the requirements of the suppression system; these include adequate volume and pressure as well as reliability,
4. hydraulically designed piping system that is compatible with the water supply and that can deliver a specified amount of water when sprinklers are activated,
5. sprinkler heads with rated discharges positioned in appropriate areas and numbers to suppress fire. If the sprinklers heads are open, a separate detection system

must be used to actuate water flow. If the sprinkler heads have closed orifices, which is more common, the heads open automatically when fire is detected by the heads (i.e., the links open).

6. an automatic alarm system that can warn people in the area that the sprinkler system is activated and water flow has begun to suppress the fire.

In addition to these considerations, automatic sprinkler system design includes false alarm protection devices, shut-off valves (usually at the point of entry into the building), external alarming, water removal capabilities, the potential for auxiliary action (e.g. door closure, shut-off of specified electrical services including process equipment and exhaust fans) and a manual means of initiating the system.

Wet pipe water sprinkler systems use automatic sprinklers (discussed briefly in Unit VI) attached to a piping system full of water that is connected to the water supply. When the sprinklers detect heat from the fire and open, water is discharged in the area of detection.

Dry pipe systems operate in a similar fashion except that the piping system contains pressurized gas (air or nitrogen). When a sprinkler detects a fire, it opens and this pressurized gas is released which actuates a valve allowing water to flow into the piping system and through the sprinklers. This type of system has an obvious advantage over the wet pipe system when the possibility exists of water freezing in the piping system.

Preaction systems can contain air (not necessarily under pressure) in the piping system but also have additional detection devices in the areas covered by the sprinklers. When these detection devices are activated, water is permitted to flow into the piping system and through any sprinklers that are open.

A deluge system has open sprinklers and a detection system that controls the water supply. When activated, water is permitted to flow and be discharged through the open sprinklers.

Sprinklers come in a variety of types including, as mentioned earlier, those with and without detection capabilities. Sprinklers can be mounted in rooms either from the ceiling (upright sprinklers are intended for use in the upright position, while pendent sprinklers are installed under water supply pipes) or walls (sidewall sprinklers). They can be concealed or exposed. Considerable engineering efforts have gone into development of sprinklers so that patterns of discharge of water as well as the amount of water delivered are sufficient for suppression. For further details concerning the types of calculations required to meet suppression needs, the reader is directed to the references cited in this unit.

Dry pipe sprinkler systems considerations are similar to those described earlier. Although these systems can be used in areas where freezing may be a problem, they have an additional time delay associated with the delivery of water compared with wet pipe systems. The manner in which the control valves operate also requires considerations different from those needed for wet pipe systems. Regardless of which type of system is used, periodic testing is required to ensure that the water supply and the remainder of the automatic sprinkler system can operate as intended.

### **Foam extinguishing systems**

Most of the same general considerations as described earlier apply to automatic foam extinguishing systems that generate foam at the time of use. Because of the nature of foams and how they are formed from water and the foaming agent, care must be taken

to ensure that the mechanisms associated with generating the foam are not compromised during a fire. Additionally, nozzles that are specific to foams are required for proper delivery of the foam to the fire. In some applications, foams are used to cover completely a liquid surface that is engulfed in flames. Under these circumstances the foam is sometimes applied from the edges of the liquid container from where the foam spreads across the entire liquid surface. Specific details about standards for foam extinguishing systems can be found in various sections of NFPA 11<sup>1</sup> and 16<sup>3</sup> as well as in OSHA 1910.163.<sup>4</sup>

**Carbon dioxide systems**

Carbon dioxide extinguishing systems can be used to flood an area totally, but they are usually used for relatively small enclosed areas or for a local application, particularly for gas fires. NFPA 12<sup>5</sup> and OSHA 1910.162<sup>4</sup> contain the standards relevant to the use of CO<sub>2</sub> extinguishing systems. In the event of a gas fire, the supply of gas should be shut off automatically once the fire is detected and the CO<sub>2</sub> extinguishing system is activated. With regard to fire in an enclosure in which humans are not present, room openings such as vents, windows and doors should be closed automatically so that the CO<sub>2</sub> can be effective in reducing the oxygen content near the fire. In addition to the extinguishing system components, storage of the CO<sub>2</sub> must be considered. Piping design, discharge nozzles and valves, and other operating devices are specific to the use of this agent, which is usually stored as a liquid under pressure. This latter condition creates the potential for safety hazards.

**Halon extinguishing systems**

Many of the same considerations for the use of CO<sub>2</sub> also apply for halon. This material, which is usually a gas at normal conditions, is also stored under pressure as a liquid when used as an extinguishing agent. Standards covering halon extinguishing systems can be found in the subsections of NFPA 12<sup>5</sup> or OSHA 1910.162.<sup>4</sup> A high level of noise as well as fogging or clouding is usually associated with discharge of halons. In addition, special piping system design is required. However, the use of halons is being phased out and materials with similar properties as halons are being researched.

**Dry chemical systems**

Dry chemical extinguishing systems deliver solid materials to suppress the fire. The solid materials are usually in the form of a powder that can be propelled to the fire by pressurized gas. The solids and gas (usually nitrogen) can be premixed or mixed from separate containers as they are expelled onto the fire. Additives are often used to ensure that no clumping occurs and that the solid entrainment and delivery via a pressurized gas proceeds smoothly. Specialized piping designs, nozzles and control systems are required for the two-phase flow form of fire suppression. The relevant standards are NFPA 17<sup>7</sup> and OSHA 1910.161<sup>4</sup>.

**SUPPRESSION BY THE FIRE SERVICES**

Fire services can include both in-house fire brigades and public fire departments. No simple formula exists for both the determination of the need for in-house services and for the specific interaction and distribution of responsibilities between local facility services and the public services. A need exists for a local emergency plan that may involve various levels of government.

**In-house fire brigades**

If a facility-specific fire brigade is required, then a number of issues related to its effective operation must be addressed. Individuals must be selected and trained for duties in the fire brigade. Their education should be both wide ranging with regard to fire suppression and specific concerning the probable nature of fire suppression at that facility. The members of the brigade must be physically fit and trained in the proper use of fire fighting equipment. Additionally, they must have proper personal protective equipment including proper respirators for the situations that they may encounter.

Services must be secured that relate to fire protection, such as the availability of water supplies and access to all sites. An emergency action plan and pre-fire planning is required. These may involve risk management studies and must include information describing building occupancy, construction and contents. The fire protection features of the building or areas must be known including the location and availability of water supplies. Unusual environmental features that may affect fire fighting must be considered. The fire brigade must know the facility so that critical concerns relating to the spread of the fire can be identified. Pre-fire fighting plans must involve other fire fighting agencies, who may be called on to cooperate. To assist in suppression activities, information relating to materials and equipment on site must be pre-recorded in special forms to avoid delays in decisions concerning fire fighting procedures.

### **Public fire departments**

The size and capabilities of public fire departments vary significantly depending on location (city versus rural) and population. As described earlier, an in-house fire brigade must devise plans with local fire authorities to ensure effective fire suppression. In the absence of a facility-run brigade, open communications should be maintained with local fire departments who would be summoned via the fire alarm system at the industrial site. Pre-fire planning would ensure compatibility between public equipment and site services (e.g. water main connections), and inform the public fire fighting agency of the materials and equipment that are likely to be involved in a fire. In this spirit of cooperation, public fire department personnel would be notified beforehand of procedures that must be used in fighting specific fires. Additionally, they would be aware of hazardous conditions associated with those fires. These issues may be critical if the public fire fighters are not pre-trained in specific industrial fire fighting techniques. Also, the response times and the expected levels of support from the public agencies can be anticipated; both of these concerns can have a significant influence on how suppression of a fire is managed.

### **PORTABLE FIRE EXTINGUISHERS**

Portable fire extinguishers are mandatory in all buildings, except residences, and are intended for use in the early stage of fire development. Persons using these devices should be trained. A critical feature of these devices is that they have a limited capacity.

Suppression agents discussed in automatic sprinkler systems are also used in portable fire extinguishers. Fire extinguishers must be suitable for the class of fire that they are used to suppress. Fires are characterized into the following classes based on the burning material, see also Figure VII-1:

- Class A: common solid materials including wood, paper, some plastics and textiles.
- Class B: liquids or solids that produce combustible liquids when involved in fire.
- Class C: Class A or Class B materials with the involvement of electrical equipment.
- Class D: combustible metals.

Considerations for selection, placement, and use of portable fire extinguishers include:

1. symbols (and color coding) fixed to extinguishers designating the type (or types) of fires that the extinguisher can be used on,
2. a designation of the rating of the extinguisher (i.e. a reference to the volume or applicable area for the extinguishing material; these designations are not available for all extinguishers),
3. distribution of extinguishers based on the hazard classification of the area to be protected (more than one type of extinguisher may be appropriate),
4. maximum travel distance of the extinguishing material for Class B fires, fires, extinguishers
5. inspection, maintenance, and testing of fire extinguishers, and
6. training and education programs.

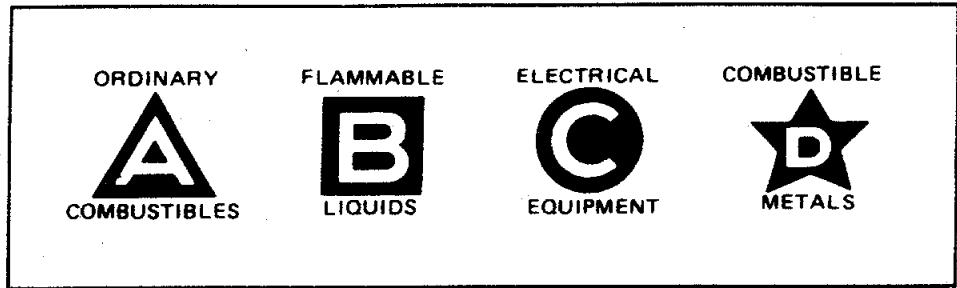

Figure VII-1 Fire extinguisher classification labels. Geometric and lettered labels are shown. When color coded, Class A fire extinguishers have green labels, Class B - red labels, Class C - blue labels and Class D - yellow labels.

Reprinted with permission from NFPA 10, *Portable Fire Extinguishers*, Copyright © 1994, National Fire Protection Association, Quincy, MA 02269. This reprinted material is not the complete and official position of the National Fire Protection Association, on the referenced subject which is represented only by the standard in its entirety.

Standards for portable fire extinguishers are found in NFPA 10<sup>12</sup> and OSHA 1910.157<sup>4</sup>.

**Water based extinguishers**

Water-based extinguishers intended for use on Class A fires are the most common type. A schematic of a pressurized water extinguisher is shown in Figure VII-2. In addition to water, other materials such as antifreeze may be added. A pressure gauge can be viewed to ensure that the unit is operational. In general the 2 to 2.5 gal units weighing approximately 30 lb are charged to approximately 100 psi and are capable of discharging water to a distance of about 30 ft for a period of 1 min. These fire extinguishers can be recharged. To use this unit, a ring pin placed through the handle must be removed. The nozzle is then directed toward the fire and the levers are squeezed.

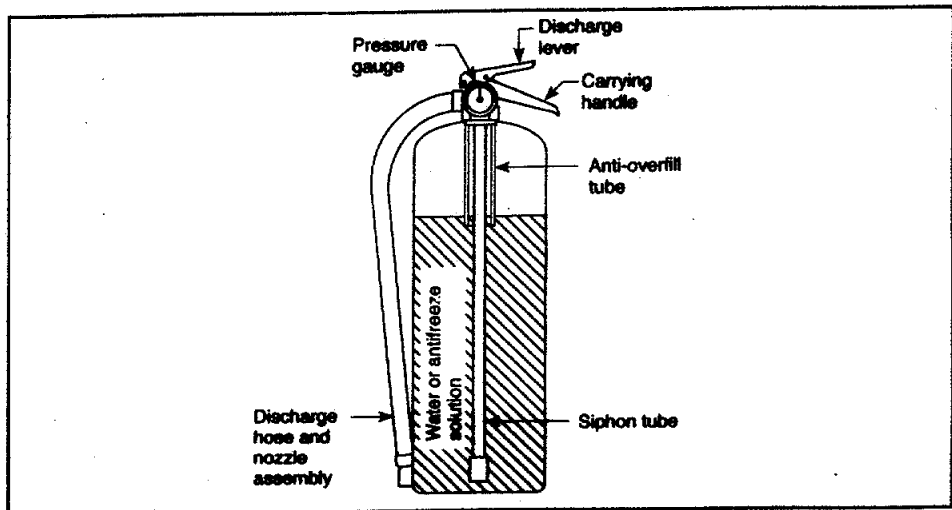

Figure VII-2 A pressurized water fire extinguisher.

Reprinted with permission from NFPA 10, *Portable Fire Extinguishers*, Copyright © 1994, National Fire Protection Association, Quincy, MA 02269. This reprinted material is not the complete and official position of the National Fire Protection Association, on the referenced subject which is represented only by the standard in its entirety.

**Foam extinguishers**

Foam extinguishers can be used on Class A and B fires. Aqueous film forming foam (AFFF) extinguishers are the most common examples. These devices are similar to water-based extinguishers except that the solution of water and foaming agent is passed through an aspirating nozzle to induce foaming. Because the foam is water-based, this type of extinguisher should not be used for fires involving electrical equipment.

**Carbon dioxide extinguishers**

CO<sub>2</sub> can be used on Class A, B and C fires. A CO<sub>2</sub> extinguisher is shown in Figure VII-3. The discharge hose is much larger than that for water-based suppression agents because the rapid expansion of liquid CO<sub>2</sub> produces a cloud of expanded gas that undergoes significant cooling. Directing this material over significant distances is difficult, so the discharged gas should be applied reasonably close to the base of the fire.

**Dry chemical extinguishers**

Dry chemical extinguishers contain powder and a cylinder of compressed gas (usually nitrogen). When the extinguisher is activated, the gas discharges from the nozzle and carries with it a stream of powder for up to 20 ft. These extinguishers are usually designed for Class B or C fires, but some can also be used for Class A fires. This type of extinguisher leaves a powder residue that can be reactive following fire. Therefore, the use of these extinguishers is limited where contamination may be a problem.

**Class D extinguishers**

The suppression agent used for metal fires is dictated by the metal that is involved in fire. These extinguishers are similar to dry chemical extinguishers, yet are different in some ways. Most notably the low pressure in these extinguishers projects the powdered material without blowing the burning metal about. These extinguishers are generally not suitable for extinguishing other classes of fires.

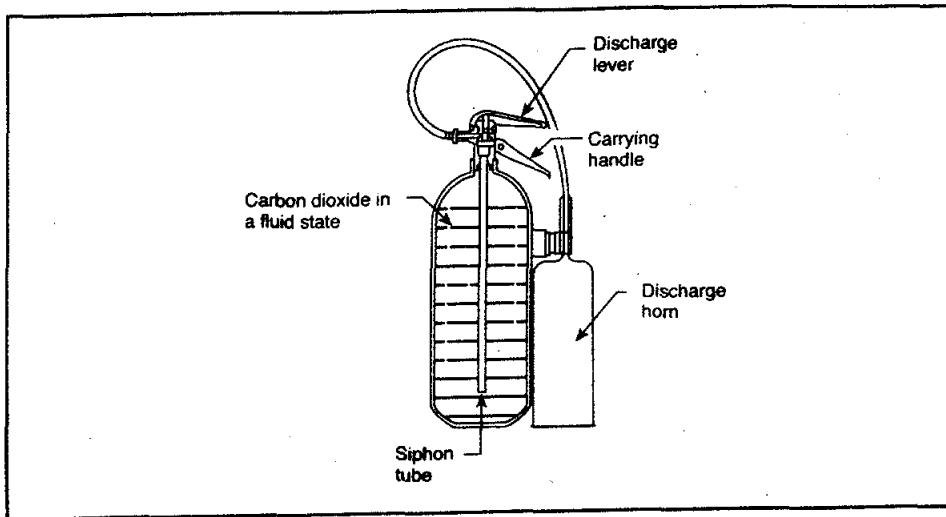

Figure VII-3 A typical CO<sub>2</sub> fire extinguisher.

Reprinted with permission from NFPA 10, *Portable Fire Extinguishers*, Copyright © 1994, National Fire Protection Association, Quincy, MA 02269. This reprinted material is not the complete and official position of the National Fire Protection Association, on the referenced subject which is represented only by the standard in its entirety.

## REFERENCES

1. NFPA [1994]. NFPA 11, Standards for low expansion foam and combined agent systems. Quincy, MA: National Fire Protection Association, 51 p.
2. NFPA [1994]. NFPA 11A, Standards for medium and high expansion foam systems. Quincy, MA: National Fire Protection Association, 23 p.
3. NFPA [1995]. NFPA 16, Standard on deluge foam-water sprinkler and foam-water spray systems. Quincy, MA: National Fire Protection Association, 20 p.
4. Code of Federal Regulations (CFR) Title 29, Part 1910 [1997]. Washington, DC: U.S. Government Printing Office, Office of the Federal Register.
5. NFPA [1993]. NFPA 12, Standards for carbon dioxide extinguishing systems. Quincy, MA: National Fire Protection Association, 46 p.
6. NFPA [1992]. NFPA 12A, Standards for halon 1301 fire extinguishing agent systems. Quincy, MA: National Fire Protection Association, 64 p.
7. NFPA [1994]. NFPA 17, Standard for dry chemical extinguishing systems. Quincy, MA: National Fire Protection Association, 22 p.
8. NFPA [1994]. NFPA 13, Standards for the installation of sprinkler systems. Quincy, MA: National Fire Protection Association, 124 p.
9. Solomon R, ed. [1994]. Automatic sprinkler systems handbook. 6th ed. Quincy, MA: National Fire Protection Association, 790 p.
10. Fleming RP [1995]. Automatic sprinkler calculations. In: SFPE handbook of fire protection engineering. 2nd ed. Ed by DiNenno PJ, Beyler CL, Custer RLP, Walton WD, Watts JM Jr, Drysdale D and Hall JR Jr. Quincy, MA: National Fire Protection Association, p. 4-56, Chapter 4-3.
11. Cote A, Linville J, eds. [1992]. Fire protection handbook. 17th ed. Quincy, MA: National Fire Protection Association.
12. NFPA [1994]. NFPA 10, Standards for portable fire extinguishers. Quincy, MA: National Fire Protection Association, 50 p.

## SAMPLE QUIZ QUESTIONS

1. a) A post-flashover fire is burning in a room. The window (width  $w=2.0$  m: height  $h=1.5$  m) is broken but the door to the inside of the building is closed and intact. The fire is ventilation-controlled and the rate at which heat is released by the fire can be approximated as  $Q = 1100 w h^{3/2}$  {where  $Q$  is in kW, and  $w$  and  $h$  are in m}. Calculate the rate at which heat is released in the fire.  
b) Suppose that water mist is applied to the fire. At what rate ( $\ell/\text{min}$ ) must the mist be applied to absorb the heat being released by the fire? Assume perfect efficiency; that is, the rate of heat release = rate of heat absorption by water with no excess water mist applied. Assume the mist starts as liquid droplets at  $20^\circ\text{C}$ . Account for the energy required to heat the droplets to  $100^\circ\text{C}$  and then vaporize them to steam at  $100^\circ\text{C}$ . Assume the density of water is  $1000 \text{ kg}/\text{m}^3$ , the specific heat of water in the range  $20$ - $100^\circ\text{C}$  is  $4.182 \times 10^3 \text{ J}/(\text{kg } ^\circ\text{C})$  and the heat of vaporization of water is  $2.26 \times 10^6 \text{ J}/\text{kg}$ .
2. Suppose 1 kg of water is sprayed on a fire and is vaporized to form water vapor at temperature  $100^\circ\text{C}$ . Use the ideal gas law to compute the resultant increase in volume of the vapor compared to the original water.

## GLOSSARY

- AEROSOL:** the liquid and solid particulates in smoke.
- AEROSOL DETECTOR:** a detector designed to be activated by the liquid and solid particulates in smoke.
- AUTO-IGNITION TEMPERATURE:** the lowest temperature at which a vapor/air mixture within its flammability limits can undergo spontaneous ignition.
- AUTOMATIC SUPPRESSION SYSTEM:** a fire suppression system that activates upon detection of a fire without the need for human intervention.
- BUILDING CODE:** a set of requirements intended to ensure that an acceptable level of safety (including fire safety) is incorporated into a building at the time of construction.
- BUILDING SERVICES:** provisions, such as heating, plumbing, electrical and air handling systems, that render a building habitable.
- CHEMICAL ASPHYXIANTS:** toxicants that depress the central nervous system causing loss of unconsciousness and ultimately death.
- CLASS A FIRE:** fire involving common solids such as wood, paper, and some plastics and textiles.
- CLASS B FIRE:** fire involving liquids or solids (such as thermoplastics) that produce combustible liquids when they burn.
- CLASS C FIRE:** fire involving Class A or Class B materials as well as electrical equipment.
- CLASS D FIRE:** fire involving combustible metals.
- CODE:** comprehensive set of requirements intended to address fire safety in a facility. Codes may reference numerous standards.
- COMBUSTIBLE LIQUID:** a liquid with flash point equal to or greater than 100°F (38°C).
- COMPARTMENTATION:** a fire protection strategy whereby a building is subdivided into compartments that are separated from one another by fire resistant barriers.
- CONDUCTIVE HEAT TRANSFER:** the transfer of heat within solid materials or between solid materials in contact.
- CONVECTED HEAT:** the portion of heat released in a fire that is carried away by the hot products of combustion.
- CONVECTIVE HEAT TRANSFER:** the transfer of heat between a gas and a solid surface at different temperatures.
- DEFLAGRATION:** the rapid propagation of a flame through a vapor/air mixture following ignition.
- DIFFUSION FLAME:** a flame for which combustible vapor and oxidant come from spatially separated sources and must mix before combustion can occur.
- EMISSIVE POWER:** the rate at which radiant energy is emitted by unit surface area of an object.
- EXTINGUISH:** completely put out a fire.
- FIRE:** a process entailing rapid oxidative, exothermic reactions in which part of the released energy sustains the process.
- FIRE ALARM SYSTEM:** fire protection equipment that can detect a fire, warn occupants, alert the fire department and initiate other fire protection activities such as automatic suppression, smoke control, etc.



**FIRE DYNAMICS:** the interaction among the complex phenomena involved in a building fire.

**FIRE FIGHTING FOAM:** a fire fighting medium that is created by adding a foaming agent to a liquid (usually water).

**FIRE PERFORMANCE:** the response of a material or product to a source of heat or flame under controlled fire conditions. Fire performance includes: ease of ignition, flame spread, smoke generation, fire resistance and toxicity of smoke.

**FIRE POINT:** the lowest temperature at which flaming can be sustained at the liquid's surface.

**FIRE PREVENTION CODE:** a set of requirements intended to ensure that, following construction, buildings are equipped, operated and maintained to provide an acceptable level of protection from potential hazards created by fires or explosions.

**FIRE RESISTANCE:** ability of a building assembly to withstand the passage of flame and the transmission of excessive heat, and to stay in place when exposed to fire.

**FIRE SAFETY CONCEPTS TREE:** a decision tree that depicts how various fire safety strategies can work together to achieve fire safety objectives.

**FIRE SIGNATURE:** a property of fire (temperature, smoke concentration, etc.) that is used to detect the presence of fire.

**FIRE SUPPRESSION:** action taken with the intent to control the growth of a fire.

**FIRE TETRAHEDRON:** a schematic representation of fire in which the four elements required to initiate and maintain fire (fuel, oxidant, heat and chain reactions) are depicted as the four corners of a tetrahedron.

**FLAME DETECTOR:** a detector that is activated by electromagnetic radiation emitted by flames.

**FLAME-SPREAD RATING:** a measure of the flame-spreading propensity of a material.

**FLAMMABLE LIQUID:** a liquid whose flash point is less than 100°F (38°C).

**FLASHOVER:** the very sudden transition from the burning of a few objects in a room to full involvement of all combustibles in the room.

**FLASH POINT:** the lowest temperature at which flames will flash across a liquid's surface. The measurement of a flash point is usually done in a loosely sealed vessel referred to as a closed cup.

**GAS SENSING DETECTOR:** a detector that activates when a critical concentration of some gaseous product of combustion is reached.

**HALON:** a hydrocarbon in which some or all of the hydrogen atoms are replaced by fluorine, chlorine or bromine atoms.

**HEAT DETECTOR:** a detector that activates when its sensing element reaches a critical temperature or rate-of-rise of temperature.

**HEAT OF COMBUSTION:** the heat released when a combustible material undergoes complete combustion.

**HEAT TRANSFER:** the flow of heat from regions of high temperatures to regions of low temperature.

**IRRITANTS:** toxicants that irritate the eyes, upper respiratory tract and/or lungs.

**LOWER FLAMMABILITY LIMIT:** the lowest concentration of a vapor/air mixture which can be ignited by a pilot.

**PERFORMANCE-BASED REQUIREMENTS:** codes and standards that require design solutions be engineered to address the expected hazard in such a fashion that an acceptable level of safety (performance) is ensured.

**PILOTED IGNITION:** ignition of a vapor/air mixture by a small ignition source.

**PLUME:** the column of smoke which, due to buoyancy, rises above a fire.

**PREMIXED FLAME:** a flame for which combustible vapor and oxidant are well mixed before combustion occurs.

**PRESCRIPTIVE REQUIREMENTS:** detailed and often rigid measures mandated in codes and standards as the means to ensure fire safety.

**RADIATIVE HEAT TRANSFER:** the emission (by hot objects) of thermal radiation in the form of electromagnetic waves which propagate across open spaces.

**SMOKE:** the airborne particulates (solid and liquid) and gases produced when a material undergoes pyrolysis or combustion.

**STANDARD:** document that addresses a specific fire safety issue. There are standard practices for installing and inspecting fire protection equipment; and standard methods for testing personal protective equipment, building products and fire protection equipment.

**THERMAL DECOMPOSITION (PYROLYSIS):** a process whereby chemical bonds within macromolecules forming a solid are broken by heat and flammable vapors are released.

**THERMOPLASTIC:** a polymeric solid which melts at a temperature lower than its ignition temperature.

**THERMOSET:** a polymeric solid which does not melt but decomposes to generate vapors and char.

**UPPER FLAMMABILITY LIMIT:** the highest concentration of a vapor/air mixture which can be ignited by a pilot.



The NIOSH logo is rendered in a bold, italicized, sans-serif font. The letters are white with a thick black outline, giving it a three-dimensional appearance. The 'N' is particularly stylized with a sharp, angular top.

Delivering on the Nation's promise:  
Safety and Health at work for all people  
through research and prevention

