



PDHonline Course M326 (2 PDH)

Air Moving Systems and Fire Protection

Instructor: A. Bhatia, B.E.

2020

PDH Online | PDH Center

5272 Meadow Estates Drive
Fairfax, VA 22030-6658
Phone: 703-988-0088
www.PDHonline.com

An Approved Continuing Education Provider

Air Moving Systems and Fire Protection

John H. Klote

U.S. DEPARTMENT OF COMMERCE
Technology Administration
National Institute of Standards
and Technology
Building and Fire Research Laboratory
Gaithersburg, MD 20899

July 1993



U.S. DEPARTMENT OF COMMERCE
Ronald H. Brown, Secretary

**NATIONAL INSTITUTE OF STANDARDS
AND TECHNOLOGY**
Arati Prabhakar, Director

Table of Contents

	Page
List of Figures	iv
List of Tables	iv
Abstract	1
1. INTRODUCTION	1
2. CONSTRUCTION MATERIALS	1
3. DAMPERS	2
3.1 Fire Dampers	2
3.2 Smoke Dampers	2
4. SMOKE PROTECTION	3
5. COMPARTMENTATION	4
6. DILUTION	4
6.1 Dilution Away From the Fire	5
6.2 Caution About Dilution Near a Fire	5
7. PRESSURIZATION	6
7.1 Zoned Smoke Control	6
7.2 Pressurized Stairwells	7
7.3 Activation of Pressurization Systems	8
8. AIRFLOW	9
9. BUOYANCY	10
10. CONCLUDING REMARK	11
11. REFERENCES	11

List of Figures

Figure 1.	Multi-Blade Construction Used For Balancing, Control, Fire, and Smoke Dampers [adapted from SMACNA (1981)].	2
Figure 2.	Curtain Fire Damper [adapted from SMACNA (1986)].	3
Figure 3.	Pressure Difference Across a Barrier of a Smoke Control System Preventing Smoke Infiltration to the High Pressure Side of the Barrier.	6
Figure 4.	Schematic of Zoned Smoke Control System Using an HVAC System that Serves Many Smoke Control Zones.	7
Figure 5.	HVAC System With Recirculation Capability in the Smoke Control Mode.	8
Figure 6.	Stairwell Pressurization by Multiple Injection With the Fan Located at Ground Level.	8
Figure 7.	Critical Velocity to Prevent Smoke Backflow in a Corridor.	9
Figure 8.	Atrium Smoke Exhaust System.	11

List of Tables

Table 1.	Leakage classification for smoke dampers	3
Table 2.	Comparison of critical velocity maximum fire size if all the O ₂ in the airflow is consumed	12

Air Moving Systems and Fire Protection

Abstract

The fire hazards associated with heating, ventilating and air conditioning (HVAC) systems are significant. Protection is needed from the spread of fire and smoke due both to fires starting inside an HVAC system and fires starting outside an HVAC system. Fire performance of materials for HVAC components are required, and fire dampers and smoke dampers are needed. To provide smoke protection, an HVAC system can be shut down or it can be put into a special smoke control mode of operation. Smoke from building fires can be managed by the mechanisms of compartmentation, dilution, air flow, pressurization, and buoyancy.

1. INTRODUCTION

A 1939 report by the National Board of Fire Underwriters (NBFU 1939) indicated the significance of fire hazards associated with heating, ventilating and air conditioning (HVAC) systems. The NBFU examined the National Fire Protection Association (NFPA) fire data from January 1936 to April 1938. Of 25 fires recorded, 19 involved combustion of parts of the air moving system. Ducts, duct linings, and filters burned. In five cases of no fire in the HVAC system, smoke was distributed by the system. The NBFU report has had a major impact on the materials and construction of HVAC systems.

While many of the details of fire codes differ with specific applications, there are basic underlying principles behind fire safety of HVAC systems for large buildings. This paper discusses these underlying principles and some generally required approaches to fire safety of HVAC systems. This report also discusses the use of HVAC systems and dedicated fans to control smoke flow during building fires. However, this paper is not an exhaustive treatment of smoke control and HVAC safety requirements. For examples of such an exhaustive treatment the reader is referred to NFPA 90A (1993), NFPA 92A (1988) and NFPA 92B (1991). For exhaustive treatment of the design considerations and engineering principles of smoke management, the reader is referred to Klote and Milke (1992).

Protection is needed from the spread of fire and smoke due to both fires starting inside an HVAC system and fires starting outside an HVAC system. Building designers working with code officials should give special attention to HVAC construction materials and use of fire and smoke dampers.

2. CONSTRUCTION MATERIALS

Ducts and other HVAC components can be made of materials that will not ignite, burn, support combustion, or release flammable vapors when subjected to fire or heat. While steel is the most common noncombustible duct material, others include aluminum, brick, clay tile, concrete, copper, iron, and masonry blocks. Further, many components including air filters, adhesives and flexible duct are allowed to be combustible to a limited extent. Often owners, manufacturers, designers and others desire these limited combustible materials in HVAC

systems for reasons of performance and cost. Limited combustible materials are allowed to the extent that their use has no significant impact on overall life safety. Traditionally, the extent of combustibility that is acceptable has been determined by the professional judgement of code officials and members of standards committees. However, formal methods of hazard analysis (Bukowski et al. 1989) are beginning to play an important role in such determinations.

3. DAMPERS

In air moving systems, dampers are used to: (1) balance airflow, (2) control airflow, (3) resist the passage of fire, or (4) resist the passage of smoke. Balancing dampers are used in ducts to adjust the airflow to the design values. These dampers can be of simple construction or of multi-blade construction (figure 1). Multi-blade dampers operated by electric motors or pneumatic pistons to vary the flow rate are called control dampers. Dampers used to resist the passage of fire are called fire dampers, and these can be multi-blade dampers (figure 1) or curtain dampers (figure 2). Dampers used to resist the passage of smoke are called smoke dampers, and these can also be either multi-blade or curtain. Combination dampers can be used to balance airflow, control airflow, resist the passage of fire, and resist the passage of smoke.

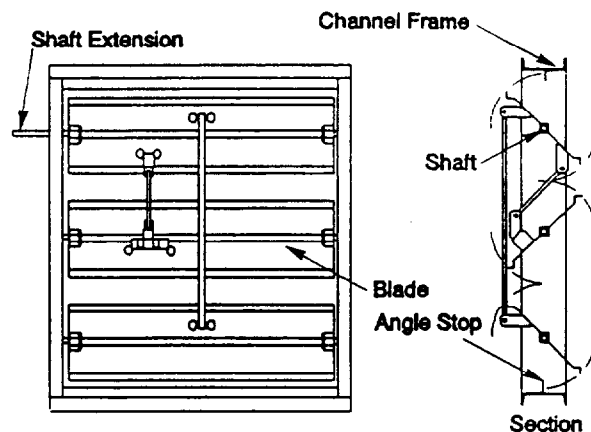

Figure 1. Multi-Blade Construction Used For Balancing, Control, Fire, and Smoke Dampers [adapted from SMACNA (1981)].

3.1 Fire Dampers

Fire dampers are designed to close automatically upon detection of heat, to restrict the passage of heat or flame. Generally, fire dampers are installed in duct penetrations through walls that have been designed to meet a specific level of fire resistance. In the United States, fire dampers are usually constructed and labeled in accordance with standard UL 555 (1990). Generally, multi-blade fire dampers are held open by a fusible link and are spring loaded. In a fire situation, hot gases cause the link to come apart allowing a spring to slam the blades shut. In place of fusible links, some manufacturers use other heat responsive devices. Curtain fire dampers are held open by a fusible link, and they close by gravity or a spring when the link comes apart.

3.2 Smoke Dampers

In HVAC systems without smoke control, smoke dampers close upon detection of smoke to restrict the passage of smoke. Some applications of smoke dampers in smoke control systems are discussed later. In the United States, smoke dampers are usually constructed and classified for leakage in accordance with standard UL 555S (1983). As a convenience to the reader, a general description of the standard follows. UL 555S contains requirements for leakage rated dampers intended for use in heating, ventilating, and air conditioning systems. It includes construction requirements and tests for cycling, temperature degradation, dust loading exposure, salt-spray exposure, air leakage, and operation under airflow. These dampers are classified as 0, I, II, III, or IV leakage rated at ambient or elevated temperatures of 121 °C (250 °F) or at higher in increments of 56 °C (100 °F) above 121 °C (250 °F). They can also be tested at 177 °C (350 °F), 232 °C (450 °F), 287 °C

Table 1. Leakage classification for smoke dampers [adapted from UL 555S (1983)]

Classification	At 0.249 kPa (1.0 in H ₂ O)		At 0.995 kPa (4.0 in H ₂ O)	
	L/(s m ²)	cfm/ft ²	L/(s m ²)	cfm/ft ²
O	0	0	0	0
I	20	4	41	8
II	51	10	102	20
III	203	40	406	80
IV	305	60	610	120

Extended Static Range	At 1.99 kPa (8.0 in H ₂ O)		At 2.99 kPa (12 in H ₂ O)	
	L/(s m ²)	cfm/ft ²	L/(s m ²)	cfm/ft ²
O	0	0	0	0
I	56	11	71	14
II	142	28	178	35
III	569	112	711	140
IV	853	168	1067	210

(550°F), etc. The maximum leakage rates for the different classifications are listed in table 1. Class 0 dampers with zero leakage under this standard are commonly used in nuclear power plants. Generally, classes I, II, III and IV are considered appropriate for smoke control in other types of buildings.

4. SMOKE PROTECTION

The following sections are a general overview of smoke protection, and designers are referred to Klotz and Milke (1992) for design calculations and detailed system capabilities. HVAC systems frequently transport smoke during building fires. When a fire starts in an unoccupied portion of a building, the HVAC system can transport smoke to a space where people can smell the smoke and be alerted to the fire. The NBFU report recommended that HVAC systems be shut down during fire situations to prevent them from spreading smoke and supplying combustion air to the fire. For many years, this system shut-down was the standard

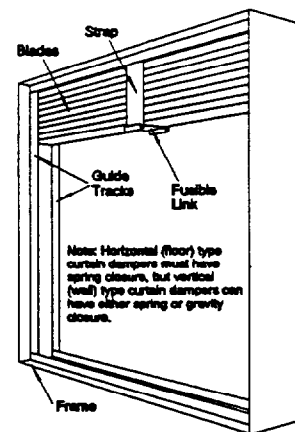

Figure 2. Curtain Fire Damper [adapted from SMACNA (1986)].

approach to achieve smoke protection. However, operation of the HVAC system in a special smoke control mode has become a common alternative in recent years.

The advantages and disadvantages of these approaches are complex, and no simple consensus has been reached regarding a preferred method for various building types. However, if neither fan shut-down nor smoke control is achieved, the HVAC system will transport smoke to every area the system serves. As the fire progresses, smoke in these spaces will endanger life, damage property and inhibit fire fighting. Although shutting down the HVAC system prevents it from supplying oxygen to the fire, system shut-down does not prevent smoke movement through HVAC ducts, stair shafts, elevator shafts and other building openings due pressure differences induced by stack effect, buoyancy, or wind. Installation of smoke dampers can help inhibit smoke movement through HVAC ducts, but not the other paths.

The term "smoke management", as used in this paper, includes all methods that can be used singly or in combination to modify smoke movement for the benefit of occupants or firefighters or for the reduction of property damage. The use of barriers, smoke vents, and smoke shafts are traditional methods of smoke management. The effectiveness of barriers are limited to the extent to which they are free of leakage paths. Smoke vents and smoke shafts are limited to the extent that smoke must be sufficiently buoyant to overcome any other driving forces that could be present. In the last few decades, fans have been employed with the intent of overcoming the limitations of traditional approaches. The mechanisms of compartmentation, dilution, air flow, pressurization, and buoyancy are used by themselves or in combination to manage smoke conditions in fire situations. These mechanisms are discussed in the sections below.

5. COMPARTMENTATION

Barriers with sufficient fire endurance to remain effective throughout a fire exposure have a long history of providing protection against fire spread. In such fire compartmentation, the walls, partitions, floors, doors, and other barriers provide some level of smoke protection to spaces remote from the fire. This section discusses the use of passive compartmentation, while the use of compartmentation in conjunction with pressurization is discussed later. The extent to which smoke leaks through such barriers depends on the size and shape of the leakage paths in the barriers and the pressure difference across the paths.

Methods for determining the rate of smoke leakage through barriers and the resulting levels of hazard are a topic of ongoing development. Such hazard analysis (Bukowski et al. 1989) incorporates the use of computer models of smoke transport, people movement and toxicity. For an example of hazard analysis in multi-story buildings, readers are referred to Klote, Nelson, Deal and Levin (1992).

6. DILUTION

Dilution of smoke is sometimes referred to as smoke purging, smoke removal, smoke exhaust, or smoke extraction. Dilution can be used to maintain acceptable gas and particulate concentrations in a compartment subject to smoke infiltration from an adjacent space. This can be effective if the rate of smoke leakage is small compared to either the total volume of the safeguarded space or the rate of purging air supplied to and removed from the space. Also, dilution can be beneficial to the fire service for removing smoke after a fire has been extinguished. Sometimes, when doors are opened, smoke will flow into areas intended to be protected. Ideally, such occurrences of open doors will only happen for short periods of time during evacuation. Smoke that has entered spaces remote from the fire can be purged by supplying outside air to dilute the smoke.

6.1 Dilution Away From the Fire

The following is a simple analysis of smoke dilution for spaces in which there is no fire. At time zero ($t = 0$), a compartment is contaminated with some concentration of smoke and no further smoke flows into the compartment or is generated within it. Also, the contaminant is considered uniformly distributed throughout the space. The time for contaminant dilution can be expressed as:

$$t = \frac{1}{a} \log_e \left(\frac{C}{C_o} \right) \quad (1)$$

where:

C_o = initial concentration of contaminant;

C = concentration of contaminant at time, t ;

a = dilution rate in number of air changes per minute;

t = time after smoke stops entering space or time after which smoke production has stopped, minutes; and

e = constant approximately 2.718.

The concentrations C_o and C must be expressed in the same units, and they can be any units appropriate for the particular contaminant being considered. McGuire, Tamura, and Wilson (1971) evaluated the maximum levels of smoke obscuration from a number of fire tests and a number of proposed criteria for tolerable levels of smoke obscuration. Based on this evaluation, they state that the maximum levels of smoke obscuration are greater by a factor of 100 than the tolerance levels of smoke obscuration. Thus, they indicate that a space can be considered "reasonably safe" with respect to smoke obscuration, if the concentration of contaminants in the space is less than about 1% of the concentration in the immediate fire area. It is obvious that such dilution would also reduce the concentrations of toxic smoke components. Toxicity is a more complicated problem, and no parallel statement has been made regarding dilution needed to obtain a safe atmosphere with respect to toxic gases.

Equation (1) can be used to estimate the time required to purge smoke after a fire has been completely extinguished. If the HVAC system is capable of 6 air changes per hour ($a = 0.1 \text{ min}^{-1}$) and a dilution to 1% ($C_o/C = 100$) is desired, then a dilution time of 46 minutes can be calculated from equation (1).

6.2 Caution About Dilution Near a Fire

Many people have unrealistic expectations about what dilution can accomplish in the fire space. There is no theoretical or experimental evidence that using a building's HVAC system for smoke dilution will result in any significant improvement in tenable conditions within the fire space. It is well known that HVAC systems promote a considerable degree of air mixing within the spaces they serve. Because of this and the fact that very large quantities of smoke can be produced by building fires, it is generally believed that dilution of smoke by an HVAC system in the fire space will not result in any practical improvement in the tenable conditions in that space. Thus it is recommended that smoke purging systems intended to improve hazard conditions within the fire space or in spaces connected to the fire space by large openings not be used.

7. PRESSURIZATION

Systems using pressurization produced by mechanical fans are referred to as smoke control in this paper and in NFPA 92A (1988). A pressure difference across a barrier can control smoke movement as illustrated in figure 3. Within the barrier is a door. The high pressure side of the door can be either a refuge area or an egress route. The low pressure side is exposed to smoke from a fire. Airflow through the gaps around the door and through construction cracks prevents smoke infiltration to the high pressure side. The two most common applications of smoke control by pressurization are zoned smoke control and pressurized stairwells. Further information about pressurization for smoke control is presented by Klote and Milke (1992) and NFPA 92A.

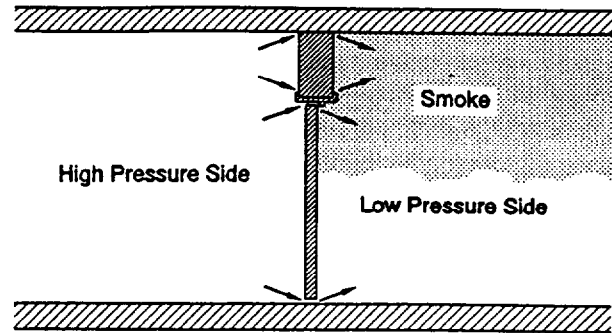

Figure 3. Pressure Difference Across a Barrier of a Smoke Control System Preventing Smoke Infiltration to the High Pressure Side of the Barrier.

7.1 Zoned Smoke Control

A building can be divided into a number of smoke zones, each separated from the others by partitions and floors. In the event of a fire, pressure differences produced by mechanical fans are used to limit the smoke spread to the zone in which the fire initiated. The concentration of smoke in this zone goes unchecked. Accordingly, in zoned smoke control systems, it is intended that occupants evacuate the smoke zone as soon as possible after fire detection.

Frequently, each floor of a building is chosen to be a separate smoke control zone. However, a smoke control zone can consist of more than one floor, or a floor can consist of more than one smoke control zone. When the fire floor is exhausted and only adjacent floors are pressurized, the system is sometimes called a "pressure sandwich." Zoned smoke control can use fans that belong to the HVAC system or fans that are specifically dedicated to smoke control.

When the HVAC system serves many zones (figure 4), smoke control is achieved by the following sequence upon fire detection: (1) the smoke damper in the supply duct to the smoke zone is closed, (2) the smoke dampers in the return duct to nonsmoke zones are closed, and (3) if the system has a return air damper, it is closed.

Precautions must be taken to minimize the probability of smoke feedback into the supply air system. Exhaust air outlets must be located away from outside air intakes. To conserve energy, most HVAC systems in modern commercial buildings have the capability of recirculating air within building spaces. During normal HVAC operation, the return damper is completely or partially open to allow air from building spaces to be mixed with outside air. This mixture is conditioned and supplied to building spaces to maintain desired temperature and humidity. During smoke control operation the return damper must be tightly closed to prevent smoke feedback into the supply air as is illustrated in figure 5.

The particular class of damper specified should be selected based on the requirements of the application. For example, the dampers in the supply and return ducts shown in figure 4 can have some leakage without adversely affecting smoke control system performance. Thus a designer might select class II, III or IV smoke dampers for such an application. Further, a designer might choose class I dampers for applications that require

a very tight damper (for example the return damper illustrated in figure 5).

7.2 Pressurized Stairwells

Many pressurized stairwells are designed and built with the goal of providing a smoke-free escape route in the event of a building fire. A secondary objective is to provide a smoke-free staging area for fire fighters. On the fire floor, the design objective is to maintain a pressure difference across a closed stairwell door to prevent smoke infiltration into the stairwell. A single injection system is one that has pressurization air supplied to the stairwell at one location. For tall stairwells single injection systems can fail when a few doors near the air supply injection point are open. All of the pressurization air can be lost through these open doors, and the system will then fail to maintain positive pressures across doors further from the injection point. To prevent this, some smoke control designers limit the height of single injection stairwells to eight stories; however, other designers feel this limit can be extended to twelve stories. An alternative is multiple injection as shown in figure 6.

Pressure fluctuations due to doors opening and closing must be taken into account in the design of pressurized stairwells. When any stair door opens in a simple stairwell pressurization system, the pressure differences across closed doors drops significantly. However, opening the exterior stairwell door results in the largest pressure drop. This is because the airflow through the exterior doorway goes directly to the outside, while airflow through other open doorways must also go through other building paths to reach the outside. The increased flow resistance of the building means that less air flows through other doorways than flows through the open exterior doorway. The flow through the exterior doorway can be three to ten times that through other doorways, and the relative flow through the exterior doorway is greatest for tightly constructed buildings. Thus the exterior stairwell door is the greatest cause of pressure fluctuations due to door opening and closing.

Numerous systems have been developed to deal with pressure fluctuations, and Klote and Milke (1992) provide a detailed description of many of these systems. Performance of pressurized stairwells depends on many factors including building leakage, system approach, and outside air temperature. The computer program ASCOS (Analysis of Smoke Control Systems) presented by Klote and Milke can be used to evaluate such systems, as well as, the need for multiple injection.

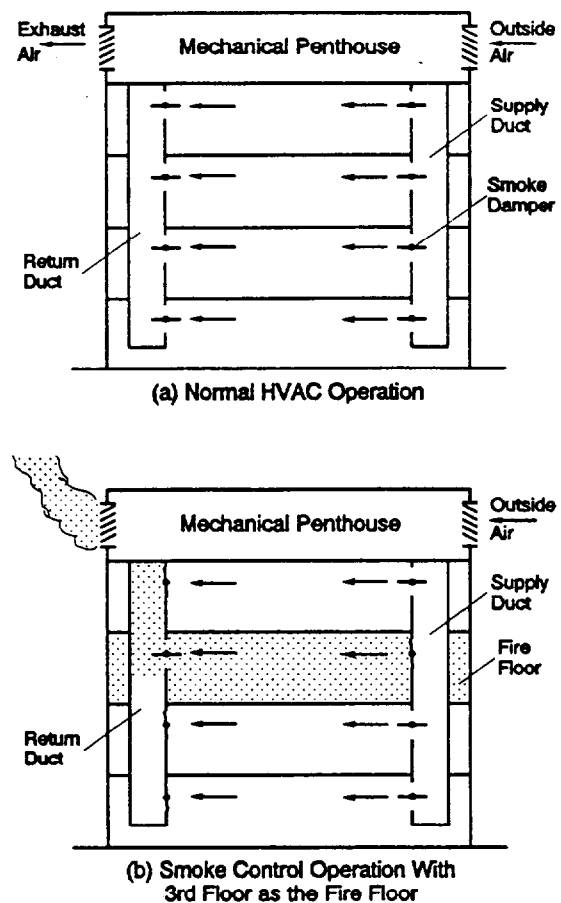

Figure 4. Schematic of Zoned Smoke Control System Using an HVAC System that Serves Many Smoke Control Zones.

7.3 Activation of Pressurization Systems

Probably, system activation is the major area of disagreement in the field of smoke control. Primarily, this disagreement is about automatic activation versus manual activation. In the early days of smoke control, there was general agreement that activation of "pressure sandwich" systems should be automatic upon alarm from smoke detectors. Automatic activation by smoke detectors located in building spaces has the clear advantage of fast response.

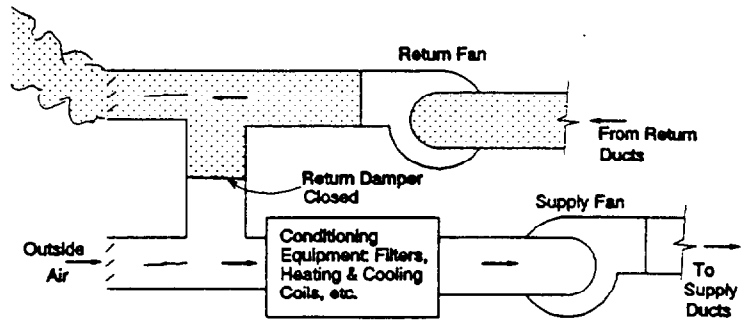

Figure 5. HVAC System With Recirculation Capability in the Smoke Control Mode.

Some building designers and fire service officials began to realize that smoke detectors could go into alarm on a floor far away from the fire. Thus automatic activation by smoke detectors could result in pressurization of the zone in which the fire occurred. This would result in the opposite of the desired operation, that is smoke would be forced into other zones. As a result, a vocal minority of officials feel that smoke control should only be activated manually by fire fighters after they are sure of the fire location. However, many involved professionals are concerned that such manual activation could be so late in the fire development that significant hazard to life and damage to property would result.

The most recent view on the subject is that zoned smoke control should be automatically activated by an alarm from either heat detectors or sprinkler water flow. This can only be accomplished if the detector or sprinkler zones are compatible with the smoke control zones. Using heat detector or sprinkler flow signals for activation increases the likelihood of proper identification of the fire zone. For smoldering fires, this approach would result in significantly longer response time. However, for flaming fires, it is believed that the response time with this approach would be short enough so that significant benefit would be realized by the operation of the smoke control system. It is hoped that advances in smoke detector technology and application will improve significantly the ability of these detectors to positively identify the fire zone.

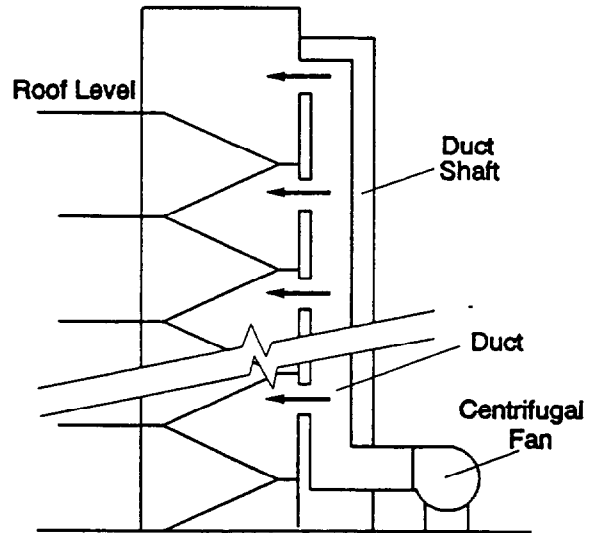

Figure 6. Stairwell Pressurization by Multiple Injection With the Fan Located at Ground Level.

Throughout all this controversy, there has been complete agreement that zoned smoke control should not be activated by alarms from manual stations (pull boxes). The reason can be illustrated by the scenario of a man who on observing a fire on an upper floor of a building, decides that the first thing he should do is to get out of the building. On the way down the stairs, he thinks of his responsibility to the other occupants. He stops on a lower floor long enough to actuate a manual station. If that alarm activated the smoke control system, the wrong zone would be identified as the fire zone.

Because of the long response time and the maintenance problem of clogging with airborne particles, it is generally agreed that smoke detectors located in HVAC ducts should not be the primary means of smoke control system activation. A means of activation of higher reliability and quicker response time is needed. However, an alarm from a duct-located detector can be used in addition to such a primary means of activation. A signal from only this secondary means might be unusual, but it should be able to activate the smoke control system.

Most stairwell pressurization systems operate in the same manner regardless where the fire is located. Therefore, it generally is agreed that most stairwell pressurization systems can be activated by the alarm of any device located within the building. It is recommended that zoned smoke control systems be equipped with a remote control center from which the smoke control system can be manually overridden. Such a control center should be easily identifiable and accessible to the fire department.

8. AIRFLOW

Airflow has been used extensively to manage smoke from fires in subway, railroad and highway tunnels. Large flow rates of air are needed to control smoke flow, and these flow rates can supply additional oxygen to the fire. Because of the need for complex controls, airflow is not used so extensively in buildings. The control problem consists of having very small flows when a door is closed and then having those flows increase significantly when that door opens. This section presents the basics of smoke control by airflow which demonstrate why this technique is not recommended, except when the fire is suppressed or in the rare cases when fuel can be restricted with confidence.

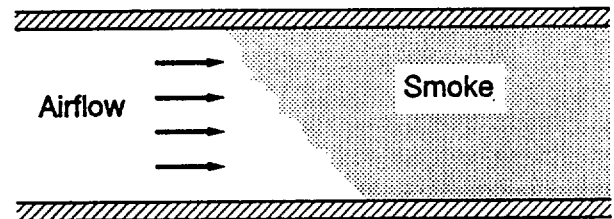

Figure 7. Critical Velocity to Prevent Smoke Backflow in a Corridor.

Thomas (1970) determined that airflow in a corridor in which there is a fire can almost totally prevent smoke from flowing upstream of the fire. As illustrated in figure 7, the smoke forms a surface sloped into the direction of the oncoming airflow. Molecular diffusion is believed to result in transfer of trace amounts of smoke producing no hazard but just the smell of smoke upstream. There is a minimum velocity below which smoke will flow upstream. For an upstream air temperature of 27° C (81° F), Thomas's empirical relation for this critical velocity is

$$V_k = K_v \left(\frac{E}{W} \right)^{1/3} \quad (2)$$

where:

V_k = critical air velocity to prevent smoke backflow, m/s (fpm);

E = energy release rate into corridor, kW (Btu/s);

W = corridor width, m (ft);

K_v = coefficient, 0.292 (87.1).

This relation can be used when the fire is located in the corridor or when the smoke enters the corridor through an open doorway, air transfer grille, or other opening. While the critical velocities calculated from equations (2) are approximate, they are indicative of the kind of air velocities required to prevent smoke backflow from fires of different sizes.

The equation of Thomas can be used to estimate the air flow rate necessary to prevent smoke backflow through an open door in a boundary of a smoke control system. However, the oxygen supplied is a concern. Hugget (1980) evaluated the oxygen consumed for combustion of numerous natural and synthetic solids. He found that for most materials that are involved in building fires, the energy released per unit of mass of oxygen consumed is approximately 13.1×10^6 J/kg (5630 Btu/lb). Air is 23.3% oxygen by weight. Thus if all the oxygen in a kg of air is consumed, 3.0 MJ of heat is liberated. Stated in English units: if all the oxygen in a pound of air is consumed, 1300 Btu of heat is liberated. The maximum fire size that can be supported if all the oxygen of an airflow is consumed is

$$E_m = K_a \rho V A \quad (3)$$

where:

- E_m = maximum heat release rate, kW (Btu/s);
- ρ = density of air upstream of fire, kg/m³ (lb/ft³);
- V = average velocity of airflow, m/s (fpm);
- A = cross sectional area of corridor, m² (ft²);
- K_a = coefficient, 3000 (21.6).

The problem with using airflow in an attempt to prevent smoke backflow is that the airflow has the potential to support an extremely large fire. For example in a corridor (or other opening) 0.91 m (3 ft) wide and 2.1 m (7 ft) high, equation (2) indicates that a velocity of 1.27 m/s (250 fpm) is needed to prevent smoke backflow in a 0.91 m (3 ft) wide corridor due to a wastebasket fire of 75 kW (71 Btu/s). However, this flow through the cross sectional area of the corridor can support a 9,400 kW (8,900 Btu/s) fire provided all the O₂ in the air is consumed. Thus the airflow to prevent smoke backflow of a 75 kW (71 Btu/s) fire has the potential to support 9,400 kW (8,900 Btu/s) fire. Table 2 lists this and other critical velocities and the maximum fires that would result if all the O₂ in the airflow were consumed. For all of the fires listed, the air needed to prevent smoke backflow can support extremely large fires.

In most locations of commercial and residential buildings, sufficient fuel (paper, cardboard, furniture, floor finishes, wall finishes, etc.) is present to support very large fires. Even when the amount of fuel is normally very small, short term fuel loads (during building renovation, material delivery, etc.) can be significant. Therefore, the use of airflow for smoke control is not recommended, except when the fire is suppressed or in the rare cases when fuel can be restricted with confidence.

9. BUOYANCY

Buoyancy of hot combustion gases is employed in both fan-powered and non-powered venting systems. Such fan-powered venting for large spaces is commonly employed for atriums and covered shopping malls (figure 8). Another concern is that the sprinkler flow will cool the smoke reducing buoyancy and thus system effectiveness. There is no question that sprinkler flow does cool smoke, but it is unknown as to what extent that cooling reduces effectiveness of fan-powered venting. Further research is needed in this area. However, the existing information can be used to develop new design information for fan-powered venting systems. Klote and Milke (1992) and NFPA 92B (1991) provides methods of design analysis for smoke management systems in large spaces such as atriums and shopping malls.

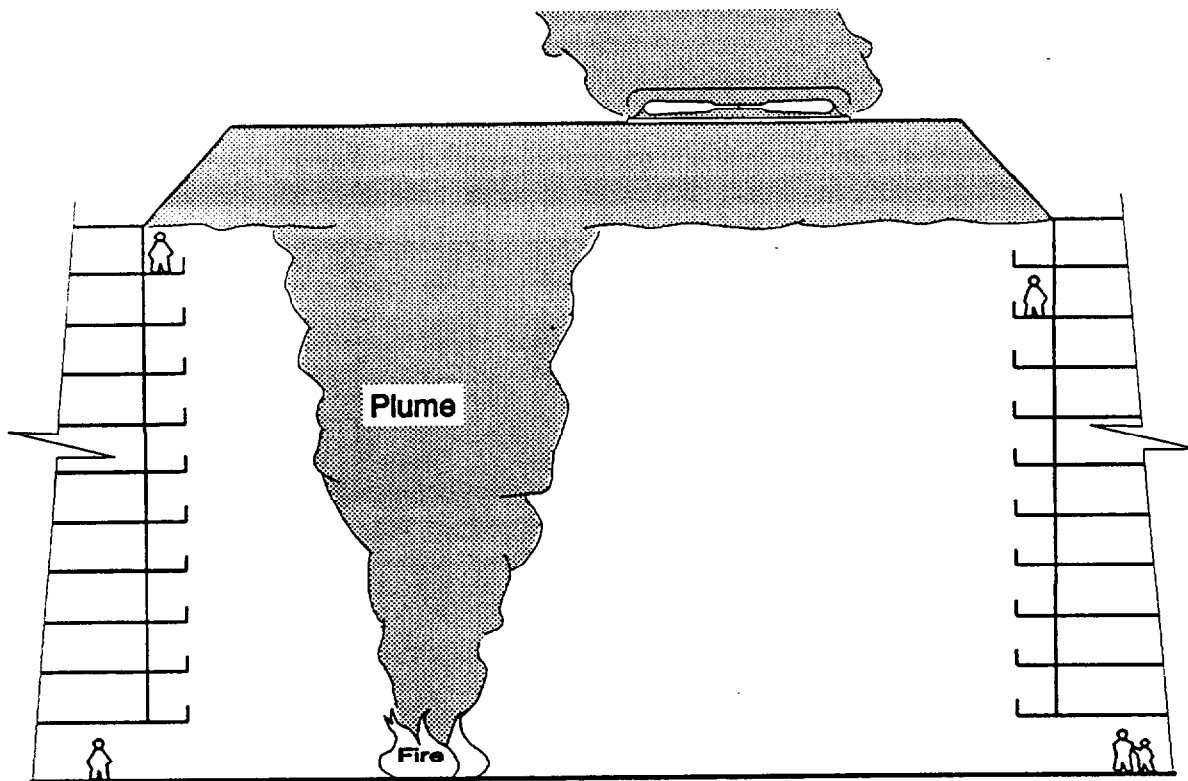

Figure 8. Atrium Smoke Exhaust System.

10. CONCLUDING REMARK

In this paper, a brief review of fire protection for HVAC systems and of smoke management has been presented. Before attempting to design or evaluate systems, engineers should carefully review the book by Klote and Milke (1992) and appropriate standards (e.g. NFPA 90A 1993, NFPA 92A 1988, NFPA 92B 1991).

11. REFERENCES

Bukowski, R.W., Peacock, R.D., Jones, W.W. and Forney, C.L., "Technical Reference Guide for HAZARD I Fire Hazard Assessment Method", NIST Handbook 146, Vol II, National Institute of Standards and Technology, Gaithersburg, MD, 1989.

Huggett, C., "Estimation of Rate of Heat Release by Means of Oxygen Consumption Measurements", Fire and Materials, Vol 4, No 2, June 1980.

Klote, J.H., Nelson, H.E., Deal, S., Levin, B.M. "Staging Areas for Persons with Mobility Limitations", NISTIR 4770, National Institute of Standards and Technology, 1992.

Table 2. Comparison of critical velocity maximum fire size if all the O₂ in the airflow is consumed¹

Description of Fire	kW		Critical Velocity ² , V_k		Fire Size If All O ₂ in Airflow is Consumed ³ , E_m	
	kW	Btu/s	m/s	fpm	kW	Btu/s
Wastebasket Fire	75	71	1.27	250	9,400	8,900
Arm Chair Fire	150	140	1.60	315	11,900	11,300
Loveseat Fire	900	850	2.91	573	21,600	20,500
Fully Involved Room Fire	2,400	2,300	4.03	794	29,900	28,400

¹This table is for a corridor or opening 0.91 m (3 ft) wide and 2.1 m (7 ft) high.

²The critical velocity is the velocity to prevent smoke backflow, and it is calculated from equation (2). For example, a velocity of 1.27 m/s (250 fpm) is needed to prevent smoke backflow in a 0.91 m (3 ft) wide corridor due to a wastebasket fire of 75 kW (71 Btu/s).

³The maximum fire size if all O₂ in the airflow is consumed is calculated from equation (3). For example, the flow of 1.27 m/s (250 fpm) over the cross sectional area of the corridor can support a 9,400 kW (8,900 Btu/s) fire provided all the O₂ in the air is consumed.

Klote, J.K. and Milke, J.A. "Design of Smoke Management Systems", American Society of Heating, Refrigerating and Air-conditioning Engineers, Atlanta, GA, 1992.

McGuire, J.H., Tamura, G.T. and Wilson, A.G. "Factors in Controlling Smoke in High Buildings", ASHRAE Symposium Bulletin - Fire Hazards in Buildings, San Francisco, CA, 19-22 Jan 1970, pp 8-13, 1971.

NBFU "Smoke Hazards of Air-Conditioning Systems", NFPA Quarterly, Vol 33, No 2, pp 113-122, 1939.

NFPA 92A "Recommended Practice for Smoke Control Systems", National Fire Protection Association, Quincy, MA, 1988.

NFPA 92B "Guide for Smoke Management Systems in Malls, Atria, and Large Areas", National Fire Protection Association, Quincy, MA, 1991.

NFPA 90A "Standard for the Installation of Air Conditioning and Ventilating Systems", National Fire Protection Association, Quincy, MA, 1993.

SMACNA "HVAC Duct System Design", Sheet Metal and Air Conditioning Contractors' Association, Inc., Chantilly, VA, 1981.

SMACNA "Fire, Smoke, and Radiation Damper Installation Guide for HVAC Systems", Sheet Metal and Air Conditioning Contractors' Association, Inc., Chantilly, VA, 1986.

Thomas, P.H. "Movement of Smoke in Horizontal Corridors Against an Air Flow", Institute of Fire Engineers Quarterly, 30(77), pp. 45-53, 1970.

UL 555 "Fire Dampers", UL 555, Underwriters Laboratories, Inc., Northbrook, IL, 1990.

UL 555S "Leakage Rated Dampers for Use in Smoke Control Systems", Underwriters Laboratories, Inc., Northbrook, IL, 1983.

NIST-114 (REV. 6-93) ADMAN 4.09	U.S. DEPARTMENT OF COMMERCE NATIONAL INSTITUTE OF STANDARDS AND TECHNOLOGY	(ERB USE ONLY) ERB CONTROL NUMBER DIVISION PUBLICATION REPORT NUMBER NISTIR 5227 CATEGORY CODE PUBLICATION DATE July 1993 NUMBER PRINTED PAGES
MANUSCRIPT REVIEW AND APPROVAL		

INSTRUCTIONS: ATTACH ORIGINAL OF THIS FORM TO ONE (1) COPY OF MANUSCRIPT AND SEND TO THE SECRETARY, APPROPRIATE EDITORIAL REVIEW BOARD.

TITLE AND SUBTITLE (CITE IN FULL)
 Air Moving Systems and Fire Protection

CONTRACT OR GRANT NUMBER _____ TYPE OF REPORT AND/OR PERIOD COVERED _____

AUTHOR(S) (LAST NAME, FIRST INITIAL, SECOND INITIAL)
 Klote, John H.

PERFORMING ORGANIZATION (CHECK (X) ONE BOX)
 NIST/GAITHERSBURG
 NIST/BOULDER
 JILA/BOULDER

LABORATORY AND DIVISION NAMES (FIRST NIST AUTHOR ONLY)
 Building and Fire Research Laboratory - 864

SPONSORING ORGANIZATION NAME AND COMPLETE ADDRESS (STREET, CITY, STATE, ZIP)

PROPOSED FOR NIST PUBLICATION

<input type="checkbox"/> JOURNAL OF RESEARCH (NIST JRES)	<input type="checkbox"/> MONOGRAPH (NIST MN)	<input type="checkbox"/> LETTER CIRCULAR
<input type="checkbox"/> J. PHYS. & CHEM. REF. DATA (JPCRD)	<input type="checkbox"/> NATL. STD. REF. DATA SERIES (NIST NSRDS)	<input type="checkbox"/> BUILDING SCIENCE SERIES
<input type="checkbox"/> HANDBOOK (NIST HB)	<input type="checkbox"/> FEDERAL INF. PROCESS. STDS. (NIST FIPS)	<input type="checkbox"/> PRODUCT STANDARDS
<input type="checkbox"/> SPECIAL PUBLICATION (NIST SP)	<input type="checkbox"/> LIST OF PUBLICATIONS (NIST LP)	<input type="checkbox"/> OTHER _____
<input type="checkbox"/> TECHNICAL NOTE (NIST TN)	<input checked="" type="checkbox"/> NIST INTERAGENCY/INTERNAL REPORT (NISTIR)	

PROPOSED FOR NON-NIST PUBLICATION (CITE FULLY) _____ U.S. FOREIGN

PUBLISHING MEDIUM
 PAPER CD-ROM
 DISKETTE (SPECIFY) _____
 OTHER (SPECIFY) _____

SUPPLEMENTARY NOTES

ABSTRACT (A 2000-CHARACTER OR LESS FACTUAL SUMMARY OF MOST SIGNIFICANT INFORMATION. IF DOCUMENT INCLUDES A SIGNIFICANT BIBLIOGRAPHY OR LITERATURE SURVEY, CITE IT HERE. SPELL OUT ACRONYMS ON FIRST REFERENCE.) (CONTINUE ON SEPARATE PAGE, IF NECESSARY.)

The fire hazards associated with heating, ventilating, and air conditioning (HVAC) systems are significant. Protection is needed from the spread of fire and smoke due to both fires starting inside an HVAC system and fires starting outside an HVAC system. Materials for HVAC components are restricted, and fire dampers and smoke dampers are needed. To provide smoke protection, an HVAC system can be shut down or it can be put into a special smoke control mode of operation. Smoke from building fires can be managed by the mechanisms of compartmentation, dilution, air flow, pressurization, and buoyancy.

KEY WORDS (MAXIMUM OF 9; 28 CHARACTERS AND SPACES EACH; SEPARATE WITH SEMICOLONS; ALPHABETIC ORDER; CAPITALIZE ONLY PROPER NAMES)
 air conditioning; air movement; fire protection; fire safety; heating; smoke control; stairwells; ventilation systems

AVAILABILITY
 UNLIMITED FOR OFFICIAL DISTRIBUTION - DO NOT RELEASE TO NTIS
 ORDER FROM SUPERINTENDENT OF DOCUMENTS, U.S. GPO, WASHINGTON, DC 20402
 ORDER FROM NTIS, SPRINGFIELD, VA 22161

NOTE TO AUTHOR(S): IF YOU DO NOT WISH THIS MANUSCRIPT ANNOUNCED BEFORE PUBLICATION, PLEASE CHECK HERE